

**Falcon**<sup>®</sup>

Surgical  
Instruments



32

UROLOGY

UROLOGIE  
UROLOGÍA  
UROLOGIE  
UROLOGIA

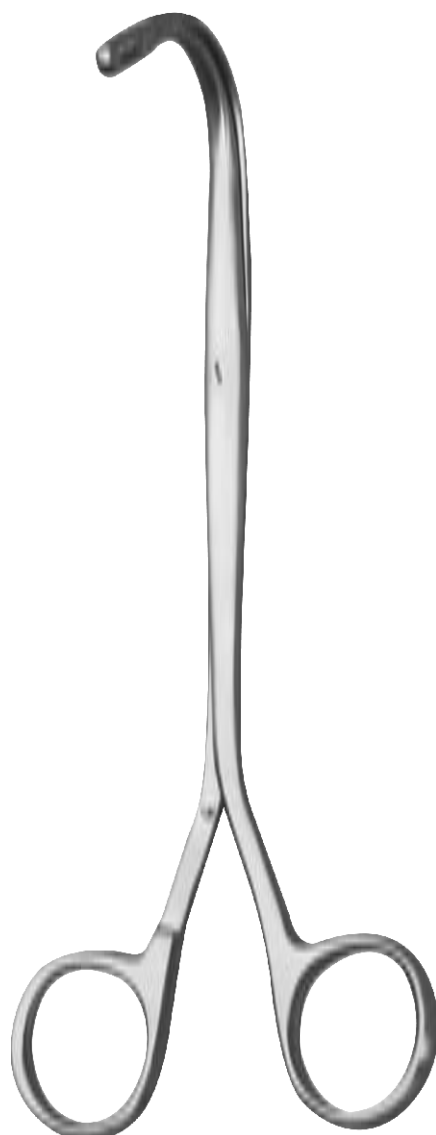





**Kidney Stone Forceps**

Nierensteinzangen  
Pinzas para cálculos renales

Pinces pour les calculs du bassinet  
Pinze per calcoli renali

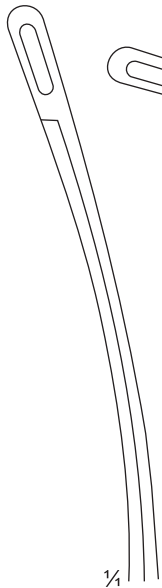

1  
32-001-23  
23 cm / 9"

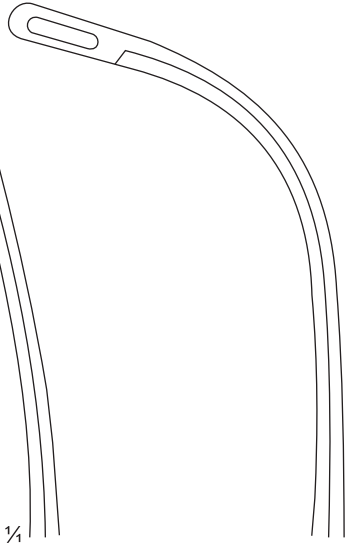

2  
32-002-22  
22 cm / 8¾"

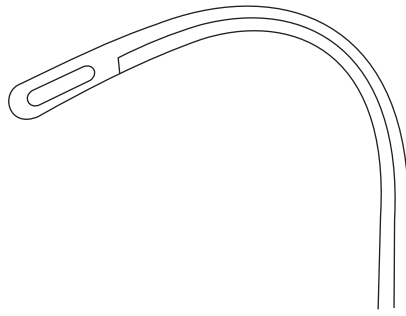

3  
32-003-22  
22 cm / 8¾"

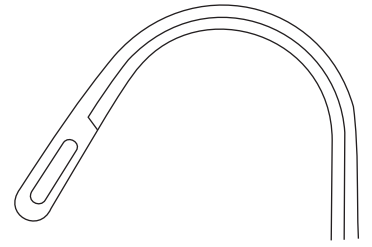

4  
32-004-22  
22 cm / 8¾"

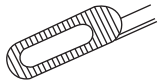

Randall  
32-001-23 - 32-006-19

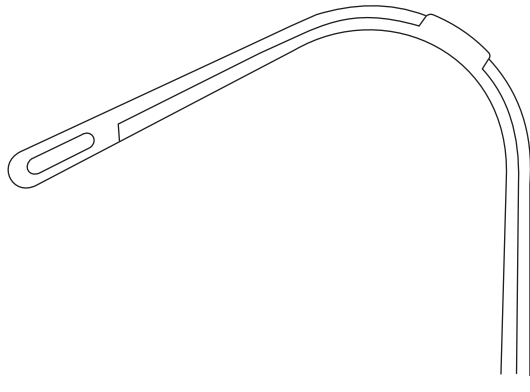

5  
32-005-19  
19 cm / 7½"

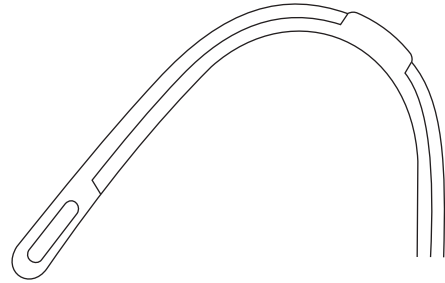

6  
32-006-19  
19 cm / 7½"

**Catheter Guides, Nephrostomy Forceps**

Kathetereinführinstrumente, Nierenfistelzangen  
Mandriles para catéteres, Pinzas para nefrostomía

Mandrins pour sondes urétrales, Pincas à néphrostomie  
Mandrini per sonde uretrali, Pinze per nefrostomia



**Sokeland**  
32-017-24  
24 cm / 9½"  
Catheter Introducer



**Hirth**  
32-019-18  
18 cm / 7"  
Catheter Introducer



**Kocher**  
32-022-26  
26.5 cm / 10½"

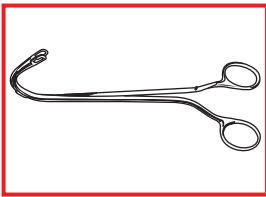

### Nephrostomy Forceps

Nierenfistelzangen  
Pinzas para nefrostomía

Pinces à néphrostomie  
Pinze per nefrostomia



**Ureter Clamps**

Ureterklemmen  
Pinzas clamps para ureter

Pinces-clamps á uretére  
Pinze per uretere

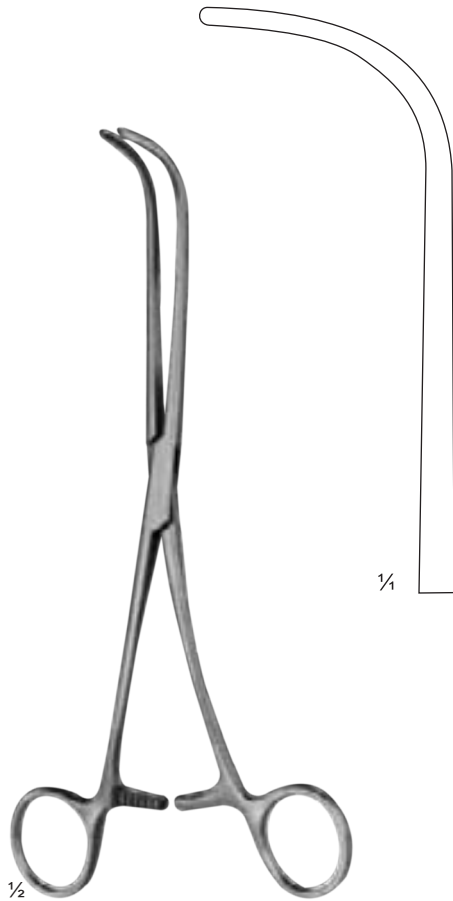
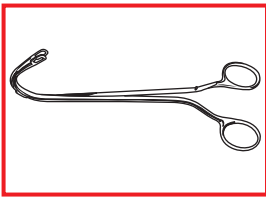

$\frac{1}{2}$   
**Lurz**  
32-035-01  
21cm / 8 $\frac{1}{4}$ "

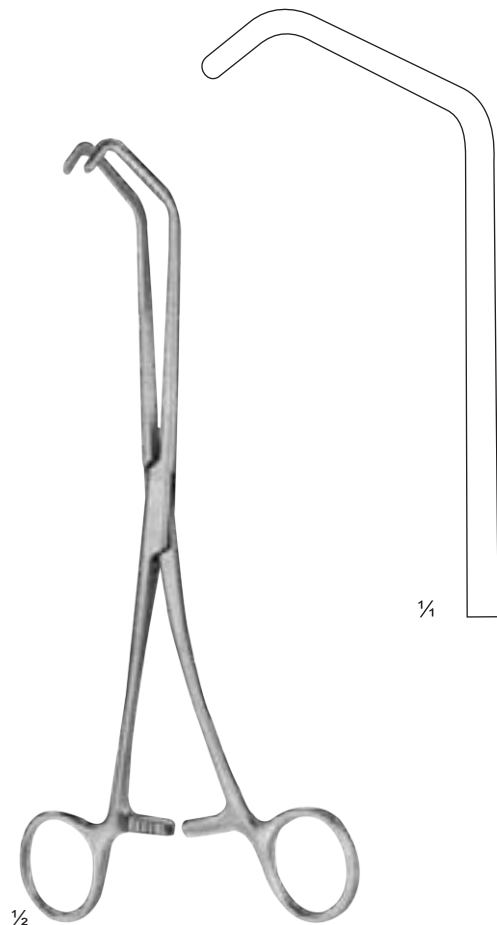

$\frac{1}{2}$   
**Lurz**  
32-035-02  
21 cm / 8 $\frac{1}{4}$ "

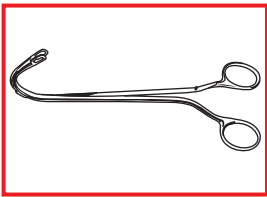

**Gall Stone Probes, Gall Duct Dilators**

Gallensteinsonden, Gallenkanal-Dilatatoren

Explorateurs à calculs biliaires, Dilatateurs à voies biliaires

Exploradores para cálculos biliares, Dilatadores para conductos biliares

Sonde per calcoli biliari, Dilatatori per condotti biliari

Fig. 1  
32-042-01  
1 mm ø

Fig. 2  
32-042-02  
2 mm ø

Fig. 3  
32-042-03  
3 mm ø

Fig. 4  
32-042-04  
4 mm ø

Fig. 5  
32-042-05  
5 mm ø

Fig. 6  
32-042-06  
6 mm ø

Fig. 7  
32-042-07  
7 mm ø

Fig. 8  
32-042-08  
8 mm ø

Fig. 9  
32-042-09  
9 mm ø

Fig. 10  
32-042-10  
10 mm ø

Fig. 11  
32-042-11  
11 mm ø

Fig. 12  
32-042-12  
12 mm ø

Fig. 13  
32-042-13  
13 mm ø

32-044-28

32-046-28

32-048-28

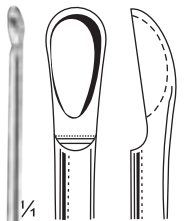

**Bakes**  
32-042-01 - 32-042-13  
30 cm / 12"  
malleable shaft

**Desjardins**  
32-044-28 - 32-048-28  
28 cm / 11"  
elastic

**Ochsner**  
32-050-38  
38 cm / 15"

**Moynihan**  
32-052-34  
34 cm / 13½"

**Gall Duct Dilators**

Gallenkanaldilatatoren  
Dilatadores para conducto biliar

Dilatateurs pour les voies biliaires  
Dilatatori per condotti biliari

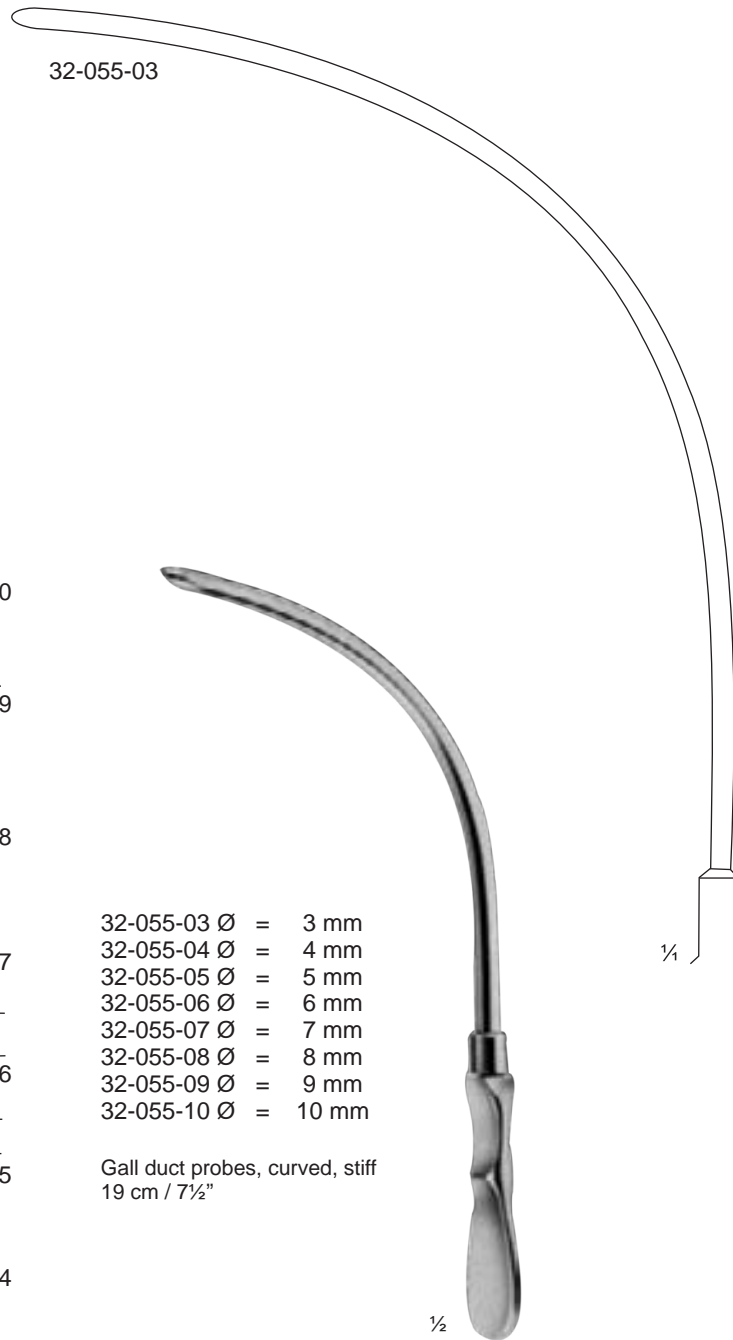

32-055-03

- 32-055-10
- 32-055-09
- 32-055-08
- 32-055-07
- 32-055-06
- 32-055-05
- 32-055-04

- 32-055-03 Ø = 3 mm
- 32-055-04 Ø = 4 mm
- 32-055-05 Ø = 5 mm
- 32-055-06 Ø = 6 mm
- 32-055-07 Ø = 7 mm
- 32-055-08 Ø = 8 mm
- 32-055-09 Ø = 9 mm
- 32-055-10 Ø = 10 mm

Gall duct probes, curved, stiff  
19 cm / 7½"

½





**Gall Stone Forceps**

Gallensteinzangen  
Pinzas para cálculos biliares

Pinces pour calculs biliaires  
Pinze per calcoli biliari

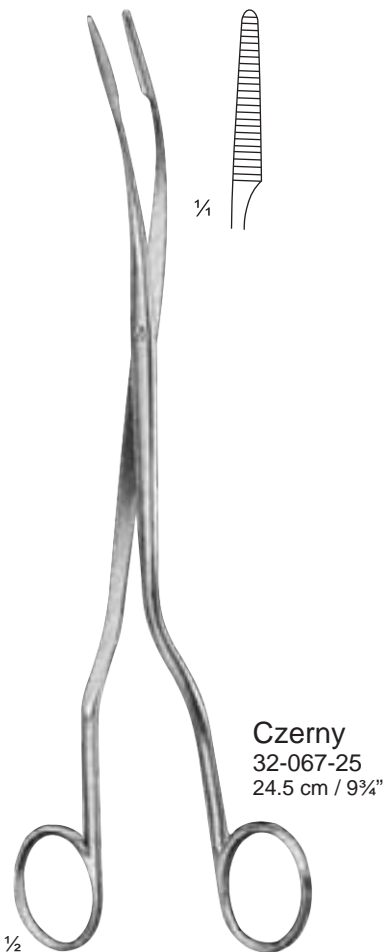

**Czerny**  
32-067-25  
24.5 cm / 9¾"

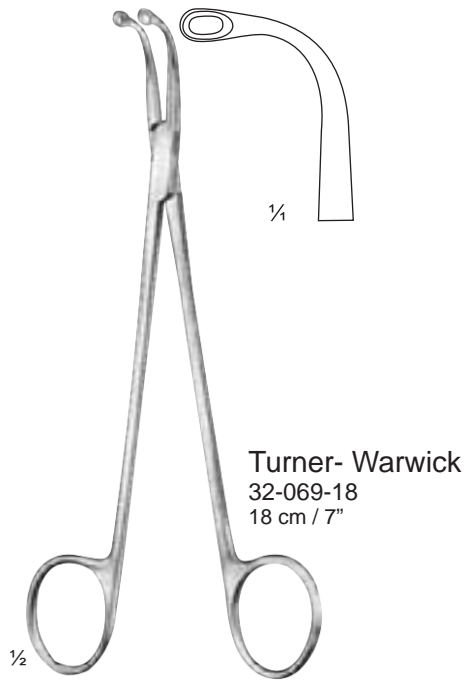

**Turner- Warwick**  
32-069-18  
18 cm / 7"

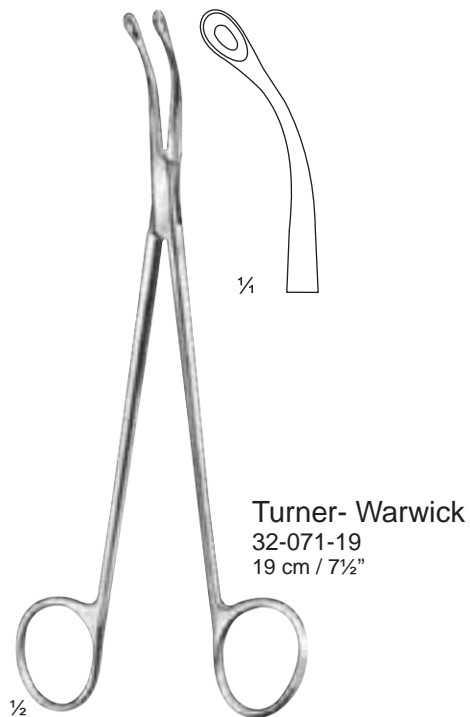

**Turner- Warwick**  
32-071-19  
19 cm / 7½"



**Mayo-Blake**  
32-074-20  
20 cm / 8"



**Mayo-Blake**  
32-077-20  
20 cm / 8"

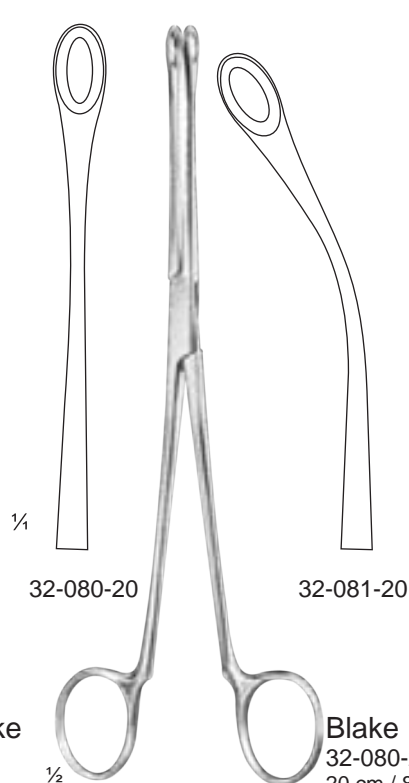

32-080-20

32-081-20

**Blake**  
32-080-20 - 32-081-20  
20 cm / 8"



**Gall Stone Forceps**

Gallensteinzangen  
Pinzas para cálculos biliares

Pinces pour calculs biliaires  
Pinze per calcoli biliari

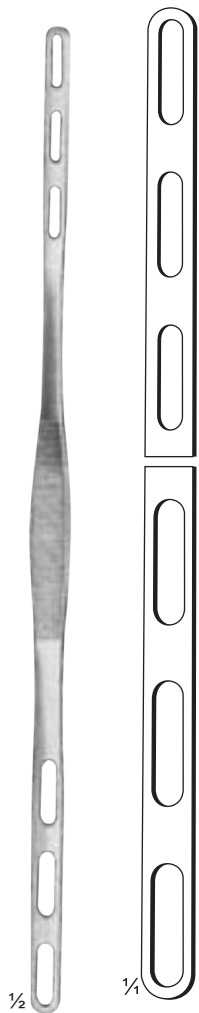

32-084-27  
26.5 cm / 10½"  
malleable



Desjardins  
23 cm / 9"  
32-087-23 = Fig. 1  
32-089-23 = Fig. 2



Mixer  
32-091-22  
22 cm / 8¾"



**Gall Stone Forceps**

Gallensteinzangen  
Pinzas para cálculos biliares

Pinces pour calculs biliaires  
Pinze per calcoli biliari

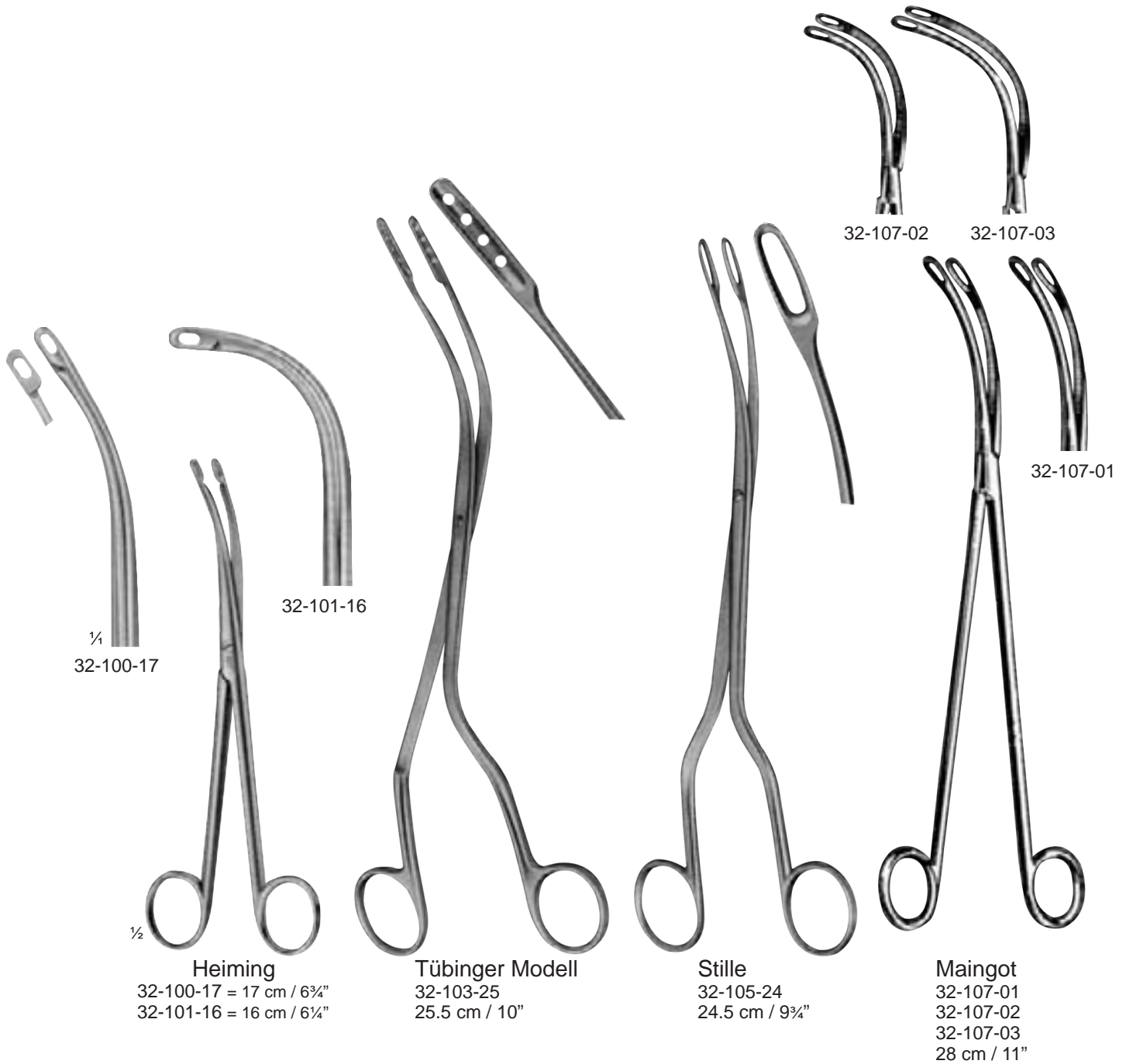

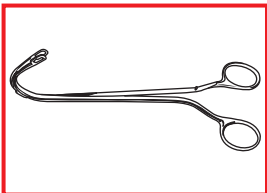

**Gall Stone Scoops**

Gallensteinlöffel  
Cucharas para cálculos biliares

Curettes pour calculs biliaires  
Pinze per calcoli biliari



**Luer-Koerte**  
32-112-01 - 32-112-08  
32 cm / 12 3/4"  
malleable

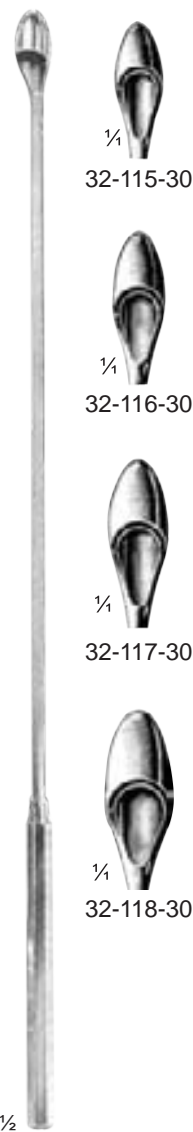
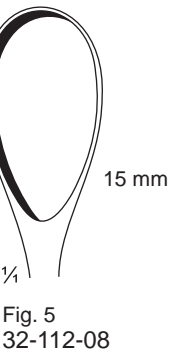
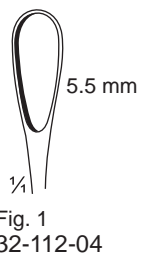
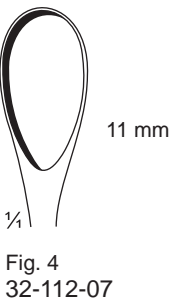
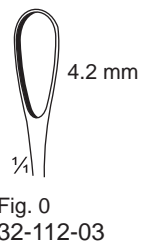
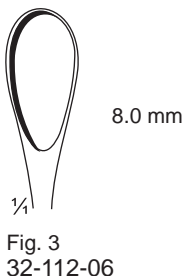
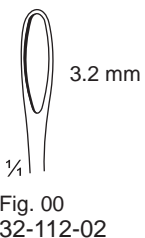
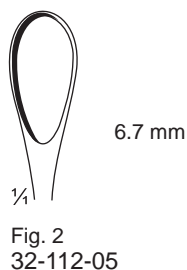
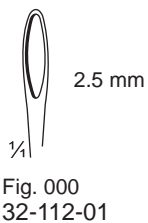

**Desjardins**  
32-115-30 - 32-118-30  
30 cm / 12"  
elastic

1/4  
32-115-30

1/4  
32-116-30

1/4  
32-117-30

1/4  
32-118-30



**Gall Stone Scoops**

Gallensteinlöffel  
Cucharas para cálculos biliares

Curettes pour calculs biliaires  
Pinze per calcoli biliari

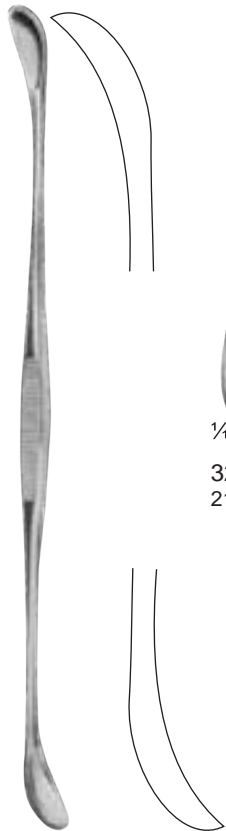

**Fergusson**  
32-124-21 - 32-124-23



1/4

32-124-21  
21.5 cm / 8 1/2"



1/4

32-124-22  
22 cm / 8 3/4"



1/4

32-124-23  
23.5 cm / 9 1/4"



1/2

**Moore**  
32-127-28  
28 cm / 11"



1/2

**Mayo**  
32-130-28  
28 cm / 11"



1/2

**Cheatle**  
32-133-34  
34 cm / 13 1/2"



**Prostatic Retractors**

Prostatahaken  
Separadores para próstata

Ecarteurs prostatiques  
Divaricatori prostatici

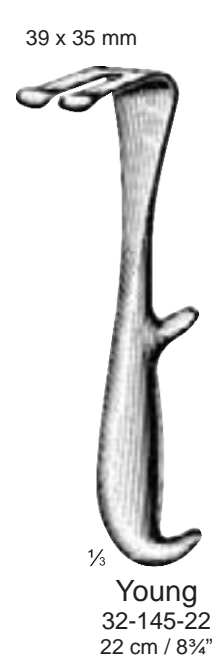
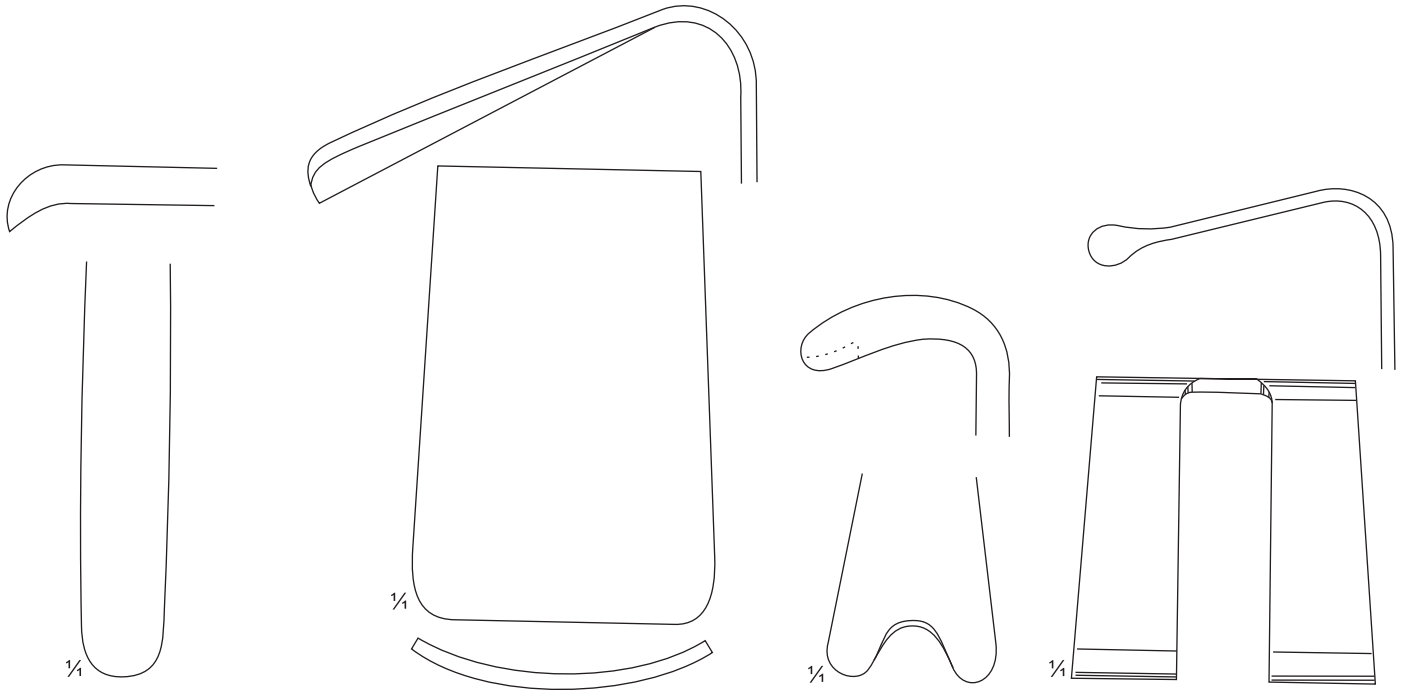



**Capsule Forceps, Ligature Carrying Forceps**

Kapselfasszangen, Fadenführungszange  
Pinzas capsulares, Pinza porta ligaduras

Pinces pour saisir les capsules, Pince porte-fil  
Pinze per afferrare capsule, Pinza porta-filo

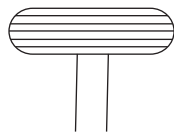

32-151-23  
23 cm / 9"

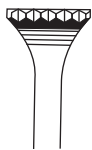

32-153-23  
23 cm / 9"  
9:9

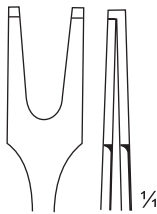

32-155-24  
24 cm / 9½"

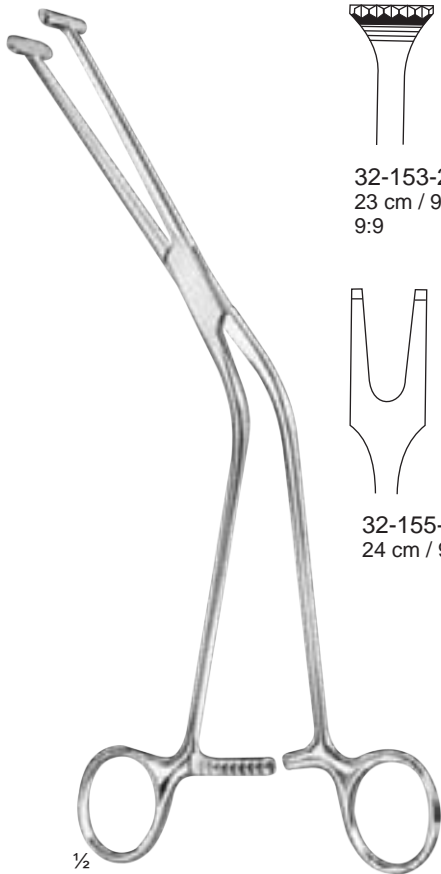

½

Millin  
32-151-23 - 32-155-24

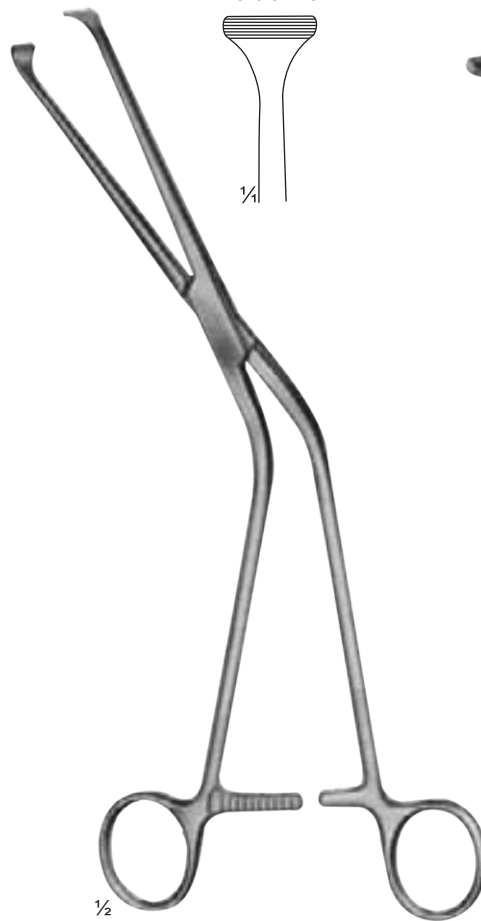

½

Millin  
32-157-24  
24.5 cm / 9¾"



½

Millin  
32-159-24  
23.5 cm / 9¼"

**Bladder Neck Spreader, Bladder Retractors**

Blasenhalsperrer, Blasenwundsperrer  
 Dilatador para el cuello vesical, Separadores vesicales

Ecarteur pour le col de la vessie, Ecarteurs vésicaux  
 Divaricatore del collo vescicale, Divaricatore vescicale



1/2

**Millin**  
 32-165-00  
 29 cm / 11 1/2"

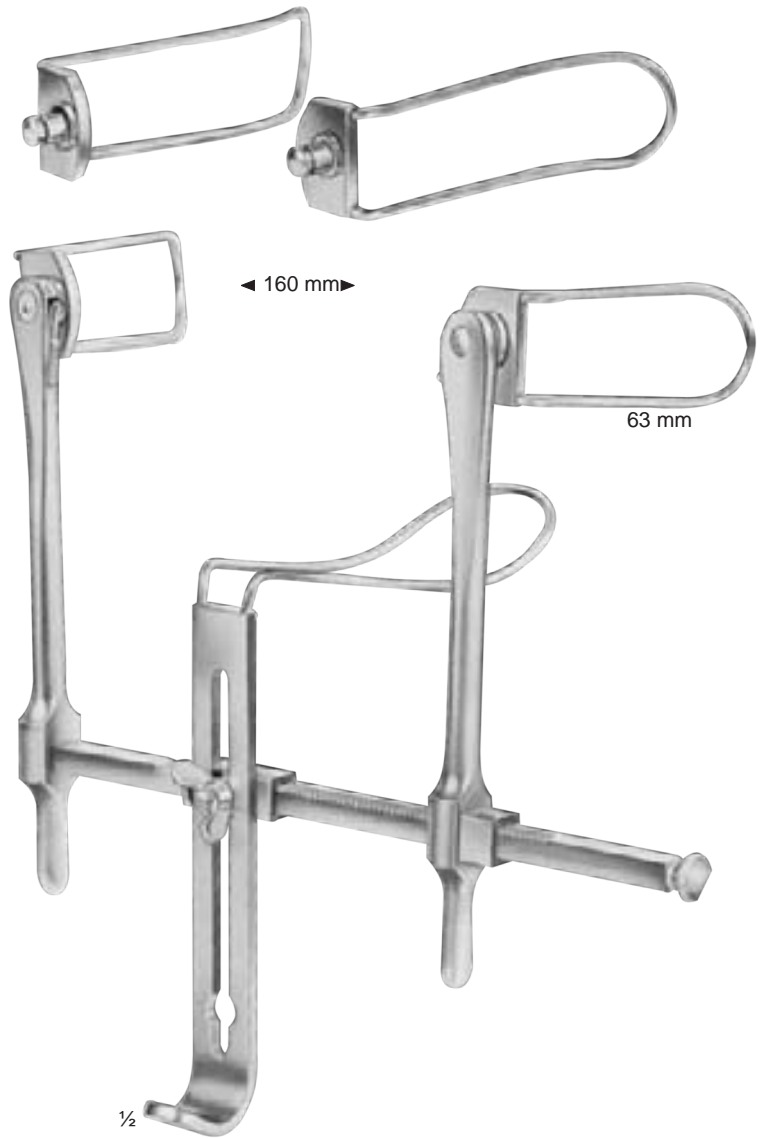

◀ 160 mm ▶

63 mm

1/2

**Gosset**  
 32-168-00



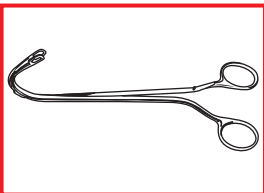

**Bladder Retractors**

Blasenwundsperrer  
Separadores vesicales

Ecarteurs vésicaux  
Divaricatore vescicale

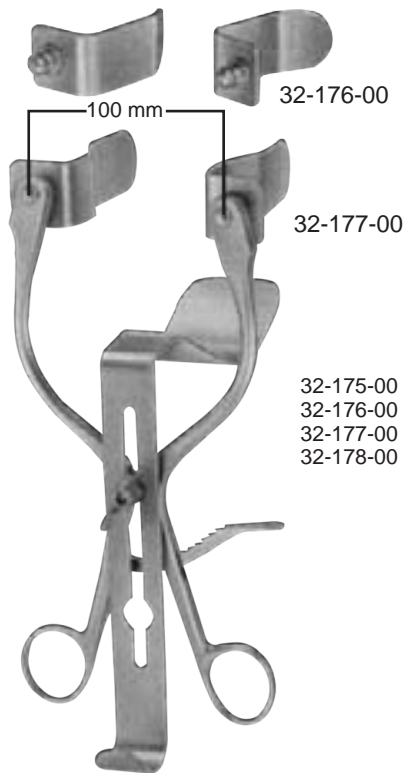

32-176-00

32-177-00

- 32-175-00 Spreader only
- 32-176-00 Side Blades 57 x 25 mm (pair)
- 32-177-00 Side Blades 82 x 25 mm(pair)
- 32-178-00 Center blade 105 x 45 mm

**Millin**  
32-180-00  
bladder retractor/complete

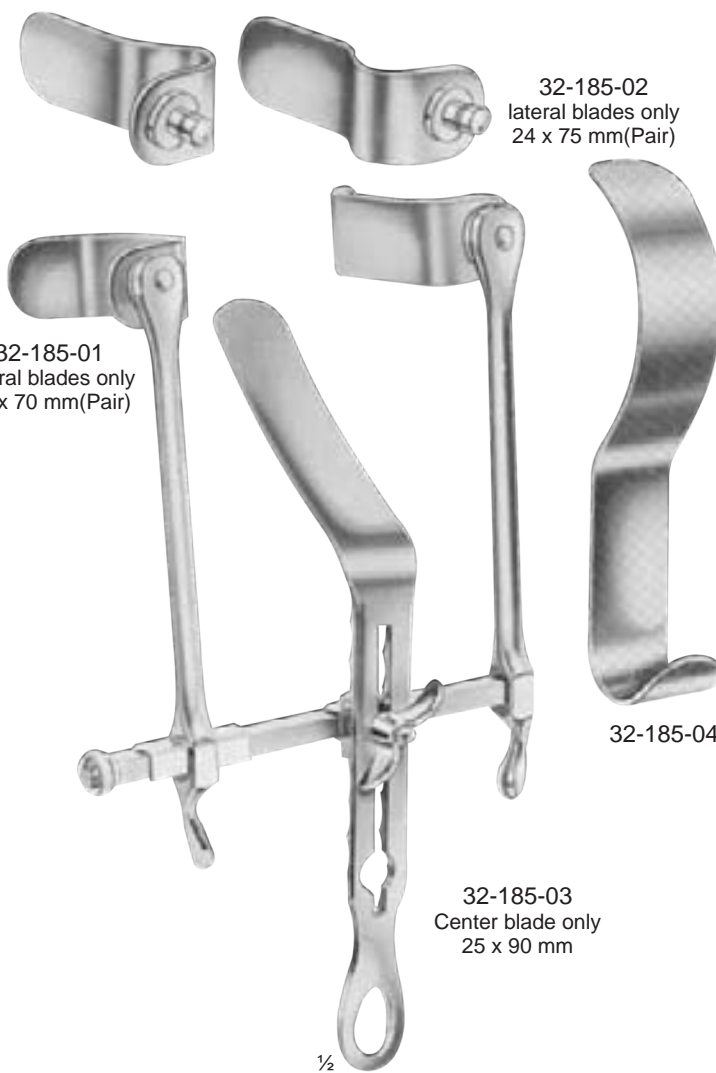

32-185-02  
lateral blades only  
24 x 75 mm(Pair)

32-185-01  
lateral blades only  
24 x 70 mm(Pair)

32-182-01  
27 x 60 mm  
Side Blades (Pair)

32-182-02  
Centre Blade

32-185-04

32-185-03  
Center blade only  
25 x 90 mm



1/2

**Legueu**  
32-182-00  
17 cm / 6 1/2"

**Thomson-Walker**  
32-185-00

**Bladder Retractors, Bladder Spatula**

Blasenwundsperrer, Blasenspatel  
 Separadores vesicales, Espátula vesical

Ecarteurs vésicaux, Spatule vésicale  
 Divaricatore vescicale, Spatole vescicali

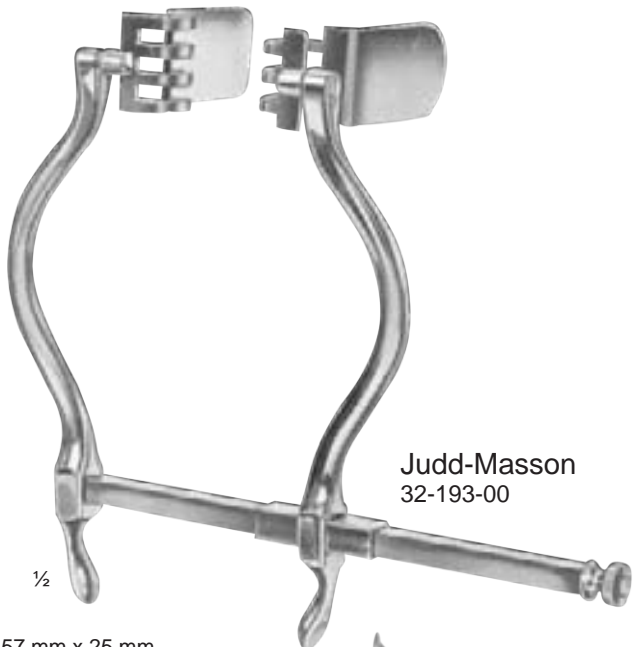
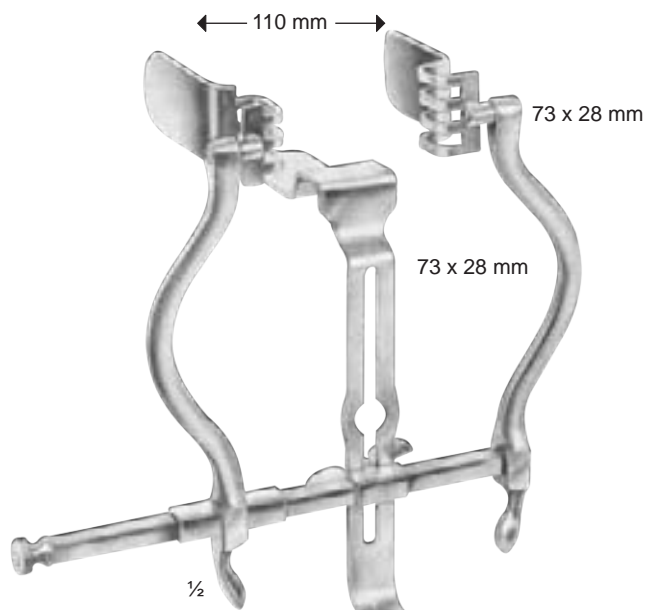
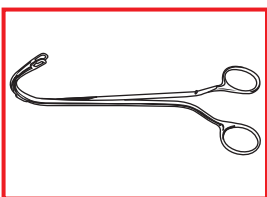

Judd-Masson  
32-190-00

- 32-200-01 2 Blades 57 mm x 25 mm
- 32-200-02 2 Blades 80 mm x 25 mm
- 32-200-03 1 Blade 120 mm x 45 mm



Legueu  
32-195-27  
27 cm / 10½"



Kocher  
32-197-26  
26 cm / 10¼"



Millin  
32-200-00

**Filiform Bougie, Urethral Sounds**

Gleitsonde, Harnröhrenbougies  
Sonda filiforme, Bujias uretrales

Bougie conductrice, Bougies urétrales  
Candeletta filiforme, Candelette dilatatrice

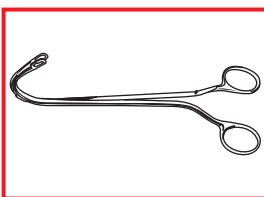

Scale I  
Charriere (French) No. 8-36  
rising by 1/3 mm per number  
Scale II  
Benique No. 20-26, rising  
by 1/3 mm per two numbers



**Dittel**  
6-10 mm  
18-30 Charriere



**Dittel**  
Charriere (French)  
No. 8-30  
34.5 cm / 13 3/4"



**Van Buren**  
Charriere (French)  
No. 8-36  
28 cm / 11"



**Guyon**  
Charriere  
No. 10-30  
27 cm / 10 1/2"



**Guyon**  
Charriere  
No. 10-30  
27 cm / 10 1/2"

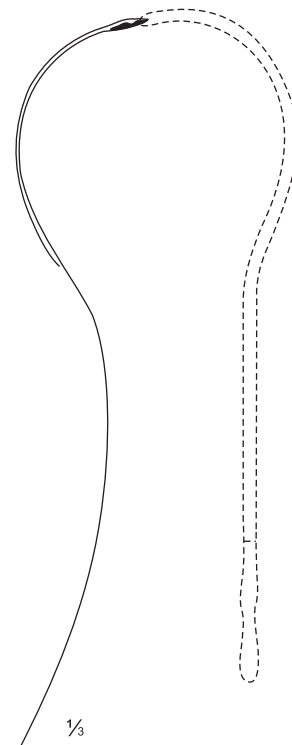

**Filiform**  
with screw  
Thread Guides  
33 cm / 13"

Set	32-209-00		32-209-08 - 32-209-30	32-211-00	32-211-08 - 32-211-36	32-213-00	32-213-10 - 32-213-30	32-215-00	32-215-10 - 32-215-30
single	32-207-00								
Scale	I	II	Dittel	Van Buren	Guyon	Guyon	Guyon	Guyon	Guyon
mm ø	Charriere (French)	Benique	str	curved	without int. thread	with int. thread	with int. thread	with int. thread	with int. thread
2	8		32-209-08	32-211-08					
3	9		32-209-09						
3	10	20	32-209-10	32-211-10	32-213-10		32-215-10		
3	11	22	32-209-11		32-213-11		32-215-11		
4	12	24	32-209-12	32-211-12	32-213-12		32-215-12		
4 1/3	13	26	32-209-13		32-213-13		32-215-13		
4 1/3	14	28	32-209-14	32-211-14	32-213-14		32-215-14		
5	15	30	32-209-15		32-213-15		32-215-15		
5 1/3	16	32	32-209-16	32-211-16	32-213-16		32-215-16		
5 1/3	17	34	32-209-17		32-213-17		32-215-17		
6	18	36	32-209-18	32-211-18	32-213-18		32-215-18		
6 1/3	19	38	32-209-19		32-213-19		32-215-19		
6 1/3	20	40	32-209-20	32-211-20	32-213-20		32-215-20		
7	21	42	32-209-21		32-213-21		32-215-21		
7 1/3	22	44	32-209-22	32-211-22	32-213-22		32-215-22		
7 1/3	23	46	32-209-23		32-213-23		32-215-23		
8	24	48	32-209-24	32-211-24	32-213-24		32-215-24		
8 1/3	25	50	32-209-25		32-213-25		32-215-25		
8 1/3	26	52	32-209-26	32-211-26	32-213-26		32-215-26		
9	27	54	32-209-27		32-213-27		32-215-27		
9 1/3	28	56	32-209-28	32-211-28	32-213-28		32-215-28		
9 1/3	29	58	32-209-29		32-213-29		32-215-29		
10	30	60	32-209-30	32-211-30	32-213-30		32-215-30		
10	32			32-211-32					
11	34			32-211-34					
12	36			32-211-36					

**Filiform Bougie, Urethral Sounds**

Gleitsonde, Harnröhrenbougies  
Sonda filiforme, Bujias uretrales

Bougie conductrice, Bougies urétrales  
Candeletta filiforme, Candelette dilatatrice



**Guyon**  
32-220-00  
420 x 175 x 40 mm

32-220-00 Set in metal case, containing  
21 Bougies Guyon 32-215-10 - 32-215-30



**Turner Warwick**  
32-222-18  
18 cm / 7"



**Hey-Groves**  
32-225-01 = 4/7EG  
32-225-02 = 6/8EG  
32-225-03 = 8/11EG  
17 cm / 6¾"



### Urethral Sounds

Harnröhrenbougies  
Bujías uretrales

Bougies urétrales  
Candelette dilatatrici



#### Clutton

26.7 cm / 10½"  
ø mm

FG/Charr.	ø mm	
6-10	2 - 3.3	32-242-01
8-12	2.7 - 4	32-242-02
10-14	3.3 - 4.7	32-242-03
12-16	4 - 5.3	32-242-04
14-18	4.7 - 6	32-242-05
16-20	5.3 - 6.7	32-242-06
18-22	6 - 7.3	32-242-07
20-24	6.7 - 8	32-242-08
22-26	7.3 - 8.7	32-242-09
24-26	8 - 9.3	32-242-10
26-30	8.7 - 10	32-242-11
28-32	9.3 - 10.7	32-242-12
set of 12		32-242-00



#### Lister

EG	ø mm	28 cm / 11"
00-1	0.5 - 1.5	32-245-01
0-2	1.0 - 2	32-245-02
½-3	1.3 - 2.5	32-245-03
1-4	1.5 - 3	32-245-04
2-5	2 - 3.5	32-245-05
3-6	2.5 - 4	32-245-06
4-7	3 - 4.5	32-245-07
5-8	3.5 - 5	32-245-08
6-9	4 - 5.5	32-245-09
7-10	4.5 - 6	32-245-10
8-11	5 - 6.5	32-245-11
9-12	5.5 - 7	32-245-12
10-13	6 - 7.5	32-245-13
11-14	6.5 - 8.0	32-245-14
12-15	7.0 - 8.5	32-245-15
13-16	7.5 - 9.0	32-245-16
14-17	8.0 - 9.5	32-245-17
15-18	8.5 - 10.0	32-245-18



#### Female Bladder Sound

EG	ø mm	26.7 cm / 10½"
6	4	32-248-01
8	5	32-248-02
10	6	32-248-03
12	7	32-248-04

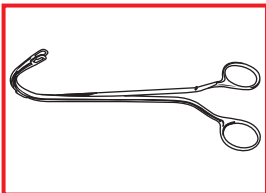

**Metal Catheters**

Metall-Katheter  
Sondas metálicas

Sondes métalliques  
Sonde metalliche



1/2



1/2



1/2

Table of measurements

32-255-06 - 32-255-24  
Charriere (French) No. 6-24  
27 cm / 10 1/2"  
Male Catheters

32-257-06 - 32-257-24  
Charriere (French) No. 6-24  
15 cm / 6"  
Female Catheters

Coxeter

Scale mm ø	Charriere (French)	32-255-06 - 32-255-24 Charriere (French) No. 6-24 27 cm / 10 1/2" Male Catheters	32-257-06 - 32-257-24 Charriere (French) No. 6-24 15 cm / 6" Female Catheters	
2	6	32-255-06	32-257-06	
2 1/3	7	32-255-07	32-257-07	
2 2/3	8	32-255-08	32-257-08	32-259-08
3	9	32-255-09	32-257-09	
3 1/3	10	32-255-10	32-257-10	32-259-10
4	12	32-255-12	32-257-12	32-259-12
4 1/3	13	32-255-13	32-257-13	
4 2/3	14	32-255-14	32-257-14	32-259-14
5	15	32-255-15	32-257-15	
5 1/3	16	32-255-16	32-257-16	32-259-16
5 2/3	17	32-255-17	32-257-17	
6	18	32-255-18	32-257-18	32-259-18
6 1/3	19	32-255-19	32-257-19	
6 2/3	20	32-255-20	32-257-20	32-259-20
7	21	32-255-21	32-257-21	
7 1/3	22	32-255-22	32-257-22	32-259-22
7 2/3	23	32-255-23	32-257-23	
8	24	32-255-24	32-257-24	32-259-24



## Urethrography- and Circumcision Instruments

Urethrographie- und Circumcisions-Instrumente  
Instrumentos para uretrografía y circuncisión

Instruments pour uréthrographie et circoncision  
Strumenti per uretrografia e circuncisione



32-261-08 - 32-261-32

- Circumcision Instrument
- 32-261-08 - 8 mm ø, baby size
- 32-261-11 - 11 mm ø, child size
- 32-261-13 - 13 mm ø, child size
- 32-261-16 - 16 mm ø, adolescent size
- 32-261-21 - 21 mm ø, adolescent size
- 32-261-26 - 26 mm ø, men's size
- 32-261-32 - 32 mm ø, men's size

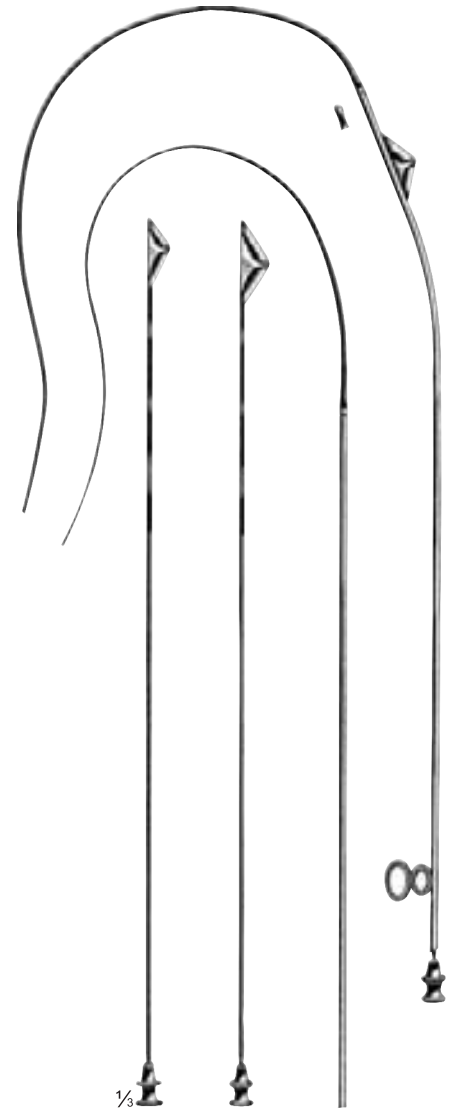

Maisonneuve  
32-267-00 - 32-269-00

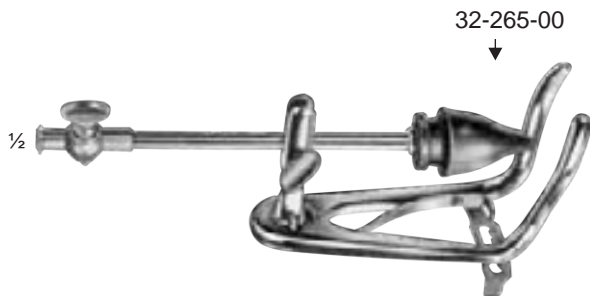

32-264-00  
18 cm / 7"

- 32-264-00 - Knutson Urethrography Instrument,  
- consisting of holder, penile, adjustable,  
with sliding cannula with  
rubber cone

- 32-267-00 - Urethrotome, Complete with 2 filiform  
guides, 1 stilette and 3 outward cutting  
blades
- 32-268-00 - ditto, but with 3 inward cutting blades
- 32-269-00 - wood Case for  
32-267-00 - 32-268-00



### Catheter Guides

Kathetereinführinstrumente  
Mandriles para catéteres

Mandrins pour sondes urétrales  
Mandrini per sonde uretrali

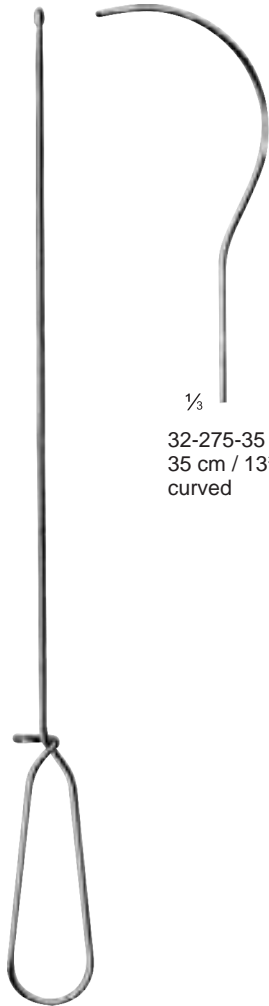

$\frac{1}{3}$   
32-275-35  
35 cm / 13 $\frac{3}{4}$ "  
curved

$\frac{1}{3}$

Guyon  
32-274-39  
39 cm / 15 $\frac{1}{2}$ "  
straight



$\frac{1}{3}$

32-277-46  
46 cm / 18"



$\frac{1}{3}$

32-279-46  
46 cm / 18"



**Foreign Body Forceps, Meatotome**

Fremdkörperzangen, Meatotom  
Pinzas para cuerpos extraños, Meatótomo

Pinces pour corps étrangers, Méatotome  
Pinze per corpi estranei, Meatotomo

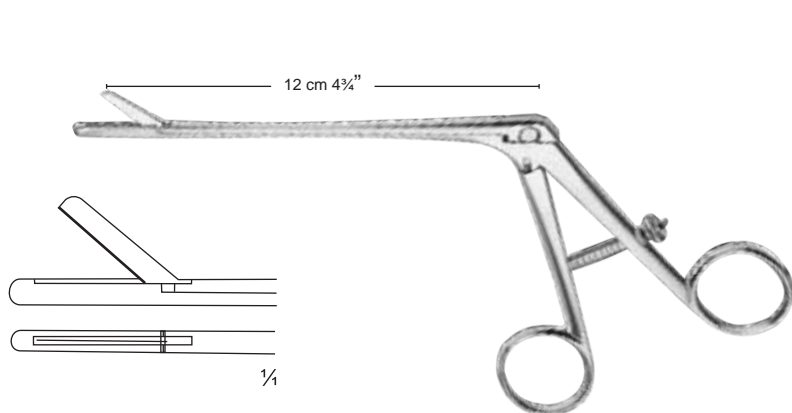
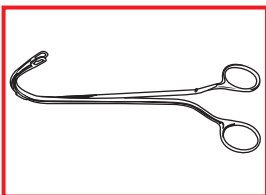

**Sachse**  
32-285-12

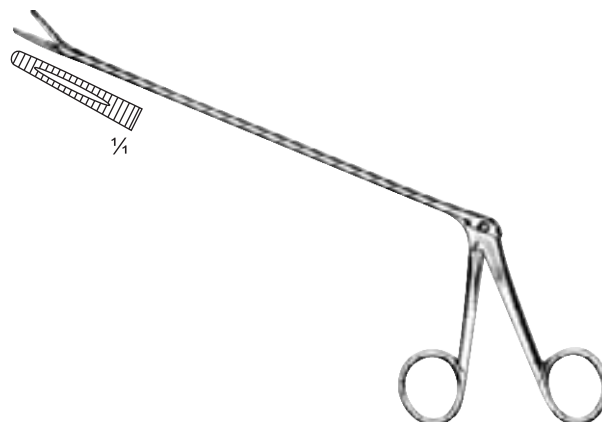

**Mathieu**  
32-287-20 = 20 cm / 8"  
32-287-28 = 28 cm / 11"  
Length of shaft



**Guttman**  
32-290-26  
26.5 cm / 10 1/2"

Penis Clamp, Penisklemme, Clamp para Pene, Pince pour Penis, Serrapene



**Thomson-Walker**  
32-292-11  
11 cm / 4 1/2"



**Stockmann**  
32-293-08  
8 cm / 3"

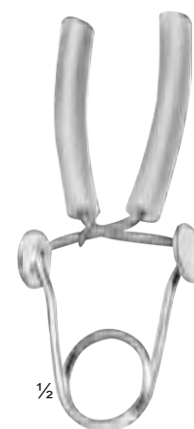

**Strauss**  
32-297-11  
11 cm / 4 1/2"



**Rectal Scissors**

Rektumschere  
Tijera para recto

Ciseaux pour rectum  
Forbici per il retto

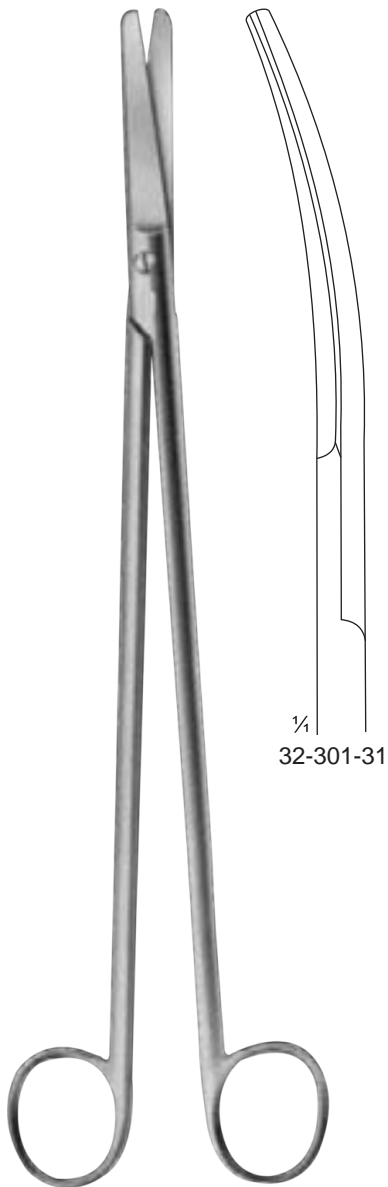

**Stelzner**  
32-300-31  
31 cm / 12<sup>3</sup>/<sub>8</sub>"

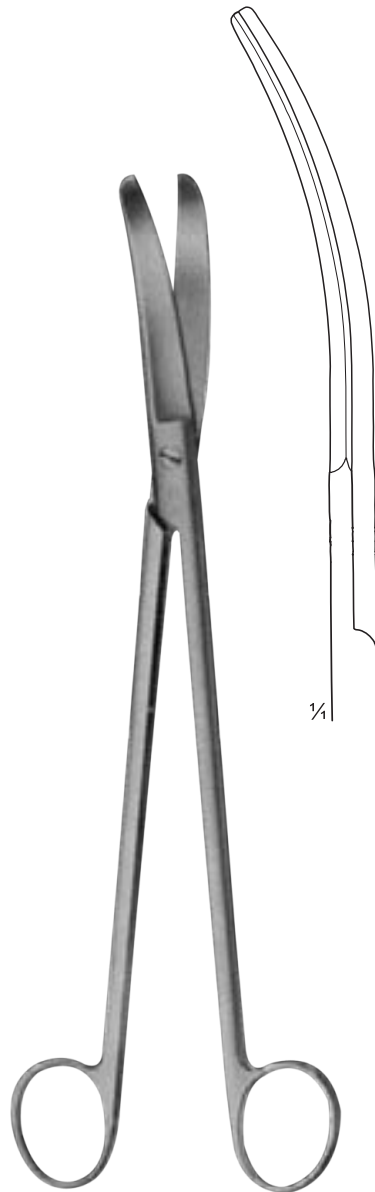

**Lloyd-Davies (Goligher's)**  
32-303-25  
25.5 cm / 10"

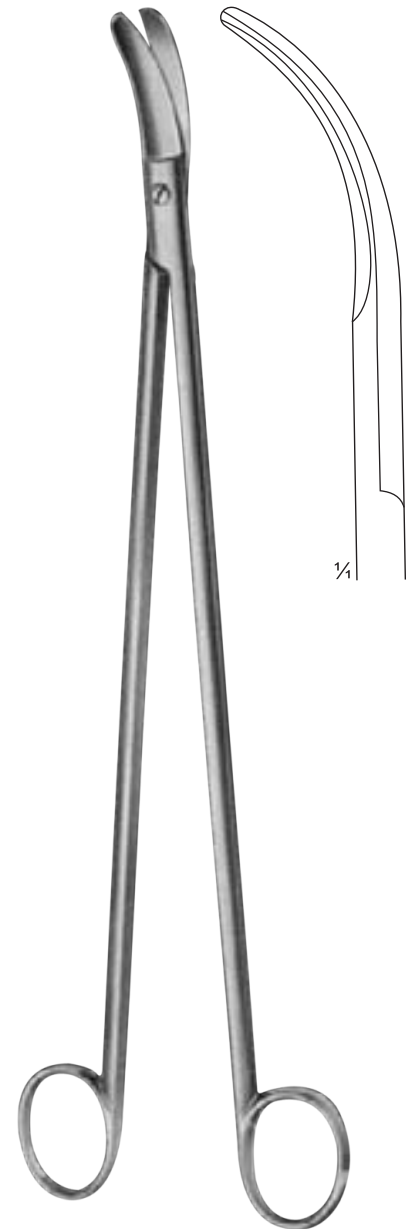

32-305-32  
32.5 cm / 13"



**Rectal Scissors**

Rektumschere  
Tijera para recto

Ciseaux pour rectum  
Forbici per il retto

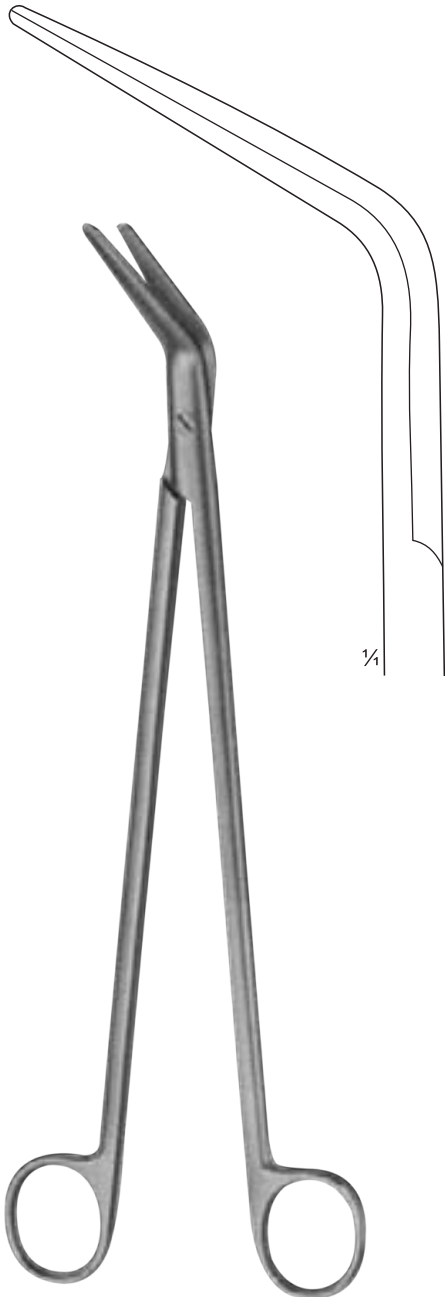

32-312-28  
28 cm / 11"

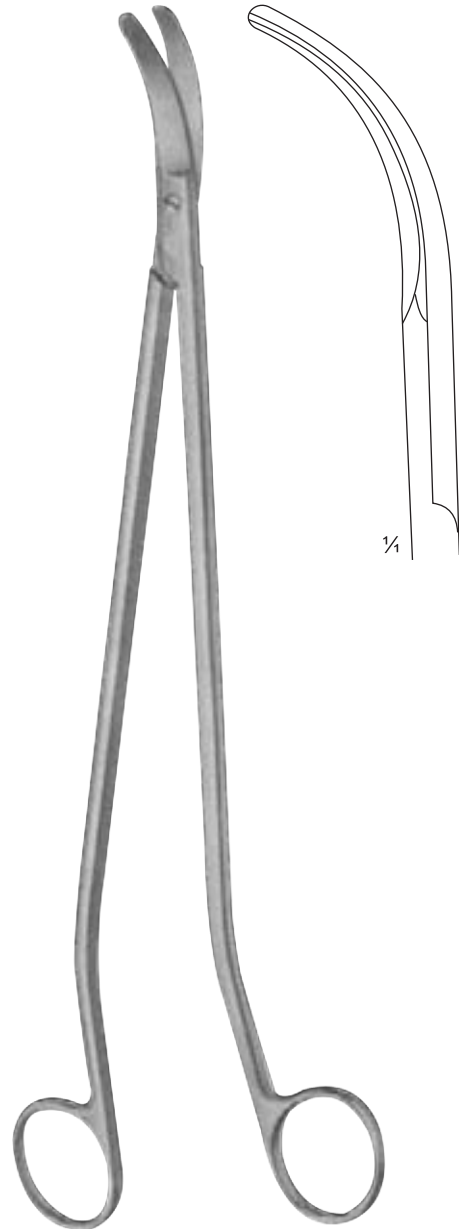

Müller  
32-315-32  
32.5 cm / 13"

**Sigmoid Anastomosis Forceps**

Rektum-Anastomosenklemmen  
Pinzas para anastomosis rectales

Pinces pour anastomoses rectales  
Pinze per anastomosi retтали

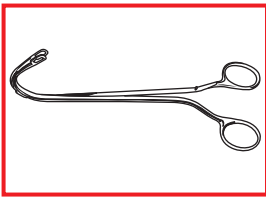

**ATRAUMA**

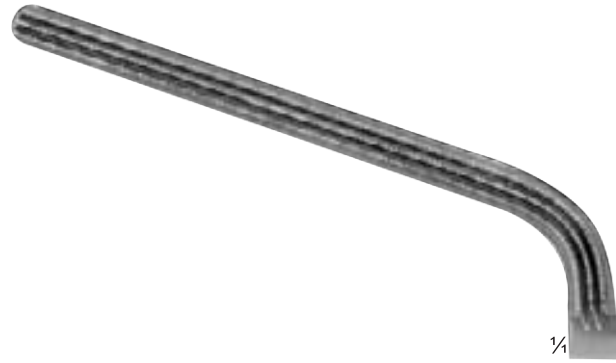

¼



¼



¼



**Morris**  
32-321-17  
17.5 cm / 7"

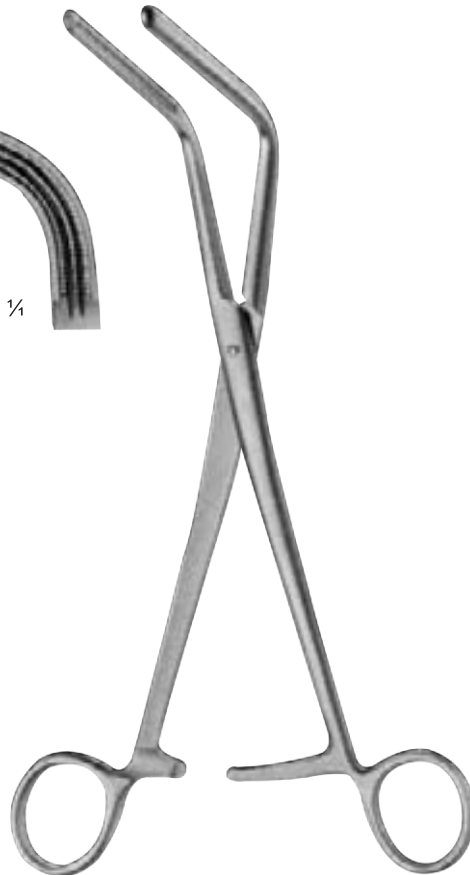

**Finch**  
32-323-23  
23 cm / 9"



**De Bakey**  
32-326-24  
24 cm / 9½"

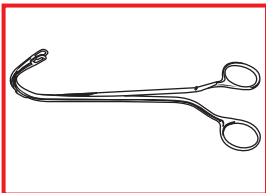

**Retractors**

Wundhaken  
Separadores

Ecarteurs  
Divaricatori

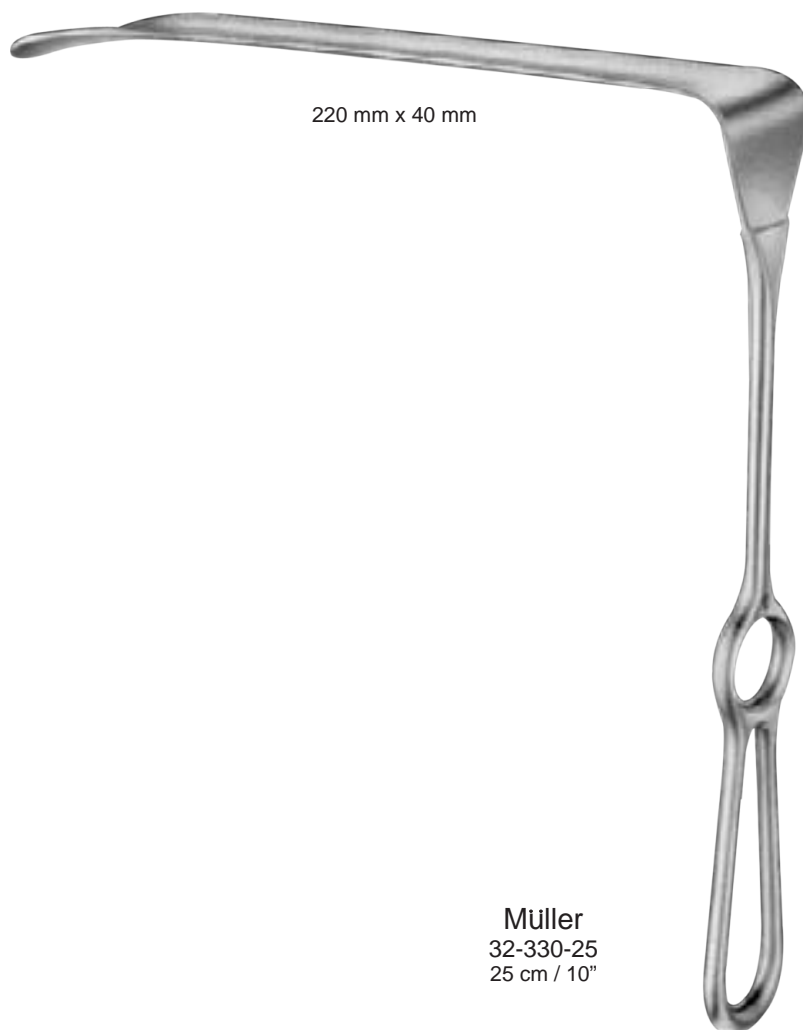
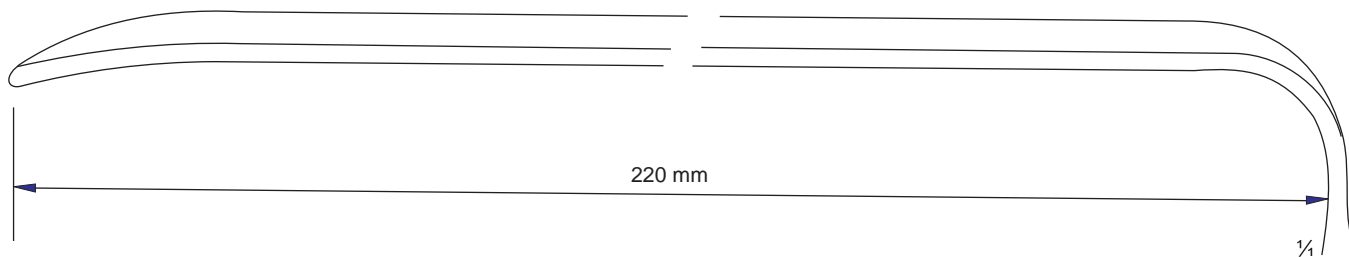

220 mm x 40 mm

Müller  
32-330-25  
25 cm / 10"

**Urethrography Instruments**

Urethrographie Instruments  
 Instruments pour urétrographie

Instrumentos para uretrografía  
 Strumenti per uretrografia



1/4  
 32-335-24

**Lewkowitz**  
 32-334-24 - 32-335-24  
 24.5 mm / 9 3/4"

1/2



1/2

**Young**  
 32-337-20  
 20.5 cm / 8"

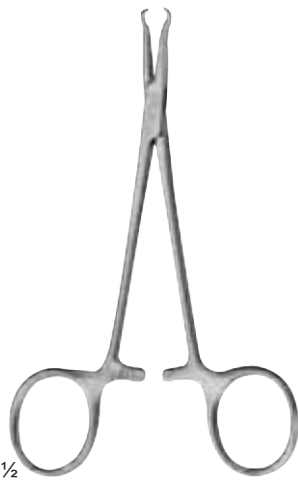

1/2

32-339-12  
 diam. 4.8 mm  
 12.5 cm / 5"



1/2

32-341-14  
 14.5 cm / 5 3/4"



1/2

32-344-16  
 16 cm / 6 1/4"