



# 13

## PUNCTURE/SPECIAL NEEDLES

PUNKTION/KANÜLEN  
PUNCION/AGUJAS ESPECIALES  
PONCTION/AIGUILLES SPECIALES  
PUNTURA/AGHI SPECIALI





**Trocars**

Trokare                      Trocarts  
Trócares                      Tre quarti



1/2

**Standard**

11.5 cm / 4 1/2"  
13-002-11 = 3 mm ø  
13-004-11 = 4 mm ø  
13-006-11 = 5 mm ø  
13-008-11 = 6 mm ø



1/2

**Standard**

12 cm / 4 3/4"  
13-010-12 = 3 mm ø  
13-012-12 = 4 mm ø  
13-014-12 = 5 mm ø  
13-016-12 = 6 mm ø



1/2

**Standard**

12 cm / 4 3/4"  
13-018-12 = 3 mm ø  
13-020-12 = 4 mm ø  
13-022-12 = 5 mm ø  
13-024-12 = 6 mm ø



1/2

**Universal**

13-026-03                      13-028-04  
Set of 3 Pieces              Set of 4 Pieces  
14 cm / 5 1/2"              14 cm / 5 1/2"

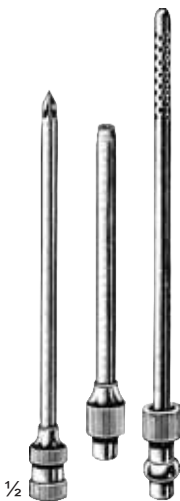

1/2

**Duke**

13-030-11  
11.5 cm / 4 1/2"  
5.5 mm ø



1/2



1/4

Fig 1  
13-032-07  
7.5 mm



Fig 2  
13-034-09  
9.5 mm



Fig 3  
13-036-11  
11 mm

**Nelson**

13-032-07 - 13-036-11  
20cm / 8"

**Trocars**

Trokare Trocarts  
Trócares Trequarti



1/2  
**Campbell**  
13-042-06 - 13-042-08  
16 cm / 6 1/4"

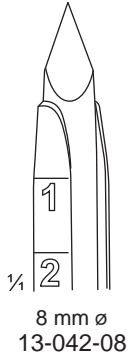
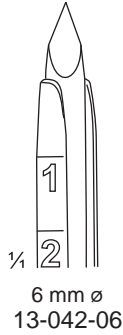

1/2  
**Buelau**  
13-044-24  
24 cm / 9 1/2"  
8 mm ø

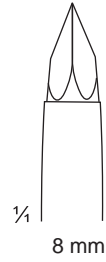

1/2  
**Fleurant**  
13-047-23  
23 cm / 9"  
5 mm ø



1/2  
**Fleurant**  
13-049-23  
23 cm / 9"  
5 mm ø



1/2  
**Ochsner**  
14cm/5 1/2"  
13-052-14 = 4 mm ø  
13-054-14 = 5.5 mm ø  
13-056-14 = 6.5 mm ø

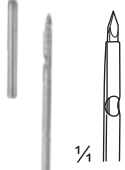

**Billroth**  
13-058-24  
24cm/9 1/2"  
6 mm ø

**Trocars**Trokare  
TrócaresTrocarts  
Trequarti

1/2

**Landau**13-064-16  
16 cm / 6 1/4"  
2 mm ø

1/2

**Lichtwitz**13-066-19  
18.5 cm / 7 1/4"  
1.8 mm ø

1/2

**Pierce**13-069-30 = 3 mm ø  
13-069-40 = 4 mm ø  
13-069-50 = 5 mm ø  
16 cm / 6 1/4"

Record Cone 1

Record  
Cone

1/2

**Krause**13-071-30 = ø 3 mm  
13-071-40 = ø 4 mm  
13-071-50 = ø 5 mm  
13-071-55 = ø 5.5 mm  
16 cm / 6 1/4"

1/2

**Coakley**13-073-14  
14 cm / 5 1/2" = 2.25 mm

Luer-Lock Cone

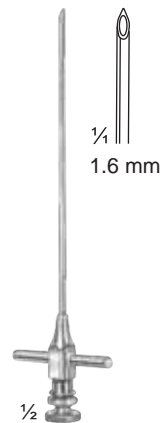

1/2

**Douglas**13-075-11  
3 mm ø

1/2

**Lichtwitz**13-078-11  
11.5 cm / 4 1/2"1/4  
1.6 mm

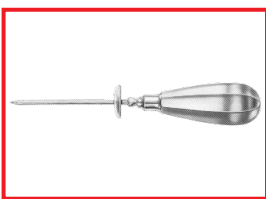

**Trocars**

Trokare      Trocarts  
Trócares      Tre quarti



**Sinuscopy**

L (mm)	ø 3.3 mm	ø 5.0 mm	ø 5.0 mm
75	13-082-01		
85		13-082-10	13-082-25
110		13-082-15	



**Brich**  
13-084-18  
18 cm / 7"  
4.5 mm ø



**Robert**  
13-086-02 2EG  
13-086-03 3EG  
13-086-04 4EG



**Vogel**  
13-089-26  
26 cm / 10 1/4"



**Tilley Harpoon**  
13-092-17  
17 cm / 6 3/4"

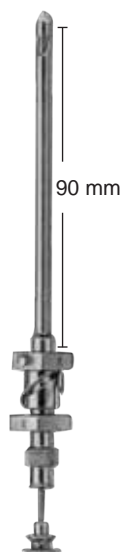

**Abrams**  
13-095-14  
14 cm / 5 1/2"  
ø 4 mm



**witts/Sahla**  
13-097-00  
(Sternal Puncture)



**Pean**  
13-099-16  
13.5 mm ø



**Kilma**  
13-106-07  
7 cm / 2 3/4"  
25 x 1.8 mm



**Guide Needles**

Führungsnadeln  
Agujas de guía

Aiguilles d' introduction  
Aghi per introduzione

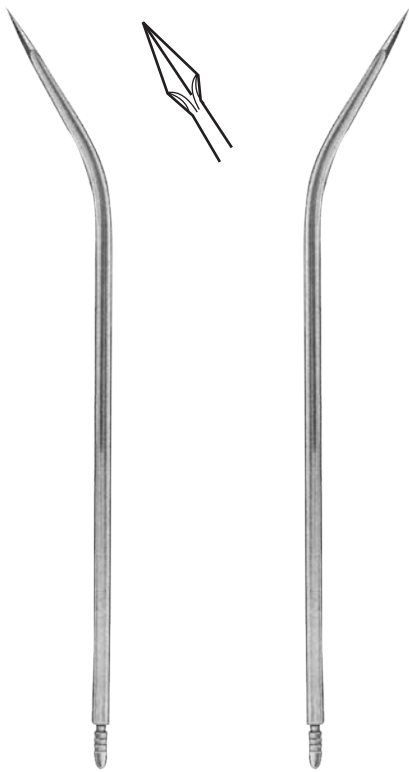

**Redon**  
19.5 cm / 7¾"

**Lancet Tip**  
slightly curved

**Redon**  
19.5 cm / 7¾"

**Trocar Tip**  
slightly curved

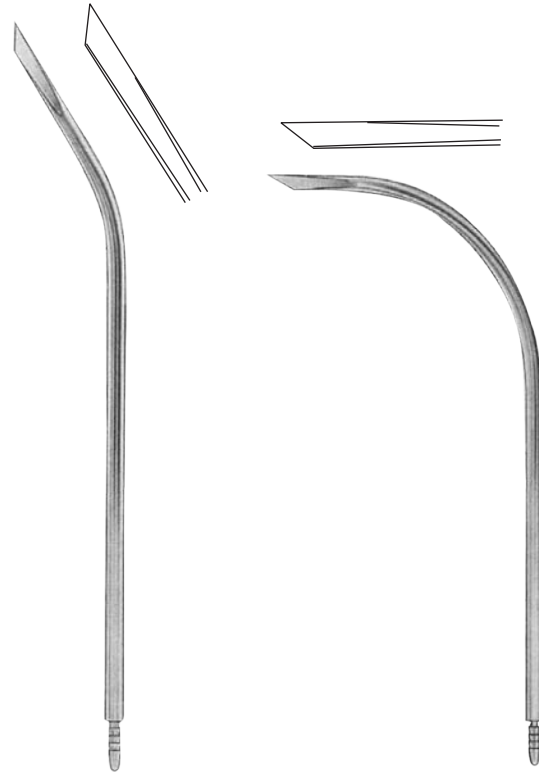

**Redon**  
19.5 cm / 7¾"

**Knife Tip**  
slightly curved

**Redon**  
19.5 cm / 7¾"

**Knife Tip**  
strongly curved

charr. /Fr.

8	13-112-08
10	13-112-10
12	13-112-12
14	13-112-14
16	13-112-16
18	13-112-18

13-115-08
13-115-10
13-115-12
13-115-14
13-115-16
13-115-18

13-118-08
13-118-10
13-118-12
13-118-14
13-118-16
13-118-18

13-121-08
13-121-10
13-121-12
13-121-14
13-121-16
13-121-18



**Suction Tubes**

Saugrohre  
Tubos de aspiración

Canules d'aspiration  
Cannule per aspirazione

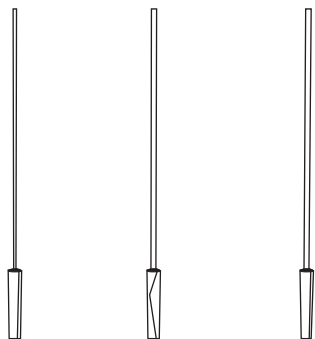

13-125-04  
ø 0.4 mm  
4.3 cm / 1 3/4"

13-125-06  
ø 0.6 mm  
4.3 cm / 1 3/4"

13-125-08  
ø 0.8 mm  
4.3 cm / 1 3/4"

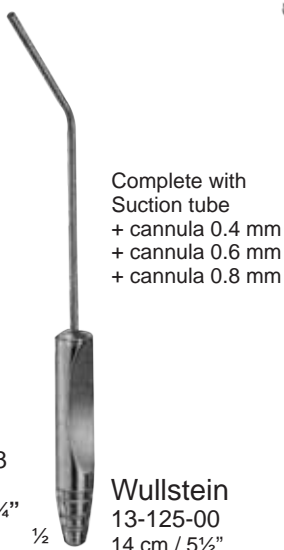

**Wullstein**  
13-125-00  
14 cm / 5 1/2"



**Plester**

1.5 mm 13-130-15  
2.0 mm 13-130-20  
2.5 mm 13-130-25  
3.0 mm 13-130-30  
19.5 cm / 7 3/4"

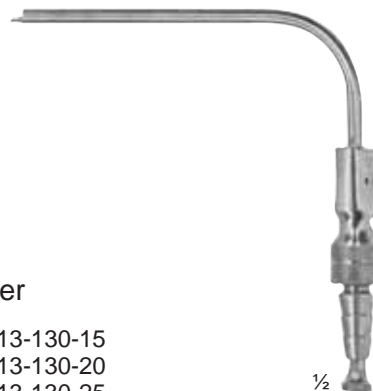

**Fergusson**

5 Charr. 13-132-05  
6 Charr. 13-132-06  
7 Charr. 13-132-07  
8 Charr. 13-132-08  
9 Charr. 13-132-09  
10 Charr. 13-132-10  
12 Charr. 13-132-12  
18 cm / 7"



**Adson**  
13-135-21  
4 mm ø  
21 cm / 8 1/4"



**Frazier**  
13-137-06 - 13-137-12  
19 cm / 7 1/2"

Charr./Fr.  
6 13-137-06  
8 13-137-08  
10 13-137-10  
12 13-137-12



**Frazier**  
13-139-58 - 13-139-60  
19 cm / 7 1/2"  
with fiber optic

Charr./Fr.  
6 13-139-58  
8 13-139-60



**Poppen**  
13-141-06 - 13-141-12  
18 cm / 7"

Charr./Fr.  
6 13-141-06  
8 13-141-08  
10 13-141-10  
12 13-141-12



**Poppen**  
13-143-58 - 13-143-60  
18 cm / 7"  
with fiber optic

Charr./Fr.  
6 13-143-58  
8 13-143-60





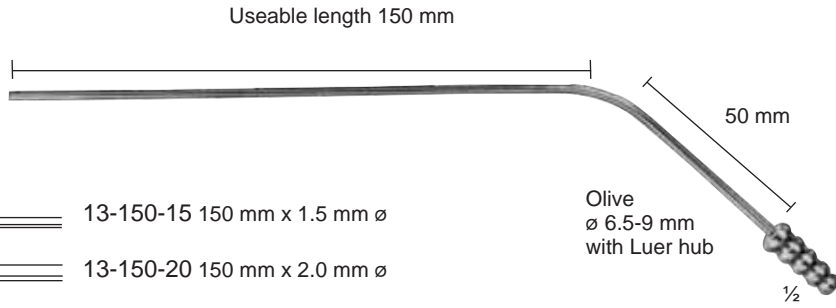

**Suction Tubes**

Saugrohre  
Tubos de aspiración

Canules d' aspiration  
Cannule per aspirazione



-  13-150-15 150 mm x 1.5 mm ø
-  13-150-20 150 mm x 2.0 mm ø
-  13-150-25 150 mm x 2.5 mm ø
-  13-150-35 150 mm x 3.5 mm ø

**Yasargil**  
13-150-15 - 13-150-35  
21.5 cm / 8½"

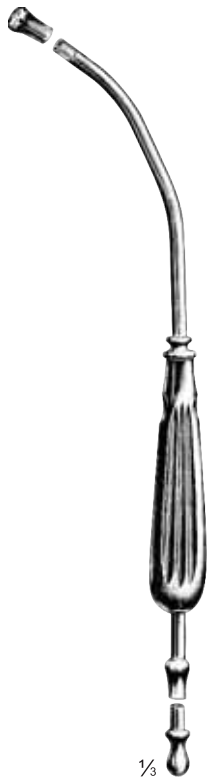

**Yankauer**  
13-153-31  
31 cm / 12¼"



Fig. 0  
13-155-10  
10 cm / 4"



1  
13-155-11  
10 cm / 4"



2  
13-155-12  
10 cm / 4"



3  
13-155-13  
13.5 cm / 5¼"

13-155-15



**Yankauer**  
13-155-00 - 13-155-15  
15 cm / 6"  
Fig. 0 - 3

13-155-01



13-155-02  
2.5 cm / 1"



**Suction Tubes**

Saugrohre  
Tubos de aspiración

Canules d' aspiration  
Cannule per aspirazione

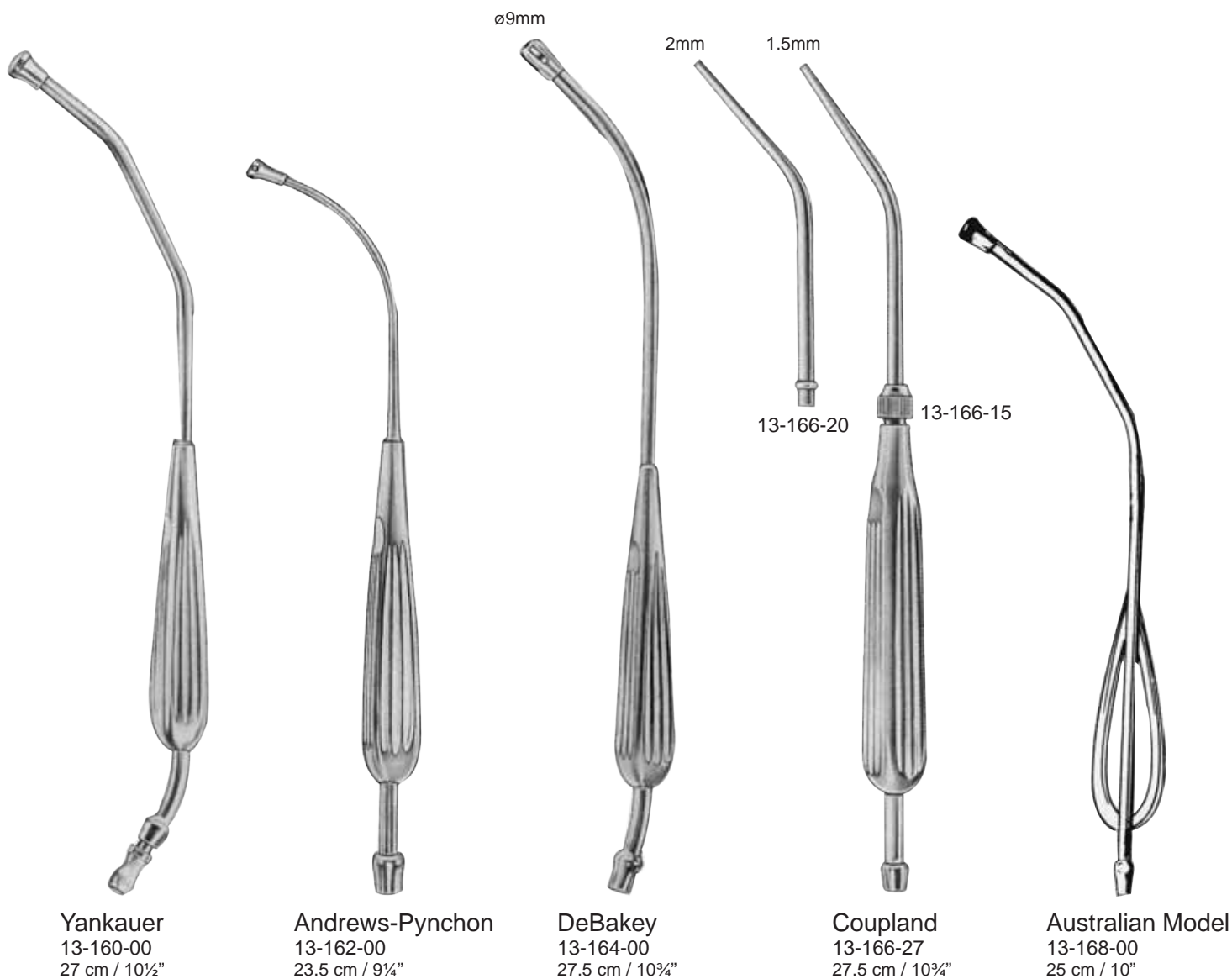

ø9mm

2mm

1.5mm

13-166-20

13-166-15

**Yankauer**  
13-160-00  
27 cm / 10½"

**Andrews-Pynchon**  
13-162-00  
23.5 cm / 9¼"

**DeBakey**  
13-164-00  
27.5 cm / 10¾"

**Coupland**  
13-166-27  
27.5 cm / 10¾"

**Australian Model**  
13-168-00  
25 cm / 10"

**Suction Tubes**

Saugrohre  
Tubos de aspiración

Canules d' aspiration  
Cannule per aspirazione



ø 8 mm



1/2

**Cooley**  
13-175-36  
36 cm / 14 1/4"

ø 10 mm



1/2

**Cooley**  
13-177-31  
31 cm / 12 1/4"

ø 7 mm



1/2

**Cooley**  
13-179-31  
31 cm / 12 1/4"

ø 8 mm



1/2

**Cooley**  
13-181-36  
36 cm / 14 1/4"



1/2

**Poole**  
13-184-22  
22 cm / 8 3/4"  
(Charr./Fr.30)  
10 mm ø



1/2

**Poole**  
13-187-22  
22 cm / 8 3/4"  
(Charr./Fr.23)  
8 mm ø



**Baby-Poole**  
13-189-20  
20 cm / 8"  
5.5 mm

**Suction Tubes**

Saugrohre  
Tubos de aspiración

Canules d' aspiration  
Cannule per aspirazione



∅ 3 mm



**Frazier/Lempert**  
13-195-30  
19.5 cm / 7¾"



**Magill**  
13-197-30 - 13-197-40  
24.5 cm / 9¾"

- ∅ 3 mm  
13-197-30
- ∅ 3.5 mm  
13-197-35
- ∅ 4 mm  
13-197-40

∅ 3 mm



**Gillies**  
13-199-30  
17 cm / 6¾"

∅ 4 mm



**Kilner**  
13-201-40  
19 cm / 7½"

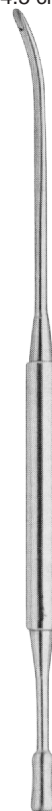

**Gorney**  
13-204-18  
18 cm / 7"



**Negus**  
13-207-21  
21 cm / 8¼"  
Suction Dissector

**Suction Tubes**

Saugrohre  
Tubos de aspiración

Canules d' aspiration  
Cannule per aspirazione

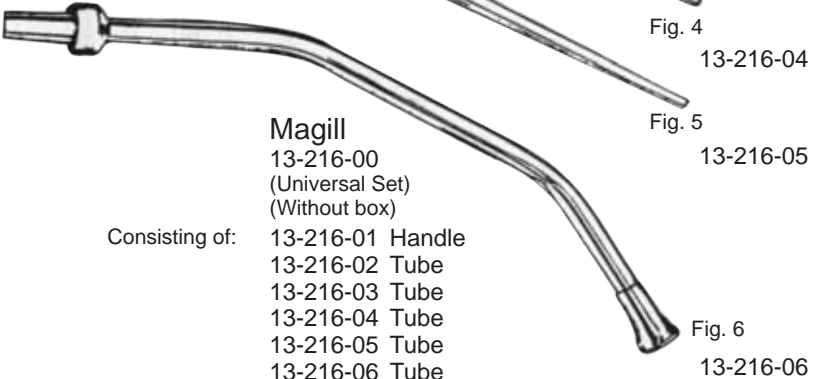
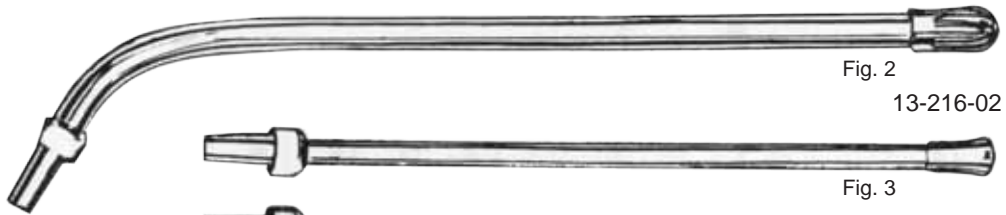

**Magill**

13-216-00  
(Universal Set)  
(Without box)

Consisting of:

- 13-216-01 Handle
- 13-216-02 Tube
- 13-216-03 Tube
- 13-216-04 Tube
- 13-216-05 Tube
- 13-216-06 Tube
- 13-216-10 in wooden Box

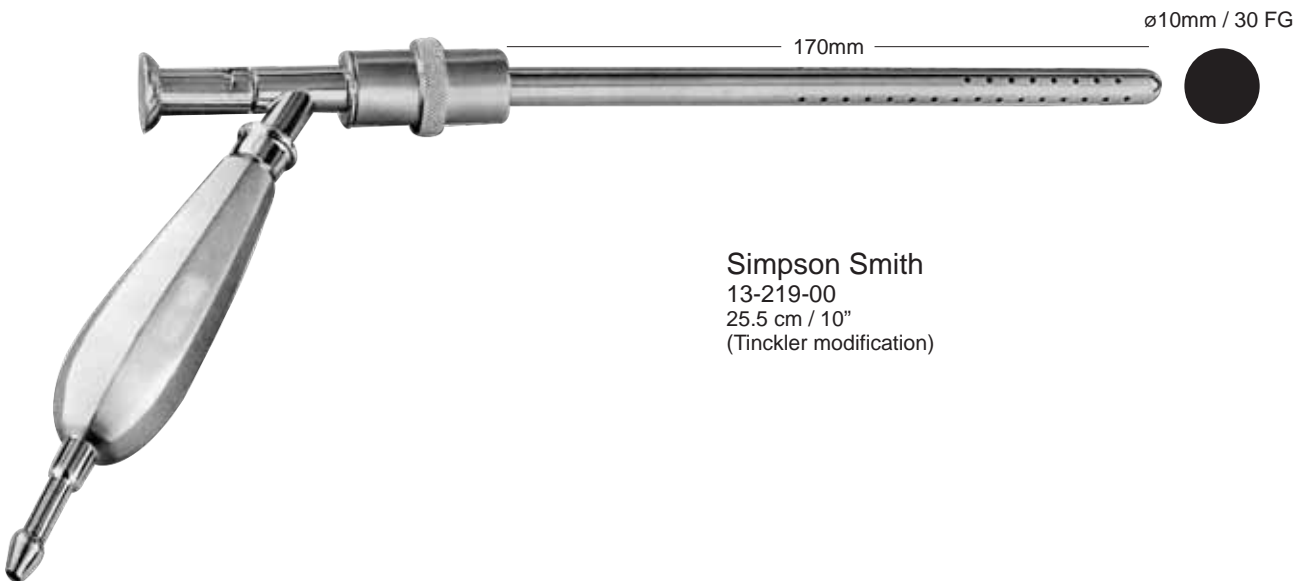

**Simpson Smith**

13-219-00  
25.5 cm / 10"  
(Tinckler modification)



**Suction Tubes**

Saugrohre  
Tubos de aspiración

Canules d' aspiration  
Cannule per aspirazione



1/2  
**Nuboer**  
13-225-21  
21 cm / 8 1/4"  
6 mm ø



1/2  
**Nuboer**  
13-227-21  
21 cm / 8 1/4"  
6 mm ø



1/2  
**Coupland**  
13-229-24  
17 cm / 6 3/4"



○ 13-229-01  
1.5 mm ø  
9.5 cm / 3 1/2"

○ 13-229-02  
2 mm ø  
9.5 cm / 3 1/2"

○ 13-229-03  
2.5 mm ø  
9.5 cm / 3 1/2"

1/4 ○ 13-229-04  
3.5 mm ø  
9.5 cm / 3 1/2"



○ 13-229-05  
1.5 mm ø  
9.5 cm / 3 1/2"

○ 13-229-06  
2 mm ø  
9.5 cm / 3 1/2"

○ 13-229-07  
2.5 mm ø  
9.5 cm / 3 1/2"

1/4 ○ 13-229-08  
3.5 mm ø  
9.5 cm / 3 1/2"

With Additional Side Holes



○ 13-231-01  
1.5 mm ø

○ 13-231-02  
2.5 mm ø

○ 13-231-03  
3.5 mm ø

1/2  
**Byrd**  
13-231-01 - 13-231-03  
21.5 cm / 8 1/2"

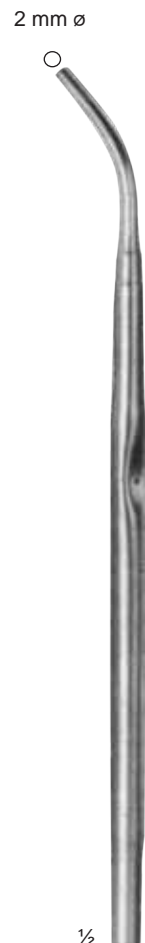

2 mm ø  
1/2  
**Cogswell**  
13-233-23  
24.5 cm / 9 3/4"