

Falcon[®]

Surgical
Instruments



39

RHINOLOGY

RHINOLOGIE
RINOLOGÍA
RHINOLOGIE
RINOLOGIA



Nasal Specula

Nasenspekula
Especulos nasales

Spéculums nasaux
Specoli nasali

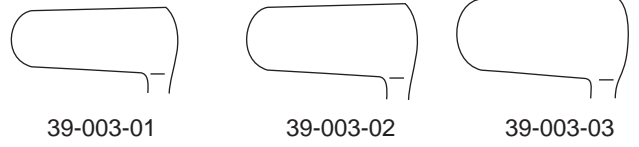
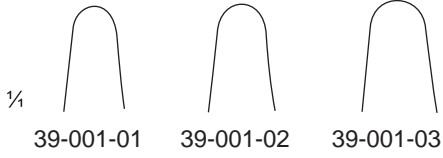
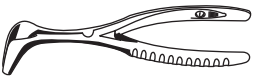

Voltolini
39-001-01 - 39-001-03



Goldsmith (Thudichum)
39-003-01 - 39-003-03
6.5 cm / 2½"

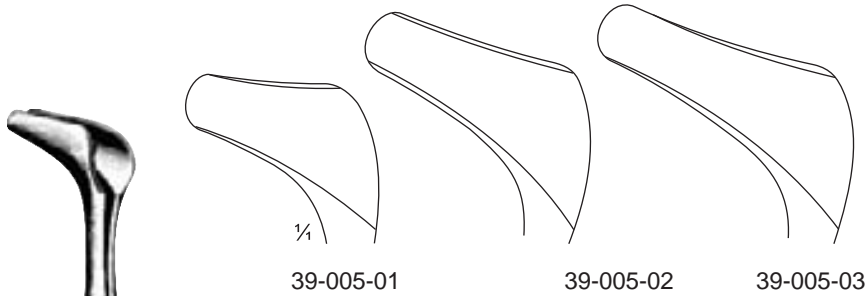

Hartmann-Halle
39-005-01 - 39-005-03
15 cm / 6"

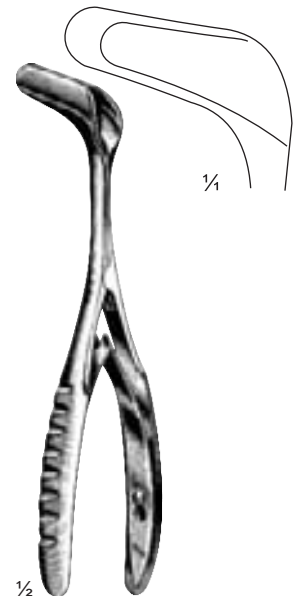

Schwarz
39-007-14
14 cm / 5½"

Nasal Specula

Nasenspekula
Espéculos nasales

Spéculums nasaux
Specoli nasali

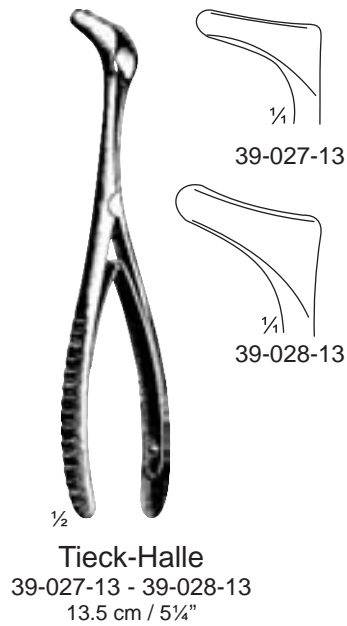
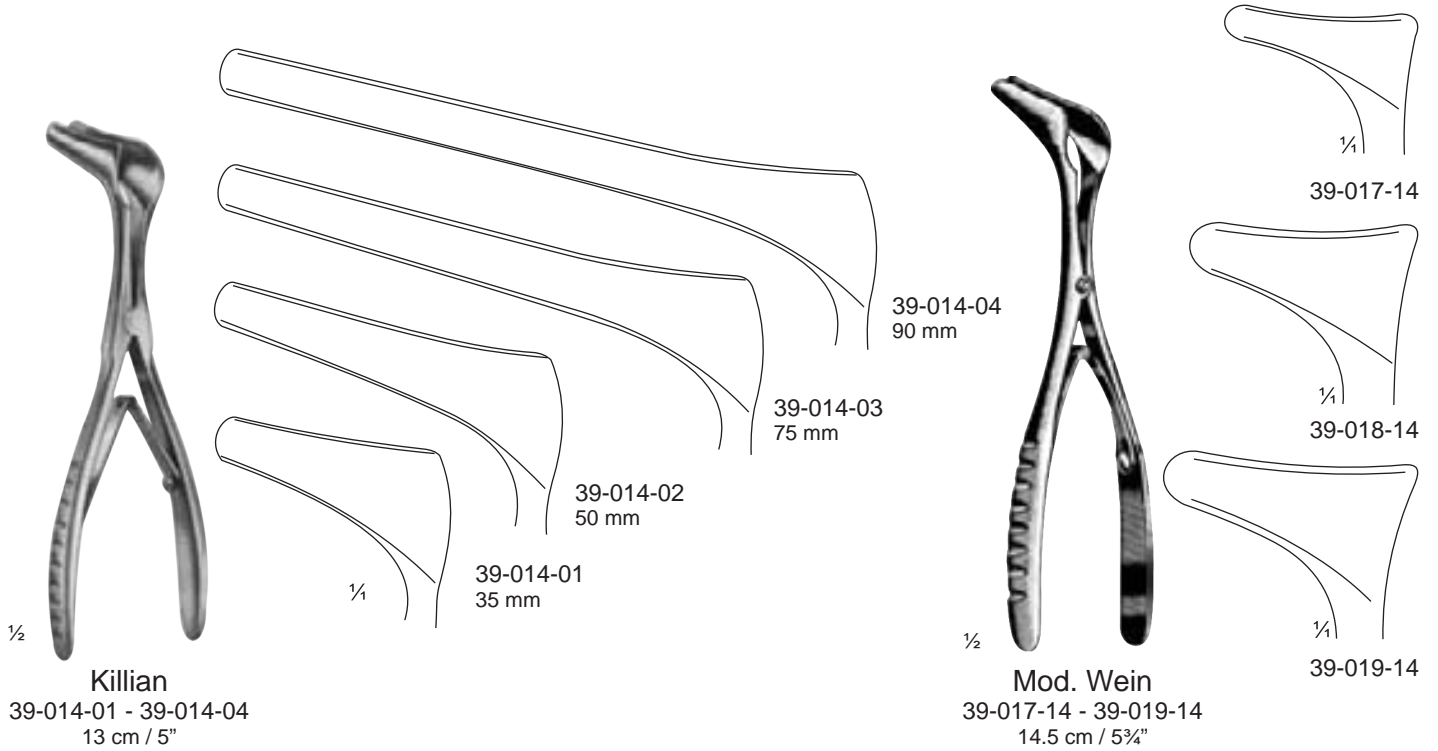
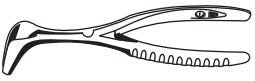

Nasal Specula

Nasenspekula
Espéculos nasales

Spéculums nasaux
Specoli nasali



1/2
Cottle
39-039-45 - 39-039-75
14 cm / 5 1/2"

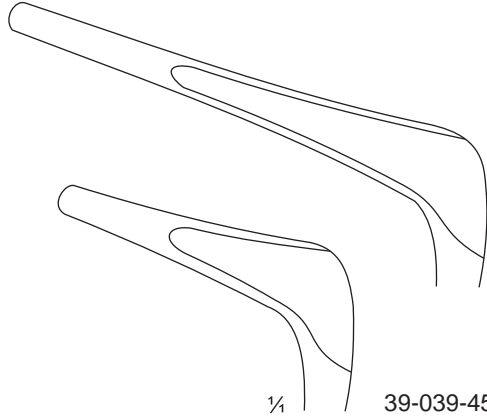

1/4
39-039-45
45 mm



1/2
Yankauer
39-042-19
19 cm / 7 1/2"

Dull black chromium plated



1/2
Cottle
39-045-35 - 39-045-90
15 cm / 6"

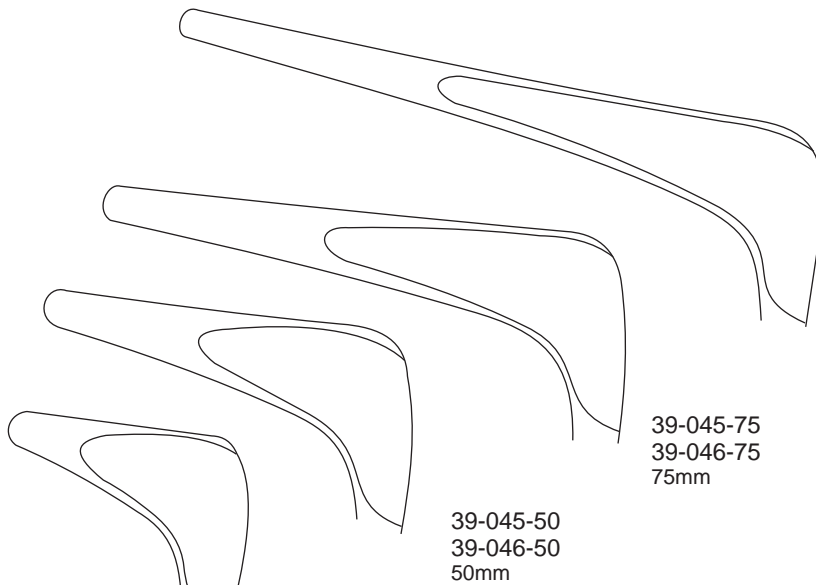

1/4
39-045-35
39-046-35
35mm

39-045-50
39-046-50
50mm

39-045-75
39-046-75
75mm

39-045-90
39-046-90
90mm

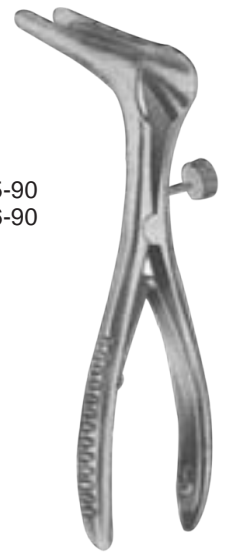

Cottle
39-046-35 - 39-046-90
15 cm / 6"

Nasal Specula

Nasenspekula
Espéculos nasales

Spéculums nasaux
Specoli nasali

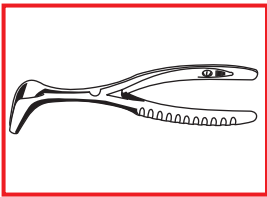

Hartmann
39-052-01 - 39-052-03
15 cm / 6"

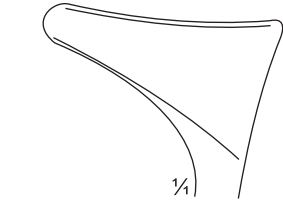

39-052-01

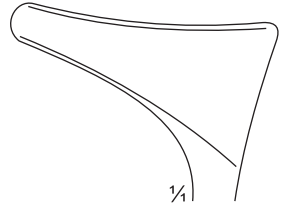

39-052-02

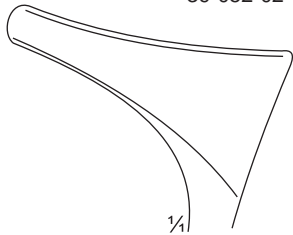

39-052-03



Beckmann
39-055-01 - 39-055-03
15 cm / 6"

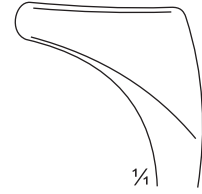

39-055-01

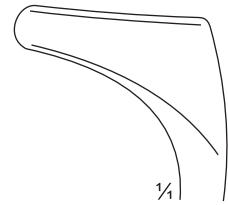

39-055-02

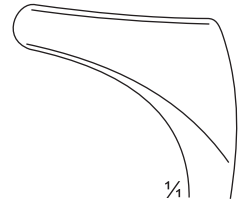

39-055-03



1

39-058-01
39-060-01



2

39-058-02
39-060-02



3

39-058-03
39-060-03

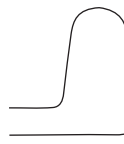

4

39-058-04
39-060-04



5

39-058-05
39-060-05



6

39-058-06
39-060-06

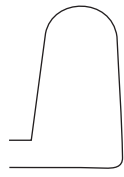

7

39-058-07
39-060-07

**Thudichum
(Mark-Hovell)**

- 39-058-00 Set of 7
 - 39-058-01 NO.1
 - 39-058-02 NO.2
 - 39-058-03 NO.3
 - 39-058-04 NO.4
 - 39-058-05 NO.5
 - 39-058-06 NO.6
 - 39-058-07 NO.7
- 7 cm / 2¾"

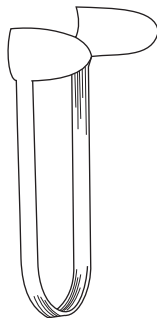

**Thudichum
(Mark-Hovell)
(INSULATED)**

- 39-060-00 Set of 7
 - 39-060-01 NO.1
 - 39-060-02 NO.2
 - 39-060-03 NO.3
 - 39-060-04 NO.4
 - 39-060-05 NO.5
 - 39-060-06 NO.6
 - 39-060-07 NO.7
- 7 cm / 2¾"



St.Clair Thomson

- 39-061-38 = 38mm
 - 39-061-50 = 50mm
 - 39-061-65 = 65mm
 - 39-061-75 = 75mm
- 7.5 cm / 2¾"

Polypus Snares

Polypenschnürer
Polipótomos

Serre-noeuds pour polypes
Serranodi per polipi

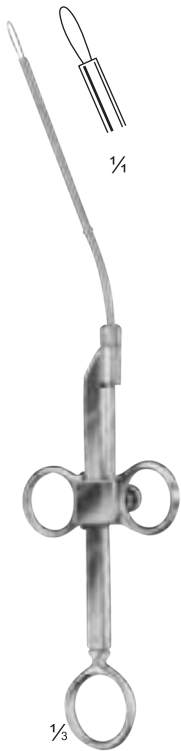
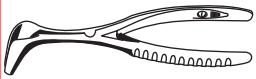

Krause
39-069-26
26 cm / 10¼"



Krause-Voss
39-071-26
26 cm / 10¼"

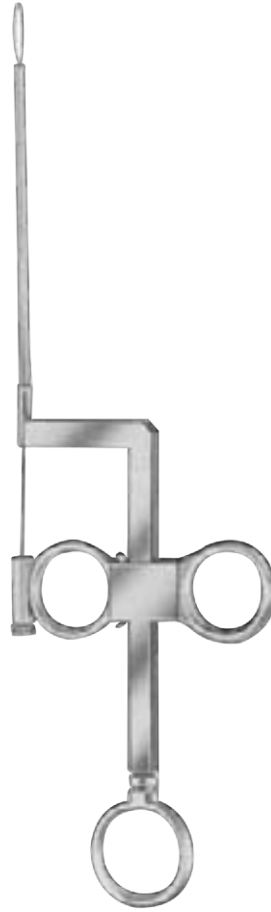

Lange-Wilde
39-074-24
24 cm / 9½"

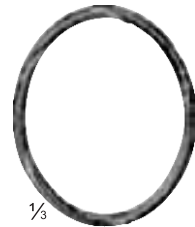

10 m/33 ft.
39-076-30 = 0.3 mm ø
39-076-40 = 0.4 mm ø



39-079-12
0.3 mm ø
Pack of 12 pcs.



Nasal Tampon Forceps, Nasal Polypus Forceps

Nasentamponpinzetten, Nasenpolypenzangen
 Pinzas para taponamiento, Pinzas para pólipos nasales

Pinces à pansements, Pinces à polypes nasaux
 Pinze per medicature, Pinze per polipi nasali,



Troeltsch (Wilde)
 39-085-15
 15 cm / 6"



Troeltsch (Wilde)
 39-087-18
 18 cm / 7"



Gruenwald (Jansen)
 39-089-20
 20 cm / 8"



Westmacott
 39-091-20
 20 cm / 8"

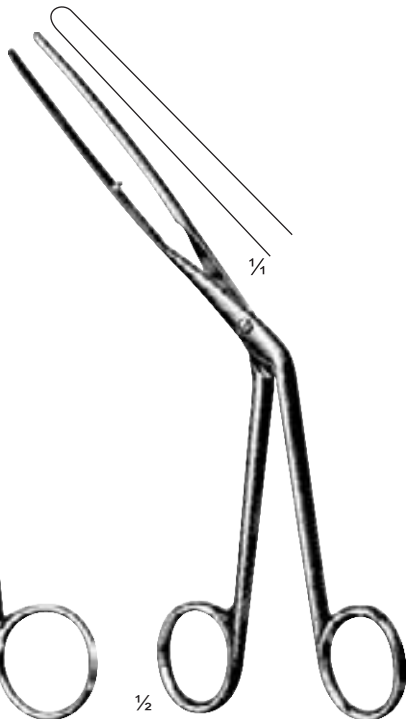

Lubet-Barbon
 39-093-20
 20 cm / 8"



Hartmann
 39-095-16
 16 cm / 6 1/4"

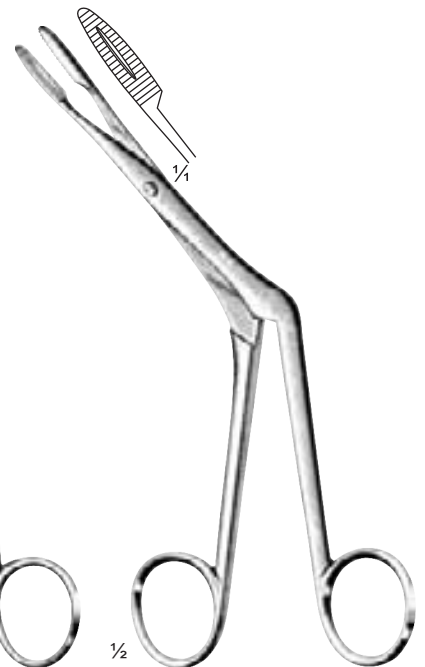

Hartmann-Knight
 39-097-18
 18 cm / 7"

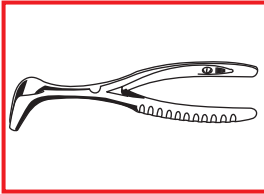

Nasal Polypus Forceps

Nasenpolypenzangen
Pinzas para pólipos nasales

Pinces à polypes nasaux
Pinze per polipi nasali,

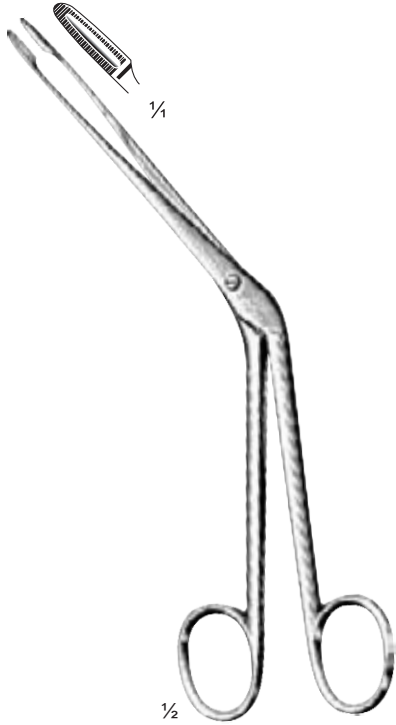

Hartmann
39-103-20
20 cm / 8"



Littauer
39-105-18
18 cm / 7"

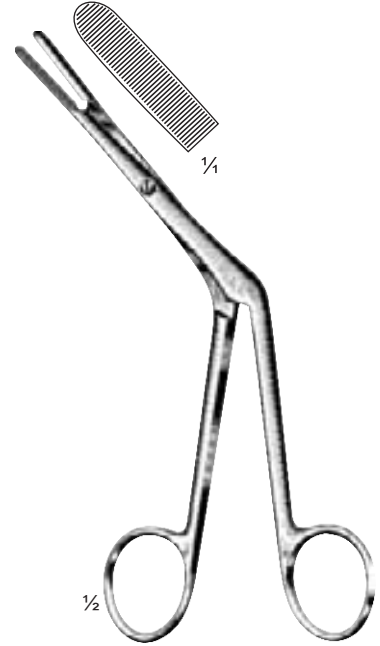

Killian
39-107-17
17 cm / 6 3/4"



Tilley
39-110-17
17 cm / 6 3/4"



Yankauer
39-113-17
17 cm / 6 3/4"

Septum Forceps, Ethmoid Bone Forceps

Septumzangen, Siebbeinzangen
Pinzas para tabique nasal, Pinzas para etmoides

Pinces pour la cloison nasale, Pincas éthmoidales
Pinze per il setto nasale, Pinze etmoidali

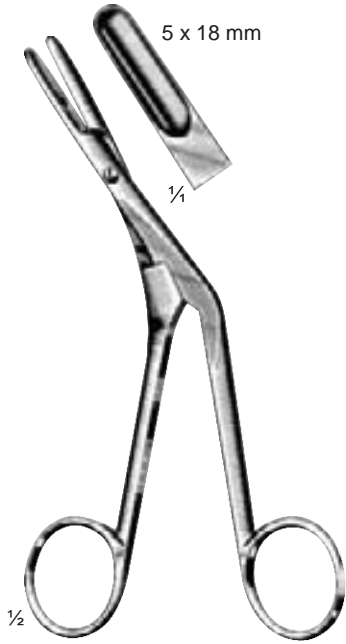

Craig
39-119-18
18 cm / 7"

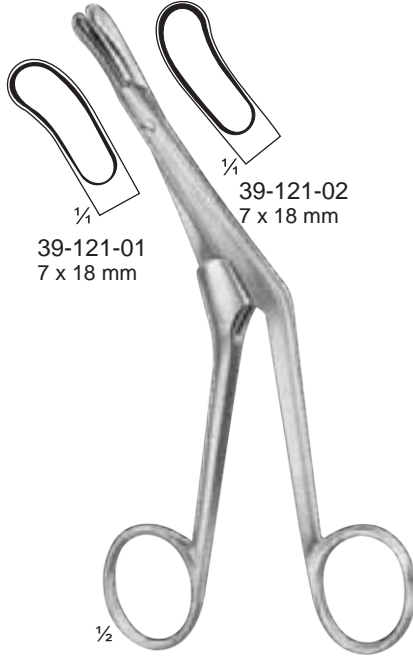

Craig-Domnick
39-121-01 - 39-121-02
18 cm / 7"

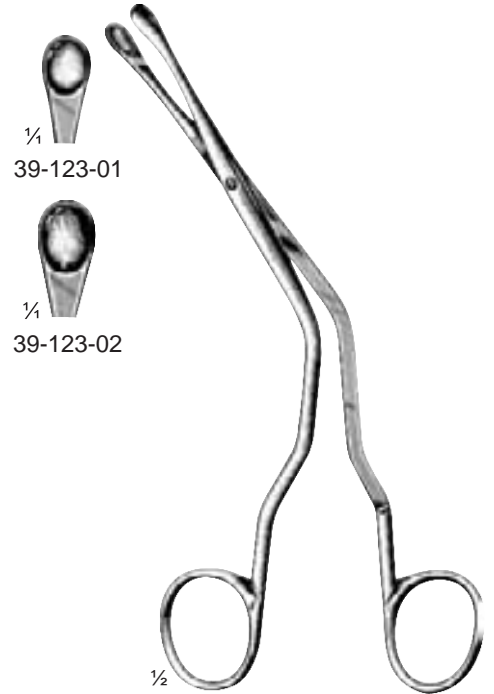

Luc
39-123-01 - 39-123-02
20 cm / 8"

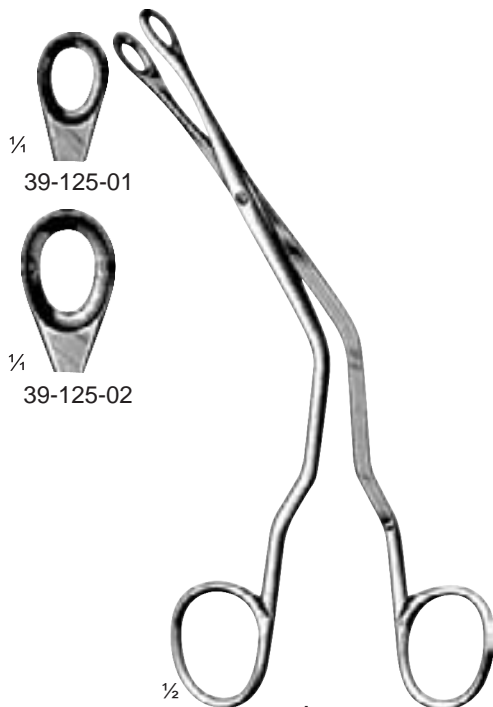

Luc
39-125-01 - 39-125-02
20 cm / 8"

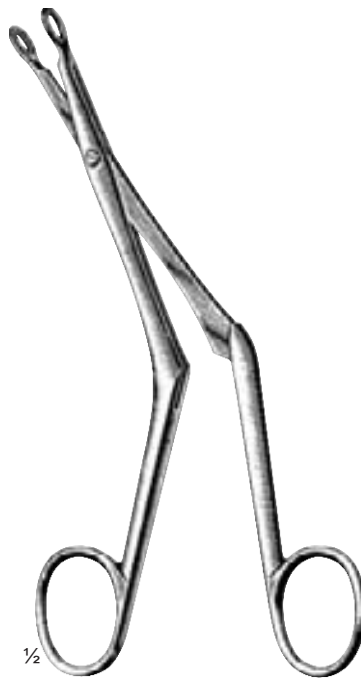

Bruenings
39-127-01 - 39-127-04
19 cm / 7 1/2"



Septum Forceps, Ethmoid Bone Forceps

Septumzangen, Siebbeinzangen
Pinzas para tabique nasal, Pinzas para etmoides

Pinces pour la cloison nasale, Pincas éthmoidales
Pinze per il setto nasale, Pinze etmoidali

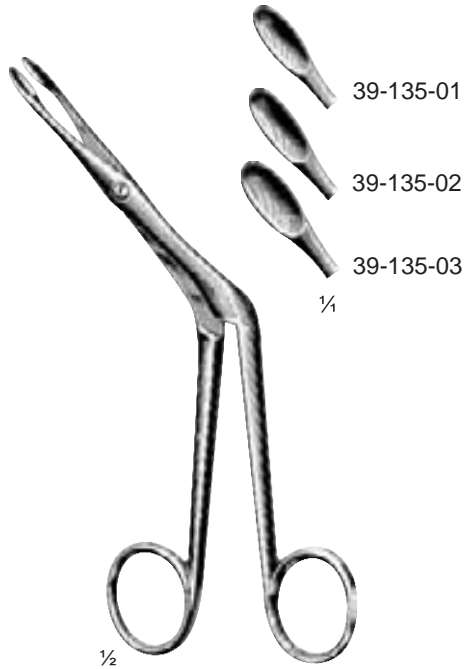

Heymann
39-135-01 - 39-135-03
18 cm / 7"

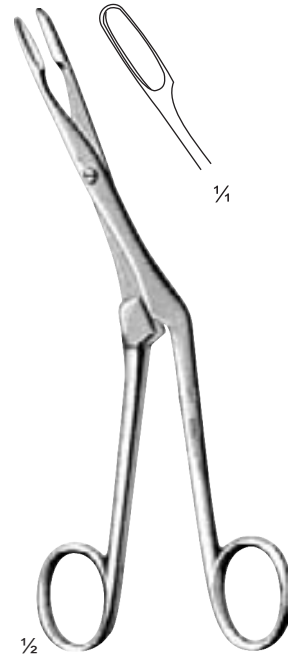

Knight
39-137-18
18 cm / 7"

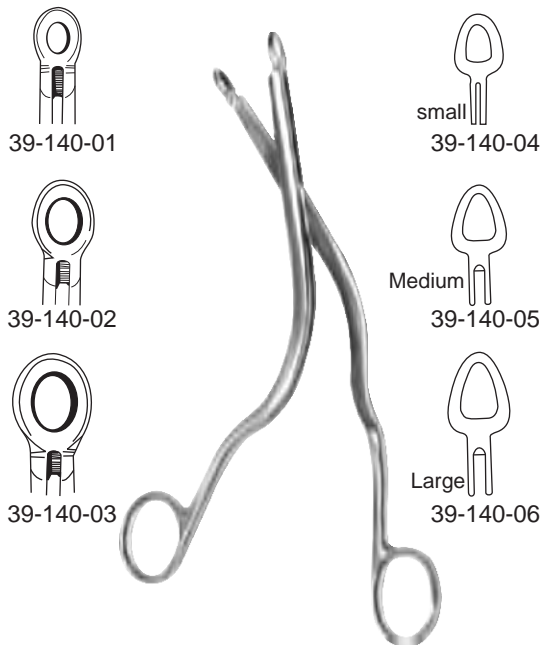

Luc
39-140-01 - 39-140-06
20 cm / 8"



Irwin-Moore
39-142-19
19 cm / 7½"

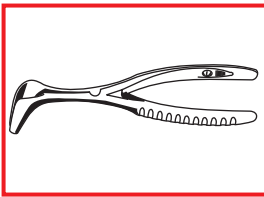

Nasal Cutting Forceps

Scharfe Nasenzangen
Pinzas nasales cortantes

Pinces nasales coupantes
Pinze taglienti per il naso

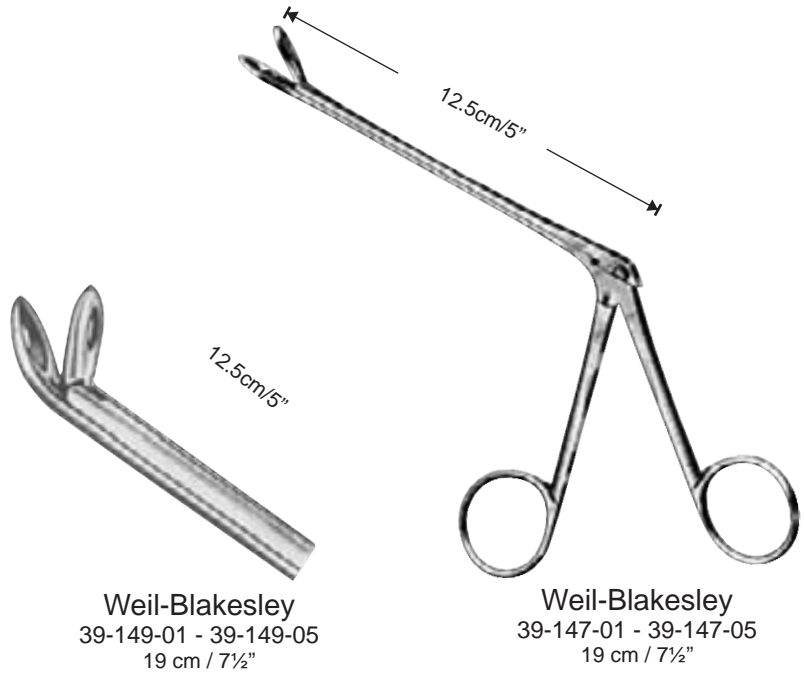

Watson-Williams
39-151-12
19 cm / 7½"



Watson-Williams
39-157-12
19 cm / 7½"

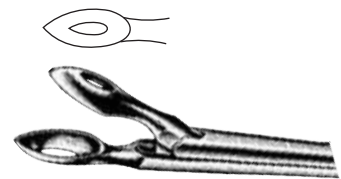

Weil
39-161-12
19 cm / 7½"



Watson-Williams
39-153-12
19 cm / 7½"



Takahashi
39-159-12
19 cm / 7½"

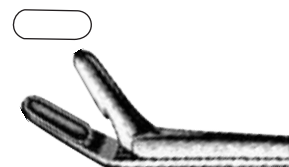

Takahashi
39-163-12
19 cm / 7½"

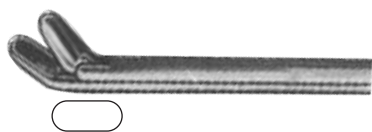





Watson-Williams
39-154-12
19 cm / 7½"

Nasal Cutting Forceps

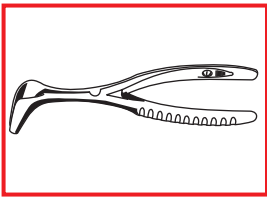
Scharfe Nasenzangen
Pinzas nasales cortantes

Pinces nasales coupantes
Pinze taglienti per il naso



-  39-169-01
-  39-169-02
-  39-169-03





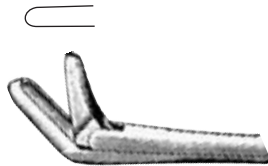

Myles
39-169-01 - 39-169-03
19 cm / 7½"

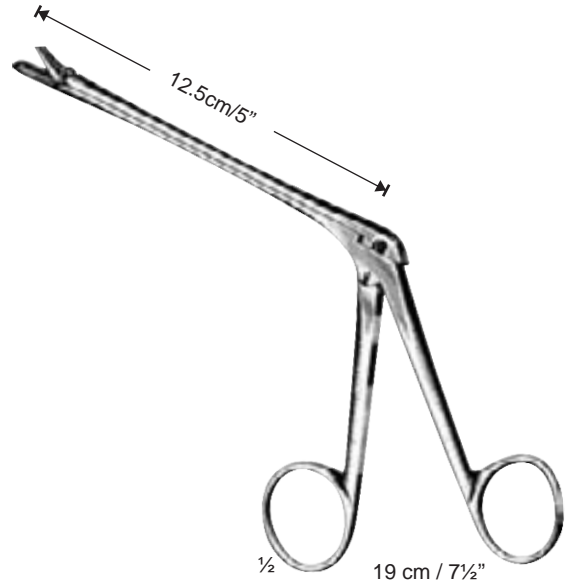

Hajek
39-171-12
19 cm / 7½"



-  39-173-01
5 mm
-  39-173-02
7 mm
-  39-173-03
9 mm
-  39-173-04
11 mm







Hartmann
39-173-01 - 39-173-04
19 cm / 7½"

-  39-175-01
-  39-175-02
-  39-175-03
1/1



Schmeden
39-175-01 - 39-175-03
19 cm / 7½"

-  39-177-01
2.2 mm
-  39-177-02
2.6 mm
-  39-177-03
3.0 mm
-  39-177-04
3.4 mm

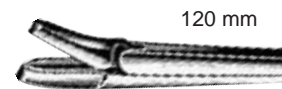

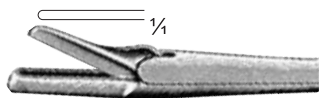

Myles
39-177-01 - 39-177-04
19 cm / 7½"



Struycken
39-179-01
19 cm / 7½"



Struycken
39-179-02
19 cm / 7½"

-  39-182-01
-  39-182-02
-  39-182-03
1/1



Gruenwald
39-182-01 - 39-182-03
19 cm / 7½"

Nasal Cutting Forceps

Scharfe Nasenzangen
Pinzas nasales cortantes

Pinces nasales coupantes
Pinze taglienti per il naso

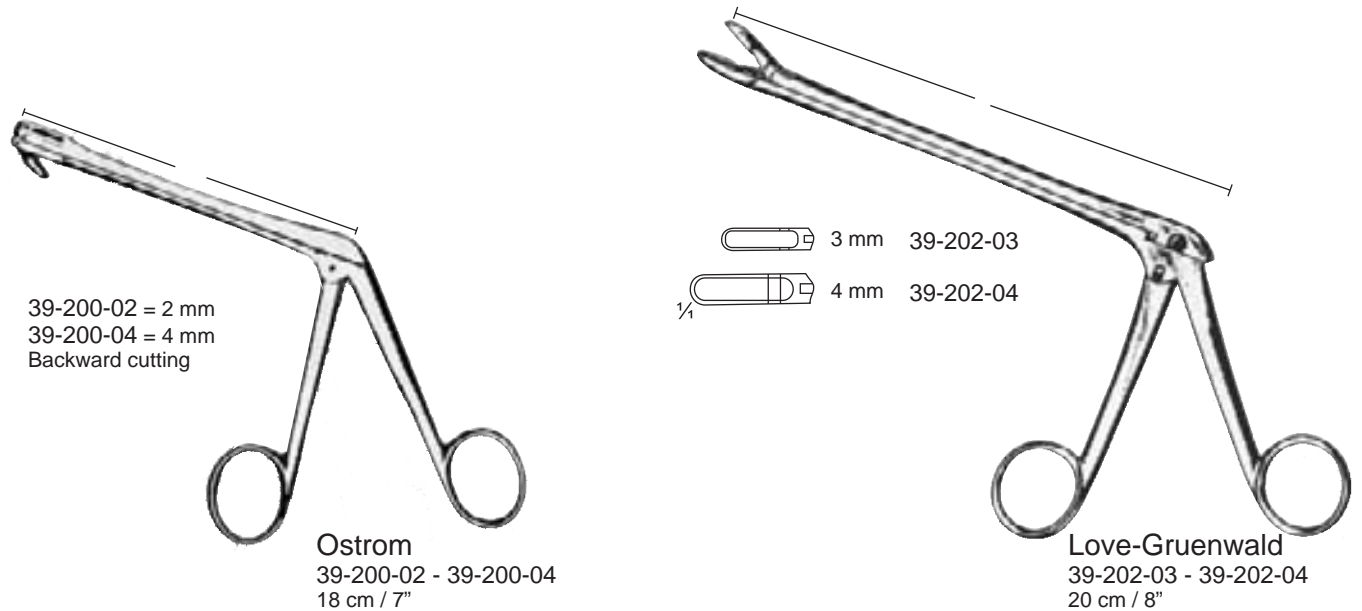
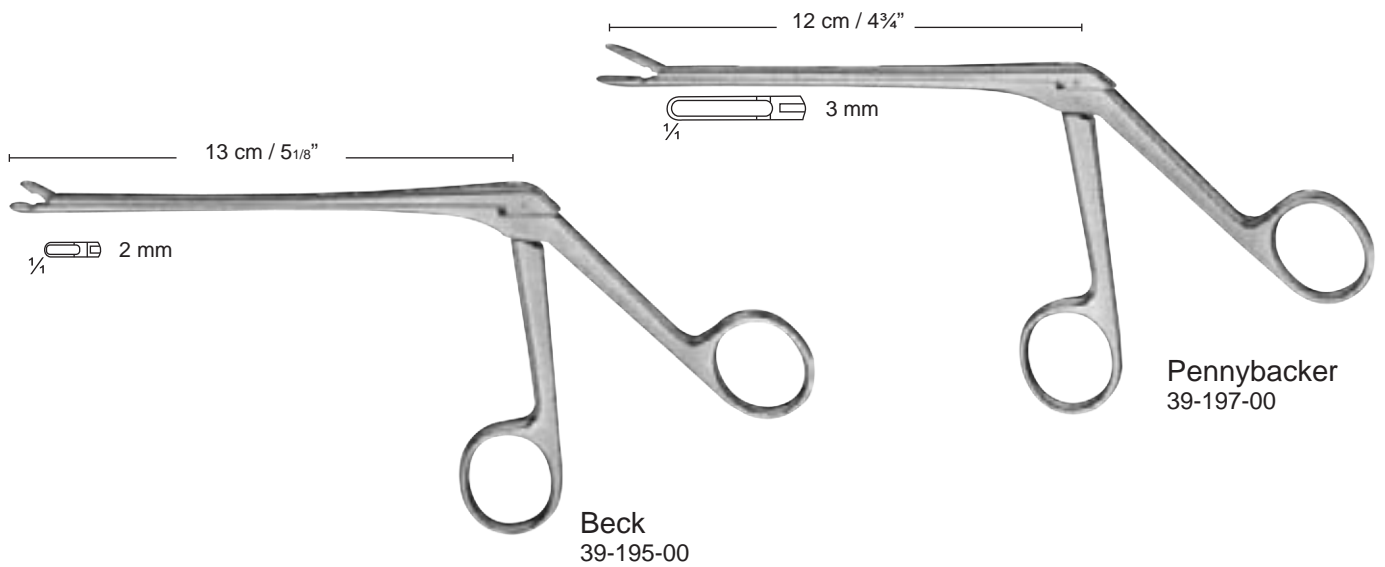
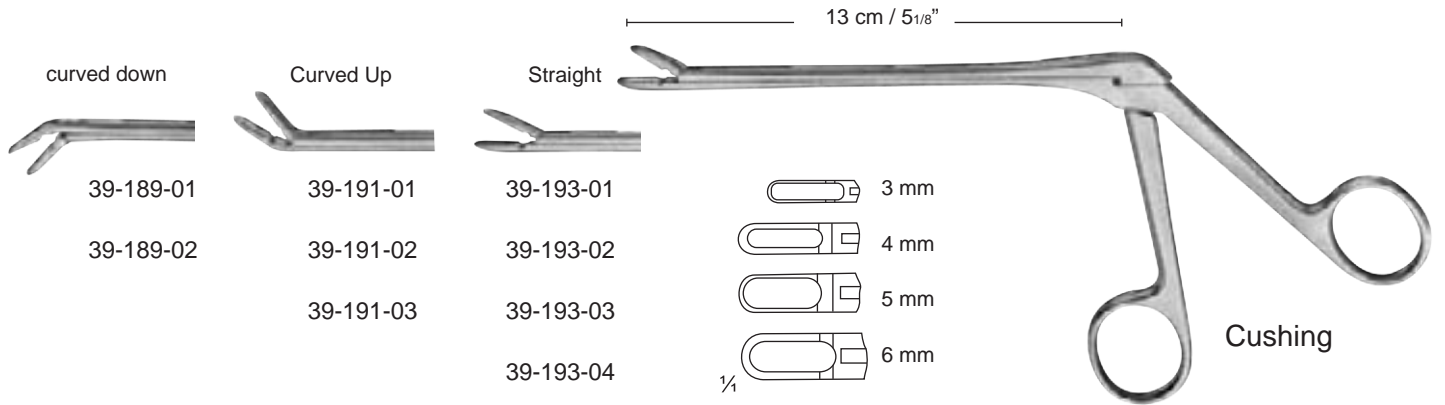
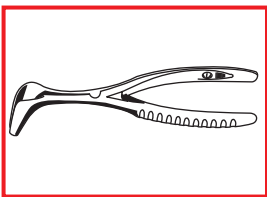

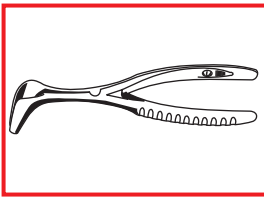

Nasal Cutting Forceps

Scharfe Nasenzangen
Pinzas nasales cortantes

Pinces nasales coupantes
Pinze taglienti per il naso

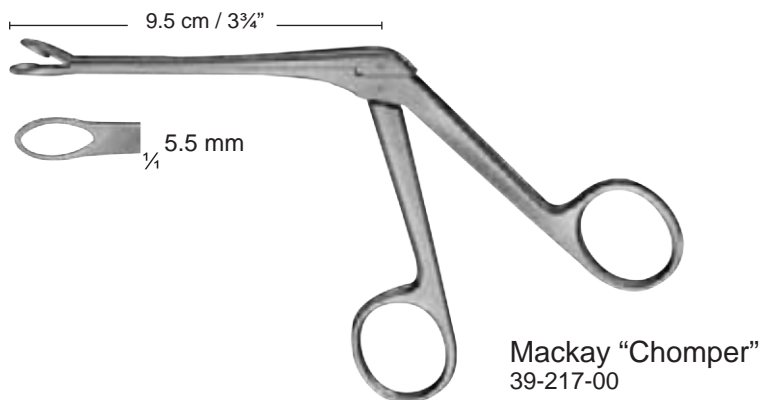
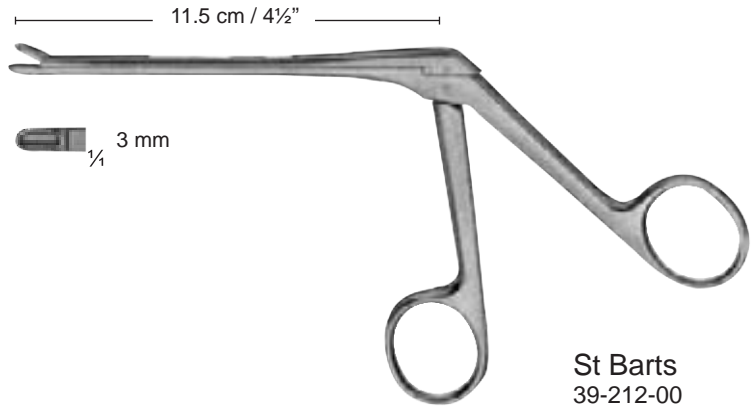
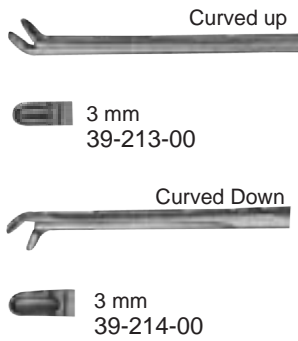
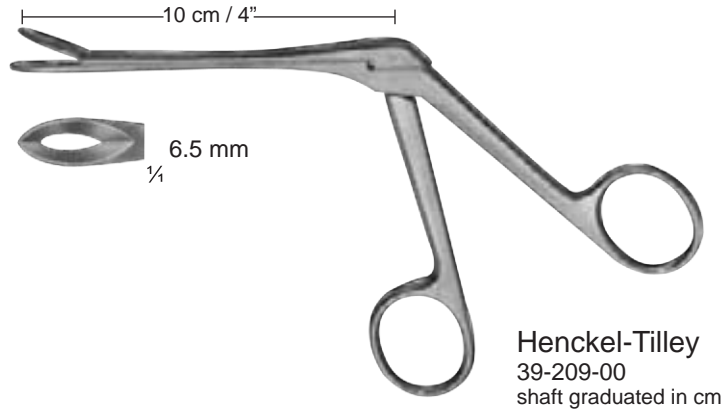

Nasal Cutting Forceps

Scharfe Nasenzangen
Pinzas nasales cortantes

Pinces nasales coupantes
Pinze taglienti per il naso

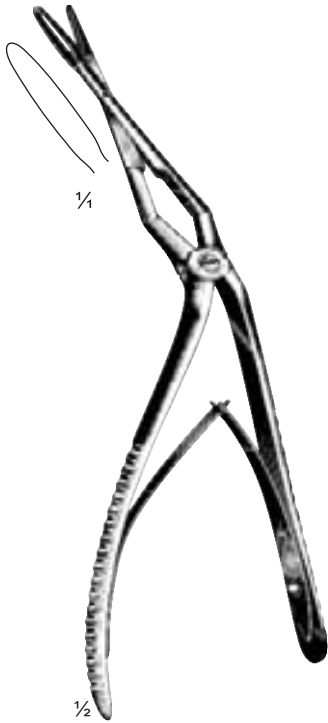
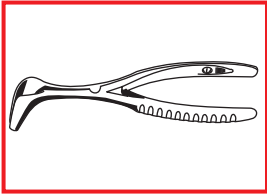

Jansen-Sturycken
39-225-19
19 cm / 7½"

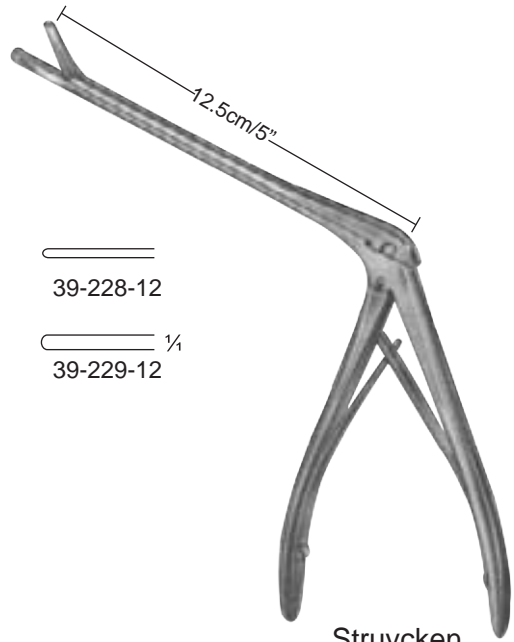

39-228-12

39-229-12

Struycken
39-228-12 - 39-229-12

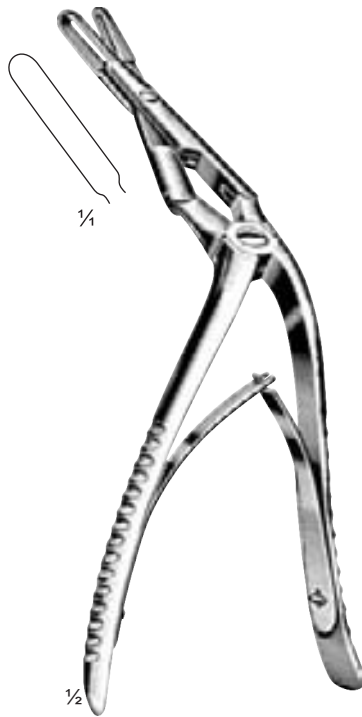

Middleton-Jansen
39-231-19
19 cm / 7½"

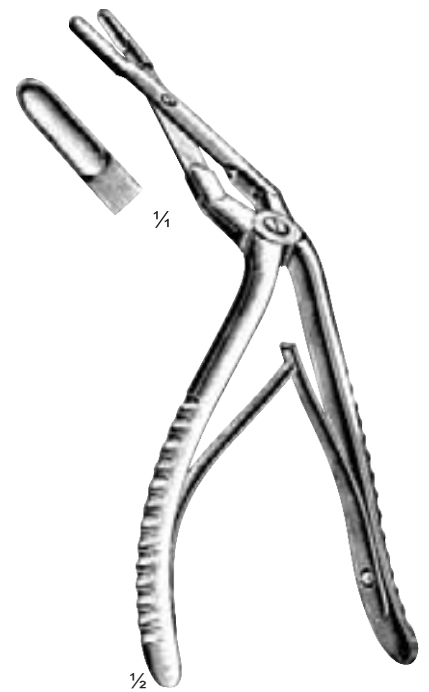

Middleton-Jansen
39-233-19
19 cm / 7½"

Septum Forceps

Septumzangen
Pinzas para tabique nasal

Pinces pour la cloison nasale
Pinze per il setto nasale



1/2

Caplan
39-239-20
20 cm / 8"



1/2

Killian
39-241-21
21 cm / 8 1/2"



1/2

Rubin
39-243-21
21 cm / 8 1/2"

Sphenoid Bone Punches

Keilbeinstanzen
Pinzas sacabocadas para esfenoides

Pinces emporte-pièces pour sinus sphénoïdal
Pinze taglienti per seno sfenoidale

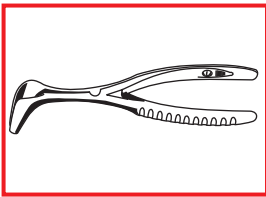

3 x 5 mm  39-250-18

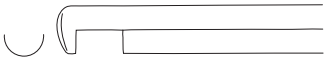
3 x 5 mm  39-251-18

5 x 5 mm  39-254-18

5 x 5 mm  39-255-18

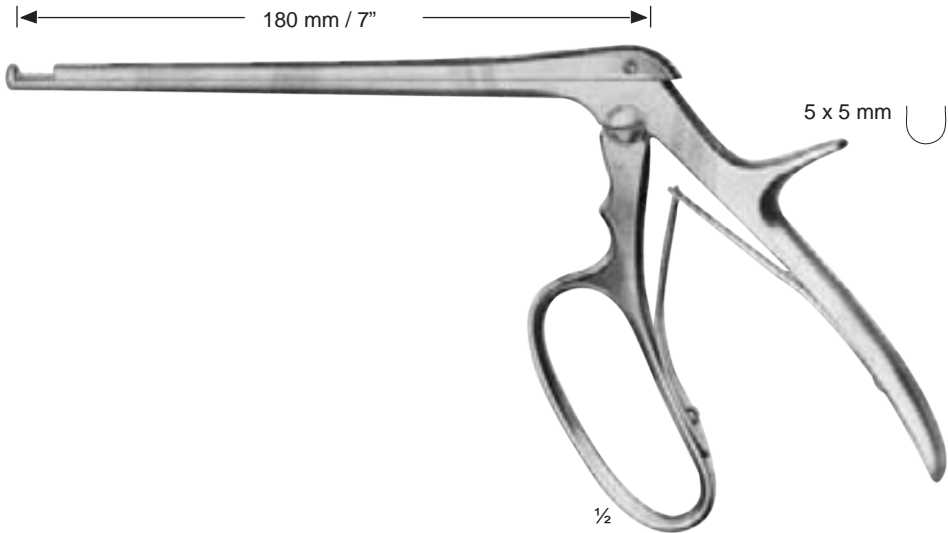

Ferris-Smith-Kerrison
39-250-18 - 39-255-18

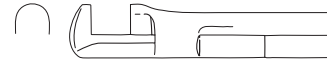

39-258-14 - 39-261-14

4 x 4 mm  Hajek
39-258-14

4 x 4 mm  Hajek
39-259-14

3.5 x 3.5 mm  Hajek-Kofler
39-260-14



3.5 x 3.5 mm  Hajek-Kofler
39-261-14

Sphenoid Bone Punches



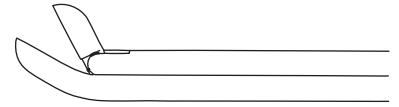
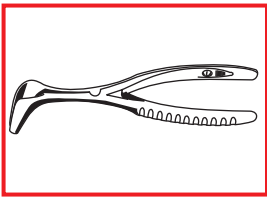

Keilbeinstanzen
Pinzas sacabocadas para esfenoides

Pinces emporte-pièces pour sinus sphénoïdal
Pinze taglienti per seno sfenoidale

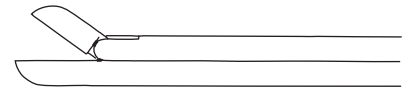



-  39-267-02 = 2 x 10 mm
-  39-267-03 = 3 x 10 mm curved up
-  39-267-04 = 4 x 10 mm

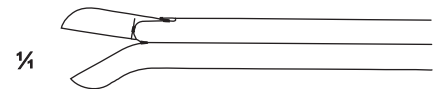

-  39-268-02 = 2 x 10 mm
-  39-268-03 = 3 x 10 mm
-  39-268-04 = 4 x 10 mm Straight
-  39-268-05 = 5 x 10 mm
-  39-268-06 = 6 x 10 mm



-  39-269-02 = 2 x 10 mm
-  39-269-03 = 3 x 10 mm curved down
-  39-269-04 = 4 x 10 mm

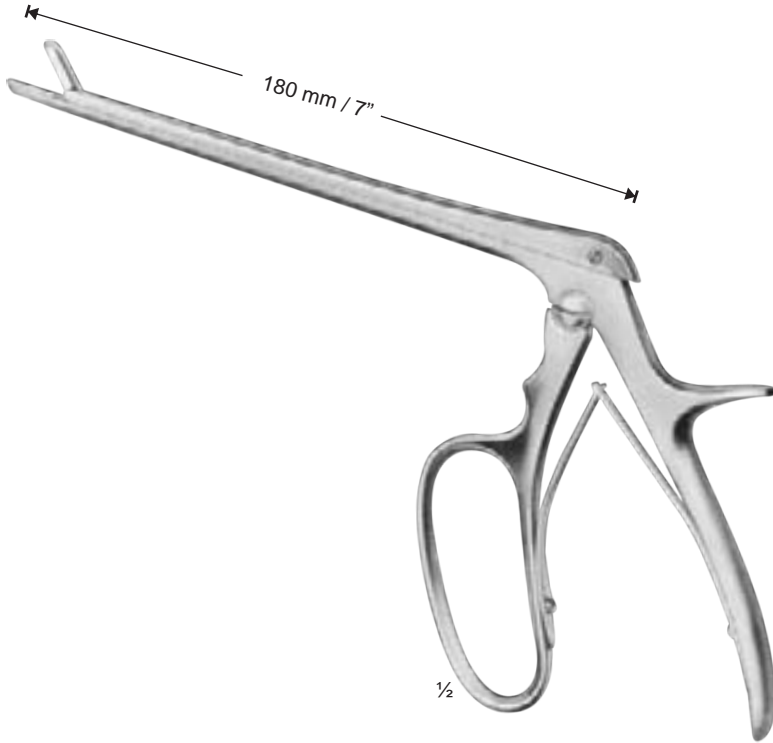

Ferris-Smith-Cushing
39-267-02 - 39-269-04

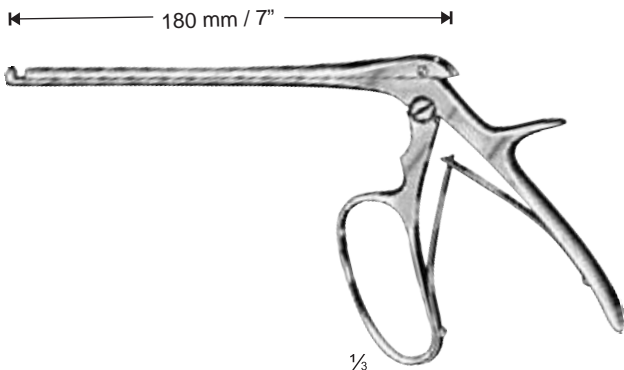

Ferris-Smith-Kerrison
(Cloward Harper)
39-272-03 - 39-272-05

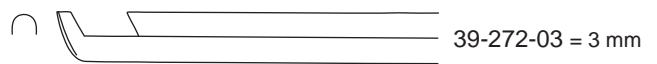

39-272-03 = 3 mm

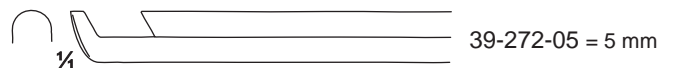

39-272-05 = 5 mm

Sphenoid Bone Punches

Keilbeinstanzen

Pinces emporte-pièces pour sinus sphénoïdal

Pinzas sacabocadas para esfenoides

Pinze taglianti per seno sfenoidale

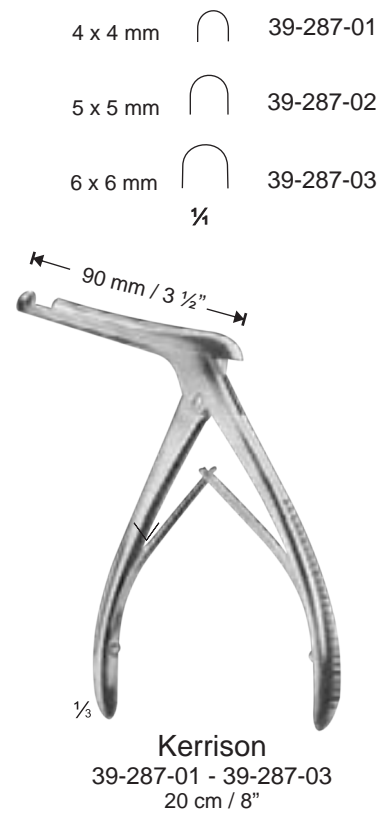
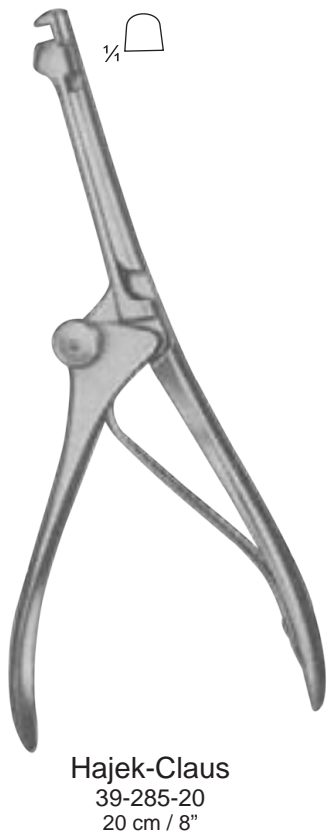
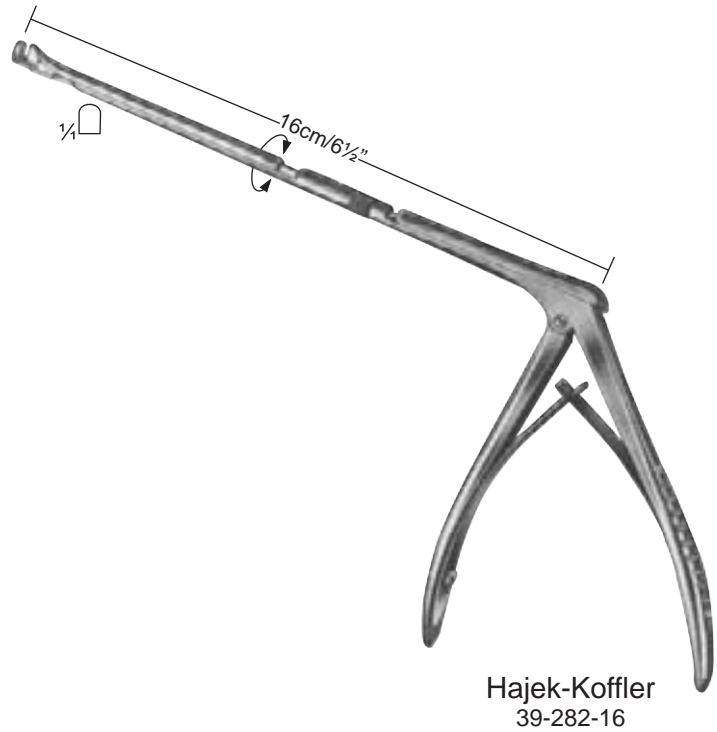
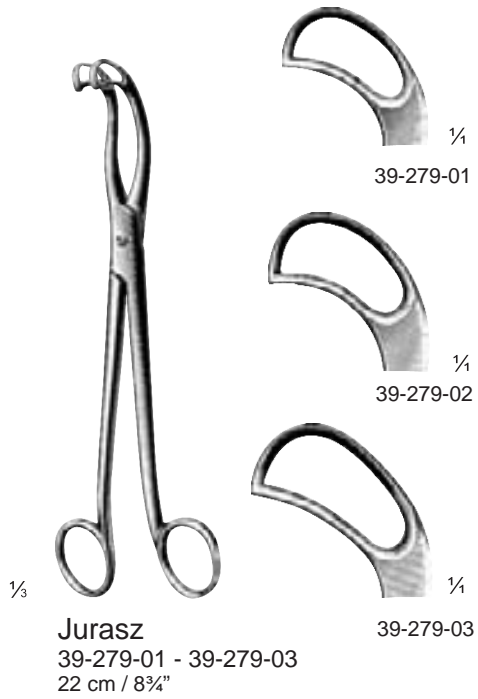



Rhinoplastic Knives

Rhinoplastik-Messer
Cuchillos para rinoplástica

Couteaux pour plastie du nez
Bisturi per plastica nasale

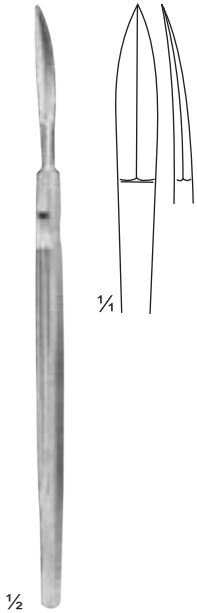

Fomon
39-294-16
16 cm / 6 1/4"

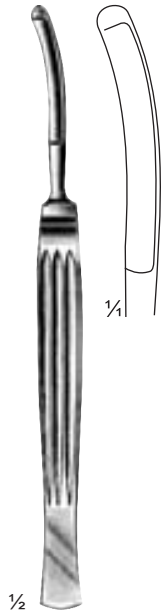

Converse
39-297-16
16 cm / 6 1/4"

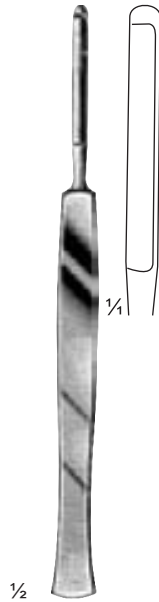

Joseph
39-300-15
15 cm / 6"



Cottle
39-302-15
15 cm / 6"

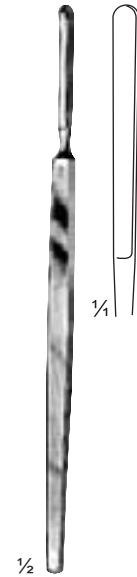

Cottle
39-304-15
15 cm / 6"

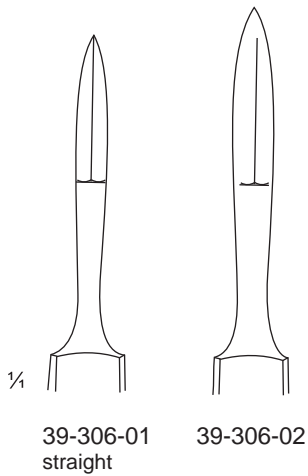

39-306-01
straight

39-306-02

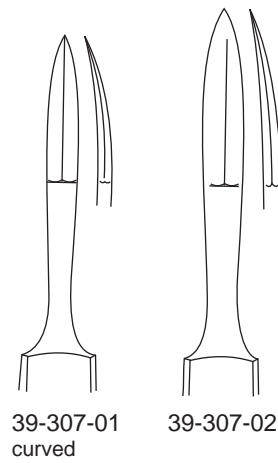

39-307-01
curved

39-307-02



Joseph
39-306-01 - 39-307-02
14.5 cm / 5 3/4"

Septum Knives, Swivel Knives

Septummesser, Schwingmesser
Cuchillos para tabique nasal

Bistouris Pour la cloison nasale
Bisturi per il setto nasale

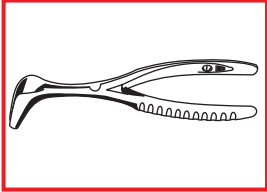

½
Masing
39-315-13
13 cm / 5"



½
Freer
39-318-15
15 cm / 6"



½
Freer
39-320-15
15 cm / 6"



½
Joseph
39-322-16
16.5 cm / 6½"



½
Maltz
39-325-16
16.5 cm / 6½"

Septum Knives, Swivel Knives

Septummesser, Schwingmesser
Cuchillos para tabique nasal

Bistouris Pour la cloison nasale
Bisturi per il setto nasale

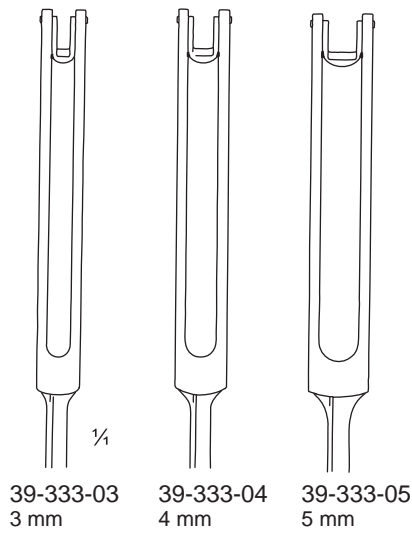
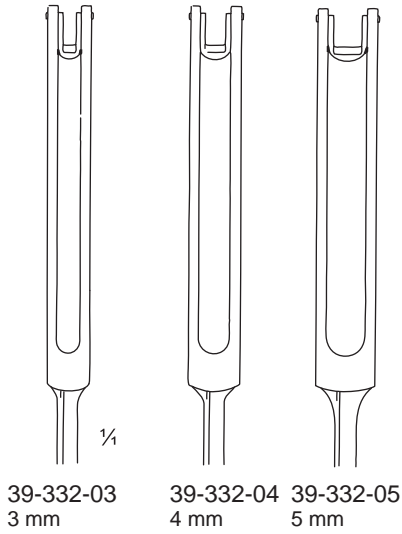
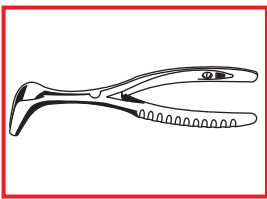

Ballenger
39-332-03 - 39-333-05
20 cm / 8"

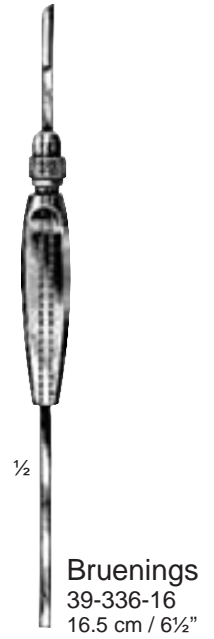

Septum Elevators, Periosteal Elevators

Septumelevatorien, Periostelevatorien
Elevadores para tabique nasal, Legras para periostio

Elévateurs pour la cloison nasale, Elévateurs pour le périoste
Elevatori per il setto nasale, Elevatori per il periostio



Freer
39-351-19
sharp
19 cm / 7½"

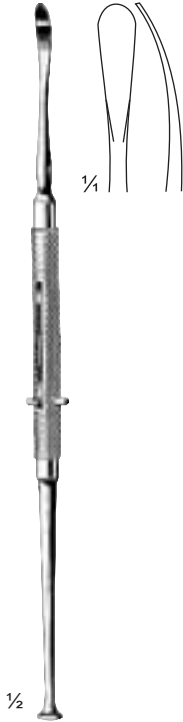

Freer
39-353-19
blunt
19 cm / 7½"



Freer
39-356-18
sharp-blunt
18 cm / 7"



Freer
39-359-20
sharp-blunt
20.5 cm / 8"

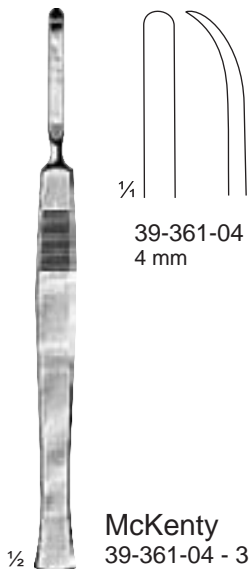

McKenty
39-361-04 - 39-361-05
15 cm / 6"

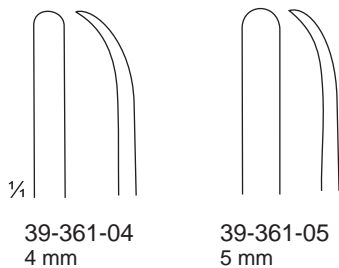

Halle
39-363-16
16.5 cm / 6½"

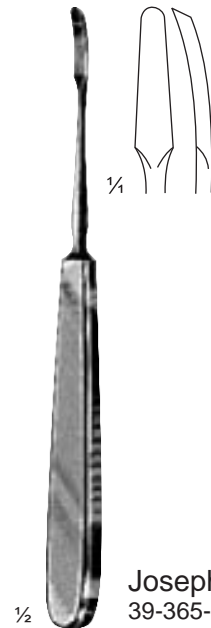

Joseph
39-365-16
16 cm / 6¼"

Septum Elevators, Periosteal Elevators

Septumelevatorien, Periostelevatorien
Elevadores para tabique nasal, Legras para periostio

Elévateurs pour la cloison nasale, Elévateurs pour le périoste
Elevatori per il setto nasale, Elevatori per il periostio

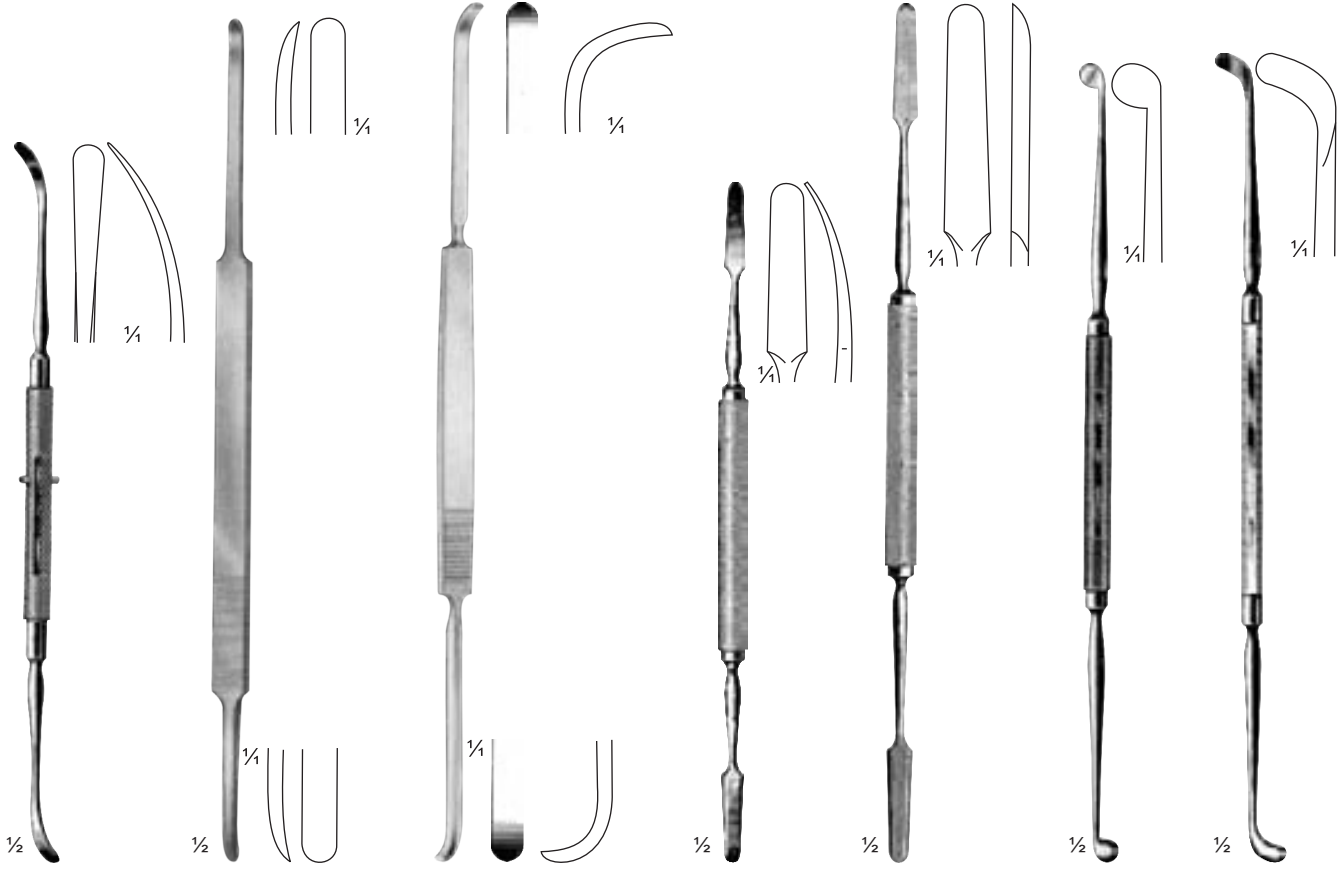

Roger
39-372-19
19 cm / 7½"

McKenty
39-375-22
22 cm / 8¾"

Cottle
39-377-23
23 cm / 9"

Killian
39-380-18
18 cm / 7"

Killian
39-382-22
22 cm / 8¾"

Pierce
39-384-21
21 cm / 8½"

Pennington
39-386-21
21 cm / 8½"

Septum Elevators, Periosteal Elevators

Septumelevatorien, Periostelevatorien
Elevadores para tabique nasal, Legras para periostio

Elévateurs pour la cloison nasale, Elévateurs pour le périoste
Elevatori per il setto nasale, Elevatori per il periostio

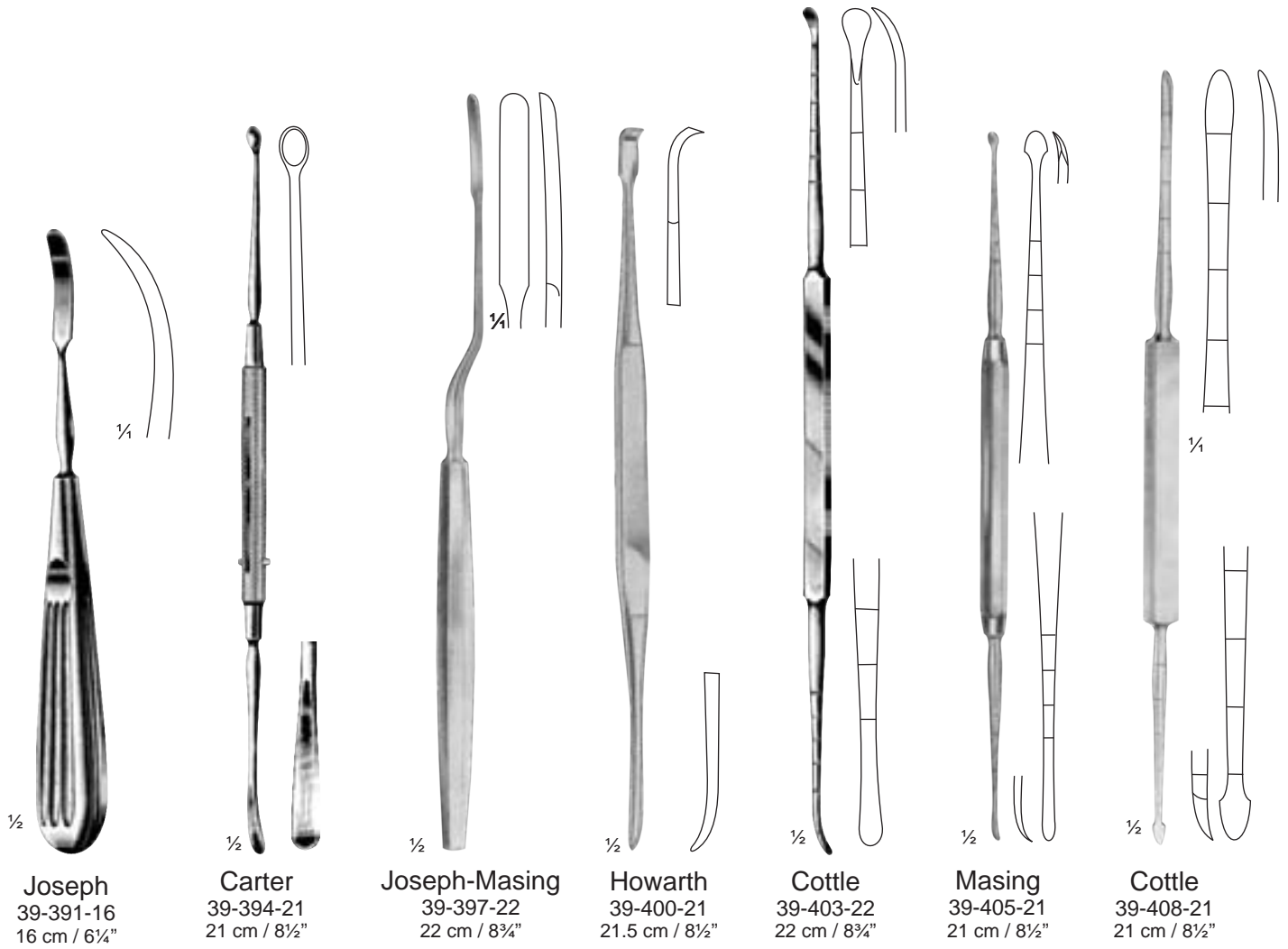

Joseph
39-391-16
16 cm / 6 1/4"

Carter
39-394-21
21 cm / 8 1/2"

Joseph-Masing
39-397-22
22 cm / 8 3/4"

Howarth
39-400-21
21.5 cm / 8 1/2"

Cottle
39-403-22
22 cm / 8 3/4"

Masing
39-405-21
21 cm / 8 1/2"

Cottle
39-408-21
21 cm / 8 1/2"

Gouges, Chisels

Hohlmeißel, Meißel
Gubias, Cinceles

Gouges, Ciseaux-burins
Sgorbie, Scalpelli

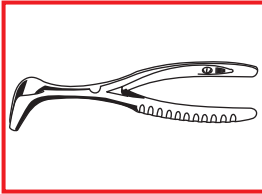

1/2
Freer
39-415-15
6 mm
15 cm / 6"



1/2
Killian
39-417-16
5 mm
16 cm / 6 1/4"



1/2
Killian-Claus
39-419-16
5 mm
16 cm / 6 1/4"

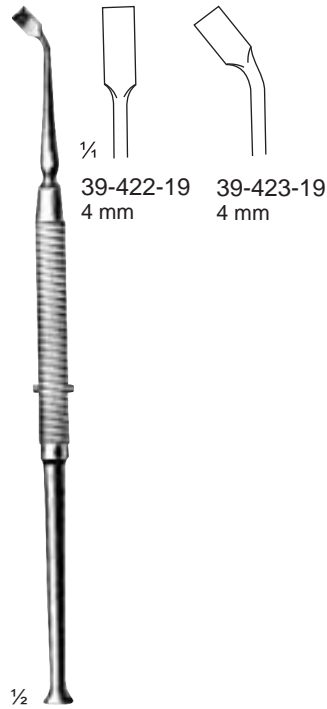

1/2
Freer
39-422-19 - 39-423-19
4 mm
19 cm / 7 1/2"



1/2
Freer
39-424-16
4 mm
16 cm / 6 1/4"



1/2
Freer
39-427-16
4 mm
16 cm / 6 1/4"



1/2
West
39-430-16
16 cm / 6 1/4"



1/2
West
39-431-16
16 cm / 6 1/4"



39-433-04
4 mm
39-433-06
6 mm
39-433-08
8 mm
1/2
Ballenger
39-433-04 - 39-433-08
16 cm / 6 1/4"



39-434-08
8 mm
39-434-10
10 mm
39-434-12
12 mm
39-434-15
15 mm
McIndoe
39-434-08 - 39-434-15
16 cm / 6 1/4"

Osteotomes

Osteotome Ostéotomes
 Osteótomos Osteotomi

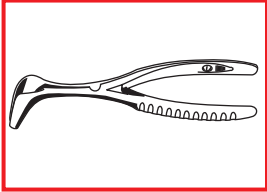

Cottle
 39-439-06
 18 cm / 7"



Cottle
 39-440-16
 18 cm / 7"

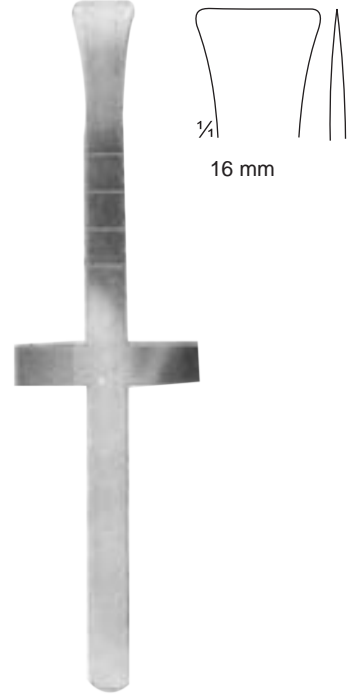

Cottle
 39-442-16
 18 cm / 7"

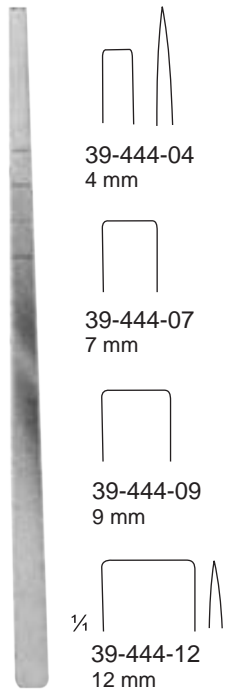

Cottle
 39-444-04 - 39-444-12
 18 cm / 7"



Cottle
 39-445-06
 18 cm / 7"

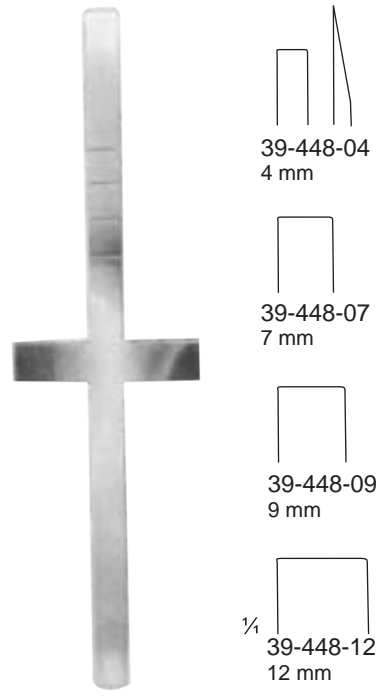

Cottle
 39-448-04 - 39-448-12
 18 cm / 7"

Osteotomes, Gouges, Chisels

Osteotome, Hohlmeißel, Meißel
Osteótomos, Gubias, Cinceles

Ostéotomes, Gouges, Ciseaux-burins
Osteotomi, Sgorbie, Scalpelli

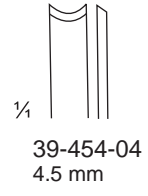
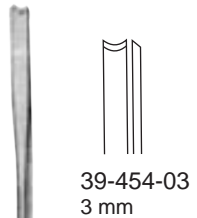
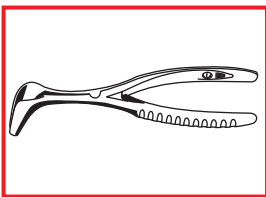

1/2
Walter
39-454-03 - 39-454-04
19 cm / 7 1/2"

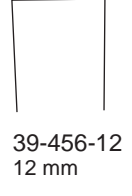
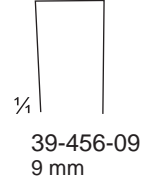
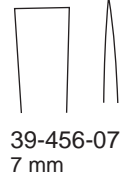
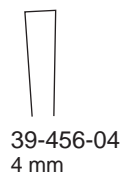
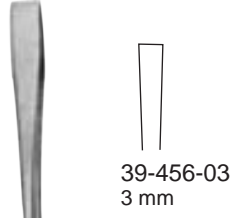

1/2
Walter
39-456-03 - 39-456-12
19 cm / 7 1/2"

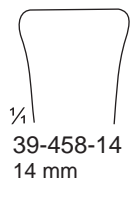
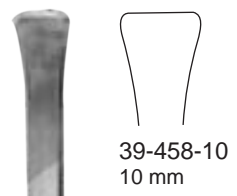

1/2
Rubin
39-458-10 - 39-458-14
18 cm / 7"

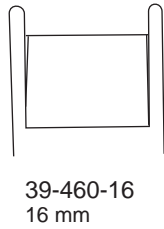
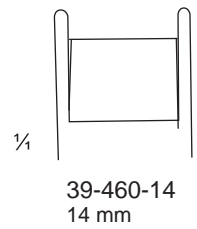
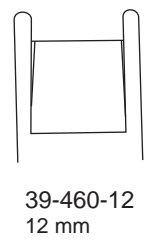
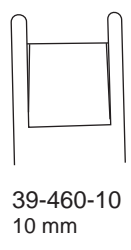

1/2
Cinelli
39-460-10 - 39-460-16
18 cm / 7"

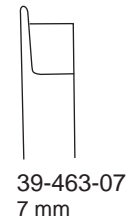
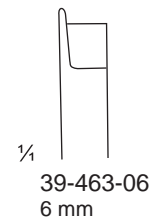
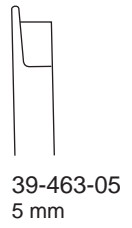
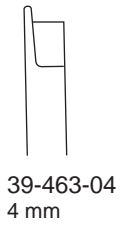

1/2
Fomon
39-463-04 - 39-463-07
17 cm / 6 3/4"

Rhinoplastic Chisels, Osteotomes

Nasenmeißel, Osteotome
Cinceles nasales, Osteótomos

Ciseaux-burins nasaux, Ostéotomes
ScalPELLI nasali, Osteotomi



Masing
39-471-00
17.5 cm / 7"



Masing
39-471-01
17.5 cm / 7"



Masing
39-471-02
17.5 cm / 7"



39-473-06
6 mm
39-473-08
8 mm
39-473-10
10 mm
39-473-12
12 mm
39-473-14
14 mm

Jenken
39-473-06-
39-473-14
14.5 cm / 5¾"



39-474-04
4 mm
39-474-05
5 mm

Kelsey-Fry
39-474-04-
39-474-05
15 cm / 6"



39-475-06
6 mm
39-475-08
8 mm
39-475-10
10 mm
39-475-12
12 mm
39-475-14
14 mm

Jenken
39-475-06 -
39-475-14
14.5 cm / 5¾"



Neivert
39-477-20
20 cm / 8"



Anderson-Neivert
39-477-01
20 cm / 8"



Anderson-Neivert
39-477-02
20 cm / 8"



Converse
39-480-00
19 cm / 7½"



Converse
39-480-01



Converse
39-480-02



39-482-03
3mm
39-482-05
5mm

Ward
39-482-03-
39-482-05
18 cm / 7"

Rhinoplastic Instruments

Instrumente zur Nasenplastik
Instrumentos para la plástica nasal

Instruments pour la plastique nasale
Strumenti per la plastica nasale

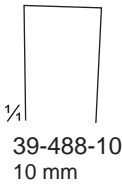
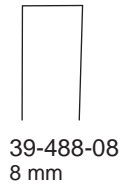
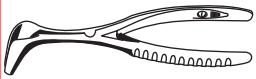

1/2
Sheehan
39-488-07 - 39-488-12
17 cm / 6 3/4"

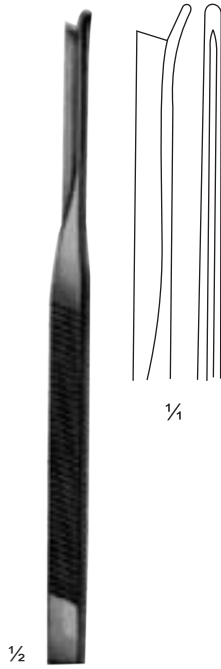

39-490-01
Silver
39-490-01 - 39-490-03
18 cm / 7"

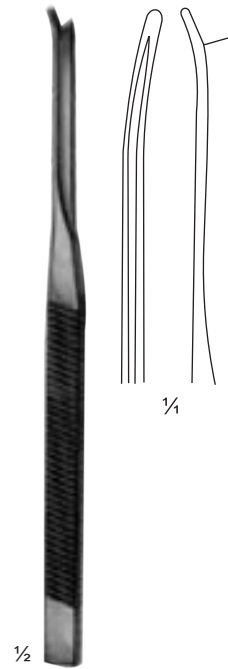

39-490-02

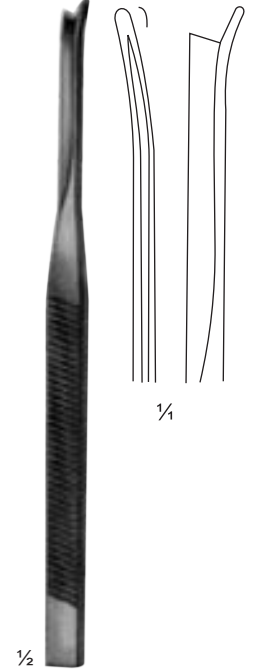

39-490-03

39-493-20



1/2

Joseph
39-493-20 - 39-495-20
17 cm / 6 3/4"

39-495-20



Joseph
39-497-00 - 39-497-02
19 cm / 7 1/2"

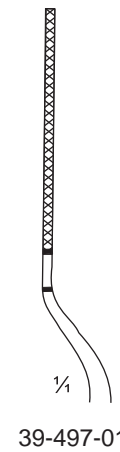
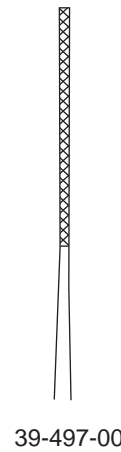

1/4

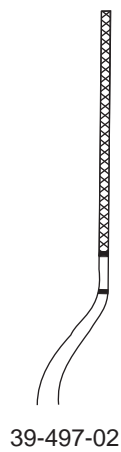



Cartilage Crusher

Knorpelquetsche
Machacadora

Pinces-gouge à cartilage
Torchio per cartilagine

39-502-00 = 39-502-01 + 39-502-02



Cottle
39-502-01
12 cm / 4¾"



Cottle
39-502-02
7 mm wide



Cottle
39-504-00
65 x 30 x 30 mm



Boies
39-507-18
18 cm / 7"



Goldmann
39-508-20
20 cm / 8"

Rhinoplastic Instruments

Instrumente zur Nasenplastik
Instrumentos para la plástica nasal

Instruments pour la plastique nasale
Strumenti per la plastica nasale

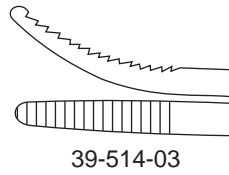
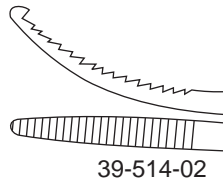
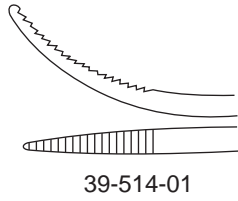

Waston-Williams
39-514-01
39-514-02
39-514-03
17 cm / 6¾"
(Sinus Rasp)



Myle
39-515-01 = 16F.G
39-515-02 = 19F.G
17 cm / 6¾"
(Perforator)



Tilley
39-518-00
(Harpoon Trocar) ø 4 mm
17 cm / 6¾"



Tilley
39-519-01 = 6 mm ø diam
39-519-02 = 7 mm ø diam
39-519-03 = 8 mm ø diam
(AntrumBurs)
17 cm / 6¾"

Nasal Rasps, Bone Files

Nasenraspeln, Knochenfeilen
Escofinas nasales, Limas para huesos

Râpes nasales, limes à os
Raspe nasali, Lime per ossa

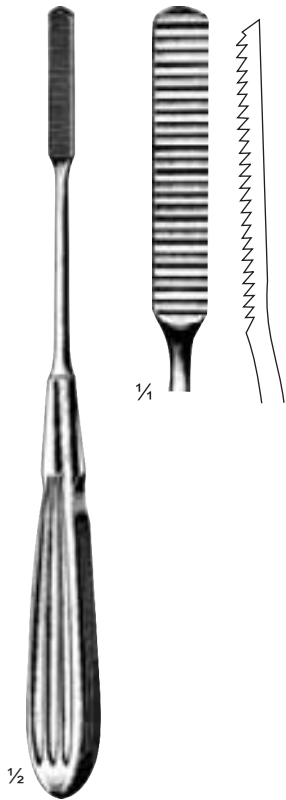

Cottle
39-524-21
21 cm / 8¼"

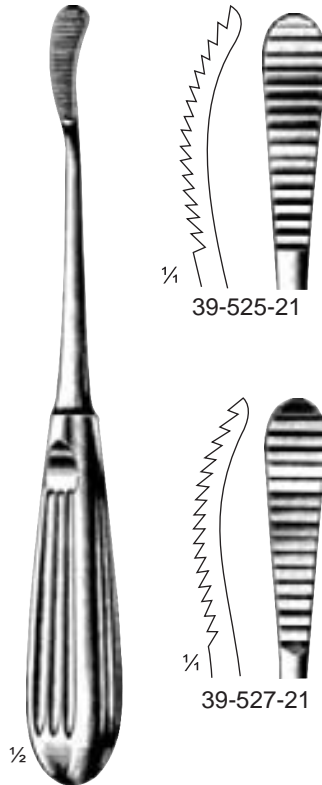

Aufricht
21 cm / 8¼"

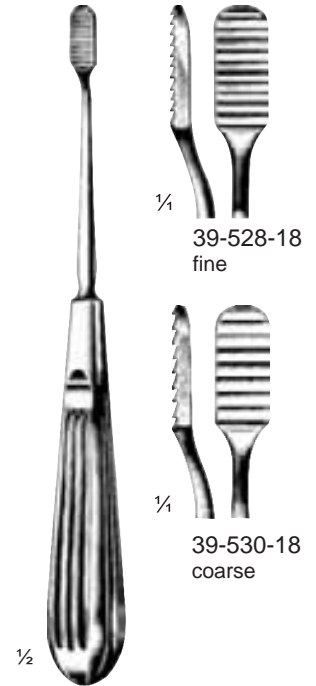

Lewis
18 cm / 7"

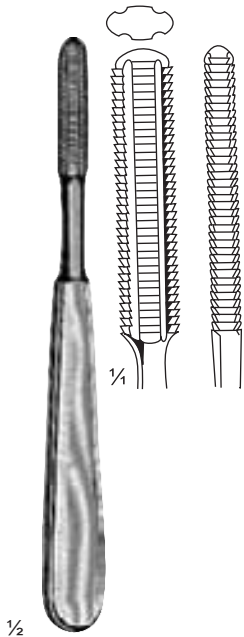

Maltz
39-532-18
18 cm / 7"

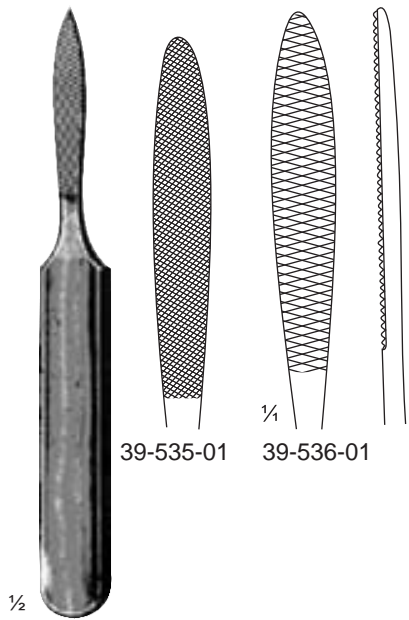

Joseph
39-535-01 - 39-536-01
16 cm / 6¼"

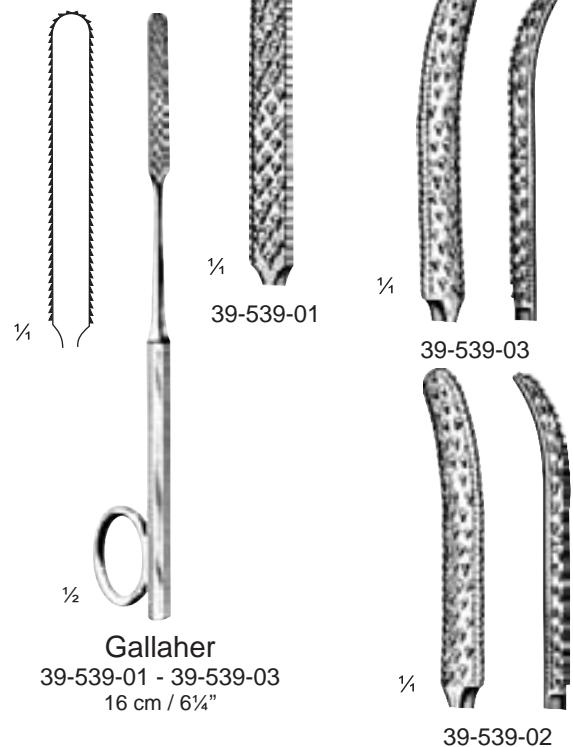

Gallaher
39-539-01 - 39-539-03
16 cm / 6¼"

Nasal Rasps, Bone Files

Nasenraspeln, Knochenfeilen
 Escofinas nasales, Limas para huesos

Râpes nasales, limes à os
 Raspe nasali, Lime per ossa



1/2
Wiener
 39-543-18 - 39-545-18
 18 cm / 7"

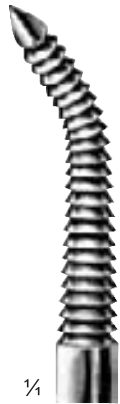

1/4
 39-543-18

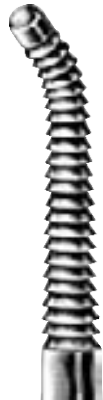

39-545-18

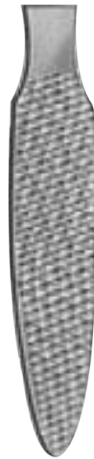

1/2



Converse
 39-548-18
 18.5 cm / 7 1/4"



1/2
Masing
 39-552-21
 21 cm / 8 1/4"

6.5 mm



1/2
Masing
 39-555-21
 21 cm / 8 1/4"

6.5 mm



1/2
Fomon
 39-558-21
 21 cm / 8 1/4"

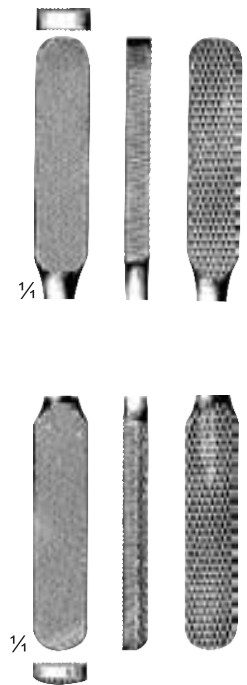

1/4

1/4

Nasal Rasps

Nasenraspeln
Escofinas nasales

Râpes nasales,
Raspe nasali



½

Miller-Colburn
39-564-01- 39-564-05
19 cm / 7½"



Fig. 01
39-564-01



Fig. 02
39-564-02



Fig. 03
39-564-03



Fig. 04
39-564-04



Fig. 05
39-564-05



Miller-Colburn
39-565-01- 39-565-05
19 cm / 7½"



Fig. 01
39-565-01



Fig. 02
39-565-02



Fig. 03
39-565-03



Fig. 04
39-565-04

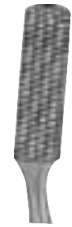

Fig. 05
39-565-05



Nasal Rasps

Nasenraspeln
Escofinas nasales

Râpes nasales,
Raspe nasali

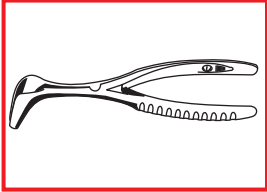

TC Lined
Mit TC-Einsätzen
Con bocas TC
A mors TC
Con morso TC

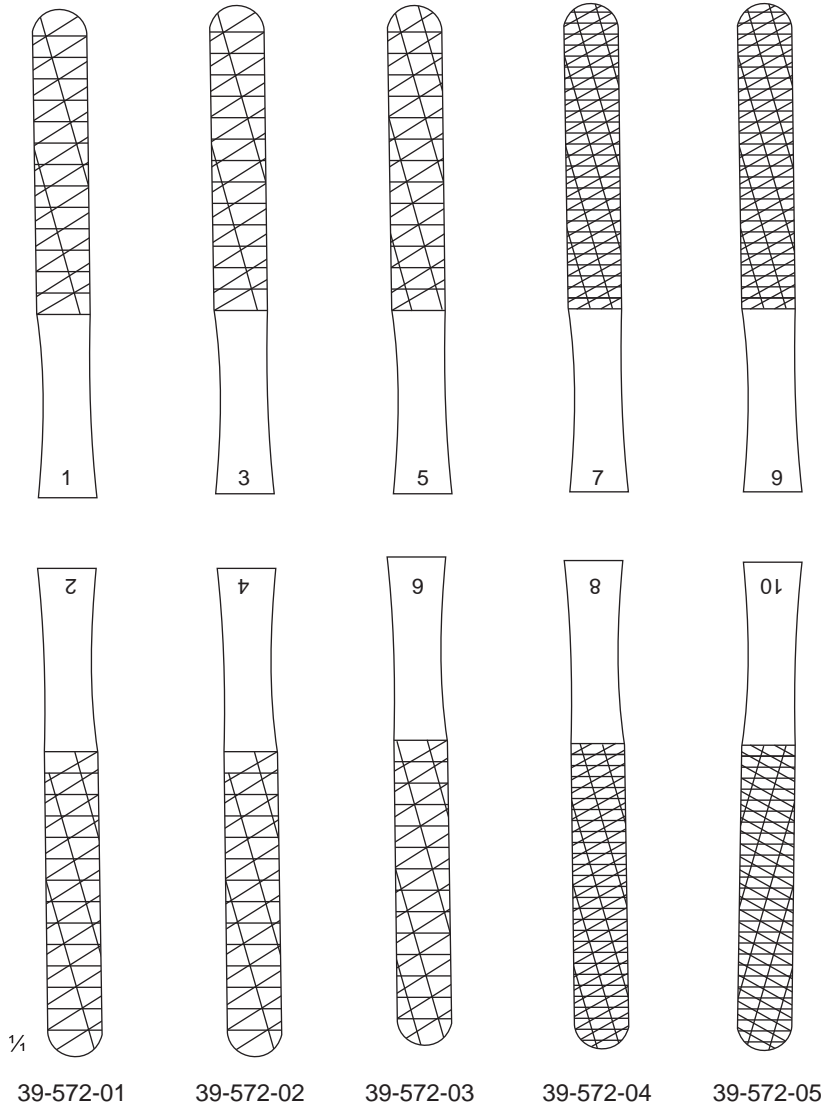

Fomon
39-572-01 - 39-572-05
20 cm / 8"

Nasal Rasps

Nasenraspeln
Escofinas nasales

Râpes nasales,
Raspe nasali

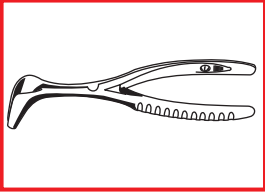

TC Lined
Mit TC-Einsätzen
Con bocas TC
A mors TC
Con morso TC

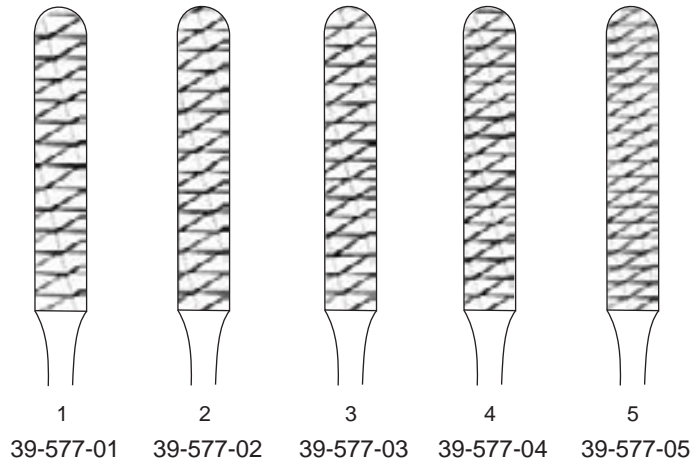

1 39-577-01 2 39-577-02 3 39-577-03 4 39-577-04 5 39-577-05

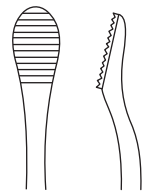

39-579-18

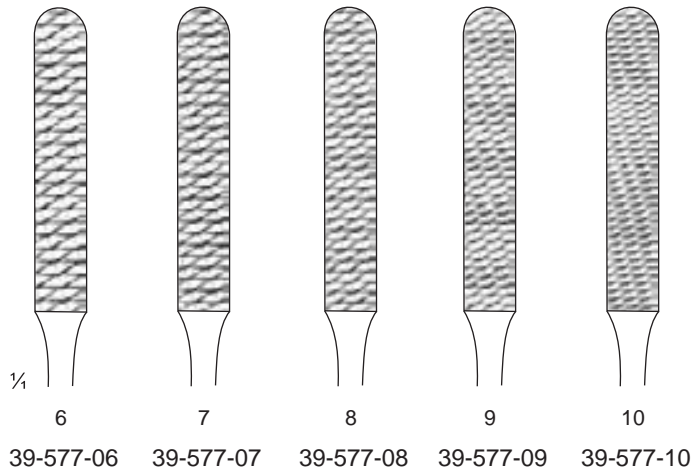

1/4 6 39-577-06 7 39-577-07 8 39-577-08 9 39-577-09 10 39-577-10

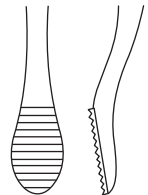

39-581-18

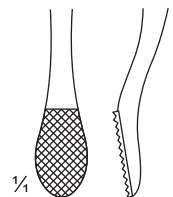
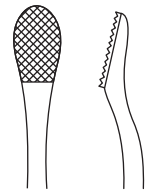

1/4



1/2

Maltz
39-577-01 - 39-577-10
18 cm / 7"



1/2

Miller
39-579-18 - 39-581-18
18 cm / 7"

Nasal Hooks, Nasal Retractors

Nasenhäkchen, Nasenhaken
Ganchitos nasales, Separadores nasales

Crochets nasaux, Ecarteurs nasaux
Uncini nasali, Divaricatori nasali

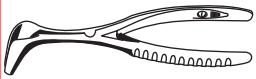

Fomon
39-588-17
17 cm / 6¾"



Cottle
39-590-14
14 cm / 5½"



Neivert
39-592-16
16 cm / 6¼"



Kilner
39-594-10
10 cm / 4"



Converse
39-596-12
12 cm / 4¾"



Freer
39-598-15
15 cm / 6"



Cottle
39-601-15
15 cm / 6"



Cottle
39-602-15
15 cm / 6"



Cottle
39-604-16
16 cm / 6¼"



39-606-01 - 39-606-03
15 cm / 6"



39-606-01

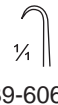

39-606-02



39-606-03



Jaeger
39-609-13
13.5 cm / 5¼"



Lange
39-612-22
22 cm / 8¾"



Fränkel-Neivert
39-614-23
23 cm / 9"

Alar Hooklets, Nasal Retractors

Nasenflügelhäkchen, Nasenhaken
Ganchitos para alas de nariz, Separadores nasales

Crochets pour les ailes du nez , Ecarteurs nasaux
Uncini per le pinne nasali, Divaricatori nasali

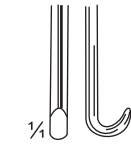
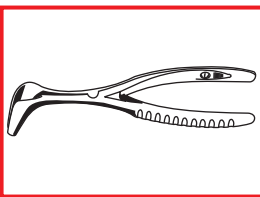

Cottle-Neivert
39-621-20
20 cm / 8"



Müller
39-623-15
15 cm / 6"

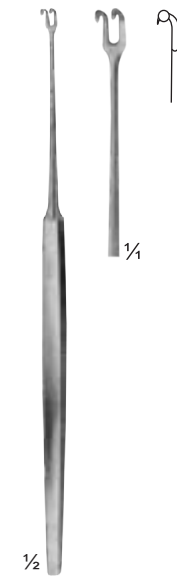

Müller
39-625-15
15 cm / 6"



Cottle
39-628-14 - 39-629-02
14 cm / 5½"



39-628-14



39-629-01



39-629-02



Joseph
39-632-15
15 cm / 6"



Joseph
39-634-02 - 39-634-10
16 cm / 6¼"



39-634-02
2 mm



39-634-05
5 mm



39-634-07
7 mm



39-634-10
10 mm



39-637-15
9 mm



39-638-15
10 mm

MC Indoe
39-637-15 - 39-638-15
15 cm / 6"



Fomon
39-640-16
16 cm / 6¼"



Rhinoplastic Instruments

Instrumente zur Nasenplastik
Instrumentos para la plástica nasal

Instruments pour la plastique nasale
Strumenti per la plastica nasale

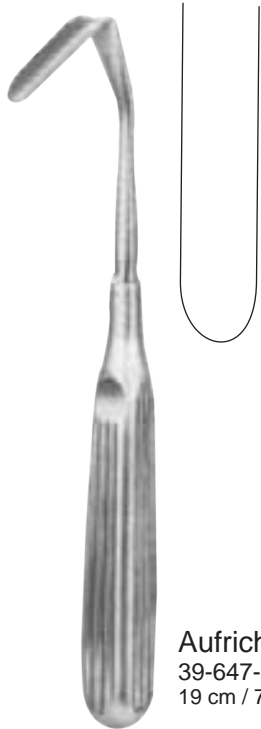

Aufricht
39-647-19
19 cm / 7½"



Aufricht (Walter)
39-649-14
13.5 cm / 5¼"



Yankauer
39-651-01 - 39-651-09
17 cm / 6¾"

Septum Straightening Forceps

Septumrichtzangen
Pinzas para enderezar el tabique nasal

Pinces pour le redressement de la cloison nasale
Pinze per raddizzare il setto nasale



1/2

Cottle-Walsham
39-658-01 - 39-658-03
23 cm / 9"

39-658-01

39-658-02

1/4

39-658-03



1/2

Asch
39-661-23
23 cm / 9"



1/2

Kressner
39-663-01 - 39-663-03
20 cm / 8"

39-663-01
2.5 x 60 mm

39-663-02
4 x 70 mm

39-663-03
5 x 75 mm



Kressner
39-665-20
20 cm / 8"



Skin Grasping Forceps

Hautfasspinzetten
Pinzas para piel

Pinces pour saisir la peau
Pinze per afferrare la pelle



Fox
39-672-13 = 13 cm / 5 1/8"
39-672-15 = 15 cm / 6"



Fox
39-674-13 = 13cm/5 1/8"
39-674-15 = 15cm/6"



Fox
39-676-13
13 cm / 5 1/8"



Fox
39-678-15
15 cm / 6"



Fox
39-680-16
15.5 cm / 6 1/8"



Cottle
39-682-10
10 cm / 4"



Cottle
39-685-14
14 cm / 5 1/2"



Ogura
39-688-11
11 cm / 4 1/4"

Sharp Currettes

Küretten
Curetas cortantes

Curettes tranchantes
Curette taglianti



1/2

Coakley

39-695-01 - 39-695-06
17 cm / 6 3/4"



1/4

39-695-01
Fig. 1



1/4

39-695-02
Fig. 2

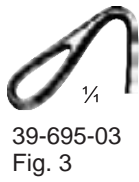

1/4

39-695-03
Fig. 3



1/4

39-695-04
Fig. 4



1/4

39-695-05
Fig. 5



1/4

39-695-06
Fig. 6



1/4



Pratt

39-697-21
21 cm / 8 1/4"



Sewall

39-699-20
20 cm / 8"

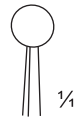

1/4



1/2

Faulkner

39-701-21
21 cm / 8 1/4"



1/2

39-703-20
20 cm / 8"



Adenoid Curettes

Ringmesser
Cuchillos para adenoides

Couteaux à végétations adénoïdales
Coltelli per vegetazioni adenoidee

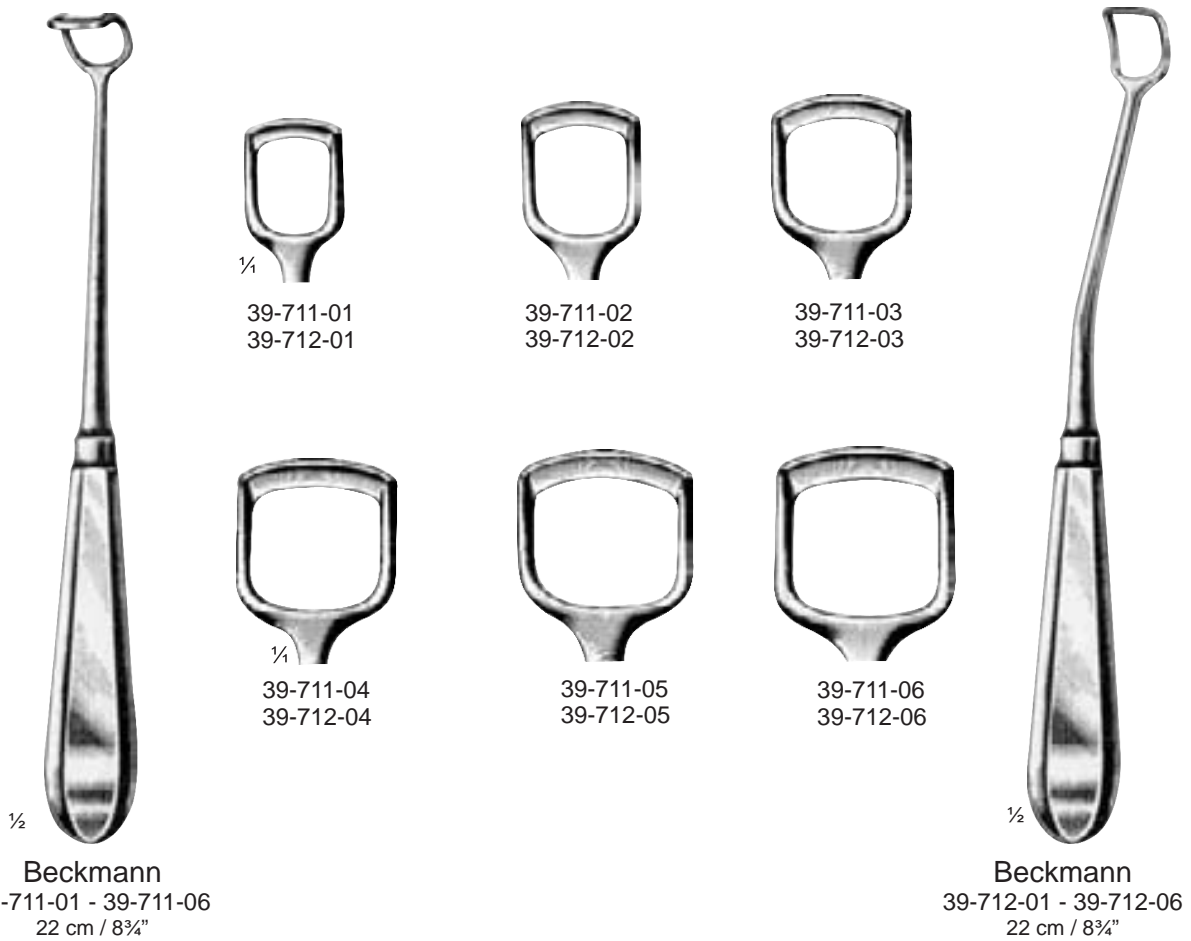

1/4

39-711-01
39-712-01

39-711-02
39-712-02

39-711-03
39-712-03

1/4

39-711-04
39-712-04

39-711-05
39-712-05

39-711-06
39-712-06

1/2

Beckmann
39-711-01 - 39-711-06
22 cm / 8 3/4"

1/2

Beckmann
39-712-01 - 39-712-06
22 cm / 8 3/4"

Adenoid Curettes

Ringmesser

Cuchillos para adenoides

Couteaux à végétations adénoïdales

Coltelli per vegetazioni adenoidee



1/2

St. Clair-Thomson
39-719-01 - 39-719-04
21 cm / 8 1/4"



1/4

39-719-01



39-719-02



39-719-03



39-719-04



1/2

Barnhill
39-724-01-
39-724-04
22 cm / 8 3/4"

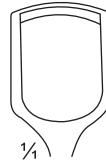

1/4

39-724-01

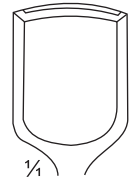

1/4

39-724-02

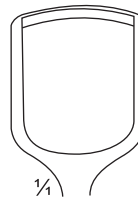

1/4

39-724-03

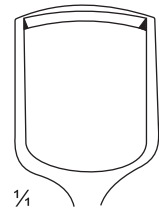

1/4

39-724-04

Adenotomes, Antrum Retractors

Tonsillotome, Antrum wundhaken
Adenótomos, Separadores antro

Adénotomes, Ecarteurs pour antre
Adenotomi, Divaricatori per seno maseellare

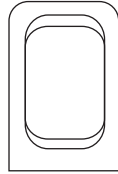
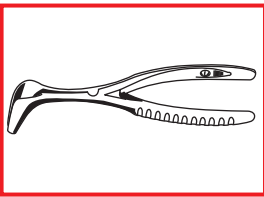

Fig. 1

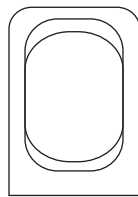
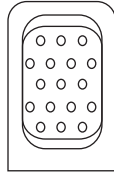

Fig. 2

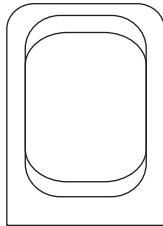
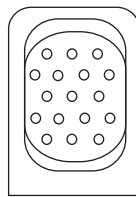
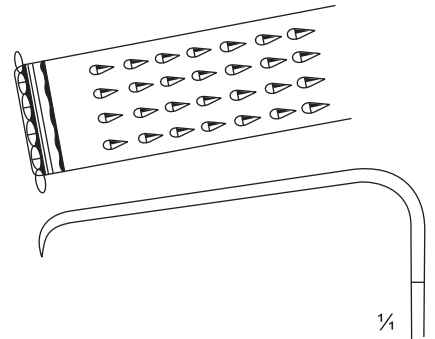
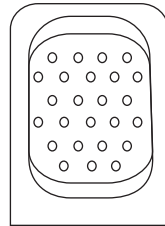

Fig. 3



1/2

La Force
39-731-01 - 39-733-03
25 cm / 10"

with unperforated blade	Fig.	with perforated blade
39-731-01	1	39-733-01
39-731-02	2	39-733-02
39-731-03	3	39-733-03

Spare Blades for 39-731-01 - 39-733-03

39-735-01	1	39-736-01
39-735-02	2	39-736-02
39-735-03	3	39-736-03



Bruenings-Brunk
39-737-19
19 cm / 7 1/2"

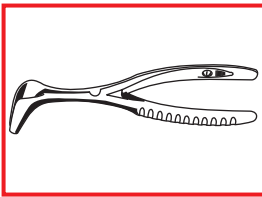

Antrum Irrigation Cannulas, Frontal Sinus Dilators

Spülkatheter, Sinus-Dilatatoren
 Catéteres lavadores, Dilatadores Para el seno

Sondes pour lavage, Dilatateurs pour le sinus frontal
 Cateteri per lavaggio, Dilatatori per il seno frontale

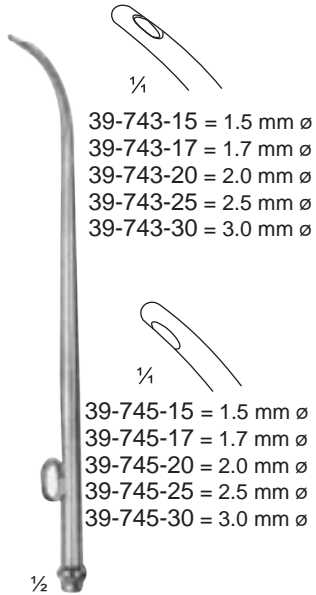

39-743-15 = 1.5 mm ø
 39-743-17 = 1.7 mm ø
 39-743-20 = 2.0 mm ø
 39-743-25 = 2.5 mm ø
 39-743-30 = 3.0 mm ø

39-745-15 = 1.5 mm ø
 39-745-17 = 1.7 mm ø
 39-745-20 = 2.0 mm ø
 39-745-25 = 2.5 mm ø
 39-745-30 = 3.0 mm ø

Siebenmann
 39-743-15 - 39-745-30
 15 cm / 6"



Ritter-Halle
 39-747-25 = 2.5 mm ø
 39-747-30 = 3.0 mm ø
 39-747-40 = 4.0 mm ø
 14.5 cm / 5 3/4"



Guilen
 39-750-20
 20 cm / 8"

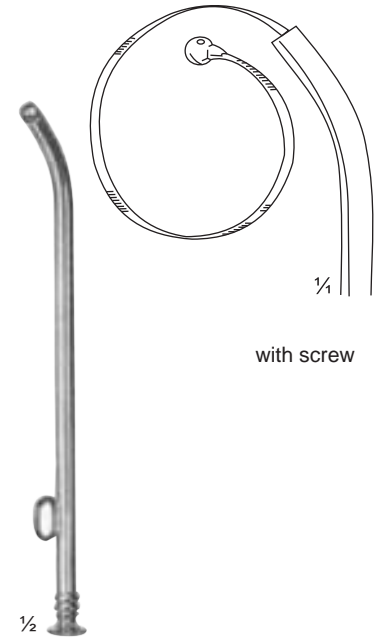

Bellocq
 39-753-14
 14 cm / 5 1/2"

with screw



Hajek
 39-756-15 = 1.5 mm ø
 39-756-20 = 2.0 mm ø
 17 cm / 6 3/4"

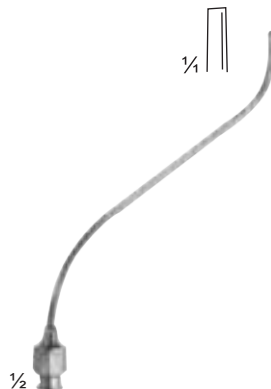

Hartmann
 39-759-20 = 2.0mmø
 39-759-25 = 2.5mmø
 39-759-30 = 3.0mmø
 12 cm / 4 3/4"



Myles
 39-762-09 = 9 cm / 3 1/2"
 39-762-20 = 11.5 cm / 4 1/2"
 1.8 mm ø



Eicken-Killian
 39-765-30
 3 mm ø
 14 cm / 5 1/2"



Eicken-Killian
 39-767-30
 3 mm ø
 14 cm / 5 1/2"



Killian
 39-769-15
 1 1/2 mm ø
 17 cm / 6 3/4"

Atomizers

Zerstäuber
Atomizadores

Pulvérisateurs
Polverizzatori

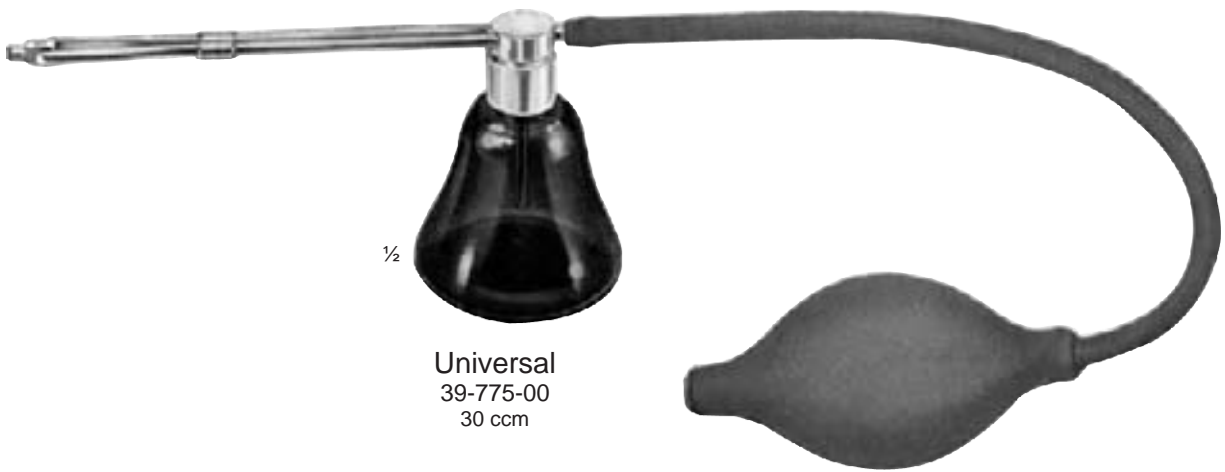
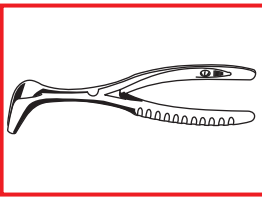

½

Universal
39-775-00
30 ccm

39-775-05
(Rubber Blub)

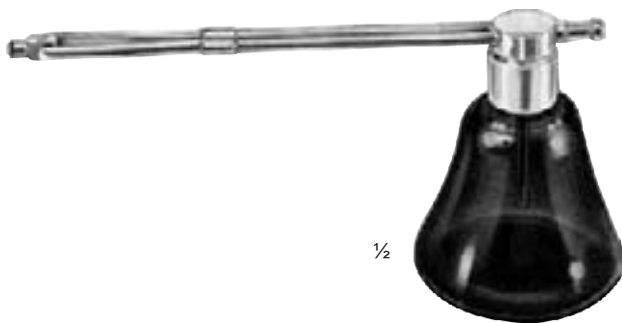

½

Universal
39-775-01
30 ccm



Mallets

Hämmer

Maillets

Martillos

Martelli

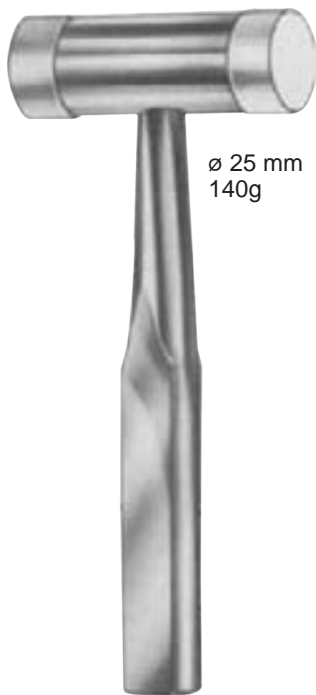

ø 25 mm
140g

39-782-18
18 cm / 7"

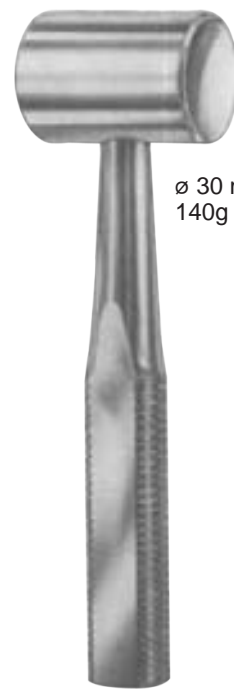

ø 30 mm
140g

39-785-19
19 cm / 7½"