

Falcon[®]

Surgical
Instruments



38

OTOLOGY

OTOLOGIE
OTOLOGÍA
OTOLOGIE
OTOLOGIA



Micro Ear Forceps

Mikro-Ohrzängchen
Micro pinzas auriculares

Micro pinces auriculaires
Micro pinze auricolari

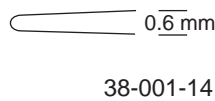
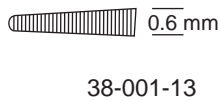
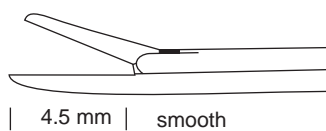
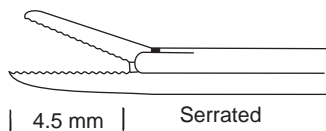
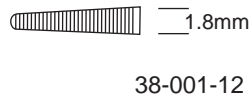
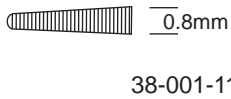
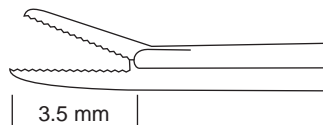
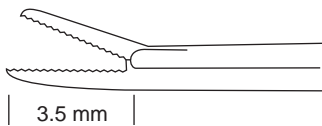
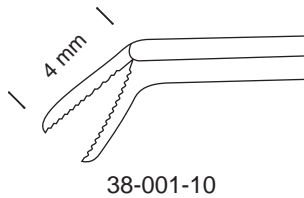
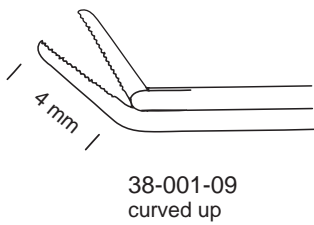
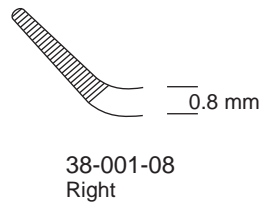
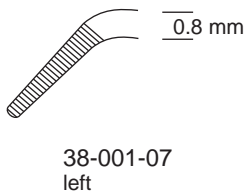
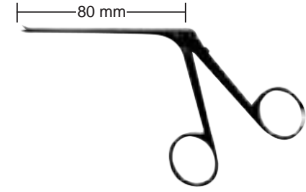
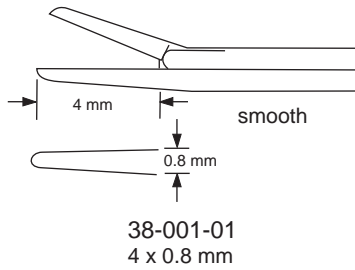
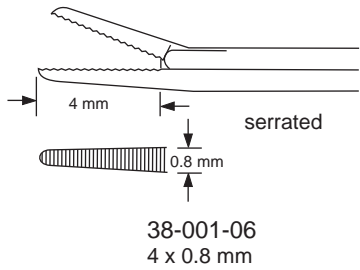
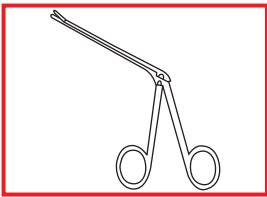

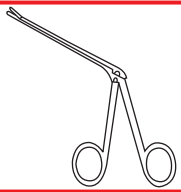

Micro Ear Forceps

Mikro-Ohrzängchen
Micro pinzas auriculares

Micro pinces auriculaires
Micro pinze auricolari

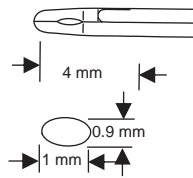
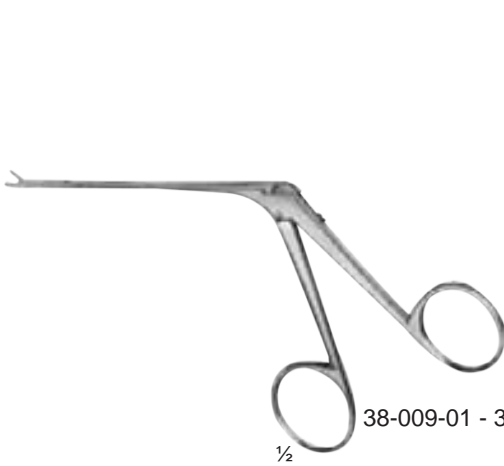
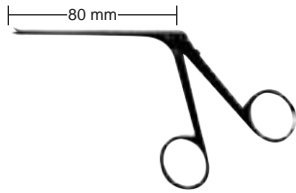

38-009-01
straight

38-009-02
curved up

38-009-03
right

38-009-04
left

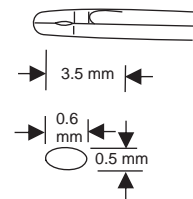
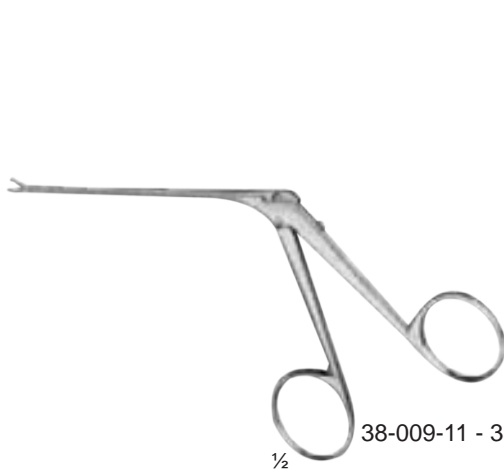

38-009-11
straight

38-009-12
curved up

38-009-13
right

38-009-14
left

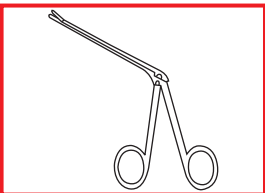

Micro Ear Scissors

Mikro-Ohrscherchen
Micro tijeras auriculares

Micro Ciseaux auriculaires
Micro Forbici auricolari

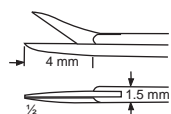
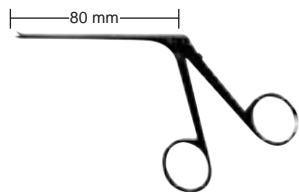

38-015-01
Straight



38-015-02
curved up

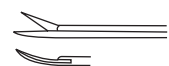

38-015-03
right

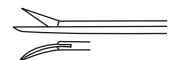

38-015-04
left



Bellucci
38-015-01 - 38-015-04

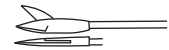
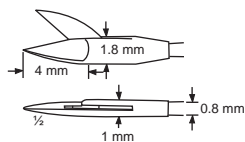

38-015-51
Straight



38-015-52
curved up

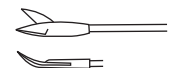

38-015-53
right

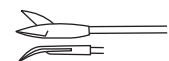

38-015-54
left

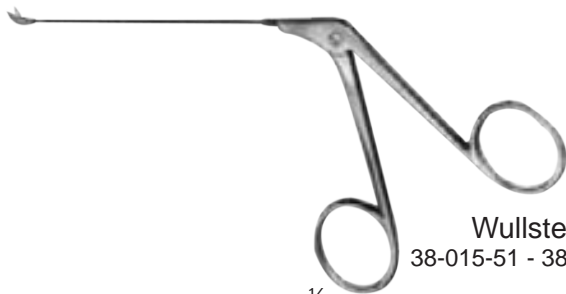

Wullstein
38-015-51 - 38-015-54

Micro Ear Forceps

Mikro-Ohrzängchen
Micro pinzas auriculares

Micro pinces auriculaires
Micro pinze auricolari

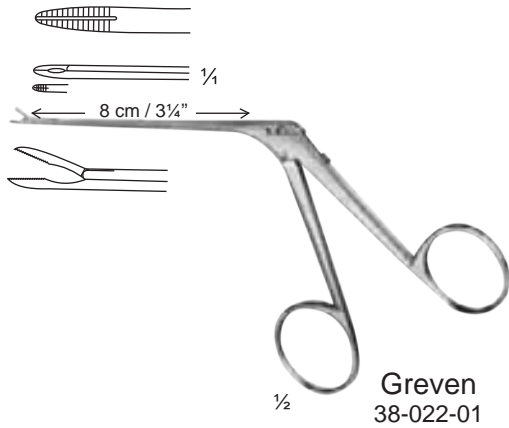
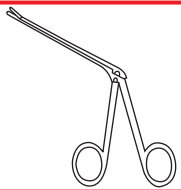

Greven
38-022-01

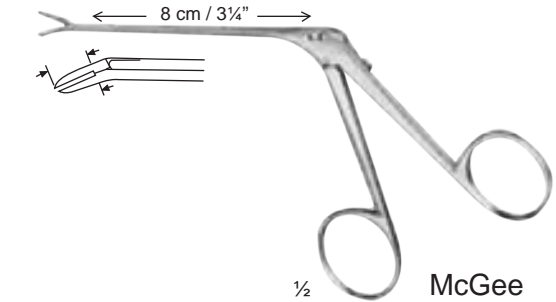
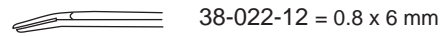
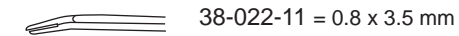

McGee
38-022-11 - 38-022-12

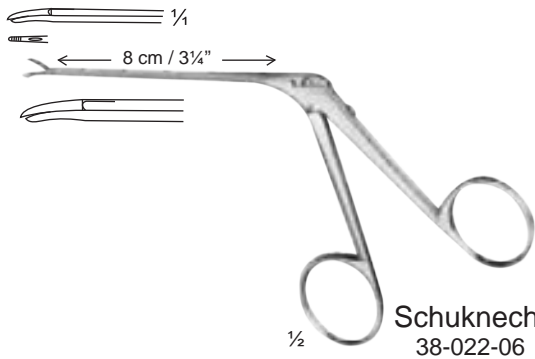

Schuknecht
38-022-06

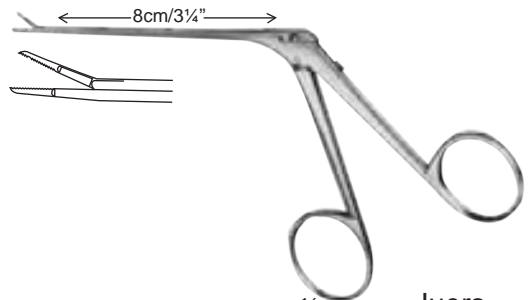
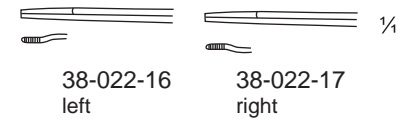

Juers
38-022-16 - 38-022-17

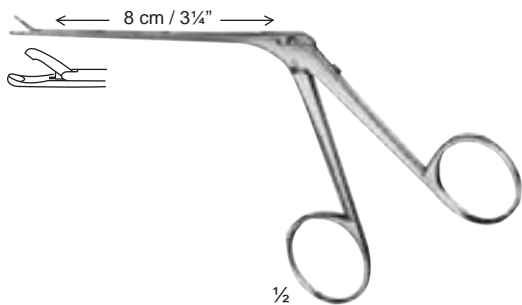

Crura-Nipper
38-024-00

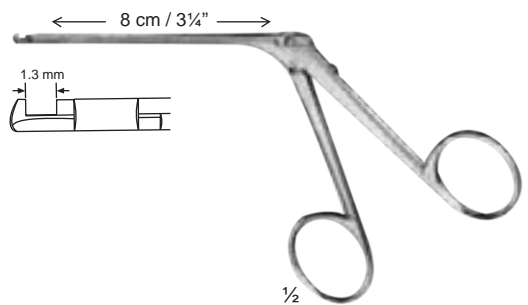

House-Dieter
38-027-01 - 38-027-07

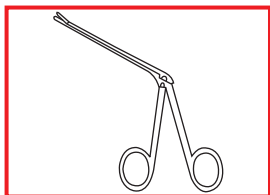

Micro Ear Knives

Mikro-Ohrmesser
Micro cuchillos auriculares

Micro Couteaux auriculaires
Micro Coltelli



1/2

Rosen

38-034-01 - 38-034-07
16 cm / 6 1/4"

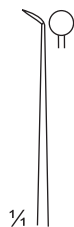

1/4

38-034-01
3 mm



38-034-02
2.8 mm



38-034-03
2.6 mm



38-034-04
2 mm



38-034-05
1.6 mm



38-034-06
1.4 mm



38-034-07
1 mm



3x

1/2

Schuknecht

38-036-01
16 cm / 6 1/4"

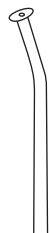

3x

Schuknecht

38-036-02
16 cm / 6 1/4"



3x

Schuknecht

38-036-06
16 cm / 6 1/4"



3x

Wullstein

38-036-11
16 cm / 6 1/4"



3x

Tabb

38-036-16
16 cm / 6 1/4"



3x

Plester

38-036-21
16 cm / 6 1/4"

Micro Ear Hooks, Micro Ear Needles

Mikro-Ohrhäkchen, Mikro-Ohrnadeln
 Micro ganchitos auriculares, Micro agujas auriculares

Micro Crochets auriculaires, Micro Aiguilles auriculaires
 Micro Uncini auricolari, Mirco Aghi auricolari

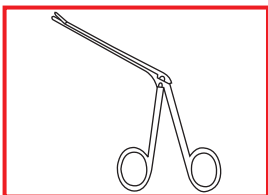

1/2
Barbara
 38-044-01 - 38-044-32
 16 cm / 6 1/4"



Barbara
 38-044-01



Barbara
 38-044-02



Barbara
 38-044-03



Rosen
 38-044-04



25°



45°



90°



mm	Barbara	Shambaugh	Shambaugh	Barbara
0.3	38-044-06	38-044-11	38-044-21	38-044-31
0.6	38-044-07	38-044-12	38-044-22	38-044-32
1.0	38-044-08	38-044-13	38-044-23	
1.2		38-044-14	38-044-24	
1.5		38-044-15	38-044-25	
2.0		38-044-16	38-044-26	
2.5		38-044-17	38-044-27	

Micro Ear Hooks, Micro Ear Needles

Mikro-Ohrhäkchen, Mikro-Ohrnadeln
 Micro ganchitos auriculares, Micro agujas auriculares

Micro Crochets auriculaires, Micro Aiguilles auriculaires
 Micro Uncini auricolari, Mirco Aghi auricolari

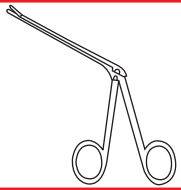

Barbara
38-049-01



Rosen
38-049-06



McGee
38-053-01 = 0.5 mm
38-053-02 = 1 mm



McGee
38-053-11 = 0.5 mm
38-053-12 = 1 mm



1/2

38-049-01 - 38-055-28
15.5 cm / 6"



90°



90°



1/4
25°



25°



45°



45°

0.3mm	38-055-01	38-055-06	38-055-11	38-055-16	38-055-21	38-055-26
0.6mm	38-055-02	38-055-07	38-055-12	38-055-17	38-055-22	38-055-27
1.0mm	38-055-03	38-055-08	38-055-13	38-055-18	38-055-23	38-055-28

Micro Dissectors, Micro Curettes

Mikro-Dissektoren, Mikro-Küretten
 Micro disecadores, Micro cucharillas

Micro Dissecteurs, Micro Curettes
 Micro Dissettori, Micro cucchiari

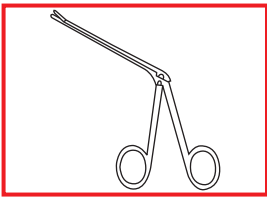

Rosen
 38-064-21 - 38-064-51
 16 cm / 6¼"



38-064-21



38-064-22



38-064-23



38-064-31



38-064-41



38-064-51



Rosen
 19 cm / 7½"



38-067-15
 1.5 mm



38-067-25
 2.5 mm



Plester
 38-069-16
 16 cm / 6¼"



Fisch
 38-072-01 - 38-072-06
 16 cm / 6¼"



R
 38-072-01



L
 38-072-02



R
 38-072-05



L
 38-072-06



House
 38-074-01 - 38-074-04
 16 cm / 6¼"



3.5 mm
 38-074-01



4 mm
 38-074-02



4.5 mm
 38-074-03



5 mm
 38-074-04

Footplate Hand Instruments

Instrumente für die Stapes-Fußplatte
Instrumentos para la platina estapediense

Instruments pour chirurgie de l'étrier
Strumenti per lo stapes

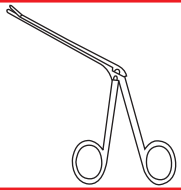

House
38-082-01 = 1.0 / 1.2 mm
38-082-02 = 1.5 / 1.8 mm
15 cm / 6"



House
38-082-03 = 1.0 / 1.2 mm
38-082-04 = 1.5 / 1.8 mm
15 cm / 6"



Shea
38-082-12
1.5 mm
12 cm / 4 3/4"

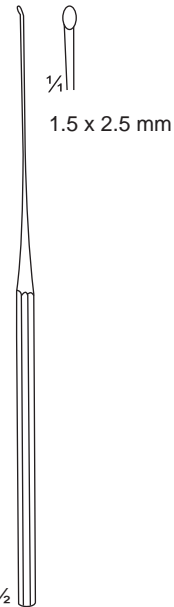

Shea
38-084-16
16 cm / 6 1/4"

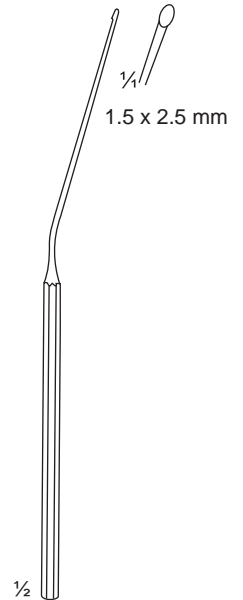

Shea
38-087-16
16 cm / 6 1/4"

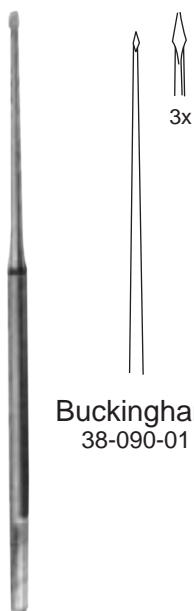

Buckingham
38-090-01

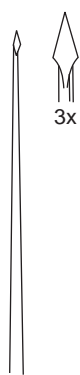

Buckingham
38-090-02

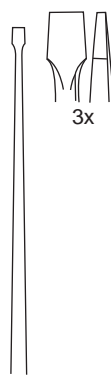

Buckingham
38-090-03

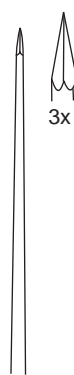

Larkin
38-092-01

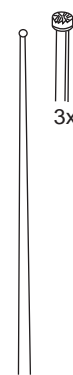

Larkin
38-092-02

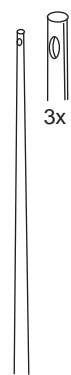

Larkin
38-092-03

38-090-01 - 38-092-03
16 cm / 6 1/4"

Footplate Hand Instruments

Instrumente für die Stapes-Fußplatte
Instrumentos para la platina estapediense

Instruments pour chirurgie de l'étrier
Strumenti per lo stapes

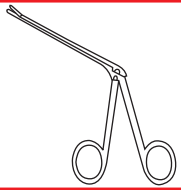

38-100-01
7 cm / 3"



38-100-02
7 cm / 3"



38-100-03
7 cm / 3"



38-100-04
7 cm / 3"



38-100-05
7 cm / 3"



38-100-06
7 cm / 3"



38-100-07
7 cm / 3"



½
38-100-15
19.5 cm / 7¾"

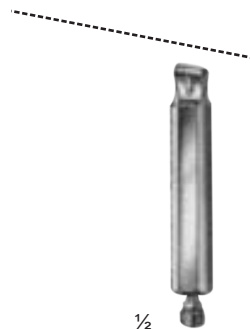

½
Heermann
38-100-10

Ear Specula

Ohrspekula
Especulos auriculares

Spéculums auriculaires
Specoli auricolari

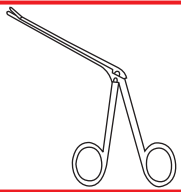

∅ = Inside diameter

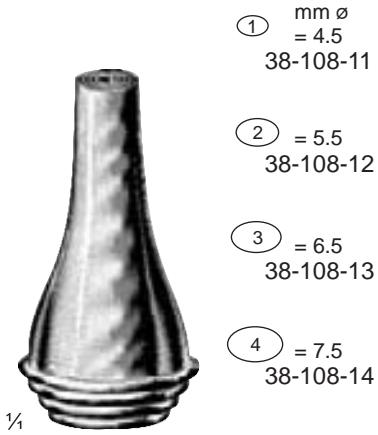

Gruber
for adults
pieces fig.
3 2-4 38-109-03
4 1-4 38-109-04

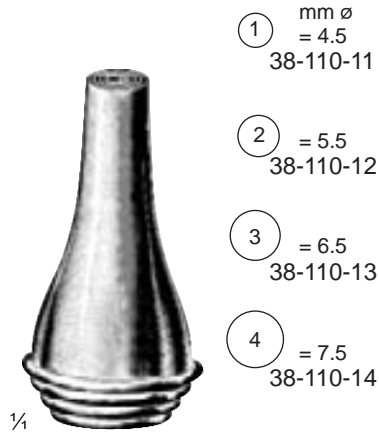

Gruber
for adults
pieces fig.
4 1-4 38-111-04



Zollner
38-115-06
Set 6 Pcs
Alu, Black

- 5.5 x 6.5 mm
38-114-01
- 6.5 x 7.5 mm
38-114-02
- 7.5 x 8.5 mm
38-114-03
- 8.5 x 9.5 mm
38-114-04
- 9.5 x 10.5 mm
38-114-05
- 10.5 x 11.5 mm
38-114-06

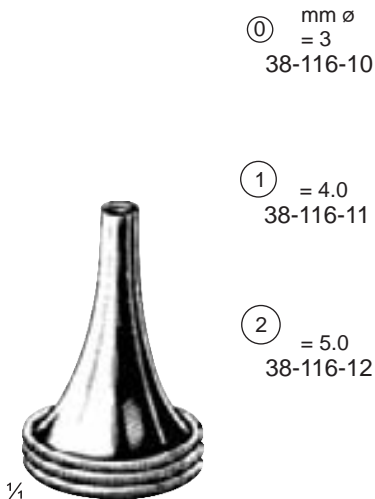

Hartmann
for children
pieces fig.
3 0-2 38-117-03

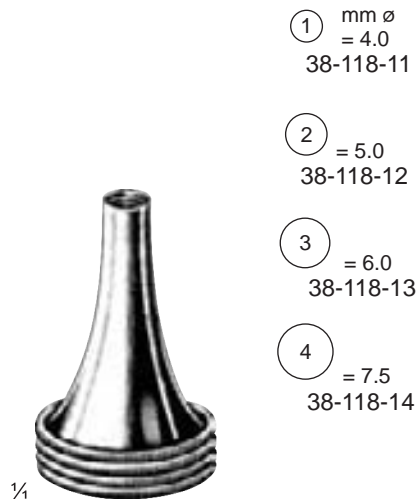

Hartmann
for adults
pieces fig.
3 2-4 38-119-03
4 1-4 38-119-04

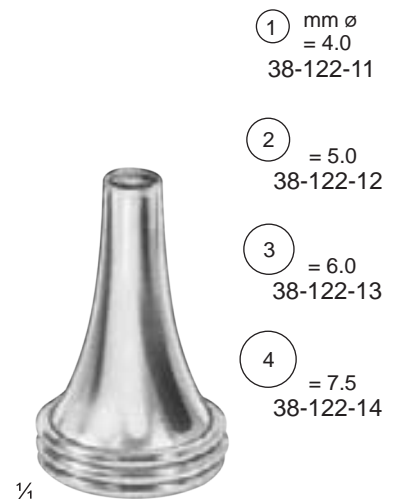

Toynbee
for adults
pieces fig.
3 2-4 38-123-03
4 1-4 38-123-04

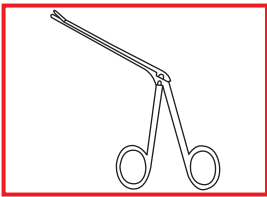

Ear Specula

Ohrspekula
Especulos auriculares

Spéculums auriculaires
Specoli auricolari



mm 2.0 3.0 3.5 4.0 4.5 5.0 5.5 6.5 7.0



Set 1 - 3
38-132-03



Set 00-3
38-134-04

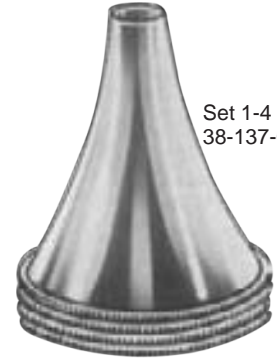

Set 1-4
38-137-04

mm	Politzer	Hartmann	Boucheron
2.0	38-131-01		
3.0	38-131-02	38-133-00	
3.5			38-136-01
4.0	38-131-03	38-133-01	
4.5			38-136-02
5.0	38-131-04	38-133-02	
5.5			38-136-03
6.5			38-136-04
7.0		38-133-03	

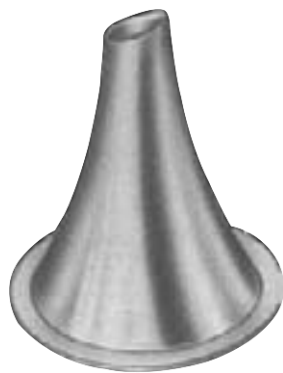

Farrior

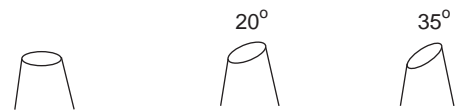

○ 3.3 mm	38-138-33	○ 3.0 x 4.0 mm	38-140-30	38-141-30	38-142-30
○ 4.3 mm	38-138-43	○ 4.0 x 5.0 mm	38-140-40	38-141-40	38-142-40
○ 4.8 mm	38-138-48	○ 4.5 x 5.5 mm	38-140-45	38-141-45	38-142-45
○ 5.3 mm	38-138-53	○ 5.0 x 6.0 mm	38-140-50	38-141-50	38-142-50
○ 5.8 mm	38-138-58	○ 5.5 x 6.5 mm	38-140-55	38-141-55	38-142-55
○ 6.3 mm	38-138-63	○ 6.0 x 7.0 mm	38-140-60	38-141-60	38-142-60
○ 6.7 mm	38-138-67	○ 6.5 x 7.5 mm	38-140-65	38-141-65	38-142-65
○ 7.2 mm	38-138-72	○ 7.0 x 8.0 mm	38-140-70	38-141-70	38-142-70
○ 7.7 mm	38-138-77	○ 7.5 x 8.5 mm	38-140-75	38-141-75	38-142-75

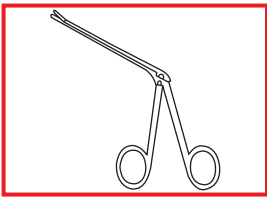

Ear Specula

Ohrspekula
Especulos auriculares

Spéculums auriculaires
Specoli auricolari

1

6.5



38-150-11

2

7



38-150-12

3

8 mm ø



38-150-13

1

6



38-153-11

2

7.5



38-153-12

3

8.2



38-153-13

4

10 mm ø



38-153-14

38-153-04 = complete set

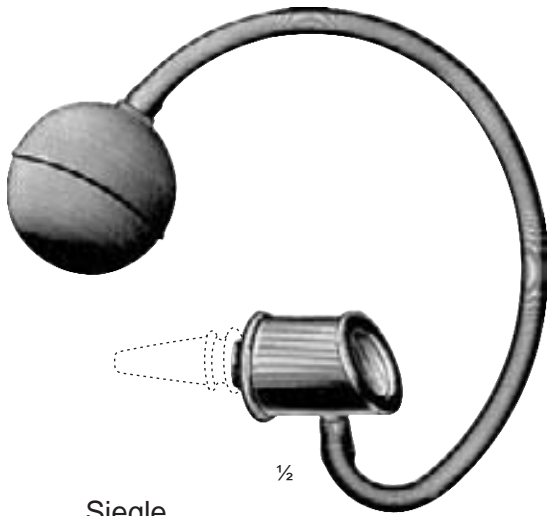

Siegle
38-151-03

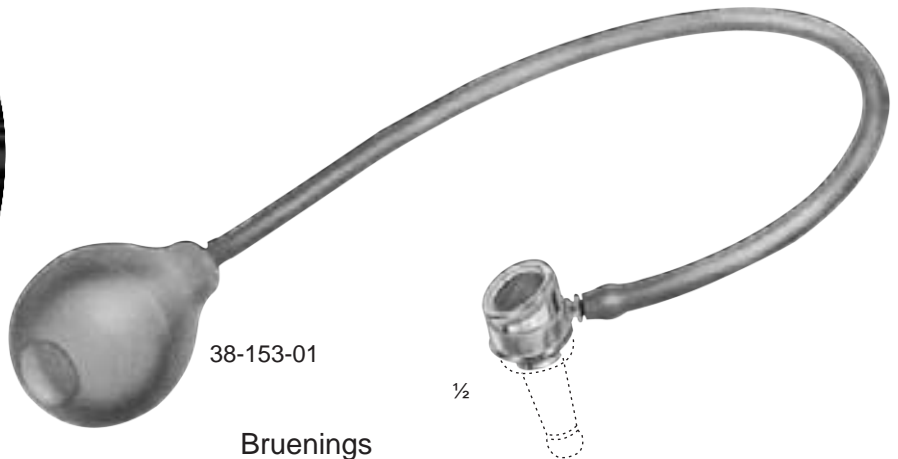

Bruenings
38-154-04 = complete set

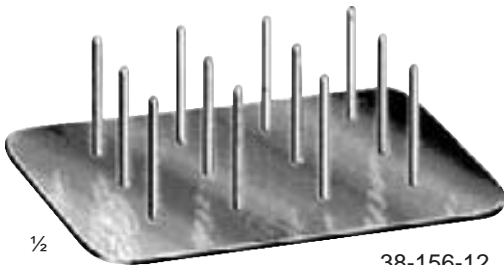

38-156-12
38-151-03

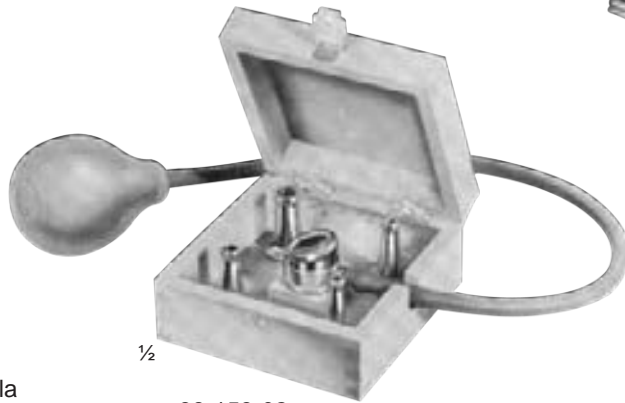

38-153-02



Richnau Holmgren
ø 2.0 mm 38-159-02
ø 4.0 mm 38-159-04
ø 6.0 mm 38-159-06

- 38-156-12 - Metal Supports for 12 specula
- 38-151-03 - Pneumatic Otoscope with 3 ear specula and rubber tube with bulb
- 38-151-04 - ditto, with 4 specula and suction head for massage, complete with rubber tube and bulb in wooden case
- 38-153-01 - Rubber Bulb only
- 38-153-02 - Wooden Case only
- 38-153-04 - Set of 4 Ear Specula only
- 38-154-00 - Complete Set in Wooden case

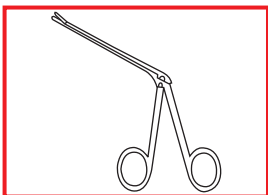

Tuning Forks

Stimmgabeln
Diapasones

Diapasons
Diapason

ALU



Hartmann



Lucae



Hartmann-French

C ₂	16			38-192-07
C ₁	32			38-194-08
C	64			38-196-09
C	128	38-166-10	38-178-10	38-199-10
C ₁	256	38-166-11	38-180-11	38-201-11
C ₂	512	38-168-12	38-182-12	
C ₃	1024	38-170-13	38-184-13	
C ₄	2048	38-172-14	38-186-14	
C ₅	4096	38-174-15	38-188-15	

38-211-05 38-168-12
 38-170-13
 38-172-14
 38-199-10
 38-201-11

38-211-06 38-168-12
 38-170-13
 38-172-14
 38-196-09
 38-199-10
 38-201-11

38-211-08 38-168-12
 38-170-13
 38-172-14
 38-174-15
 38-196-09
 38-199-10
 38-201-11



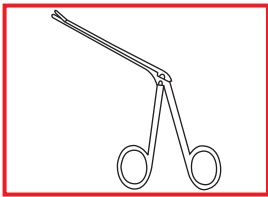

Tuning Forks

Stimmgabeln
Diapasones

Diapasons
Diapason

ALU



c 64

38-220-01

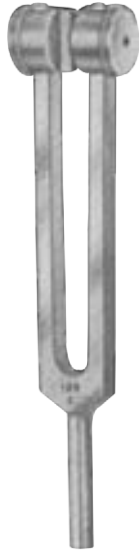

c 128

38-220-02



c 256

38-220-03



c 512

38-220-04



c 1024

38-220-05



c 2048

38-220-06



c 4096

38-220-07



38-221-01 = 38-220-02
38-220-03
38-220-04
38-220-05
38-220-06

Ear Catheters, Noise Apparatus

Ohrkatheter, Lärmapparat
Sondas auriculares, Ensordecedor

Sondes auriculaires, Assourdisseur
Sonde auricolari, Assordatore

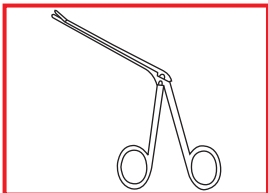

- 38-229-00
- 38-229-01
- 38-229-02
- 38-229-03
- 38-229-04
- 38-229-05



$\frac{1}{2}$
Hartmann
38-229-00 - 38-229-05
14 cm / 5½"

- 38-231-01
- 38-231-02
- 38-231-03
- 38-231-04
- 38-231-05



$\frac{1}{2}$
Itard
38-231-01 - 38-231-05

- Fig. 1
- 2
- 3
- 4
- 5



$\frac{1}{2}$
Troeltsch
38-233-01
38-233-02
38-233-03
38-233-04
38-233-05



$\frac{1}{2}$
Barany
38-236-00



$\frac{1}{2}$
38-236-01
Olive Ear Piece Only



$\frac{1}{2}$
Barany
38-238-00



$\frac{1}{2}$
38-238-01
Rubber only

Ear Polypus Forceps, Polypus Snares

Ohrpolypenzangen, Polypenschnürer
 Pinzas para pólipos auriculares, Polipótomos

Pinces pour polypes auriculaires, Serre-noeuds
 Pinze per polipi auricolari, Serranodi

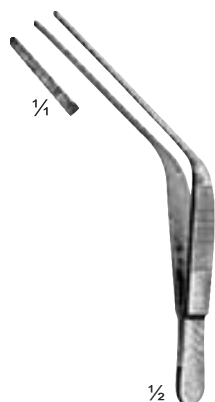
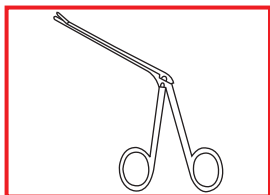

Troeltsch (Wilde)
 38-245-11
 11 cm / 4½"

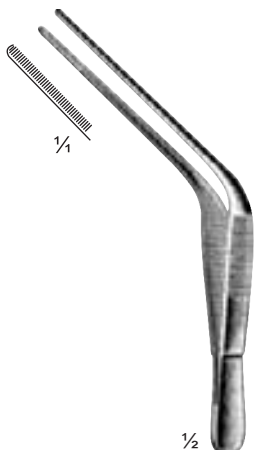

Troeltsch (Wilde)
 38-247-12
 12 cm / 4¾"



Troeltsch (Wilde)
 38-249-13
 13 cm / 5"



Lucae
 38-251-14
 14 cm / 5½"



Jansen
 38-253-16 = 16 cm / 6¼"
 38-253-20 = 20 cm / 8"



Krause
 38-255-16
 16 cm / 6¼"



Krause-Voss
 38-257-16
 16 cm / 6¼"



Lange-Wilde
 38-259-16
 16 cm / 6¼"

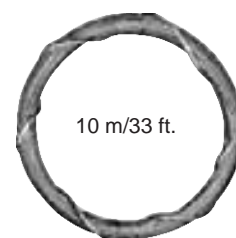

10 m/33 ft.

38-258-30
 0.3mm ø
 38-258-40
 0.4mm ø



38-263-20 0.2 mm ø
 38-263-30 0.3 mm ø
 Pack. of 12 pcs.

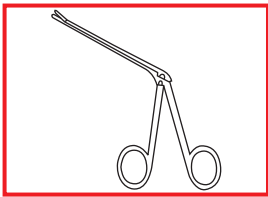

Ear Forceps

Ohrpinzetten
Pinzas auriculares

Pinces auriculaires
Pinze auricolari

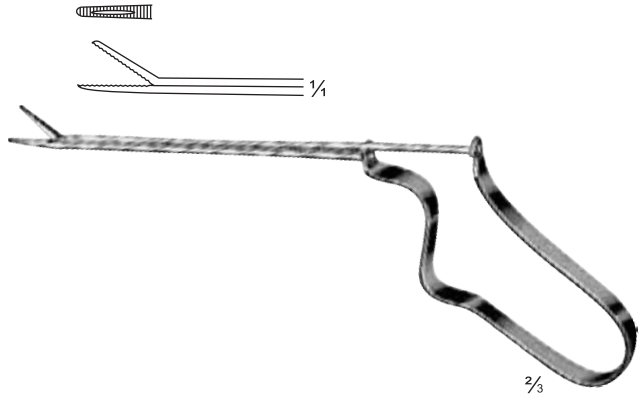

Buck
38-270-11
11 cm / 4 1/2"

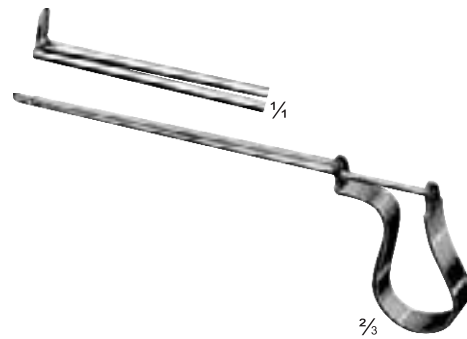

Quire
38-272-10
10 cm / 4"

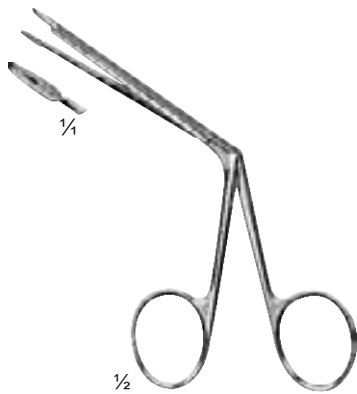

Littauer
38-275-12
12 cm / 4 3/4"

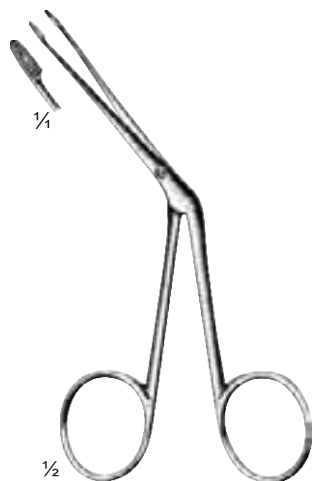

Hartmann
38-277-12
12 cm / 4 3/4"
fine pattern

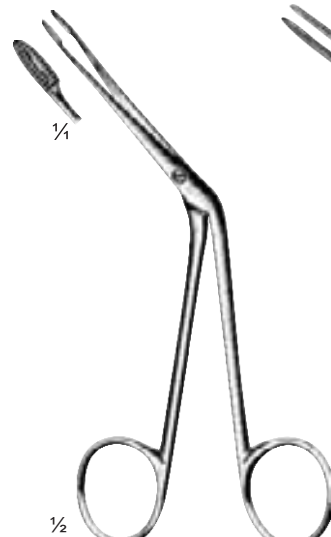

Hartmann
38-279-14
14 cm / 5 1/2"
standard pattern



Tilley
38-282-14
14 cm / 5 1/2"

Ear Forceps

Ohrpinzetten Pincas auriculares
 Pinzas auriculares Pinze auricolari

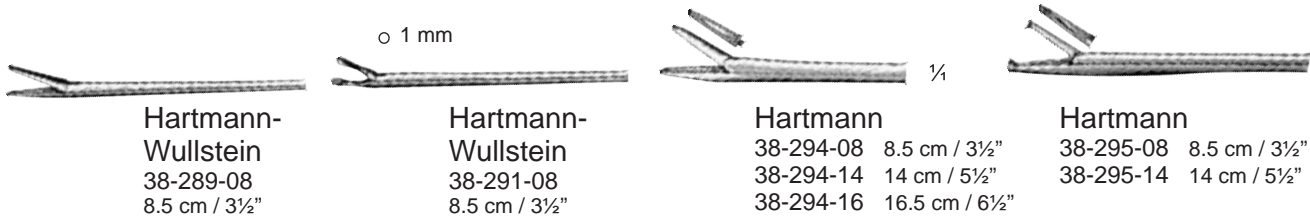
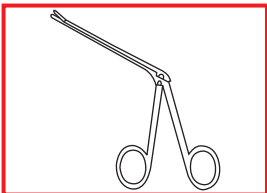

Hartmann-Wullstein
 38-289-08
 8.5 cm / 3 1/2"

o 1 mm

Hartmann-Wullstein
 38-291-08
 8.5 cm / 3 1/2"

Hartmann
 38-294-08 8.5 cm / 3 1/2"
 38-294-14 14 cm / 5 1/2"
 38-294-16 16.5 cm / 6 1/2"

1/4

Hartmann
 38-295-08 8.5 cm / 3 1/2"
 38-295-14 14 cm / 5 1/2"



Hartmann-Noyes
 38-298-09 8.5 cm / 3 1/2"

Hartmann-Noyes
 38-299-09 8.5 cm / 3 1/2"

Hartmann-Weingartner
 38-300-08 8.5 cm / 3 1/2"

Hartmann
 38-302-08
 8.5 cm / 3 1/2"

- o 2 mm
- o 2.5 mm
- o 3 mm



Hartmann
 38-304-81 = 2 mm ø
 38-304-82 = 2.5 mm ø
 38-304-83 = 3 mm ø
 8.5 cm / 3 1/2"

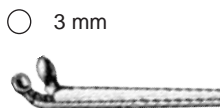

o 3 mm

Hartmann
 38-307-08
 8.5 cm / 3 1/2"



Struempel
 38-310-08
 8.5 cm / 3 1/2"

1/4



Hartmann
 38-312-08
 8.5 cm / 3 1/2"

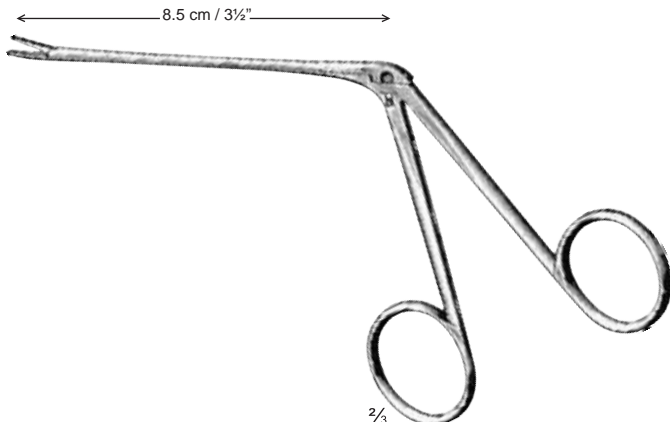

8.5 cm / 3 1/2"

2/3

38-289-08 - 38-316-08



Hartmann
 38-314-08
 8.5 cm / 3 1/2"

1/4

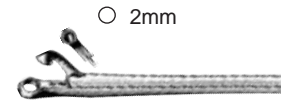

o 2mm

Hartmann-Hoffmann
 38-316-08
 8.5 cm / 3 1/2"

Punches

Stanzen
Pinzas osteótomas

Pinces ostéotomes
Pinze osteotomi

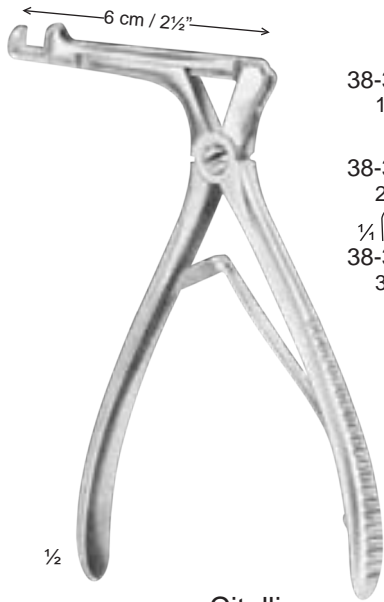
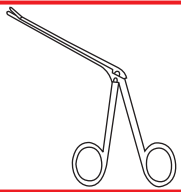

- ∩
38-325-17
1 mm
- ∩
38-326-17
2 mm
- ¼ ∩
38-327-17
3 mm

½

Citelli
38-325-17 - 38-327-17

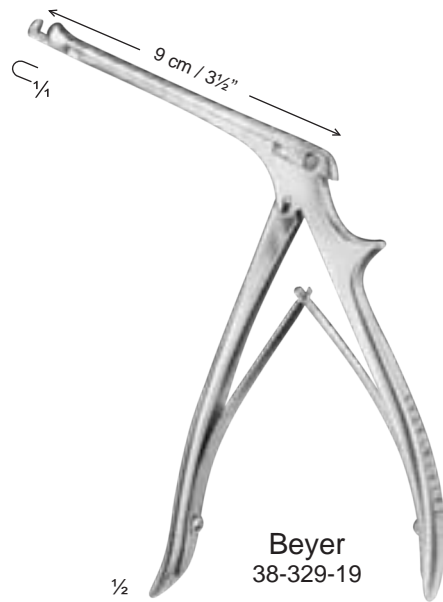

½

Beyer
38-329-19



ultra delicate,

½

Beyer
38-332-14

Ear Currettes

Ohrküretten Currettes auriculaires
 Curretas auriculares Curette auricolari

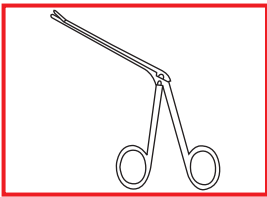

blunt

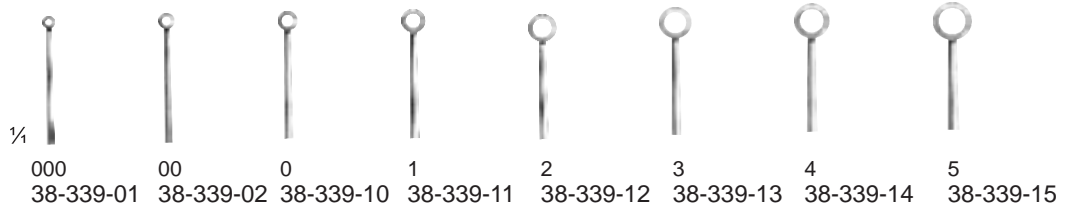

sharp



1/2

Buck

38-339-01 - 38-340-15
 16.5 cm / 6 1/2"



blunt

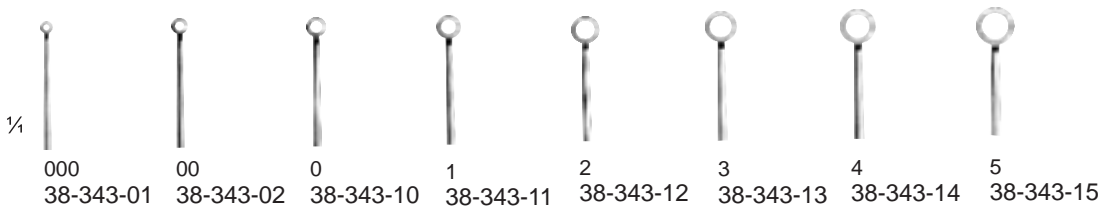

sharp

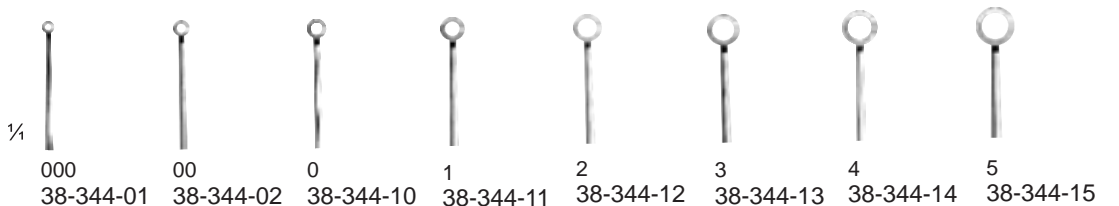

1/2

Buck

38-343-01 - 38-344-15
 16.5 cm / 6 1/2"

Ear Cures, Ear Scoop

Ohrküretten, Ohrlöffel
Curetas auriculares, Cucharilla auricular

Curettes auriculaires, Curette auriculaire
Curette auricolari, Curetta auricolare

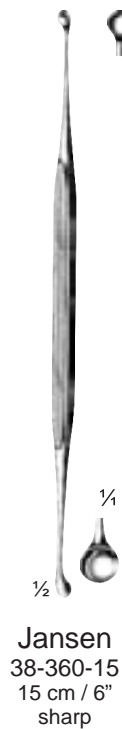
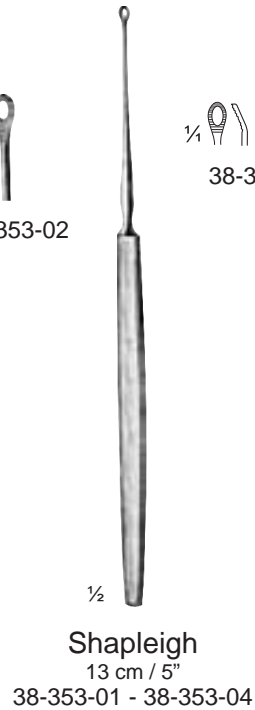
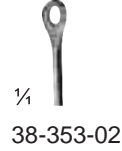
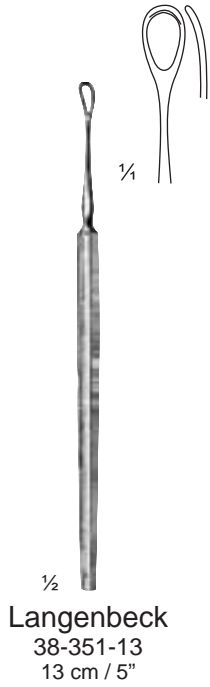
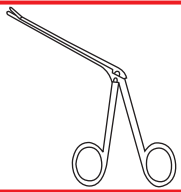

Loops, Hooklets

Schlingen, Häkchen
Asas, Ganchitos

Anses, Crochets
Anse, Uncini

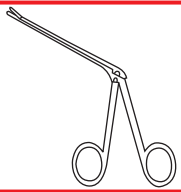

Moldenhauer
38-369-16
16.5 cm / 6½"



Zaufal
38-371-16
16 cm / 6¼"



Hartmann
38-374-16
16 cm / 6¼"

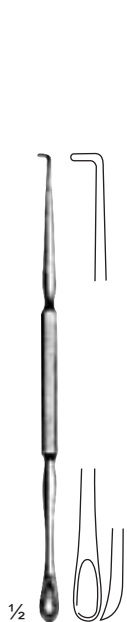

Gross
38-377-12
12 cm / 4¾"
blunt

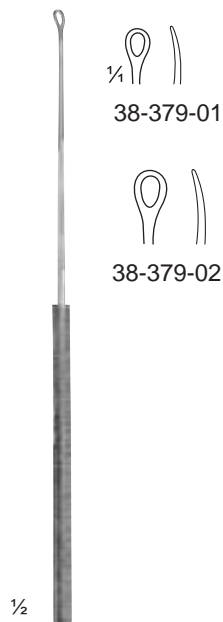

38-379-01 - 38-379-02
16 cm / 6¼"

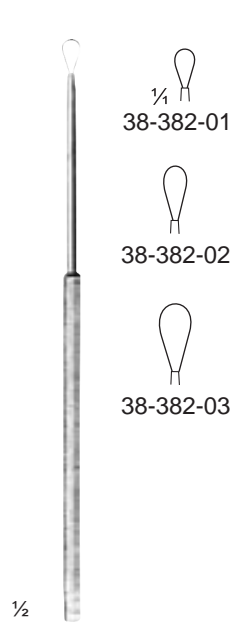

Billeau
38-382-01 - 38-382-03
16.5 cm / 6½"



Snellen
38-384-01 - 38-384-02
16.5 cm / 6½"

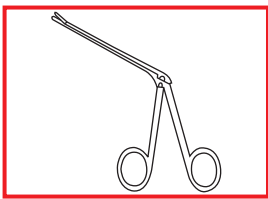

Hooklets

Häkchen
Ganchitos

Crochets
Uncini

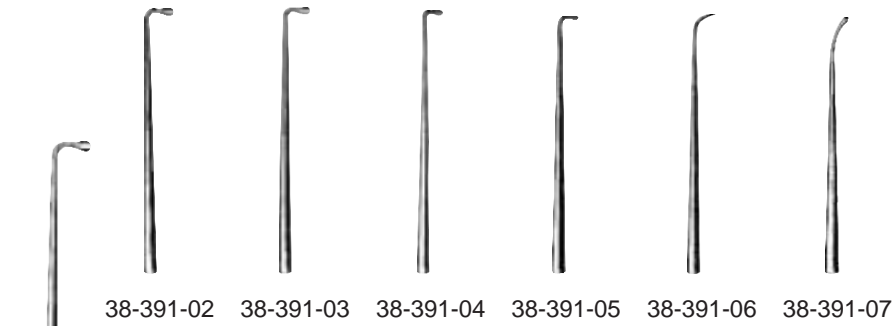

Wagener
38-391-01 - 38-391-07
14 cm / 5½"

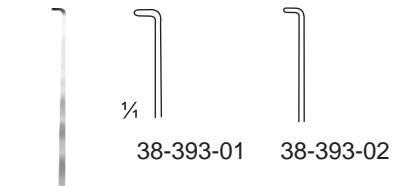

Day
38-393-01 - 38-393-02
16 cm / 6¼"

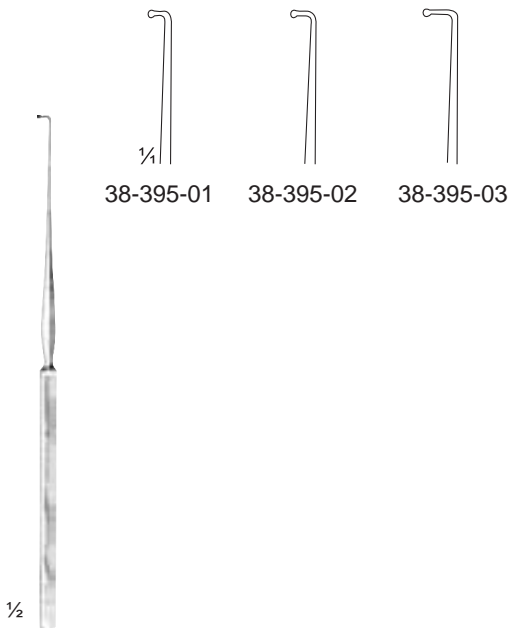

Lucae
38-395-01 - 38-395-03
14 cm / 5½"



Allport
38-397-16
16 cm / 6¼"

Paracentesis Needles, Knives

Parazentesenadeln, Messer
Agujas para paracentesis, Cuchillos

Aiguilles à paracentèse, Bistouris
Aghi per paracentesi, Bisturi

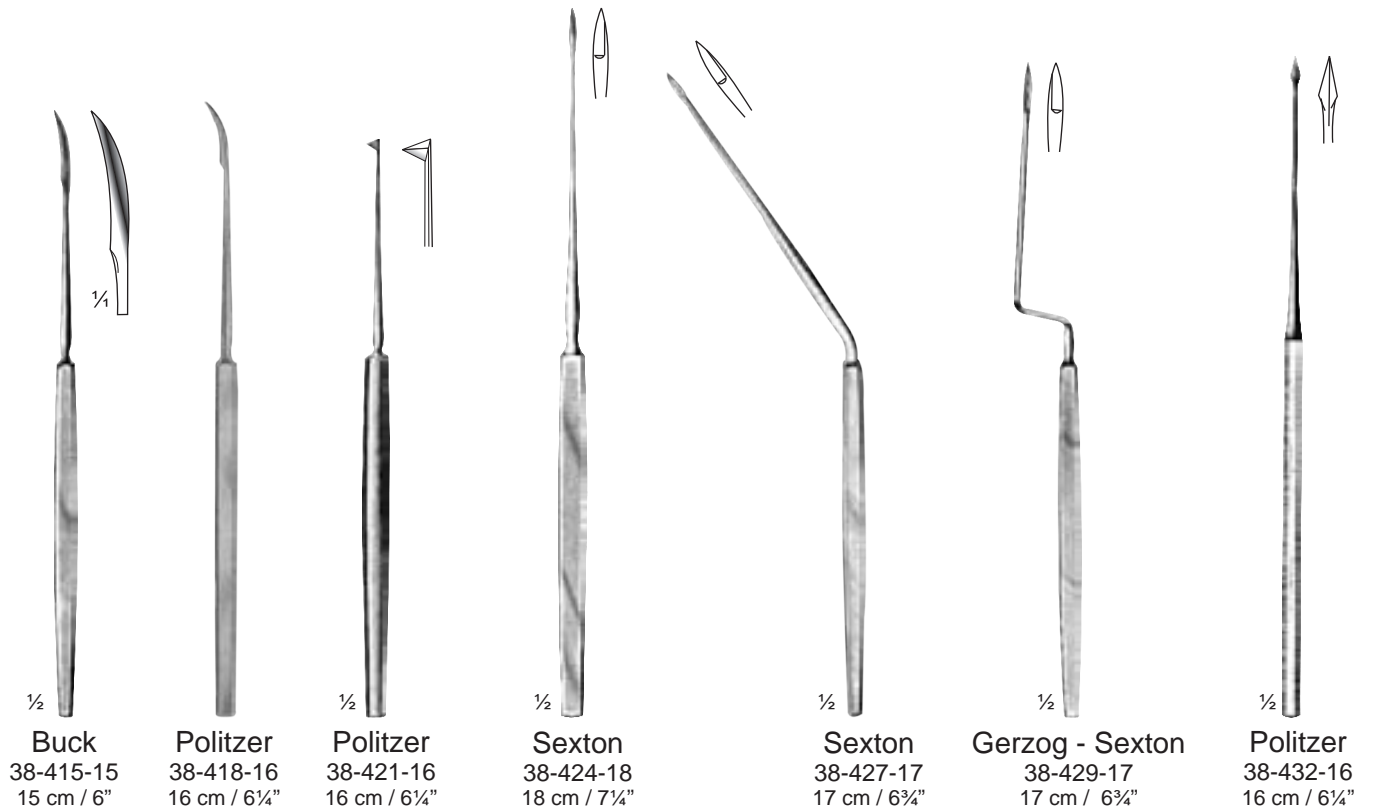
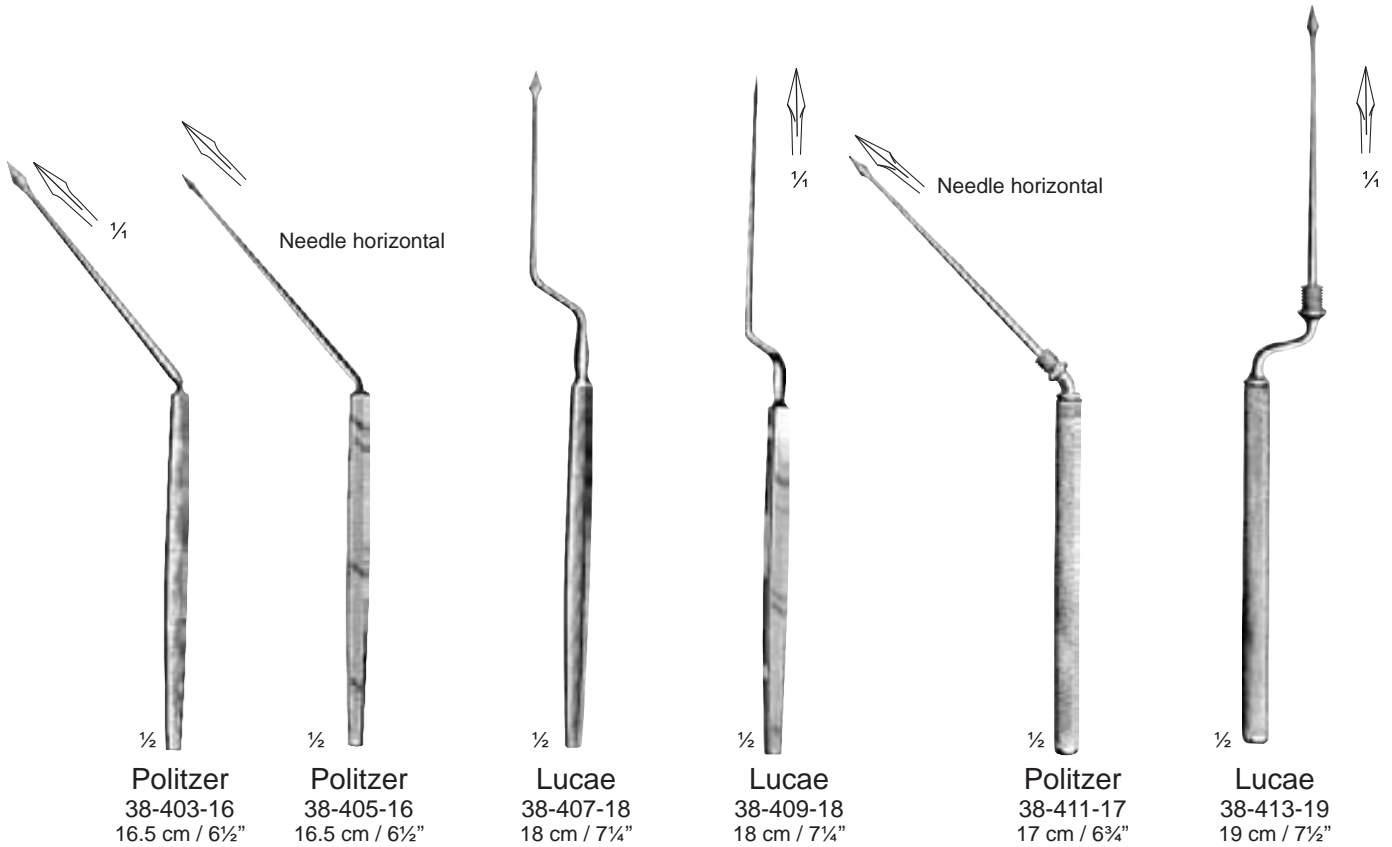
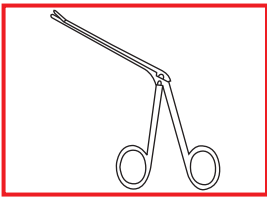

Curettes, Elevators, Raspatories

Küretten, Elevatorien, Raspatorien
Curetas, Elevadores, Legras

Curettes, Elévateurs, Rugines
Curette, Elevatori, Periostotomi

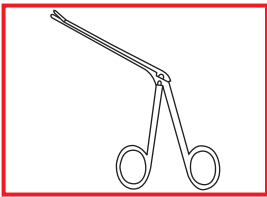

- 0
38-439-10
- 00
38-439-20
- 000
38-439-30
- 0000
38-439-40
- 00000
38-439-50

1/2

Lempert
38-439-10 - 38-439-50
17.5 cm / 7"



- 2MM
38-442-02
- 3MM
38-442-03
- 4 mm
38-442-04
- 5 mm
38-442-05

Lempert
38-442-02 - 38-442-05
17 cm / 6 3/4"



Shambaugh-Derlacki
38-445-16
16.5 cm / 6 1/2"

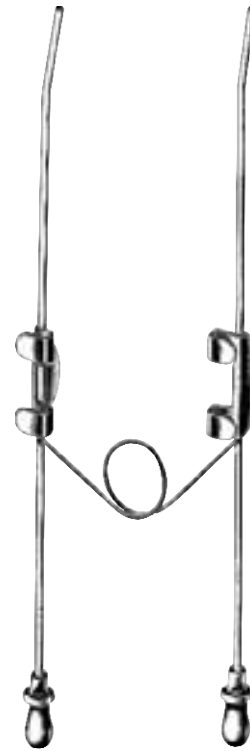

Shambaugh
38-447-19
19 cm / 7 1/2"
left tube 2.0 mm ø
right tube 2.5 mm ø

Shambaugh
38-449-19
19 cm / 7 1/4"
right tube 2.0 mm ø
left tube 2.5 mm ø



- 1/4
38-452-16
2 mm
- 38-453-16
2 mm
- 38-455-16
3 mm

1/2

Lempert
38-452-16 - 38-455-16
19 cm / 7 1/2"



- 38-458-01
2.2 mm
- 38-458-02
3.2 mm

Wullstein
38-458-01 - 38-458-02
16 cm / 6 1/4"



1/2

Lempert
38-461-20
20.5 cm / 5 1/4"



1/2

Lempert
38-463-18
18 cm / 7 1/4"

Air Bag, Powder Blower

Luftdusche, Pulverbläser
Insufladores, Lanzapolvo

Insufflateurs, Lance-Poudre
Insuffiatori, Insoffiatori per polvere

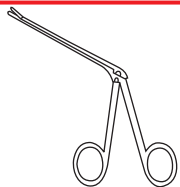

38-470-03



38-470-04
4 mm ø



38-470-15
15 mm ø



38-470-17
17 mm ø



38-470-22
22 mm ø



38-470-50

Politzer

38-470-00 - 38-470-01



38-472-08
8 cm / 3 1/8"

1/2



38-472-11
11 cm / 4 3/8"

1/2



38-472-13
13 cm / 5 1/8"

1/2

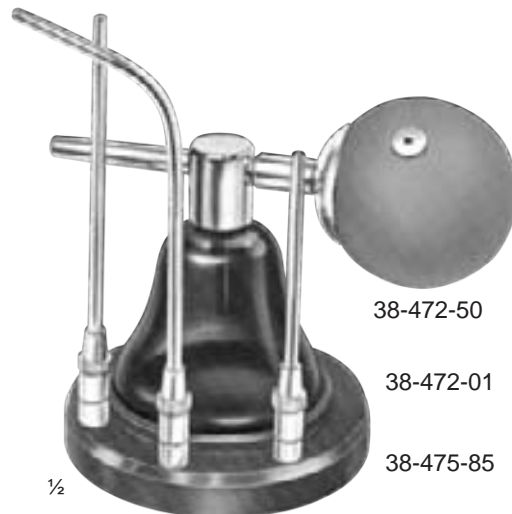

38-472-50

38-472-01

38-475-85

1/2

Kabierske

38-472-00 - 38-475-85
30 cm

- 38-470-00 - Politzer air bag. equipped with three nasal tips No. 38-470-15, 38-470-17, 38-470-22
- 38-470-01 - same as 38-470-00, but with an additional ear tip No. 38-470-04
- 38-470-03 - Politzer connecting nozzle
- 38-470-04 - Politzer ear tip 4mmø
- 38-470-15 - Politzer nasal tip 15mmø
- 38-470-17 - Politzer nasal tip 17mmø
- 38-470-22 - Politzer nasal tip 22mmø
- 38-470-50 - Politzer rubber bulb with metal base plate

- 38-472-00 - Kabierske Powder blower complete, with three different cannulas for nose, throat and larynx
- 38-472-01 - Kabierske spare bottle, 30 cc
- 38-472-08 - Kabierske cannula, straight, 8 cm
- 38-472-11 - Kabierske cannula, straight, 11 cm
- 38-472-13 - Kabierske cannula, curved, 13 cm
- 38-472-50 - Kabierske valve rubber bulb
- 38-475-00 - Kabierske powder blower with a metal base
- 38-475-85 - Metal base only

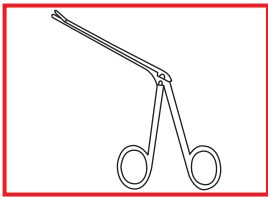

Ear Syringes

Ohrspritzen
Jeringas auriculares

Seringues auriculaires
Siringhe auricolari



38-482-01



38-482-02



Aural Syringe

50 ml = 20z	complete	100 ml = 40z
38-482-05		38-482-10
75 ml = 30z		150 ml = 60z
38-482-07		38-482-15



38-482-03



38-485-01

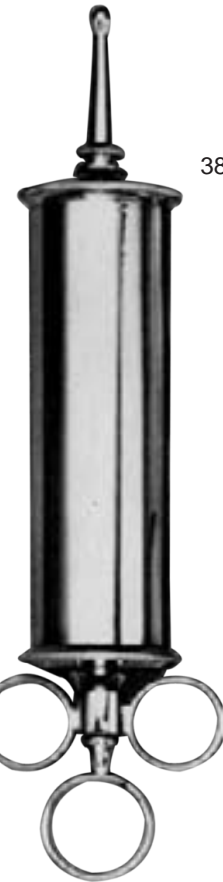

Aural Syringe

38-485-05	50 ml = 20z
38-485-10	100 ml = 40z
38-485-15	150 ml = 60z

38-485-01 = Spare Nozzle, Plain
38-485-02 = Spare Nozzle, Bulbous

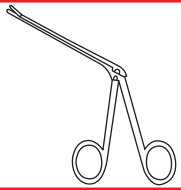

Suction Tubes

Saugrohre
Tubos de aspiración

Canules d'aspiration
Cannule per aspirazione



Zöllner
38-496-00

∅ 0.5 mm = 38-496-05
∅ 0.7 mm = 38-496-07



Baron (Schuknecht)

1.0 mm x 75 mm = 38-496-10
1.5 mm x 75 mm = 38-496-15
2.0 mm x 75 mm = 38-496-20



House
0.9 + 0.7 mm = 38-498-09
1.2 + 0.9 mm = 38-498-12
1.5 + 1.2 mm = 38-498-15
1.8 + 1.8 mm = 38-498-18
2.5 + 2.0 mm = 38-498-25
3.0 + 2.0 mm = 38-498-30
4.5 + 2.0 mm = 38-498-45



Wullstein
38-504-00

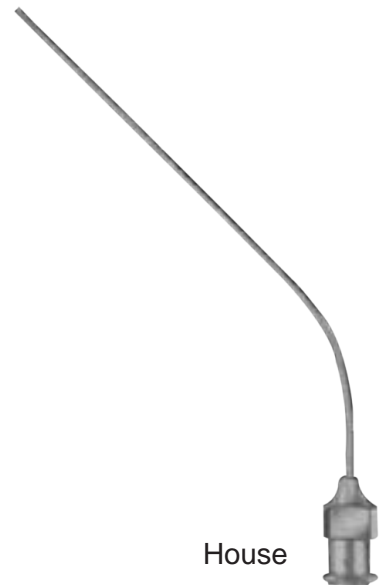

House

0.6 mm = 38-504-06
0.8 mm = 38-504-08
1.0 mm = 38-504-10
1.2 mm = 38-504-12
1.5 mm = 38-504-15
1.8 mm = 38-504-18
2.0 mm = 38-504-20
2.2 mm = 38-504-22
2.5 mm = 38-504-25
3.0 mm = 38-504-30

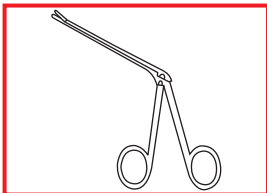

Mallets

Hämmer
Martillos

Maillets
Martelli



Cottle
38-512-24
19 cm / 7½"
240g



27 mm
140g

Hajek
38-515-22
22 cm / 8¾"