

D14

Orthodontics / Ortodoncja



Smart Slide I

Self-ligating bracket system / Zamki samoligaturujące

Smart slide self Ligating are passive Self Ligating brackets system. The easy sliding door make the ligating much easier. To change one set of archwires can take less than one minute and passive mechanical design can provide the lowest friction. Free slide SL brackets make the orthodontic treatment easy and affective.



Single patient kits, 20 pieces / Zestawy dla 1 pacjenta, 20 sztuk.

Type / Typ	Hook / Haczyk	Roth / Rotha
		Slot .022"
5 x 5	on 3 / na 3	DO.0019.01

Clever M

Self-ligating bracket system / Zamki samoligaturujące

It's made of hard 17-4 stainless steel metal, MIM advanced technology. Newest aesthetic design metal brackets, with Interactive Self-Ligating Clip, Contoured appearance for maximum comfort!

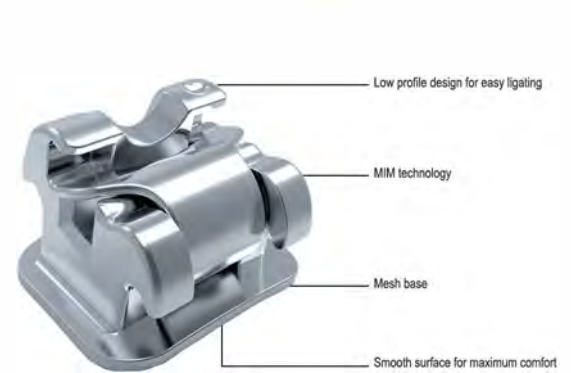

Single patient kits, 20 pieces / Zestawy dla 1 pacjenta, 20 sztuk.

Type / Typ	Hook / Haczyk	Roth / Rotha
		Slot .022"
5 x 5	on 3 / na 3	DO.0018.01

Smart Slide II

Self-ligating bracket system / Zamki samoligaturujące

Smart slide II self Ligating are passive Self Ligating brackets system. The easy sliding door make the ligating much easier. To change one set of archwires can take less than one minute and passive mechanical design can provide the lowest friction. Free slide SL brackets make the orthodontic treatment easy and affective.



2nd molar
na drugi trzonowiec

1st molar
na pierwszy trzonowiec



1 x Upper left / Góra lewa
1 x Upper right / Góra prawa
1 x Lower left / Dół lewa
1 x Lower right / Dół prawa

1 x Upper left / Góra lewa
1 x Upper right / Góra prawa
1 x Lower left / Dół lewa
1 x Lower right / Dół prawa

Roth Series

Torque:-7° Tip:0° 15	Torque:-7° Tip:0° 14	Torque:-2° Tip:8° 13	Torque:+8° Tip:8° 12	Torque:+12° Tip:4° 11	Torque:+12° Tip:4° 22	Torque:+8° Tip:8° 22	Torque:-2° Tip:8° 24	Torque:-7° Tip:0° 24	Torque:-7° Tip:0° 25
45	44	43	41	41	41	32	33	33	33
Torque:-22° Tip:0°	Torque:-17° Tip:0°	Torque:-11° Tip:3°	Torque:-2° Tip:0°	Torque:-2° Tip:0°	Torque:-2° Tip:0°	Torque:-2° Tip:0°	Torque:-11° Tip:3°	Torque:-17° Tip:0°	Torque:-22° Tip:0°

MBT Series

Torque:-11° Tip:2° 15	Torque:-11° Tip:2° 14	Torque:+7° Tip:5° 13	Torque:+6° Tip:9° 12	Torque:+15° Tip:5° 11	Torque:+15° Tip:5° 22	Torque:+6° Tip:9° 22	Torque:+7° Tip:5° 24	Torque:-11° Tip:2° 24	Torque:-11° Tip:2° 25
45	44	43	41	41	41	22	33	34	35
Torque:-17° Tip:4°	Torque:-12° Tip:4°	Torque:+7° Tip:5°	Torque:-3° Tip:2°	Torque:-3° Tip:2°	Torque:-3° Tip:2°	Torque:-3° Tip:2°	Torque:+7° Tip:5°	Torque:-12° Tip:4°	Torque:-17° Tip:4°

Type / Typ	Hook / Haczyk	Roth / Rotha	MBT / MBT
		Slot .022"	Slot .022"
7 x 7	on 3,4,5 / na 3,4,5	DO.0029.03	DO.0069.03

DISGUISE

Lingual bracket system / Zamki lingwalne

Lingual brackets are our second generation invisible lingual orthodontic treatment. Ling-2 system is made with CNC technology and hard stainless steel metal. Ling-2 brackets are most effective Lingual brackets system in the market and need professional skill to operate.

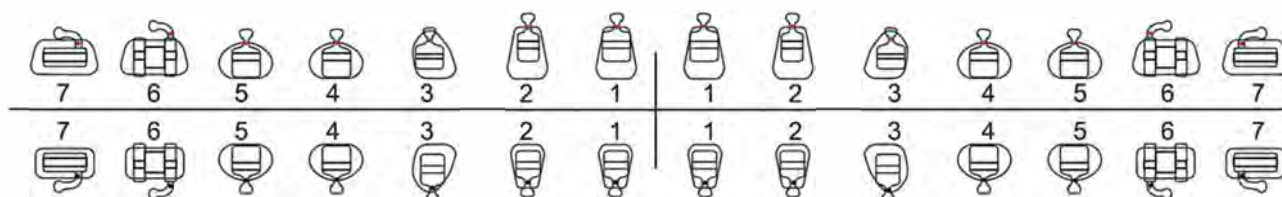

Single patient kits, 28 pieces / Zestawy dla 1 pacjenta, 28 sztuk.

Type / Typ	Hook / Haczyk	Edgewise	
		Slot .018"	Slot .022"
7 x 7	X	DO.1808.00	DO.1818.00

Diamond series

Two-piece Casted Bracket system, 80 gauge foil mesh bonding base
Zamki z dwóch kawałków metalu, posiadają podstawę z siateczką, która zapewni maksymalną siłę wiązania

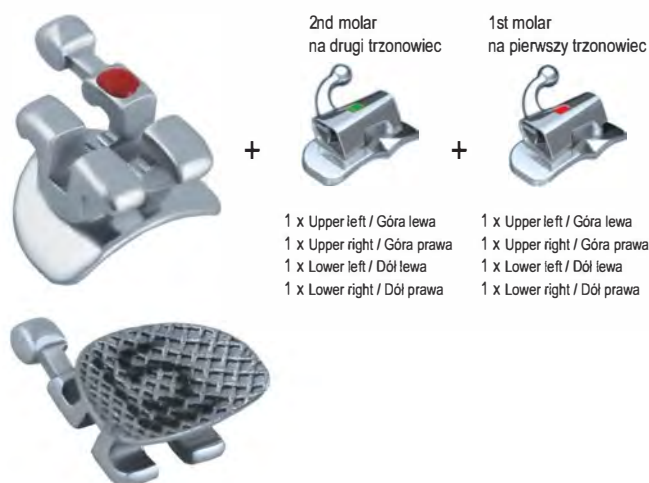

- 1 x Upper left / Góra lewa
- 1 x Upper right / Góra prawa
- 1 x Lower left / Dół lewa
- 1 x Lower right / Dół prawa

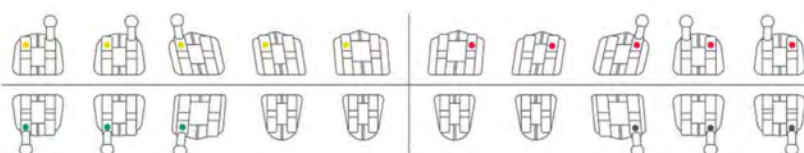

Single patient kits, 28 pieces / Zestawy dla 1 pacjenta, 28 sztuk.

Type / Typ	Hook / Haczyk	Roth
		Slot .022"
7 x 7	on 3 / na 3	DO.0719.01

MINI GEM

Two-piece Casted Bracket system, 80 gauge foil mesh bonding base
Zamki z dwóch kawałków metalu, posiadają podstawę z siateczką,
która zapewnia maksymalną siłę wiązania



Single patient kits, 28 pieces / Zestawy dla 1 pacjenta, 28 sztuk.

Type Typ	Hook Haczyk	Roth Slot .022"	MBT Slot .022"
7 x 7	3	DO.0319.01	DO.0369.01

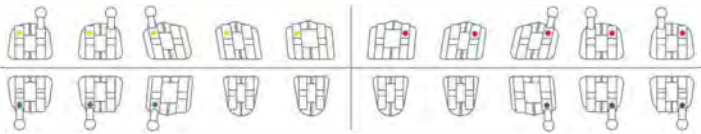

MINI GEM

Two-piece Casted Bracket system, 80 gauge foil mesh bonding base
Zamki z dwóch kawałków metalu, posiadają podstawę z siateczką,
która zapewnia maksymalną siłę wiązania



Single patient kits, 20 pieces / Zestawy dla 1 pacjenta, 20 sztuk.

Type Typ	Hook Haczyk	Roth Slot .018"	Slot .022"
5 x 5	x	DO.0308.00	DO.0318.00
5 x 5	3	DO.0308.01	DO.0318.01
5 x 5	3,4,5	DO.0308.03	DO.0318.03

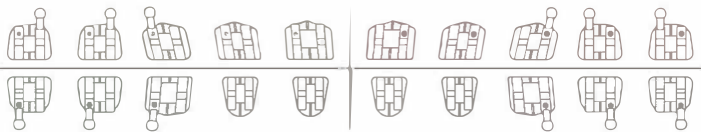

Roth System / System Rotha

Each / Sztuka

Maxillary Szczęka	Torque Tork	Angle Angulacja	Width (mm) Szerokość	In / Out mm	.018"	.022"
● UR 1	+12°	+5°	3.0	0.6	DO.0300.10	DO.0310.10
● UL 1					DO.0301.10	DO.0310.20
● UR 2	+8°	+9°	2.6	1.1	DO.0300.20	DO.0311.10
● UL 2					DO.0301.20	DO.0311.20
● UR 3	-2°	+13°	2.8	0.6	DO.0300.30	DO.0310.30
● UL 3					DO.0301.30	DO.0311.30
● UR 3 (hook / haczyk)	-2°	+13°	2.8	0.6	DO.0300.31	DO.0310.31
● UL 3 (hook / haczyk)					DO.0301.31	DO.0311.31
● UR 4/5	-7°	0°	2.6	0.6	DO.0300.40	DO.0310.40
● UL 4/5					DO.0301.40	DO.0311.40
● UR 4/5 (hook / haczyk)	-7°	0°	2.6	0.6	DO.0300.41	DO.0310.41
● UL 4/5 (hook / haczyk)					DO.0301.41	DO.0311.41

Each / Sztuka

Mandibular Żuchwa	Torque Tork	Angle Angulacja	Width (mm) Szerokość	In / Out mm	.018"	.022"
● Universal 1/2	-1°	0°	2.4	1.0	DO.0303.10	DO.0313.10
● LR 3	-11°	+7°	2.8	0.6	DO.0303.30	DO.0313.30
● LL 3					DO.0304.30	DO.0314.30
● LR 3 (hook / haczyk)	-11°	+7°	2.8	0.6	DO.0303.31	DO.0313.31
● LL 3 (hook / haczyk)					DO.0304.31	DO.0314.31
● LR 4	-17°	0°	2.6	0.6	DO.0303.40	DO.0313.40
● LL 4					DO.0304.40	DO.0314.40
● LR 4 (hook / haczyk)	-17°	0°	2.6	0.6	DO.0303.41	DO.0313.41
● LL 4 (hook / haczyk)					DO.0304.41	DO.0314.41
● LR 5	-22°	0°	2.6	0.6	DO.0303.50	DO.0313.50
● LL 5					DO.0304.50	DO.0314.50
● LR 5 (hook / haczyk)	-22°	0°	2.6	0.6	DO.0303.51	DO.0313.51
● LL 5 (hook / haczyk)					DO.0304.51	DO.0314.51

Falcon's version of Roth is not implied to be an exact version of any other system,
nor do we claim any endorsement of Dr. Roth.

MINI GEM

Two-piece Casted Bracket system, 80 gauge foil mesh bonding base
Zamki z dwóch kawałków metalu, posiadają podstawę z siateczką,
która zapewnia maksymalną siłę wiązania

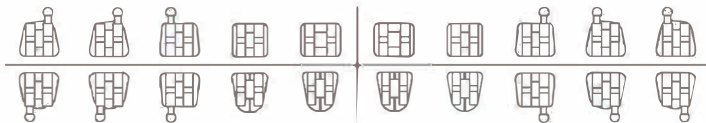

Edgewise System / System Edgewise

Each / Sztuka

Maxillary Szczeka	Torque Tork	Angle Angulacja	Width (mm) Szerokość	In / Out mm	.018"	.022"
Universal 1	0°	0°	3.0	0.65	DO.0330.10	DO.0340.10
Universal 2	0°	0°	2.6	0.65	DO.0330.20	DO.0340.20
Universal 3	0°	0°	2.6	0.65	DO.0330.30	DO.0340.30
UR 3 (hook / haczyk) UL 3 (hook / haczyk)	0°	0°	2.6	0.65	DO.0330.31 DO.0331.31	DO.0340.31 DO.0341.31
Universal 4/5	0°	0°	2.6	0.65	DO.0330.40	DO.0340.40
UR 4/5 (hook / haczyk) UL 4/5 (hook / haczyk)	0°	0°	2.6	0.65	DO.0330.41 DO.0331.41	DO.0340.41 DO.0341.41

MINI GEM

Two-piece Casted Bracket system, 80 gauge foil mesh bonding base
Zamki z dwóch kawałków metalu, posiadają podstawę z siateczką,
która zapewnia maksymalną siłę wiązania

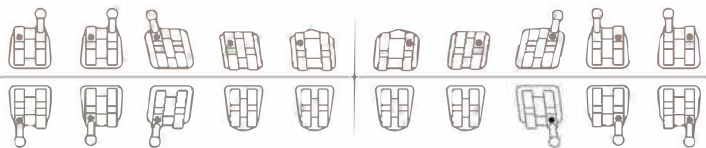

Mclaughlin, Benett and Trevisi System

Each / Sztuka

	Torque Tork	Angle Angulacja	Width (mm) Szerokość	In / Out mm	.018"	.022"
● UR 1 ● Maxillary ● Szczeka	+17°	+4°	3.4	0.6	DO.0350.10 DO.0351.10	DO.0360.10 DO.0361.10
● UL 2	+17°	+4°	2.8	1.0	DO.0350.20	DO.0360.20
● UR 3 ● UL 3	+10°	+8°	3.0	0.5	DO.0350.30 DO.0351.30	DO.0360.30 DO.0361.30
● UR 3 (hook / haczyk) ● UL 3 (hook / haczyk)	+10°	+8°	3.0	0.5	DO.0350.31 DO.0351.31	DO.0360.31 DO.0361.31
● UR 4/5 ● UL 4/5	-7°	0°	2.8	0.6	DO.0350.40 DO.0351.40	DO.0360.40 DO.0361.40
● UR 4/5 (hook / haczyk) ● UL 4/5 (hook / haczyk)	-7°	0°	2.8	0.6	DO.0350.41 DO.0351.41	DO.0360.41 DO.0361.41

Falcon's version of Mclaughlin, Benett and Trevisi System is not implied to be an exact version of any other system, nor do we claim any endorsement of the doctors.



Single patient kits, 20 pieces / Zestawy dla 1 pacjenta, 20 sztuk.

Type Typ	Hook Haczyk	Edgewise	
		Slot .018"	Slot .022"
5 x 5	x	DO.0338.00	DO.0348.00
5 x 5	3	DO.0338.01	DO.0348.01
5 x 5	3,4,5	DO.0338.03	DO.0348.03

Mandibular Żuchwa	Torque Tork	Angle Angulacja	Width (mm) Szerokość	In / Out mm	.018"	.022"
Universa 1 ½	-1°	0°	2.4	1.0	DO.0333.10	DO.0343.10
Universal 3	-11°	+7°	2.8	0.6	DO.0333.30	DO.0343.30
LR 3 (hook / haczyk) LL 3 (hook / haczyk)	-11°	+7°	2.8	0.6	DO.0333.31 DO.0334.31	DO.0343.31 DO.0344.31
Universal 4/5	-17°	0°	2.6	0.6	DO.0333.40	DO.0343.40
LR 4/5 (hook / haczyk) LL 4/5 (hook / haczyk)	17°	0°	2.6	0.6	DO.0333.41 DO.0334.41	DO.0343.41 DO.0344.41



Single patient kits, 20 pieces / Zestawy dla 1 pacjenta, 20 sztuk.

Type Typ	Hook Haczyk	MBT	
		Slot .018"	Slot .022"
5 x 5	x	DO.0358.00	DO.0368.00
5 x 5	3	DO.0358.01	DO.0368.01
5 x 5	3,4,5	DO.0358.03	DO.0368.03

Mandibular Żuchwa	Torque Tork	Angle Angulacja	Width (mm) Szerokość	In / Out mm	.018"	.022"
● Universal 1 ½	-6°	0°	2.4	1.0	DO.0353.10	DO.0363.10
● LR 3 ● LL 3	-6°	+3°	3.0	0.5	DO.0353.30 DO.0354.30	DO.0363.30 DO.0364.30
● LR 3 (hook / haczyk) ● LL 3 (hook / haczyk)	-6°	+3°	3.0	0.5	DO.0353.31 DO.0354.31	DO.0363.31 DO.0364.31
● LR 4 ● LL 4	-11°	0°	2.8	0.5	DO.0353.40 DO.0354.40	DO.0363.40 DO.0364.40
● LR 4 (hook / haczyk) ● LL 4 (hook / haczyk)	-11°	0°	2.8	0.5	DO.0353.41 DO.0354.41	DO.0363.41 DO.0364.41
● LR 5 ● LL 5	-16°	0°	2.8	0.5	DO.0353.50 DO.0354.50	DO.0363.50 DO.0364.50
● LR 5 (hook / haczyk) ● LL 5 (hook / haczyk)	-16°	0°	2.8	0.5	DO.0353.51 DO.0354.51	DO.0363.51 DO.0364.51

MARK I

One piece MIM bracket system
Zamki z jednego kawałka metalu
Wykonane metodą wtryskową MIM



Type / Typ	Hook / Haczyk	Roth / Rotha	
		Slot .018"	Slot .022"
5 x 5	3	DO.0108.01	DO.0118.01
5 x 5	3, 4, 5	DO.0108.03	DO.0118.03



MARK II

Two piece bracket system, laser welded
z dwóch kawałków metalu
Zgrzewane laserowo



Single patient kits, 20 pieces / Zestawy dla 1 pacjenta, 20 sztuk.

Type / Typ	Hook / Haczyk	Roth / Rotha	
		Slot .018"	Slot .022"
5 x 5	3	DO.0208.01	DO.0218.01
5 x 5	3, 4, 5	DO.0208.03	DO.0218.03





One piece MIM, twin design bracket system
Zamki Twin MIM z jednego kawałka metalu

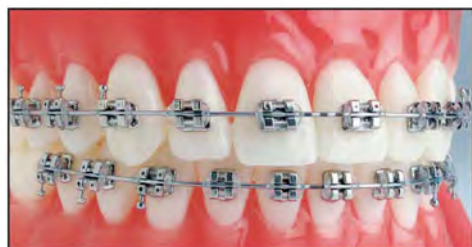

Metal injection molded (MIM)
One piece, metal injection molded from high grade stainless steel alloy.
Highly resistant to corrosion
Mesh bonding pad
Provides maximum retention

each / sztuka

Ultra low profile
For added patient comfort
Torque-in-base



Metal Injection Molded (MIM)
Zamki z jednego kawałka najwyższego jakościowo metalu wykonane metodą wtryskową MIM. Niezwykłe odporne na korozję.
Podstawa pokryta siateczką
Zapewniająca maksymalną retencja
Bardzo niski profil
Dla polepszenia komfortu pacjenta
Tork w podstawie

System Roth / System Rotha

Turbo II brackets are also available in following perscriptions on special orders / Zamki Turbo II są dostępne w następujących systemach na specjalne zamówienie Roth 'V' Slot, Ricketts/Hilgers, standard Edgewise and MBT

Maxillary / Szczęka		Torque Tork	Angle Angulacja	Width(mm) Szerokość	Slot .018"	Slot .022"	
	Right / Yellow Prawa / Żółty	1	+12°	+5°	3.5	DO.0500.10	DO.0510.10
	Left / Red Lewa / Czerwony	1	+12°	+5°	3.5	DO.0501.10	DO.0511.10
	Right / Yellow Prawa / Żółty	2	+8°	+9°	3.0	DO.0500.20	DO.0510.20
	Left / Red Lewa / Czerwony	2	+8°	+9°	3.0	DO.0501.20	DO.0511.20
	Right / Yellow Prawa / Żółty	3	+0°	+11°	3.5	DO.0500.31	DO.0510.31
	Left / Red Lewa / Czerwony	3	+0°	+11°	3.5	DO.0501.31	DO.0511.31
	Right / Yellow Prawa / Żółty	3	+0°	+11°	3.5	DO.0500.30	DO.0510.30
	Left / Red Lewa / Czerwony	3	+0°	+11°	3.5	DO.0501.30	DO.0511.30
	Right / Yellow Prawa / Żółty	5, 4	-7°	0°	3.0	DO.0500.41	DO.0510.41
	Left / Red Lewa / Czerwony	4, 5	-7°	0°	3.0	DO.0501.41	DO.0511.41
	Right / Yellow Prawa / Żółty	5, 4	-7°	0°	3.0	DO.0500.40	DO.0510.40
	Left / Red Lewa / Czerwony	4, 5	-7°	0°	3.0	DO.0501.40	DO.0511.40

Mandibular / Żuchwa		Torque Tork	Angle Angulacja	Width(mm) Szerokość	Slot .018"	Slot .022"	
	Universal Uniwersalna	FDI 31, 32, 41, 42 2, 1, 1, 2	0°	0°	2.5	DO.0503.10	DO.0513.10
	Right / Black Prawa / Czarny	FDI 43 3	-11°	+5°	3.0	DO.0503.31	DO.0513.31
	Left / Blue Lewa / Niebieski	FDI 33 3	-11°	+5°	3.0	DO.0504.31	DO.0514.31
	Right / Black Prawa / Czarny	FDI 43 3	-11°	+5°	3.0	DO.0503.30	DO.0513.30
	Left / Blue Lewa / Niebieski	FDI 33 3	-11°	+5°	3.0	DO.0504.30	DO.0514.30
	Right / Black Prawa / Czarny	FDI 44 4	-17°	0°	3.0	DO.0503.41	DO.0513.41
	Left / Blue Lewa / Niebieski	FDI 34 4	-17°	0°	3.0	DO.0504.41	DO.0514.41
	Right / Black Prawa / Czarny	FDI 44 4	-17°	0°	3.0	DO.0503.40	DO.0513.40
	Left / Blue Lewa / Niebieski	FDI 34 4	-17°	0°	3.0	DO.0504.40	DO.0514.40
	Right / Black Prawa / Czarny	FDI 45 5	-22°	0°	3.0	DO.0503.51	DO.0513.51
	Left / Blue Lewa / Niebieski	FDI 35 5	-22°	0°	3.0	DO.0504.51	DO.0514.51
	Right / Black Prawa / Czarny	FDI 45 5	-22°	0°	3.0	DO.0503.50	DO.0513.50
	Left / Blue Lewa / Niebieski	FDI 35 5	-22°	0°	3.0	DO.0504.50	DO.0514.50

The above version of Roth is not implied to be an exact version of any other system, nor do we claim any endorsement of Dr. Roth.

Single patient kits, 20 pieces / Zestawy dla 1 pacjenta, 20 sztuk.

Type / Typ	Hook / Haczyk	Roth / Rotha	
		Slot .018"	Slot .022"
5 x 5	x	DO.0508.00	DO.0518.00
5 x 5	3	DO.0508.01	DO.0518.01
5 x 5	3, 4, 5	DO.0508.03	DO.0518.03





CERAMIKA-I

Ceramic bracket system / Zamki ceramiczne

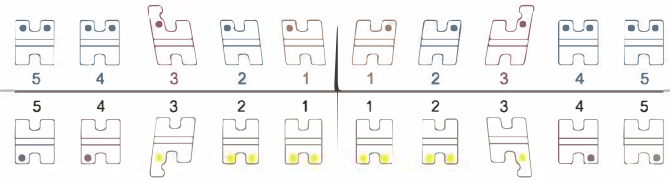

Single patient kits, 20 pieces / Zestawy dla 1 pacjenta, 20 sztuk.

Type / Typ	Hook / Haczyk	Roth / Rotha		MBT / MBT	
		Slot .018"	Slot .022"	Slot .018"	Slot .022"
5 x 5	3	DO.1008.01	DO.1018.01	DO.1009.01	DO.1019.01
5 x 5	3, 4, 5	DO.1008.03	DO.1018.03	DO.1009.03	DO.1019.03



CERAMIKA-II

Ceramic bracket system / Zamki ceramiczne

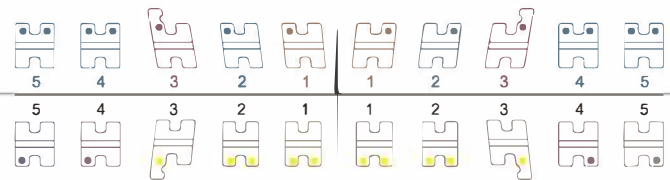

Single patient kits, 20 pieces / Zestawy dla 1 pacjenta, 20 sztuk.

Type / Typ	Hook / Haczyk	Roth / Rotha		MBT / MBT	
		Slot .018"	Slot .022"	Slot .018"	Slot .022"
5 x 5	3	DO.1108.01	DO.1118.01	DO.1109.01	DO.1119.01
5 x 5	3, 4, 5	DO.1108.03	DO.1118.03	DO.1109.03	DO.1119.03



CERAMIKA-III

Ceramic bracket system with nickel free metal slot
Zamki ceramiczne z metalowym slotem bez niklu

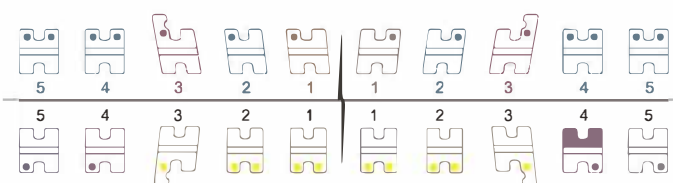

Single patient kits, 20 pieces / Zestawy dla 1 pacjenta, 20 sztuk.

Type / Typ	Hook / Haczyk	Roth / Rotha	
		Slot .018"	Slot .022"
5 x 5	3	DO.1308.01	DO.1318.01

AQUA

Transparent aesthetic bracket system
Zamki kosmetyczne transparentne

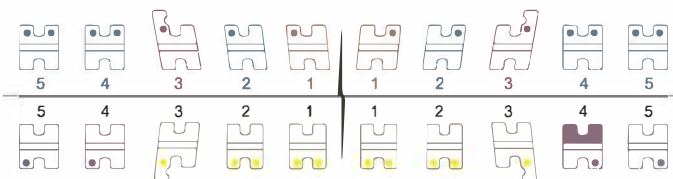

Single patient kits, 20 pieces / Zestawy dla 1 pacjenta, 20 sztuk.

Type / Typ	Hook / Haczyk	Roth / Rotha	
		Slot .018"	Slot .022"
5 x 5	3	DO.1408.01	DO.1418.01
5 x 5	3, 4, 5	DO.1408.03	DO.1418.03



DO.1992.00
Brackets organizer for 20 sets
Organizer na zamki, na 20 zestawów



Ceramika

CERAMIC BRACKET SYSTEM

Ceramic bracket system Zamki ceramiczne

- Made of 99.9% pure Polycrystalline Alumina
- Smooth slot design for improved sliding mechanism
- Resistant to slot-wear and fracturing
- Resistant to staining or discoloration
- Bonds and debonds like metal brackets

- Najwyższej jakości materiał 99,9% glinki polikrystalicznej
- Redukcja tarcia dzięki gładkiemu wykończeniu slotu
- Zamki o wyjątkowej wytrzymałości, odporne na uszkodzenia, pęknięcia oraz zużycie się slotu
- Odporne na przebarwienia oraz zmianę koloru
- Przyklejają się i odklejają jak zamki metalowe



Identification System

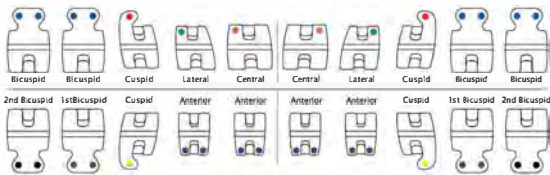

Roth System / System Rotha

each / sztuka

Maxillary / Szczerka		Torque Tork	Angle Angulacja	Width(mm) Szerokość	Slot .018"	Slot .022"
Right / Orange Prawa / Pomarańczowy	1 FDI 11	+12°	+5°	3.9	DD.1200.10	DD.1210.10
Left / Orange Lewa / Pomarańczowy	1 FDI 21	+12°	+5°	3.9	DD.1201.10	DD.1211.10
Right / Green Prawa / Zielony	2 FDI 12	+8°	+9°	3.4	DD.1200.20	DD.1210.20
Left / Green Lewa / Zielony	2 FDI 22	+8°	+9°	3.4	DD.1201.20	DD.1211.20
Right / Red Prawa / Czerwony	3 FDI 13	+0°	+11°	3.4	DD.1200.31	DD.1210.31
Left / Red Lewa / Czerwony	3 FDI 23	+0°	+11°	3.4	DD.1201.31	DD.1211.31
Right / Red Prawa / Czerwony	3 FDI 13	+0°	+11°	3.4	DD.1200.30	DD.1210.30
Left / Red Lewa / Czerwony	3 FDI 23	+0°	+11°	3.4	DD.1201.30	DD.1211.30
Universal / Blue Uniwersalna / Niebieski	5, 4 4, 5 FDI 14, 15, 24, 25	-7°	0°	3.3	DD.1200.41	DD.1210.41
Universal / Blue Uniwersalna / Niebieski	5, 4 4, 5 FDI 14, 15, 24, 25	-7°	0°	3.3	DD.1200.40	DD.1210.40

The above version of Roth is not implied to be an exact version of any other system, nor do we claim any endorsement of Dr. Roth.

each / sztuka

Mandibular / Żuchwa		Torque Tork	Angle Angulacja	Width(mm) Szerokość	Slot .018"	Slot .022"
Universal Uniwersalna	FDI 31,32,41,42 2,1 1,2	0°	0°	2.8	DD.1203.10	DD.1213.10
Right / Yellow Prawa / Żółty	FDI 43 3	-11°	+5°	3.4	DD.1203.31	DD.1213.31
Left / Yellow Lewa / Żółty	FDI 33 3	-11°	+5°	3.4	DD.1204.31	DD.1214.31
Right / Yellow Prawa / Żółty	FDI 43 3	-11°	+5°	3.4	DD.1203.30	DD.1213.30
Left / Yellow Lewa / Żółty	FDI 33 3	-11°	+5°	3.4	DD.1204.30	DD.1214.30
Universal / Brown Uniwersalna / Brązowy	FDI 34,44 4 4	-17°	0°	3.4	DD.1203.41	DD.1213.41
Universal / Brown Uniwersalna / Brązowy	FDI 34,44 4 4	-17°	0°	3.4	DD.1203.40	DD.1213.40
Universal / Black Uniwersalna / Czarny	FDI 35,45 5 5	-22°	0°	3.4	DD.1203.51	DD.1213.51
Universal / Black Uniwersalna / Czarny	FDI 35,45 5 5	-22°	0°	3.4	DD.1203.50	DD.1213.50

Single patient kits, 20 pieces / Zestawy dla 1 pacjenta, 20 sztuk.

Type / Typ	Hook / Haczyk	Roth / Rotha	
		Slot .018"	Slot .022"
5 x 5	x	DD.1208.00	DD.1218.00
5 x 5	3	DD.1208.01	DD.1218.01
5 x 5	3, 4, 5	DD.1208.03	DD.1218.03



RAV COMPOSITE BRACKET SYSTEM











Composite bracket system Zamki kompozytowe

- Made of high quality composite
- Smooth slot design for improved sliding mechanism
- Resistant to slot-wear and fracturing
- Resistant to staining or discoloration
- Bonds and debonds like metal brackets
- Also available in Standard Edgewise system, please ask for details

- Zamki wykonane z wysokiej jakości kompozytu
- Redukcja tarcia dzięki gładkiemu wykończeniu slotu
- Zamki o wyjątkowej wytrzymałości, odporne na uszkodzenia, pęknięcia oraz zużycie się slotu
- Odporne na przebarwienia oraz zmianę koloru
- Przyklejają się i odklejają jak zamki metalowe
- Dostępne również w wersji Standard Edgewise









Roth System / System Rotha

Maxillary / Szczęka		Torque Tork	Angle Angulacja	Width(mm) Szerokość	Slot .018"	Slot .022"
 Right / Black Prawa / Czarny	1 FDI 11	+12°	+5°	3.6	DO.0800.10	DO.0810.10
 Left / Black Lewa / Czarny	1 FDI 21	+12°	+5°	3.6	DO.0801.10	DO.0811.10
 Right / Red Prawa / Czerwony	2 FDI 12	+8°	+9°	3.2	DO.0800.20	DO.0810.20
 Left / Red Lewa / Czerwony	2 FDI 22	+8°	+9°	3.2	DO.0801.20	DO.0811.20
 Right / Green Prawa / Zielony	3 FDI 13	0°	+11°	3.5	DO.0800.31	DO.0810.31
 Left / Green Lewa / Zielony	3 FDI 23	0°	+11°	3.5	DO.0801.31	DO.0811.31
 Right / Orange Prawa / Pomarańczowy	5, 4 FDI 14, 15	-7°	0°	3.2	DO.0800.41	DO.0810.41
 Left / Orange Lewa / Pomarańczowy	4, 5 FDI 24, 25	-7°	0°	3.2	DO.0801.41	DO.0811.41



The above version of Roth is not implied to be an exact version of any other system, nor do we claim any endorsement of Dr. Roth.

Mandibular / Żuchwa		Torque Tork	Angle Angulacja	Width(mm) Szerokość	Slot .018"	Slot .022"
 Universal / Yellow Uniwersalna / Żółta	FDI 31, 32, 41, 42 2, 1 1, 2	0°	0°	3.0	DO.0803.10	DO.0813.10
 Right / Purple Prawa / Fiolet	FDI 43 3	-11°	+5°	3.5	DO.0803.31	DO.0813.31
 Left / Purple Lewa / Fiolet	FDI 33 3	-11°	+5°	3.5	DO.0804.31	DO.0814.31
 Right / Brown Prawa / Brązowy	FDI 44 4	-17°	0°	3.2	DO.0803.41	DO.0813.41
 Left / Brown Lewa / Brązowy	FDI 34 4	-17°	0°	3.2	DO.0804.41	DO.0814.41
 Right / Navy blue Prawa / Granatowy	FDI 45 5	-22°	0°	3.2	DO.0803.51	DO.0813.51
 Left / Navy blue Lewa / Granatowy	FDI 35 5	-22°	0°	3.2	DO.0804.51	DO.0814.51



Single patient kits, 20 pieces / Zestawy dla 1 pacjenta, 20 sztuk.

Type / Typ	Hook / Haczyk	Roth / Rotha	
		Slot .018"	Slot .022"
5 x 5	3, 4, 5	DO.0808.03	DO.0818.03

Stackable brackets organizer Kaseta do zamków



DO.1995.00

with 4 disposable bonding trays with mixing wells
z 4 jednorazowe podstawki do zamków z miejscem do mieszania

Komposito

COMPOSITE BRACKET SYSTEM







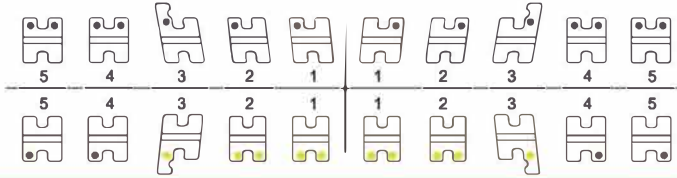
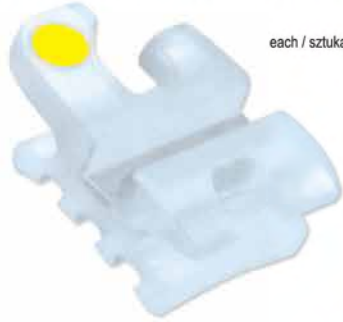



Composite bracket system / Zamki kompozytowe

- Made of medical grade Polyurethane
- Smooth slot design for improved sliding mechanism
- Resistant to slot-wear and fracturing
- Resistant to staining or discoloration
- Bonds and debonds like metal brackets









- Niezwykła wytrzymałość zawdzięczają poliuretanowi
- Redukcja tarcia dzięki gładkiemu wykończeniu slotu
- Zamki o wyjątkowej wytrzymałości, odporne na uszkodzenia, pęknięcia oraz zużycie się slotu
- Odporne na przebarwienia oraz zmianę koloru
- Przyklejają się i odklejają jak zamki metalowe



Roth System / System Rotha

Maxillary / Szczęka		Torque Tork	Angle Angulacja	Width(mm) Szerokość	Slot .018"	Slot .022"
	Right / Orange Prawa / Pomarańczowy FDI 11	+12°	+5°	3.9	DO.0900.10	DO.0910.10
	Left / Orange Lewa / Pomarańczowy FDI 21	+12°	+5°	3.9	DO.0901.10	DO.0911.10
	Right / Green Prawa / Zielony FDI 12	+8°	+9°	3.4	DO.0900.20	DO.0910.20
	Left / Green Lewa / Zielony FDI 22	+8°	+9°	3.4	DO.0901.20	DO.0911.20
	Right / Red Prawa / Czerwony FDI 13	+0°	+11°	3.4	DO.0900.31	DO.0910.31
	Left / Red Lewa / Czerwony FDI 23	+0°	+11°	3.4	DO.0901.31	DO.0911.31
	Right / Red Prawa / Czerwony FDI 13	+0°	+11°	3.4	DO.0900.30	DO.0910.30
	Left / Red Lewa / Czerwony FDI 23	+0°	+11°	3.4	DO.0901.30	DO.0911.30
	Universal / Blue Uniwersalna / Niebieski FDI 14, 15, 24, 25	-7°	0°	3.3	DO.0900.41	DO.0910.41
	Universal / Blue Uniwersalna / Niebieski FDI 14, 15, 24, 25	-7°	0°	3.3	DO.0900.40	DO.0910.40

The above version of Roth is not implied to be an exact version of any other system, nor do we claim any endorsement of Dr. Roth

Mandibular / Żuchwa		Torque Tork	Angle Angulacja	Width(mm) Szerokość	Slot .018"	Slot .022"
	Universal Uniwersalna FDI 31,32,41,42 2,1 1,2	0°	0°	2.8	DO.0903.10	DO.0913.10
	Right / Yellow Prawa / Żółty FDI 43 3	-11°	+5°	3.4	DO.0903.31	DO.0913.31
	Left / Yellow Lewa / Żółty FDI 33 3	-11°	+5°	3.4	DO.0904.31	DO.0914.31
	Right / Yellow Prawa / Żółty FDI 43 3	-11°	+5°	3.4	DO.0903.30	DO.0913.30
	Left / Yellow Lewa / Żółty FDI 33 3	-11°	+5°	3.4	DO.0904.30	DO.0914.30
	Universal / Brown Uniwersalna / Brązowy FDI 34,44 4 4	-17°	0°	3.4	DO.0903.41	DO.0913.41
	Universal / Brown Uniwersalna / Brązowy FDI 34,44 4 4	-17°	0°	3.4	DO.0903.40	DO.0913.40
	Universal / Black Uniwersalna / Czarny FDI 35,45 5 5	-22°	0°	3.4	DO.0903.51	DO.0913.51
	Universal / Black Uniwersalna / Czarny FDI 35,45 5 5	-22°	0°	3.4	DO.0903.50	DO.0913.50

Single patient kits, 20 pieces / Zestawy dla 1 pacjenta, 20 sztuk.

Type / Typ	Hook / Haczyk	Roth / Rotha	
		Slot .018"	Slot .022"
5 x 5	x	DO.0908.00	DO.0918.00
5 x 5	3	DO.0908.01	DO.0918.01
5 x 5	3, 4, 5	DO.0908.03	DO.0918.03



Sure-Fit

Upper 1st Molar bands size chart



Sure-Fit	3M Unitek Victory Series	GAC-SnapFit	Dentaurum-Dentaform	Ortho Technology
	x	x	x	30
	x	x	x	30.5
	31	3	8	31
	31.5	4	x	31.5
	32	5	9	32
	32.5	6	10	32.5
	33	7	11	33
	33.5	8	12	33.5
	34	9	13	34
	34.5	10	14	34.5
	35	11	16	35
	35.5	12	17	35.5
	36	13	18	36
	36.5	14	19	36.5
	37	15	x	x
	37.5	16	22	x
	38	17	23	x
	38.5	18	24	x
	39	19	25	x
	39.5	20	27	x
	40	21	x	x
	40.5	22	28	x
	41	23	x	x
	41.5	24	32	x
	42	25	x	x
	42.5	26	x	x
	43	27	x	x
	43.5	28	x	x
	44	29	x	x
	44.5	30	x	x

Sure-Fit

Lower 1st Molar bands size chart



Sure-Fit	3M Unitek Victory Series	GAC-SnapFit	Dentaurum-Dentaform	Ortho Technology
	30	x	x	30
	30.5	2	x	30.5
	31	x	8	31
	31.5	x	x	31.5
	32	x	9	32
	32.5	x	10	32.5
	33	x	11	33
	33.5	x	12	33.5
	34	x	13	34
	34.5	x	14	34.5
	35	x	16	35
	35.5	7	17	35.5
	36	8	18	36
	36.5	9	19	36.5
	37	15	x	x
	37.5	16	22	x
	38	17	23	x
	38.5	18	24	x
	39	19	25	x
	39.5	20	27	x
	40	21	x	x
	40.5	22	28	x
	41	23	x	x
	41.5	24	32	x
	42	25	x	x
	42.5	26	x	x
	43	27	x	x
	43.5	28	x	x
	x	29	x	x
	x	30	x	x

Sure-Fit

1st Molar bands plain / Pierścienie gładkie na pierwsze trzonowce

each / sztuka

Anatomically shaped / Anatomiczny kształt pierścienia
Fast, placement and accurate fit
Umożliwia szybkie umiejscowienie i dokładne jego dopasowanie

Micro-Etched interior surface / Mikrowytrawiona wewnętrzna powierzchnia
For increased bond strength
Zapewnia maksymalne utrzymanie

Rounded edges / Zawinięte brzegi
No sharp edges for patient comfort
Gładko wykończone krawędzie zapewniają maksymalny komfort pacjenta

Permanent laser marking / Trwałe laserowe oznakowanie
For easy identification
Zapewnia łatwą identyfikację

Ideally hardened stainless steel, for easy contouring
Doskonale zahałowane materiały, z którego wykonane są pierścienie ułatwia dopasowanie obwodu pierścienia do zęba

Band Size / Rozmiar	Upper Left / Góra lewa	Upper Right / Góra prawa	Lower Left / Dół lewy	Lower Right / Dół prawy
30	x	x	DO.2020.04	DO.2030.04
30.5	x	x	DO.2020.05	DO.2030.05
31	DO.2000.06	DO.2010.06	DO.2020.06	DO.2030.06
31.5	DO.2000.07	DO.2010.07	DO.2020.07	DO.2030.07
32	DO.2000.08	DO.2010.08	DO.2020.08	DO.2030.08
32.5	DO.2000.09	DO.2010.09	DO.2020.09	DO.2030.09
33	DO.2000.10	DO.2010.10	DO.2020.10	DO.2030.10
33.5	DO.2000.11	DO.2010.11	DO.2020.11	DO.2030.11
34	DO.2000.12	DO.2010.12	DO.2020.12	DO.2030.12
34.5	DO.2000.13	DO.2010.13	DO.2020.13	DO.2030.13
35	DO.2000.14	DO.2010.14	DO.2020.14	DO.2030.14
35.5	DO.2000.15	DO.2010.15	DO.2020.15	DO.2030.15
36	DO.2000.16	DO.2010.16	DO.2020.16	DO.2030.16
36.5	DO.2000.17	DO.2010.17	DO.2020.17	DO.2030.17
37	DO.2000.18	DO.2010.18	DO.2020.18	DO.2030.18
37.5	DO.2000.19	DO.2010.19	DO.2020.19	DO.2030.19
38	DO.2000.20	DO.2010.20	DO.2020.20	DO.2030.20
38.5	DO.2000.21	DO.2010.21	DO.2020.21	DO.2030.21
39	DO.2000.22	DO.2010.22	DO.2020.22	DO.2030.22
39.5	DO.2000.23	DO.2010.23	DO.2020.23	DO.2030.23
40	DO.2000.24	DO.2010.24	DO.2020.24	DO.2030.24
40.5	DO.2000.25	DO.2010.25	DO.2020.25	DO.2030.25
41	DO.2000.26	DO.2010.26	DO.2020.26	DO.2030.26
41.5	DO.2000.27	DO.2010.27	DO.2020.27	DO.2030.27
42	DO.2000.28	DO.2010.28	DO.2020.28	DO.2030.28
42.5	DO.2000.29	DO.2010.29	DO.2020.29	DO.2030.29
43	DO.2000.30	DO.2010.30	DO.2020.30	DO.2030.30
43.5	DO.2000.31	DO.2010.31	DO.2020.31	DO.2030.31
44	DO.2000.32	DO.2010.32	x	x
44.5	DO.2000.33	DO.2010.33	x	x

1st Molar bands kits

Custom made kits are available on special order
Buy 400 bands custom kit and get bands organizer Free

Zestawy pierścieni na pierwsze trzonowce

Zestawy również na indywidualne zamówienie
Przy zakupie 400 pierścieni otrzymasz organizer gratis.

Stackable bands organizer

Organizer do pierścieni



**Free
Gratis**



DO.2000.00
Set of 4 cassettes
Zestaw zawiera 4 kasety



Sure-Fit

1st Molar pre-welded bands

Pierścienie na pierwsze trzonowce z akcesoriami

Pre-welded bands offer convenience and time saving
Pierścienie uzbrojone są łatwiejsze w użyciu i oszczędzają czas

Available in variety of pre-welded options to fit any need
Dostępna duża różnorodność pierścieni, aby zaspokoić potrzeby pacjentów.

Maxillary / Szczeka



each / sztuka

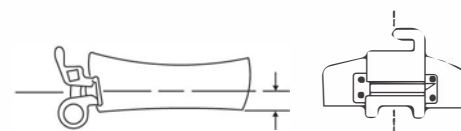

Option 1 / Wersja 1



Band / Pierścień

Non-convertible single
buccal tube .022"

Niezamienna pojedyncza
rurka .022"

Lingual Cleat
Kliit

Option 2 / Wersja 2



Band / Pierścień

Convertible double buccal tube,
occlusal headgear tube .022"

Rurka podwójna zamienna z tubą
do wyciągu zewnątrzustnego od strony
płaszczyzny zgryzowej .022"

Lingual Cleat
Kliit

Option 3 / Wersja 3



Band / Pierścień

Convertible triple buccal tube,
occlusal headgear tube .022"

Rurka potrójna zamienna z tubą
do wyciągu zewnątrzustnego od
strony płaszczyzny zgryzowej .022"

Lingual Cleat
Kliit

Left / Lewa		Right / Prawa	
LU31	DO.2001.06	RU31	DO.2011.06
LU31.5	DO.2001.07	RU31.5	DO.2011.07
LU32	DO.2001.08	RU32	DO.2011.08
LU32.5	DO.2001.09	RU32.5	DO.2011.09
LU33	DO.2001.10	RU33	DO.2011.10
LU33.5	DO.2001.11	RU33.5	DO.2011.11
LU34	DO.2001.12	RU34	DO.2011.12
LU34.5	DO.2001.13	RU34.5	DO.2011.13
LU35	DO.2001.14	RU35	DO.2011.14
LU35.5	DO.2001.15	RU35.5	DO.2011.15
LU36	DO.2001.16	RU36	DO.2011.16
LU36.5	DO.2001.17	RU36.5	DO.2011.17
LU37	DO.2001.18	RU37	DO.2011.18
LU37.5	DO.2001.19	RU37.5	DO.2011.19
LU38	DO.2001.20	RU38	DO.2011.20
LU38.5	DO.2001.21	RU38.5	DO.2011.21
LU39	DO.2001.22	RU39	DO.2011.22
LU39.5	DO.2001.23	RU39.5	DO.2011.23
LU40	DO.2001.24	RU40	DO.2011.24
LU40.5	DO.2001.25	RU40.5	DO.2011.25
LU41	DO.2001.26	RU41	DO.2011.26
LU41.5	DO.2001.27	RU41.5	DO.2011.27
LU42	DO.2001.28	RU42	DO.2011.28
LU42.5	DO.2001.29	RU42.5	DO.2011.29
LU43	DO.2001.30	RU43	DO.2011.30
LU43.5	DO.2001.31	RU43.5	DO.2011.31
LU44	DO.2001.32	RU44	DO.2011.32
LU44.5	DO.2001.33	RU44.5	DO.2011.33

Left / Lewa		Right / Prawa	
LU31	DO.2002.06	RU31	DO.2012.06
LU31.5	DO.2002.07	RU31.5	DO.2012.07
LU32	DO.2002.08	RU32	DO.2012.08
LU32.5	DO.2002.09	RU32.5	DO.2012.09
LU33	DO.2002.10	RU33	DO.2012.10
LU33.5	DO.2002.11	RU33.5	DO.2012.11
LU34	DO.2002.12	RU34	DO.2012.12
LU34.5	DO.2002.13	RU34.5	DO.2012.13
LU35	DO.2002.14	RU35	DO.2012.14
LU35.5	DO.2002.15	RU35.5	DO.2012.15
LU36	DO.2002.16	RU36	DO.2012.16
LU36.5	DO.2002.17	RU36.5	DO.2012.17
LU37	DO.2002.18	RU37	DO.2012.18
LU37.5	DO.2002.19	RU37.5	DO.2012.19
LU38	DO.2002.20	RU38	DO.2012.20
LU38.5	DO.2002.21	RU38.5	DO.2012.21
LU39	DO.2002.22	RU39	DO.2012.22
LU39.5	DO.2002.23	RU39.5	DO.2012.23
LU40	DO.2002.24	RU40	DO.2012.24
LU40.5	DO.2002.25	RU40.5	DO.2012.25
LU41	DO.2002.26	RU41	DO.2012.26
LU41.5	DO.2002.27	RU41.5	DO.2012.27
LU42	DO.2002.28	RU42	DO.2012.28
LU42.5	DO.2002.29	RU42.5	DO.2012.29
LU43	DO.2002.30	RU43	DO.2012.30
LU43.5	DO.2002.31	RU43.5	DO.2012.31
LU44	DO.2002.32	RU44	DO.2012.32
LU44.5	DO.2002.33	RU44.5	DO.2012.33

Left / Lewa		Right / Prawa	
LU31	DO.2003.06	RU31	DO.2013.06
LU31.5	DO.2003.07	RU31.5	DO.2013.07
LU32	DO.2003.08	RU32	DO.2013.08
LU32.5	DO.2003.09	RU32.5	DO.2013.09
LU33	DO.2003.10	RU33	DO.2013.10
LU33.5	DO.2003.11	RU33.5	DO.2013.11
LU34	DO.2003.12	RU34	DO.2013.12
LU34.5	DO.2003.13	RU34.5	DO.2013.13
LU35	DO.2003.14	RU35	DO.2013.14
LU35.5	DO.2003.15	RU35.5	DO.2013.15
LU36	DO.2003.16	RU36	DO.2013.16
LU36.5	DO.2003.17	RU36.5	DO.2013.17
LU37	DO.2003.18	RU37	DO.2013.18
LU37.5	DO.2003.19	RU37.5	DO.2013.19
LU38	DO.2003.20	RU38	DO.2013.20
LU38.5	DO.2003.21	RU38.5	DO.2013.21
LU39	DO.2003.22	RU39	DO.2013.22
LU39.5	DO.2003.23	RU39.5	DO.2013.23
LU40	DO.2003.24	RU40	DO.2013.24
LU40.5	DO.2003.25	RU40.5	DO.2013.25
LU41	DO.2003.26	RU41	DO.2013.26
LU41.5	DO.2003.27	RU41.5	DO.2013.27
LU42	DO.2003.28	RU42	DO.2013.28
LU42.5	DO.2003.29	RU42.5	DO.2013.29
LU43	DO.2003.30	RU43	DO.2013.30
LU43.5	DO.2003.31	RU43.5	DO.2013.31
LU44	DO.2003.32	RU44	DO.2013.32
LU44.5	DO.2003.33	RU44.5	DO.2013.33

1st Molar pre-welded bands kits

Custom made kits are available on special order
Buy 100 bands custom kit and get bands organizer Free

Zestawy pierścieni na pierwsze trzonowce z akcesoriami

Zestawy dostępne również na indywidualne zamówienie
Przy zakupie 100 pierścieni otrzymasz organizer gratis.



Free
Gratis

Sure-Fit

1st Molar pre-welded bands

Pierścienie na pierwsze trzonowce z akcesoriami i wejściem na łuk podniebny

Pre-welded bands offer convenience and time saving
 Pierścienie uzbrojone są łatwiejsze w użyciu i oszczędzają czas

Available in variety of pre-welded options to fit any need
 Dostępna duża różnorodność pierścieni, aby zaspokoić potrzeby pacjentów.

Maxillary / Szczęka

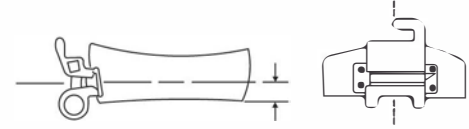

each / sztuka



Option 1.1 / Wersja 1.1



Band / Pierścień

Non-convertible single buccal tube .022"

Niezamienna pojedyncza rurka .022"

Lingual Sheath
Rurka językowa

Option 2.1 / Wersja 2.1



Band / Pierścień

Convertible double buccal tube, occlusal headgear tube .022"

Rurka podwójna zamienna z tubą do wyciągu zewnątrzustnego od strony płaszczyzny zgryzowej .022"

Lingual Sheath
Rurka językowa

Option 3.1 / Wersja 3.1



Band / Pierścień

Convertible triple buccal tube, occlusal headgear tube .022"

Rurka potrójna zamienna z tubą do wyciągu zewnątrzustnego od strony płaszczyzny zgryzowej .022"

Lingual Sheath
Rurka językowa

Left / Lewa	Right / Prawa		
LU31	DO.206.1.06	RU31	DO.2071.06
LU31.5	DO.206.1.07	RU31.5	DO.2071.07
LU32	DO.206.1.08	RU32	DO.2071.08
LU32.5	DO.206.1.09	RU32.5	DO.2071.09
LU33	DO.206.1.10	RU33	DO.2071.10
LU33.5	DO.206.1.11	RU33.5	DO.2071.11
LU34	DO.206.1.12	RU34	DO.2071.12
LU34.5	DO.206.1.13	RU34.5	DO.2071.13
LU35	DO.206.1.14	RU35	DO.2071.14
LU35.5	DO.206.1.15	RU35.5	DO.2071.15
LU36	DO.206.1.16	RU36	DO.2071.16
LU36.5	DO.206.1.17	RU36.5	DO.2071.17
LU37	DO.206.1.18	RU37	DO.2071.18
LU37.5	DO.206.1.19	RU37.5	DO.2071.19
LU38	DO.206.1.20	RU38	DO.2071.20
LU38.5	DO.206.1.21	RU38.5	DO.2071.21
LU39	DO.206.1.22	RU39	DO.2071.22
LU39.5	DO.206.1.23	RU39.5	DO.2071.23
LU40	DO.206.1.24	RU40	DO.2071.24
LU40.5	DO.206.1.25	RU40.5	DO.2071.25
LU41	DO.206.1.26	RU41	DO.2071.26
LU41.5	DO.206.1.27	RU41.5	DO.2071.27
LU42	DO.206.1.28	RU42	DO.2071.28
LU42.5	DO.206.1.29	RU42.5	DO.2071.29
LU43	DO.206.1.30	RU43	DO.2071.30
LU43.5	DO.206.1.31	RU43.5	DO.2071.31
LU44	DO.206.1.32	RU44	DO.2071.32
LU44.5	DO.206.1.33	RU44.5	DO.2071.33

Left / Lewa	Right / Prawa		
LU31	DO.2062.06	RU31	DO.2072.06
LU31.5	DO.2062.07	RU31.5	DO.2072.07
LU32	DO.2062.08	RU32	DO.2072.08
LU32.5	DO.2062.09	RU32.5	DO.2072.09
LU33	DO.2062.10	RU33	DO.2072.10
LU33.5	DO.2062.11	RU33.5	DO.2072.11
LU34	DO.2062.12	RU34	DO.2072.12
LU34.5	DO.2062.13	RU34.5	DO.2072.13
LU35	DO.2062.14	RU35	DO.2072.14
LU35.5	DO.2062.15	RU35.5	DO.2072.15
LU36	DO.2062.16	RU36	DO.2072.16
LU36.5	DO.2062.17	RU36.5	DO.2072.17
LU37	DO.2062.18	RU37	DO.2072.18
LU37.5	DO.2062.19	RU37.5	DO.2072.19
LU38	DO.2062.20	RU38	DO.2072.20
LU38.5	DO.2062.21	RU38.5	DO.2072.21
LU39	DO.2062.22	RU39	DO.2072.22
LU39.5	DO.2062.23	RU39.5	DO.2072.23
LU40	DO.2062.24	RU40	DO.2072.24
LU40.5	DO.2062.25	RU40.5	DO.2072.25
LU41	DO.2062.26	RU41	DO.2072.26
LU41.5	DO.2062.27	RU41.5	DO.2072.27
LU42	DO.2062.28	RU42	DO.2072.28
LU42.5	DO.2062.29	RU42.5	DO.2072.29
LU43	DO.2062.30	RU43	DO.2072.30
LU43.5	DO.2062.31	RU43.5	DO.2072.31
LU44	DO.2062.32	RU44	DO.2072.32
LU44.5	DO.2062.33	RU44.5	DO.2072.33

Left / Lewa	Right / Prawa		
LU31	DO.2063.06	RU31	DO.2073.06
LU31.5	DO.2063.07	RU31.5	DO.2073.07
LU32	DO.2063.08	RU32	DO.2073.08
LU32.5	DO.2063.09	RU32.5	DO.2073.09
LU33	DO.2063.10	RU33	DO.2073.10
LU33.5	DO.2063.11	RU33.5	DO.2073.11
LU34	DO.2063.12	RU34	DO.2073.12
LU34.5	DO.2063.13	RU34.5	DO.2073.13
LU35	DO.2063.14	RU35	DO.2073.14
LU35.5	DO.2063.15	RU35.5	DO.2073.15
LU36	DO.2063.16	RU36	DO.2073.16
LU36.5	DO.2063.17	RU36.5	DO.2073.17
LU37	DO.2063.18	RU37	DO.2073.18
LU37.5	DO.2063.19	RU37.5	DO.2073.19
LU38	DO.2063.20	RU38	DO.2073.20
LU38.5	DO.2063.21	RU38.5	DO.2073.21
LU39	DO.2063.22	RU39	DO.2073.22
LU39.5	DO.2063.23	RU39.5	DO.2073.23
LU40	DO.2063.24	RU40	DO.2073.24
LU40.5	DO.2063.25	RU40.5	DO.2073.25
LU41	DO.2063.26	RU41	DO.2073.26
LU41.5	DO.2063.27	RU41.5	DO.2073.27
LU42	DO.2063.28	RU42	DO.2073.28
LU42.5	DO.2063.29	RU42.5	DO.2073.29
LU43	DO.2063.30	RU43	DO.2073.30
LU43.5	DO.2063.31	RU43.5	DO.2073.31
LU44	DO.2063.32	RU44	DO.2073.32
LU44.5	DO.2063.33	RU44.5	DO.2073.33

1st Molar pre-welded bands kits

Custom made kits are available on special order
 Buy 100 bands custom kit and get bands organizer Free

Zestawy pierścieni na pierwsze trzonowce z akcesoriami

Zestawy dostępne również na indywidualne zamówienie
 Przy zakupie 100 pierścieni otrzymasz organizer gratis.



Sure-Fit

1st Molar pre-welded bands

Pierścienie na pierwsze trzonowce z akcesoriami

Pre-welded bands offer convenience and time saving
Pierścienie uzbrojone są łatwiejsze w użyciu i oszczędzają czas

Available in variety of pre-welded options to fit any need
Dostępna duża różnorodność pierścieni, aby zaspokoić potrzeby pacjentów.

Mandibular / Żuchwa

each / sztuka

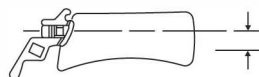

Option 1 / Wersja 1



Band / Pierścień

Non-convertible single buccal tube .022"

Niezamienna rurka pojedyncza .022"

Lingual Cleat Kit

Option 2 / Wersja 2



Band / Pierścień

Convertible single buccal tube .022"

Zamienna rurka pojedyncza .022"

Lingual Cleat Kit

Option 3 / Wersja 3



Band / Pierścień

Convertible double buccal tube .022"

Zamienna rurka podwójna .022"

Lingual Cleat Kit

Option 4 / Wersja 4



Band / Pierścień

Convertible double buccal tube, occlusal headgear tube .022"

Rurka podwójna zamienna z tubą do wyciągu zewnątrzstronowego od strony płaszczyny zgryzowej .022"

Lingual Cleat Kit

Option 1 / Wersja 1

Option 2 / Wersja 2

Option 3 / Wersja 3

Option 4 / Wersja 4

Size / Rozmiar	Left / Lewa	Right / Prawa	Left / Lewa	Right / Prawa	Left / Lewa	Right / Prawa	Left / Lewa	Right / Prawa
LL30	DO.2021.04	DO.2031.04	DO.2022.04	DO.2032.04	DO.2023.04	DO.2033.04	DO.2024.04	DO.2034.04
LL30.5	DO.2021.05	DO.2031.05	DO.2022.05	DO.2032.05	DO.2023.05	DO.2033.05	DO.2024.05	DO.2034.05
LL31	DO.2021.06	DO.2031.06	DO.2022.06	DO.2032.06	DO.2023.06	DO.2033.06	DO.2024.06	DO.2034.06
LL31.5	DO.2021.07	DO.2031.07	DO.2022.07	DO.2032.07	DO.2023.07	DO.2033.07	DO.2024.07	DO.2034.07
LL32	DO.2021.08	DO.2031.08	DO.2022.08	DO.2032.08	DO.2023.08	DO.2033.08	DO.2024.08	DO.2034.08
LL32.5	DO.2021.09	DO.2031.09	DO.2022.09	DO.2032.09	DO.2023.09	DO.2033.09	DO.2024.09	DO.2034.09
LL33	DO.2021.10	DO.2031.10	DO.2022.10	DO.2032.10	DO.2023.10	DO.2033.10	DO.2024.10	DO.2034.10
LL33.5	DO.2021.11	DO.2031.11	DO.2022.11	DO.2032.11	DO.2023.11	DO.2033.11	DO.2024.11	DO.2034.11
LL34	DO.2021.12	DO.2031.12	DO.2022.12	DO.2032.12	DO.2023.12	DO.2033.12	DO.2024.12	DO.2034.12
LL34.5	DO.2021.13	DO.2031.13	DO.2022.13	DO.2032.13	DO.2023.13	DO.2033.13	DO.2024.13	DO.2034.13
LL35	DO.2021.14	DO.2031.14	DO.2022.14	DO.2032.14	DO.2023.14	DO.2033.14	DO.2024.14	DO.2034.14
LL35.5	DO.2021.15	DO.2031.15	DO.2022.15	DO.2032.15	DO.2023.15	DO.2033.15	DO.2024.15	DO.2034.15
LL36	DO.2021.16	DO.2031.16	DO.2022.16	DO.2032.16	DO.2023.16	DO.2033.16	DO.2024.16	DO.2034.16
LL36.5	DO.2021.17	DO.2031.17	DO.2022.17	DO.2032.17	DO.2023.17	DO.2033.17	DO.2024.17	DO.2034.17
LL37	DO.2021.18	DO.2031.18	DO.2022.18	DO.2032.18	DO.2023.18	DO.2033.18	DO.2024.18	DO.2034.18
LL37.5	DO.2021.19	DO.2031.19	DO.2022.19	DO.2032.19	DO.2023.19	DO.2033.19	DO.2024.19	DO.2034.19
LL38	DO.2021.20	DO.2031.20	DO.2022.20	DO.2032.20	DO.2023.20	DO.2033.20	DO.2024.20	DO.2034.20
LL38.5	DO.2021.21	DO.2031.21	DO.2022.21	DO.2032.21	DO.2023.21	DO.2033.21	DO.2024.21	DO.2034.21
LL39	DO.2021.22	DO.2031.22	DO.2022.22	DO.2032.22	DO.2023.22	DO.2033.22	DO.2024.22	DO.2034.22
LL39.5	DO.2021.23	DO.2031.23	DO.2022.23	DO.2032.23	DO.2023.23	DO.2033.23	DO.2024.23	DO.2034.23
LL40	DO.2021.24	DO.2031.24	DO.2022.24	DO.2032.24	DO.2023.24	DO.2033.24	DO.2024.24	DO.2034.24
LL40.5	DO.2021.25	DO.2031.25	DO.2022.25	DO.2032.25	DO.2023.25	DO.2033.25	DO.2024.25	DO.2034.25
LL41	DO.2021.26	DO.2031.26	DO.2022.26	DO.2032.26	DO.2023.26	DO.2033.26	DO.2024.26	DO.2034.26
LL41.5	DO.2021.27	DO.2031.27	DO.2022.27	DO.2032.27	DO.2023.27	DO.2033.27	DO.2024.27	DO.2034.27
LL42	DO.2021.28	DO.2031.28	DO.2022.28	DO.2032.28	DO.2023.28	DO.2033.28	DO.2024.28	DO.2034.28
LL42.5	DO.2021.29	DO.2031.29	DO.2022.29	DO.2032.29	DO.2023.29	DO.2033.29	DO.2024.29	DO.2034.29
LL43	DO.2021.30	DO.2031.30	DO.2022.30	DO.2032.30	DO.2023.30	DO.2033.30	DO.2024.30	DO.2034.30
LL43.5	DO.2021.31	DO.2031.31	DO.2022.31	DO.2032.31	DO.2023.31	DO.2033.31	DO.2024.31	DO.2034.31

1st Molar pre-welded bands kits

Custom made kits are available on special order
Buy 100 bands custom kit and get bands organizer Free

Zestawy pierścieni na pierwsze trzonowce z akcesoriami

Zestawy dostępne również na indywidualne zamówienie
Przy zakupie 100 pierścieni otrzymasz organizer gratis.



Free
Gratis



Weldable buccal tubes
Rurki policzkowe do zgrzewania

Buccal tube single non-convertible 1st molar
Rurka policzkowa pojedyncza niezamienna na pierwszy trzonowiec

Maxillary / Szczęka						
Torque/Tork	Offset/Offset dziąsłowy	Slot/Slot	Rx	Headgear slot/Tuba do wyciągu zew	Upper left / Góra lewa	Upper right / Góra prawa
-14°	10°	0.22"	Roth	x	DO.2230.20	DO.2230.21
Mandibular / Żuchwa						
Torque/Tork	Offset/Offset dziąsłowy	Slot/Slot	Rx	Headgear slot/Tuba do wyciągu zew	Lower left / Dół lewa	Lower right / Dół prawa
-30°	4°	0.22"	Roth	x	DO.2240.20	DO.2240.21



Buccal tube single convertible 1st molar
Rurka policzkowa pojedyncza zamienna na pierwszy trzonowiec

Maxillary / Szczęka						
Torque/Tork	Offset/Offset dziąsłowy	Slot/Slot	Rx	Headgear slot/Tuba do wyciągu zew	Upper left / Góra lewa	Upper right / Góra prawa
-14°	10°	0.22"	Roth	x	DO.2200.20	DO.2200.21
Mandibular / Żuchwa						
Torque/Tork	Offset/Offset dziąsłowy	Slot/Slot	Rx	Headgear slot/Tuba do wyciągu zew	Lower left / Dół lewa	Lower right / Dół prawa
-30°	4°	0.22"	Roth	x	DO.2220.20	DO.2220.21



Buccal tube double convertible, occlusal headgear tube 1st molar
Rurka policzkowa podwójna zamienna z tubą do wyciągu zewnątrzustnego od strony płaszczyzny zgryzowej na pierwszy trzonowiec

Maxillary / Szczęka						
Torque/Tork	Offset/Offset dziąsłowy	Slot/Slot	Rx	Headgear slot/Tuba do wyciągu zew	Upper left / Góra lewa	Upper right / Góra prawa
-14°	10°	0.22"	Roth	.045"	DO.2205.20	DO.2205.21
Mandibular / Żuchwa						
Torque/Tork	Offset/Offset dziąsłowy	Slot/Slot	Rx	Headgear slot/Tuba do wyciągu zew	Lower left / Dół lewa	Lower right / Dół prawa
-30°	4°	0.22"	Roth	.045"	DO.2225.20	DO.2225.21



Buccal tube triple convertible, occlusal headgear tube 1st molar
Rurka policzkowa potrójna zamienna z tubą do wyciągu zewnątrzustnego od strony płaszczyzny zgryzowej na pierwszy trzonowiec

Maxillary / Szczęka						
Torque/Tork	Offset/Offset dziąsłowy	Slot/Slot	Rx	Headgear slot/Tuba do wyciągu zew	Upper left / Góra lewa	Upper right / Góra prawa
-14°	10°	0.22"	Roth	.045"	DO.2210.20	DO.2210.21



Deluxe weldable buccal tubes
Deluxe rurki policzkowe do zgrzewania

Buccal tube single convertible 1st molar
Rurka policzkowa pojedyncza zamienna na pierwszy trzonowiec



Made in USA

Maxillary / Szczęka						
Torque/Tork	Offset/Offset dziąsłowy	Slot/Slot	Rx	Headgear slot/Tuba do wyciągu zew	Upper left / Góra lewa	Upper right / Góra prawa
-14°	8°	0.18"	Roth	x	DO.2300.10	DO.2300.11
-14°	8°	0.22"	Roth	x	DO.2300.20	DO.2300.21
Mandibular / Żuchwa						
Torque/Tork	Offset/Offset dziąsłowy	Slot/Slot	Rx	Headgear slot/Tuba do wyciągu zew	Lower left / Dół lewa	Lower right / Dół prawa
-25°	5°	0.18"	Roth	x	DO.2320.10	DO.2320.11
-25°	5°	0.22"	Roth	x	DO.2320.20	DO.2320.21



Buccal tube Double convertible 1st molar
Rurka policzkowa Podwójna zamienna na pierwszy trzonowiec

Maxillary / Szczęka						
Torque/Tork	Offset/Offset dziąsłowy	Slot/Slot	Rx	Headgear slot/Tuba do wyciągu zew	Upper left / Góra lewa	Upper right / Góra prawa
-14°	8°	0.18"	Roth	.018 x .025"	DO.2303.10	DO.2303.11
-14°	8°	0.22"	Roth	.018 x .025"	DO.2303.20	DO.2303.21
Mandibular / Żuchwa						
Torque/Tork	Offset/Offset dziąsłowy	Slot/Slot	Rx	Headgear slot/Tuba do wyciągu zew	Lower left / Dół lewa	Lower right / Dół prawa
-25°	5°	0.18"	Roth	.018 x .025"	DO.2323.10	DO.2323.11
-25°	5°	0.22"	Roth	.018 x .025"	DO.2323.20	DO.2323.21



Deluxe weldable buccal tubes
Deluxe rurki policzkowe do zgrzewania



Buccal tube double convertible, occlusal headgear tube 1st molar

Rurka policzkowa podwójna zamienna na pierwszy trzonowiec z tubą do wyciągu zewnętrznego od strony płaszczyzny zgryzowej

Maxillary / Szczeka

Torque/Tork	Offset/Offset dziąsłowy	Slot/Slot	Rx	Headgear slot/Tuba do wyciągu zew	Upper left / Góra lewa	Upper right / Góra prawa
-14°	8°	0.18"	Roth	.045"	DO.2305.10	DO.2305.11
-14°	8°	0.22"	Roth	.045"	DO.2305.20	DO.2305.21



Buccal tube double convertible, gingival headgear tube 1st molar

Rurka policzkowa podwójna zamienna z tubą do wyciągu zewnętrznego od strony dziąsła

Maxillary / Szczeka

Torque/Tork	Offset/Offset dziąsłowy	Slot/Slot	Rx	Headgear slot/Tuba do wyciągu zew	Upper left / Góra lewa	Upper right / Góra prawa
-14°	8°	0.18"	Roth	.045"	DO.2307.10	DO.2307.11
-14°	8°	0.22"	Roth	.045"	DO.2307.20	DO.2307.21



Buccal tube double convertible, occlusal headgear tube 1st molar

Rurka policzkowa podwójna zamienna z tubą do wyciągu zewnętrznego od strony płaszczyzny zgryzowej

Mandibular / Żuchwa

Torque/Tork	Offset/Offset dziąsłowy	Slot/Slot	Rx	Headgear slot/Tuba do wyciągu zew	Lower left / Dół lewa	Lower right / Dół prawa
-25°	5°	0.18"	Roth	.045"	DO.2325.10	DO.2325.11
-25°	5°	0.22"	Roth	.045"	DO.2325.20	DO.2325.21



Buccal tube triple convertible, occlusal headgear tube 1st molar

Rurka policzkowa potrójna zamienna z tubą do wyciągu zewnętrznego od strony płaszczyzny zgryzowej

Maxillary / Szczeka

Torque/Tork	Offset/Offset dziąsłowy	Slot/Slot	Rx	Headgear slot/Tuba do wyciągu zew	Upper left / Góra lewa	Upper right / Góra prawa
-14°	8°	0.18"	Roth	.045"	DO.2310.10	DO.2310.11
-14°	8°	0.22"	Roth	.045"	DO.2310.20	DO.2310.21



Buccal tube single non-convertible 1st molar

Rurka policzkowa pojedyncza niezamienna na pierwszy trzonowiec

Maxillary / Szczeka

Torque/Tork	Offset/Offset dziąsłowy	Slot/Slot	Rx	Headgear slot/Tuba do wyciągu zew	Upper left / Góra lewa	Upper right / Góra prawa
-0°	0°	0.18"	Roth	x	DO.2330.10	DO.2330.11
-0°	8°	0.18"	Roth	x	DO.2330.12	DO.2330.13
-10°	8°	0.18"	Roth	x	DO.2330.14	DO.2330.15
-0°	0°	0.22"	Roth	x	DO.2330.20	DO.2330.21
-0°	8°	0.22"	Roth	x	DO.2330.22	DO.2330.23
-10°	8°	0.22"	Roth	x	DO.2330.24	DO.2330.25



Buccal tube single non-convertible 1st molar

Rurka policzkowa pojedyncza niezamienna na pierwszy trzonowiec

Mandibular / Żuchwa

Torque/Tork	Offset/Offset dziąsłowy	Slot/Slot	Rx	Headgear slot/Tuba do wyciągu zew	Lower left / Dół lewa	Lower right / Dół prawa
-0°	0°	0.18"	Roth	x	DO.2340.10	DO.2340.11
-0°	5°	0.18"	Roth	x	DO.2340.12	DO.2340.13
-25°	5°	0.18"	Roth	x	DO.2340.14	DO.2340.15
-0°	0°	0.22"	Roth	x	DO.2340.20	DO.2340.21
-0°	5°	0.22"	Roth	x	DO.2340.22	DO.2340.23
-25°	5°	0.22"	Roth	x	DO.2340.24	DO.2340.25



Buccal Double non-convertible, occlusal headgear tube 1st molar

Rurka policzkowa podwójna niezamienna z tubą do wyciągu zewnętrznego od strony płaszczyzny zgryzowej

Maxillary / Szczeka

Torque/Tork	Offset/Offset dziąsłowy	Slot/Slot	Rx	Headgear slot/Tuba do wyciągu zew	Upper left / Góra lewa	Upper right / Góra prawa
-0°	0°	0.18"	Roth	x	DO.2333.10	DO.2333.11
-0°	8°	0.18"	Roth	x	DO.2333.12	DO.2333.13
-10°	8°	0.18"	Roth	x	DO.2333.14	DO.2333.15
-0°	0°	0.22"	Roth	x	DO.2333.20	DO.2333.21
-0°	8°	0.22"	Roth	x	DO.2333.22	DO.2333.23
-10°	8°	0.22"	Roth	x	DO.2333.24	DO.2333.25



Bondable buccal tubes
Rurki policzkowe do przyklejania



Buccal tube single non-convertible with long hook 1st molar
Rurka policzkowa pojedyncza niezamienna z haczykiem na pierwszy trzonowiec

Maxillary / Szczęka

Torque/Tork	Offset/Offset dziąsłowy	Slot/Slot	Rx	Headgear slot/Tuba do wyciągu zew	Upper left / Góra lewa	Upper right / Góra prawa
-14°	10°	0.22"	Roth / MBT	x	DO.2285.20	DO.2285.21



Buccal tube single non-convertible 1st molar
Rurka policzkowa pojedyncza niezamienna na pierwszy trzonowiec

Maxillary / Szczęka

Torque/Tork	Offset/Offset dziąsłowy	Slot/Slot	Rx	Headgear slot/Tuba do wyciągu zew	Upper left / Góra lewa	Upper right / Góra prawa
-14°	10°	0.22"	Roth	x	DO.2280.20	DO.2280.21
-14°	10°	0.22"	MBT	x	DO.2282.20	DO.2282.21



Mandibular / Żuchwa

Torque/Tork	Offset/Offset dziąsłowy	Slot/Slot	Rx	Headgear slot/Tuba do wyciągu zew	Lower left / Dół lewa	Lower right / Dół prawa
-30°	4°	0.22"	Roth	x	DO.2290.20	DO.2290.21
-30°	4°	0.22"	MBT	x	DO.2292.20	DO.2292.21



Buccal tube single non-convertible 2nd molar
Rurka policzkowa pojedyncza niezamienna na drugi trzonowiec

Maxillary / Szczęka

Torque/Tork	Offset/Offset dziąsłowy	Slot/Slot	Rx	Headgear slot/Tuba do wyciągu zew	Upper left / Góra lewa	Upper right / Góra prawa
-14°	10°	0.22"	Roth	x	DO.2281.20	DO.2281.21
-14°	10°	0.22"	MBT	x	DO.2283.20	DO.2283.21



Mandibular / Żuchwa

Torque/Tork	Offset/Offset dziąsłowy	Slot/Slot	Rx	Headgear slot/Tuba do wyciągu zew	Lower left / Dół lewa	Lower right / Dół prawa
-30°	4°	0.22"	Roth	x	DO.2291.20	DO.2291.21
-30°	4°	0.22"	MBT	x	DO.2293.20	DO.2293.21



Buccal tube single convertible 1st molar
Rurka policzkowa pojedyncza zamienna na pierwszy trzonowiec

Maxillary / Szczęka

Torque/Tork	Offset/Offset dziąsłowy	Slot/Slot	Rx	Headgear slot/Tuba do wyciągu zew	Upper left / Góra lewa	Upper right / Góra prawa
-14°	10°	0.18"	Roth	x	x	x
-14°	10°	0.22"	Roth	x	DO.2250.20	DO.2250.21
-14°	10°	0.18"	MBT	x	x	x
-14°	10°	0.22"	MBT	x	DO.2251.20	DO.2251.21



Mandibular / Żuchwa

Torque/Tork	Offset/Offset dziąsłowy	Slot/Slot	Rx	Headgear slot/Tuba do wyciągu zew	Lower left / Dół lewa	Lower right / Dół prawa
-30°	4°	0.18"	Roth	x	x	x
-30°	4°	0.22"	Roth	x	DO.2270.20	DO.2270.21
-30°	4°	0.18"	MBT	x	x	x
-30°	4°	0.22"	MBT	x	DO.2271.20	DO.2271.21



Buccal tube double convertible, occlusal headgear tube 1st molar
Rurka policzkowa podwójna zamienna z tubą do wyciągu zewnątrzustnego od strony płaszczyzny zgryzowej na pierwszy trzonowiec

Maxillary / Szczęka

Torque/Tork	Offset/Offset dziąsłowy	Slot/Slot	Rx	Headgear slot/Tuba do wyciągu zew	Upper left / Góra lewa	Upper right / Góra prawa
-14°	10°	0.18"	Roth	045°	x	x
-14°	10°	0.22"	Roth	045°	DO.2255.20	DO.2255.21
-14°	10°	0.18"	MBT	045°	x	x
-14°	10°	0.22"	MBT	045°	DO.2256.20	DO.2256.21



Buccal tube triple convertible, occlusal headgear tube 1st molar
Rurka policzkowa potrójna zamienna z tubą do wyciągu zewnątrzustnego od strony płaszczyzny zgryzowej na pierwszy trzonowiec

Maxillary / Szczęka

Torque/Tork	Offset/Offset dziąsłowy	Slot/Slot	Rx	Headgear slot/Tuba do wyciągu zew	Upper left / Góra lewa	Upper right / Góra prawa
-14°	10°	0.22"	Roth	045°	DO.2260.20	DO.2260.21



Buccal tube double rectangle non-convertible 1st molar
Rurka policzkowa podwójna niezamienna na pierwszy trzonowiec

Maxillary / Szczęka

Torque/Tork	Offset/Offset dziąsłowy	Slot/Slot	Rx	Headgear slot/Tuba do wyciągu zew	Upper left / Góra lewa	Upper right / Góra prawa
-14°	10°	0.22"	Roth	x	DO.2284.20	DO.2284.21



Buccal tube double convertible 1st molar
Rurka policzkowa podwójna zamienna na pierwszy trzonowiec

Mandibular / Żuchwa

Torque/Tork	Offset/Offset dziąsłowy	Slot/Slot	Rx	Headgear slot/Tuba do wyciągu zew	Lower left / Dół lewa	Lower right / Dół prawa
-30°	4°	0.22"	Roth	x	DO.2273.20	DO.2273.21

Bondable buccal tubes Rurki policzkowe do przyklejania

Buccal tube double convertible, lip bumper tube 1st molar
Rurka policzkowa podwójna zamienna z tubą do peloty wargowej na pierwszy trzonowiec

Torque/Tork	Offset/Offset dziąsłowy	Slot/Slot	Rx	Headgear slot/Tuba do wyciągu zew	Lower left / Dół lewa	Lower right / Dół prawa
-20°	0°	0.22"	Roth	.045"	DO.2275.20	DO.2275.21
-20°	0°	0.22"	MBT	.045"	DO.2276.20	DO.2276.21

Mandibular / Żuchwa



Deluxe bondable buccal tubes Deluxe rurki policzkowe do przyklejania



Made in USA

Buccal tube single convertible 1st molar
Rurka policzkowa pojedyncza zamienna na pierwszy trzonowiec

Torque/Tork	Offset/Offset dziąsłowy	Slot/Slot	Rx	Headgear slot/Tuba do wyciągu zew	Upper left / Góra lewa	Upper right / Góra prawa
-14°	8°	0.18"	Roth	x	DO.2350.10	DO.2350.11
-14°	8°	0.22"	Roth	x	DO.2350.20	DO.2350.21

Maxillary / Szczęka



Torque/Tork	Offset/Offset dziąsłowy	Slot/Slot	Rx	Headgear slot/Tuba do wyciągu zew	Lower left / Dół lewa	Lower right / Dół prawa
-25°	5°	0.18"	Roth	x	DO.2370.10	DO.2370.11
-25°	5°	0.22"	Roth	x	DO.2370.20	DO.2370.21

Mandibular / Żuchwa

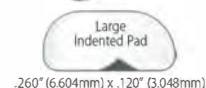

Buccal tube Double convertible 1st molar
Rurka policzkowa Podwójna zamienna na pierwszy trzonowiec

Torque/Tork	Offset/Offset dziąsłowy	Slot/Slot	Rx	Headgear slot/Tuba do wyciągu zew	Upper left / Góra lewa	Upper right / Góra prawa
-14°	8°	0.18"	Roth	.018 x .025"	DO.2353.10	DO.2353.11
-14°	8°	0.22"	Roth	.018 x .025"	DO.2353.20	DO.2353.21

Maxillary / Szczęka



Torque/Tork	Offset/Offset dziąsłowy	Slot/Slot	Rx	Headgear slot/Tuba do wyciągu zew	Lower left / Dół lewa	Lower right / Dół prawa
-25°	5°	0.18"	Roth	.018 x .025"	DO.2373.10	DO.2373.11
-25°	5°	0.22"	Roth	.018 x .025"	DO.2373.20	DO.2373.21

Mandibular / Żuchwa

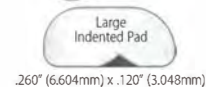

Buccal tube double convertible, occlusal headgear tube 1st molar
Rurka policzkowa podwójna zamienna na pierwszy trzonowiec z tubą do wyciągu zewnętrznego od strony płaszczyzny zgryzowej

Torque/Tork	Offset/Offset dziąsłowy	Slot/Slot	Rx	Headgear slot/Tuba do wyciągu zew	Upper left / Góra lewa	Upper right / Góra prawa
-14°	8°	0.18"	Roth	.045"	DO.2355.10	DO.2355.11
-14°	8°	0.22"	Roth	.045"	DO.2355.20	DO.2355.21

Maxillary / Szczęka



Large Indented Pad
.260" (6.604mm) x .120" (3.048mm)

Buccal tube double convertible, gingival headgear tube 1st molar
Rurka policzkowa podwójna zamienna z tubą do wyciągu zewnętrznego od strony dziąsła

Torque/Tork	Offset/Offset dziąsłowy	Slot/Slot	Rx	Headgear slot/Tuba do wyciągu zew	Upper left / Góra lewa	Upper right / Góra prawa
-14°	8°	0.18"	Roth	.045"	DO.2357.10	DO.2357.11
-14°	8°	0.22"	Roth	.045"	DO.2357.20	DO.2357.21

Maxillary / Szczęka



Buccal tube double convertible, occlusal headgear tube 1st molar
Rurka policzkowa podwójna zamienna z tubą do wyciągu zewnętrznego od strony płaszczyzny zgryzowej

Torque/Tork	Offset/Offset dziąsłowy	Slot/Slot	Rx	Headgear slot/Tuba do wyciągu zew	Lower left / Dół lewa	Lower right / Dół prawa
-25°	5°	0.18"	Roth	.045"	DO.2375.10	DO.2375.11
-25°	5°	0.22"	Roth	.045"	DO.2375.20	DO.2375.21

Mandibular / Żuchwa

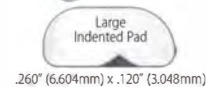

Buccal tube triple convertible, occlusal headgear tube 1st molar
Rurka policzkowa potrójna zamienna z tubą do wyciągu zewnętrznego od strony płaszczyzny zgryzowej

Torque/Tork	Offset/Offset dziąsłowy	Slot/Slot	Rx	Headgear slot/Tuba do wyciągu zew	Upper left / Góra lewa	Upper right / Góra prawa
-14°	8°	0.18"	Roth	.045"	DO.2360.10	DO.2360.11
-14°	8°	0.22"	Roth	.045"	DO.2360.20	DO.2360.21

Maxillary / Szczęka



Large Indented Pad
.260" (6.604mm) x .120" (3.048mm)



Deluxe bondable buccal tubes

Deluxe rurki policzkowe do przyklejania

Buccal tube single non-convertible 1st molar
 Rurka policzkowa pojedyncza niezamienna na pierwszy trzonowiec



Torque/Tork	Offset/Offset dziąsłowy	Slot/Slot	Rx	Headgear slot/Tuba do wyciągu zew	Upper left / Góra lewa	Upper right / Góra prawa
Maxillary / Szczeka						
0°	0°	0.18"	Roth	x	DO.2380.10	DO.2380.11
0°	0°	0.22"	Roth	x	x	DO.2380.21
Mandibular / Żuchwa						
0°	0°	0.18"	Roth	x	DO.2380.11	DO.2380.10
0°	0°	0.22"	Roth	x	DO.2380.21	x

Buccal tube single non-convertible 1st molar
 Rurka policzkowa pojedyncza niezamienna na pierwszy trzonowiec



Torque/Tork	Offset/Offset dziąsłowy	Slot/Slot	Rx	Headgear slot/Tuba do wyciągu zew	Upper left / Góra lewa	Upper right / Góra prawa
Maxillary / Szczeka						
0°	8°	0.18"	Roth	x	DO.2380.12	DO.2380.13
-10°	8°	0.18"	Roth	x	DO.2380.14	DO.2380.15
0°	8°	0.22"	Roth	x	DO.2380.22	DO.2380.23
-10°	8°	0.22"	Roth	x	DO.2380.24	DO.2380.25
Mandibular / Żuchwa						
0°	5°	0.18"	Roth	x	DO.2390.12	DO.2390.13
-25°	5°	0.18"	Roth	x	DO.2390.14	DO.2390.15
0°	5°	0.22"	Roth	x	DO.2390.22	DO.2390.23
-25°	5°	0.22"	Roth	x	DO.2390.24	DO.2390.25

Buccal tube single non-convertible 1st molar
 Rurka policzkowa pojedyncza niezamienna na pierwszy trzonowiec



Torque/Tork	Offset/Offset dziąsłowy	Slot/Slot	Rx	Headgear slot/Tuba do wyciągu zew	Upper left / Góra lewa	Upper right / Góra prawa
Maxillary / Szczeka						
-10°	8°	0.18"	Roth	x	DO.2380.14	DO.2380.15
-10°	8°	0.22"	Roth	x	DO.2380.24	DO.2380.25
Mandibular / Żuchwa						
-25°	5°	0.18"	Roth	x	DO.2390.14	DO.2390.15
-25°	5°	0.22"	Roth	x	DO.2390.24	DO.2390.25

Buccal double non-convertible, occlusal headgear tube 1st molar
 Rurka policzkowa podwójna niezamienna z tubą do wyciągu zewnętrznego od strony płaszczyzny zgryzowej



Torque/Tork	Offset/Offset dziąsłowy	Slot/Slot	Rx	Headgear slot/Tuba do wyciągu zew	Upper left / Góra lewa	Upper right / Góra prawa
Maxillary / Szczeka						
0°	0°	0.18"	Roth	x	DO.2383.10	DO.2383.11
-10°	8°	0.18"	Roth	x	DO.2383.14	DO.2383.15
0°	0°	0.22"	Roth	x	DO.2383.20	DO.2383.21
-10°	8°	0.22"	Roth	x	DO.2383.24	DO.2383.25

Mini buccal tubes bondable

Rurki mini do przyklejania

Specially designed for partially erupted 2nd molars
 Zaprojektowane dla częściowo wyrżniętych drugich trzonowców



Torque/Tork	Offset/Offset dziąsłowy	Rx	Slot/Slot	Slot/Slot
			0.18"	0.22"
0°	0°	Roth	UL / LR	DO.2381.10
0°	0°	Roth	UR / LL	DO.2381.11
-10°	0°	Roth	UR	DO.2381.12
-10°	0°	Roth	UL	DO.2381.13
			0.18"	0.22"
0°	0°	Roth	UR / LL	DO.2381.11
-25°	0°	Roth	UL / LR	DO.2381.10
0°	0°	Roth	LR	DO.2391.13
-25°	0°	Roth	LL	DO.2391.12

Sure-Fit

1st and 2nd premolar / bicuspid bands plain / Pierścienie gładkie na przedtrzonowce

Anatomically shaped / Anatomiczny kształt pierścienia
Fast, placement and accurate fit
Umożliwia szybkie umiejscowienie i dokładne jego dopasowanie

Rounded edges / Zawinięte brzegi
No sharp edges for patient comfort
Gładko wykończone krawędzie zapewniają maksymalny komfort pacjenta



Micro-Etched interior surface / Mikrowytrawiona wewnętrzna powierzchnia
For increased bond strength
Zapewnia maksymalne utrzymanie

Ideally hardened stainless steel, for easy contouring
Doskonale zahartowany materiał, z którego wykonane są pierścienie ułatwia dopasowanie obwodu pierścienia do zęba

Permanent laser marking / Trwałe laserowe oznakowanie
For easy identification
Zapewnia łatwą identyfikację

each / sztuka



FDI 14,15 24,25

5,4 4,5

each / sztuka



5,4 4,5

FDI 34, 35 44, 45

No.	Size Rozmiar	Upper left, right Góra lewa, prawa
1	22.7	DO.2103.01
2	23.1	DO.2103.02
3	23.4	DO.2103.03
4	23.7	DO.2103.04
5	24.3	DO.2103.05
6	24.7	DO.2103.06
7	24.9	DO.2103.07
8	25.4	DO.2103.08
9	25.7	DO.2103.09
10	26.2	DO.2103.10
11	26.5	DO.2103.11
12	26.9	DO.2103.12
13	27.2	DO.2103.13
14	27.6	DO.2103.14
15	27.9	DO.2103.15
16	28.2	DO.2103.16
17	28.8	DO.2103.17
18	29.4	DO.2103.18
19	29.7	DO.2103.19
20	30.0	DO.2103.20
21	30.4	DO.2103.21
22	30.8	DO.2103.22
23	31.1	DO.2103.23
24	31.5	DO.2103.24
25	31.8	DO.2103.25
26	32.1	DO.2103.26
27	32.4	DO.2103.27
28	32.8	DO.2103.28

Upper 1st and 2nd premolars / bicuspid
Do zębów przedtrzonowych górnych pierwszych i drugich

No.	Size Rozmiar	Lower left, right Dół lewy, prawy
3	21.2	DO.2123.03
4	21.4	DO.2123.04
5	21.8	DO.2123.05
6	22.4	DO.2123.06
7	23.0	DO.2123.07
8	23.3	DO.2123.08
9	23.7	DO.2123.09
10	24.2	DO.2123.10
11	24.6	DO.2123.11
12	25.4	DO.2123.12
13	25.8	DO.2123.13
14	26.1	DO.2123.14
15	26.4	DO.2123.15
16	26.8	DO.2123.16
17	27.3	DO.2123.17
18	27.8	DO.2123.18
19	28.2	DO.2123.19
20	28.7	DO.2123.20
21	29.1	DO.2123.21
22	29.5	DO.2123.22
23	30.1	DO.2123.23
24	30.5	DO.2123.24
25	30.8	DO.2123.25
26	31.2	DO.2123.26

Lower 1st and 2nd premolars / bicuspid
Do zębów przedtrzonowych dolnych pierwszych i drugich

Sure-Fit

1st and 2nd premolar / bicuspid bands with weldable brackets / Pierścienie z zamkiem na przedtrzonowce

each / sztuka

Anatomically shaped / Anatomiczny kształt pierścienia

Fast, placement and accurate fit
Umożliwia szybkie umiejscowienie i dokładne jego dopasowanie

Rounded edges / Zawinięte brzegi

No sharp edges for patient comfort
Gładko wykończone krawędzie zapewniają maksymalny komfort pacjenta



Micro-Etched interior surface / Mikrowytrawiona wewnętrzna powierzchnia

For increased bond strength
Zapewnia maksymalne utrzymanie

Ideally hardened stainless steel, for easy contouring

Doskonale zahartowanie materiału, z którego wykonane są pierścienie ułatwia dopasowanie obwodu pierścienia do zęba

Permanent laser marking / Trwałe laserowe oznakowanie

For easy identification
Zapewnia łatwą identyfikację

With weldable bracket
without hook .Roth 022*
z zamkiem bez haczyk Roth .022*



each / sztuka



FDI 14,15 24,25
5,4 4,5

With weldable bracket
without hook .Roth 022*
z zamkiem bez haczyk Roth .022*



each / sztuka



FDI 34, 35 44, 45
5,4 4,5

No.	Size Rozmiar	Upper left Góra lewa	Upper right Góra prawa
1	22.7	DO.2104.01	DO.2105.01
2	23.1	DO.2104.02	DO.2105.02
3	23.4	DO.2104.03	DO.2105.03
4	23.7	DO.2104.04	DO.2105.04
5	24.3	DO.2103.05	DO.2105.05
6	24.7	DO.2104.06	DO.2105.06
7	24.9	DO.2104.07	DO.2105.07
8	25.4	DO.2104.08	DO.2105.08
9	25.7	DO.2104.09	DO.2105.09
10	26.2	DO.2104.10	DO.2105.10
11	26.5	DO.2104.11	DO.2105.11
12	26.9	DO.2104.12	DO.2105.12
13	27.2	DO.2104.13	DO.2105.13
14	27.6	DO.2104.14	DO.2105.14
15	27.9	DO.2104.15	DO.2105.15
16	28.2	DO.2104.16	DO.2105.16
17	28.8	DO.2104.17	DO.2105.17
18	29.4	DO.2104.18	DO.2105.18
19	29.7	DO.2104.19	DO.2105.19
20	30.0	DO.2104.20	DO.2105.20
21	30.4	DO.2104.21	DO.2105.21
22	30.8	DO.2104.22	DO.2105.22
23	31.1	DO.2104.23	DO.2105.23
24	31.5	DO.2104.24	DO.2105.24
25	31.8	DO.2104.25	DO.2105.25
26	32.1	DO.2104.26	DO.2105.26
27	32.4	DO.2104.27	DO.2105.27
28	32.8	DO.2104.28	DO.2105.28

No.	Size Rozmiar	Lower left Dół lewy	Lower right Dół prawy
3	21.2	DO.2124.03	DO.2125.03
4	21.4	DO.2124.04	DO.2125.04
5	21.8	DO.2124.05	DO.2125.05
6	22.4	DO.2124.06	DO.2125.06
7	23.0	DO.2124.07	DO.2125.07
8	23.3	DO.2124.08	DO.2125.08
9	23.7	DO.2124.09	DO.2125.09
10	24.2	DO.2120.10	DO.2125.10
11	24.6	DO.2124.11	DO.2125.11
12	25.4	DO.2124.12	DO.2125.12
13	25.8	DO.2124.13	DO.2125.13
14	26.1	DO.2124.14	DO.2125.14
15	26.4	DO.2124.15	DO.2125.15
16	26.8	DO.2124.16	DO.2125.16
17	27.3	DO.2124.17	DO.2125.17
18	27.8	DO.2124.18	DO.2125.18
19	28.2	DO.2124.19	DO.2125.19
20	28.7	DO.2124.20	DO.2125.20
21	29.1	DO.2124.21	DO.2125.21
22	29.5	DO.2124.22	DO.2125.22
23	30.1	DO.2124.23	DO.2125.23
24	30.5	DO.2124.24	DO.2125.24
25	30.8	DO.2124.25	DO.2125.25
26	31.2	DO.2124.26	DO.2125.26

Lower 1st and 2nd premolars / bicuspid

Do zębów przedtrzonowych dolnych pierwszych i drugich

Upper 1st and 2nd premolars / bicuspid

Do zębów przedtrzonowych górnych pierwszych i drugich

Brackets weldable for premolar bands
Zamki do zgrzewania z pierścieniami na przedtrzonowce



Pack of 10 pieces
Opak. 10 szt.

Roth .022"	1st premolar Pierwsze przedtrzonowce	2nd premolar Drugie przedtrzonowce
Upper right / Góra prawa	DO.2410.01	DO.2410.03
Upper left / Góra lewa	DO.2410.02	DO.2410.04
Lower right / Dół prawy	DO.2411.01	DO.2411.03
Lower left / Dół 4 lewy	DO.2411.02	DO.2411.04

Lingual cleat weldable for premolar bands
Klił językowy do zgrzewania z pierścieniami na trzonowce



Pack of 10 pieces
Opak. 10 szt.

DO.2441.20

Weldable accessories for molar bands / Akcesoria do zgrzewania z pierścieniami na trzonowce

Lingual cleats / Kliły językowe



DO.2441.01

Pack of 10 pieces
Opak. 10 szt.



DO.2441.02

Lingual buttons / Guziczki językowe



DO.2424.01
Round / Okrągłe



DO.2423.02
Oval / Owalne

Pack of 10 pieces
Opak. 10 szt.

Lingual sheaths / Rurki językowe

Pack of 10 pieces
Opak. 10 szt.



DO.2430.01

Pack of 10 pieces
Opak. 10 szt.



DO.2432.01
Upper left / Lower right
Góra lewa/ Dół prawy

Pack of 10 pieces
Opak. 10 szt.



DO.2432.02
Upper right / Lower left
Góra prawa / Dół lewy

Bondable accessories / Akcesoria do przyklejania

Lingual buttons / Guziczki językowe



DO.2420.01
Round / Okrągłe



DO.2420.02
Round perforated base
Podstawa perforowana



DO.2420.03
Round / Okrągłe

Pack of 10 pieces
Opak. 10 szt.



DO.2421.02
Oval / Owalne



DO.2421.01
Oval / Owalne
Curved base



DO.2421.03
Oval / Owalne
Flat base



DO.2420.04
Round / Okrągłe

Lingual buttons composite
Guziczki językowe kompozytowe

Pack of 4 pieces
Opak. 4 szt.



DO.2425.01

Lingual buttons ceramic
Guziczki językowe ceramiczne

Pack of 4 pieces
Opak. 4 szt.



DO.2425.02

Lingual cleats
Klity językowe

Pack of 10 pieces
Opak. 10 szt.



DO.2442.01

Lingual pulling rings
Guziczki językowe do ekstruzji z oczkiem

Pack of 10 pieces
Opak. 10 szt.



DO.2450.03
Round / Okrągłe

Eyelet
Zaczep oczkowy

Pack of 10 pieces
Opak. 10 szt.



DO.2450.01

Pack of 10 pieces
Opak. 10 szt.



DO.2450.02

Aesthetic eyelet
Zaczep oczkowy

Pack of 10 piece
Opak. 10 szt.



DO.2450.05
Ceramic / Ceramiczne

Pack of 10 pieces
Opak. 10 szt.



DO.2450.04
Composite / kompozytowe

Bicuspid bondable tube with hook



Maxillary / Szczęka					
Torque/Tork	Offset/Offset dziąsłowy	Slot/Slot	Rx	Upper left / Góra lewa	Upper right / Góra prawa
-7°	0°	0.22"	Roth	DO.2460.02	DO.2460.01
Mandibular / Żuchwa					
Torque/Tork	Offset/Offset dziąsłowy	Slot/Slot	Rx	Lower left / Dół lewa	Lower right / Dół prawa
-20°	0°	0.22"	Roth	DO.2461.02	DO.2461.01

Eruption appliance
Akcesoria do wprowadzania zatrzymanych zębów do łuku

each / sztuka



DO.2455.01
Round eyelet with chain silver
Guziczek z łańcuszkiem srebrny, okrągła podstawa



DO.2455.02
Round eyelet with chain gold plated
Guziczek z łańcuszkiem złoty, okrągła podstawa

each / sztuka



DO.2455.11
Rectangular eyelet with chain silver
Guziczek z łańcuszkiem srebrny, prostokątna podstawa



DO.2455.12
Rectangular eyelet with chain gold plated
Guziczek z łańcuszkiem złoty, prostokątna podstawa

MaxiFlex™

Super elastic nickel titanium archwires / Łuki Niklowo-Tytanowe

Superelastic 1 (SE1) wire rounds out austenitic Nickel Titanium wire line. The moderate, consistent forces exhibited by SE1 wire provide a great avenue for early to mid-stage treatment. It provides slightly less force than our Black-Ti wire, and is fully austenitic at room temperature. Due to its high flexibility and resiliency, Superelastic 1 wire recovers beautifully from bends and deformation of angles up to 45°, and even up to 75° in some cases!

- Moderate, consistent force • Greater patient comfort than over a long activation period, with Stainless Steel wires.
- Excellent resiliency. • Highly flexible.
- Responsive to chilling. • Af of 45-60° F (7.2-15.6°C).
- Square and Rectangle wires offer ability to simultaneously level and add torque and rotation earlier in treatment. More efficient than treatment with Stainless Steel.

Pack of 10 pieces / Opak. 10 szt.

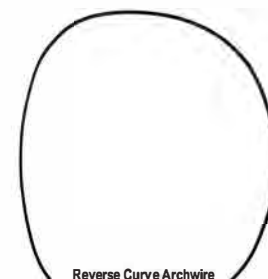
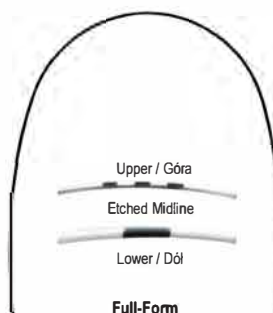
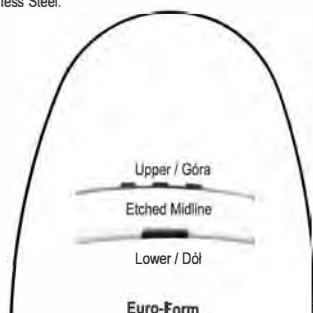

Round / okrągłe	Upper / Góra	Lower / Dół	Upper / Góra	Lower / Dół	Upper / Góra	Lower / Dół
○						
.012"	DO.3100.12	DO.3101.12	DO.3110.12	DO.3111.12	DO.3300.12	DO.3301.12
.014"	DO.3100.14	DO.3101.14	DO.3110.14	DO.3111.14	DO.3300.14	DO.3301.14
.016"	DO.3100.16	DO.3101.16	DO.3110.16	DO.3111.16	DO.3300.16	DO.3301.16
.018"	DO.3100.18	DO.3101.18	DO.3110.18	DO.3111.18	DO.3300.18	DO.3301.18
.020"	DO.3100.20	DO.3101.20	DO.3110.20	DO.3111.20	DO.3300.20	DO.3301.20
Square / kwadratowe	Upper / Góra	Lower / Dół	Upper / Góra	Lower / Dół	Upper / Góra	Lower / Dół
□						
.016" x .016"	DO.3102.16	DO.3103.16	DO.3112.16	DO.3113.16	DO.3302.16	DO.3303.16
.018" x .018"	DO.3102.18	DO.3103.18	DO.3112.18	DO.3113.18	DO.3302.18	DO.3303.18
Rectangle / prostokątne	Upper / Góra	Lower / Dół	Upper / Góra	Lower / Dół	Upper / Góra	Lower / Dół
▭						
.016" x .022"	DO.3104.62	DO.3107.62	DO.3114.62	DO.3117.62	DO.3304.62	DO.3307.62
.017" x .025"	DO.3104.75	DO.3107.75	DO.3114.75	DO.3117.75	DO.3304.75	DO.3307.75
.018" x .025"	DO.3104.85	DO.3107.85	DO.3114.85	DO.3117.85	DO.3304.85	DO.3307.85
.019" x .025"	DO.3104.95	DO.3107.95	DO.3114.95	DO.3117.95	DO.3304.95	DO.3307.95
.021" x .025"	DO.3105.15	DO.3108.15	DO.3115.15	DO.3118.15	DO.3305.15	DO.3308.15

Dentalline®

orthodontic products

Super elastic nickel titanium archwires / Łuki Niklowo-Tytanowe

High quality wires

Individually packed in sterilization pouch to protect against cross infection, non-sterile.

Wysokiej jakości łuki

Pakowane osobno w torebki sterylizacyjne, aby uniknąć zakażeń, niesterylne.

Pack of 10 pieces / Opak. 10 szt.

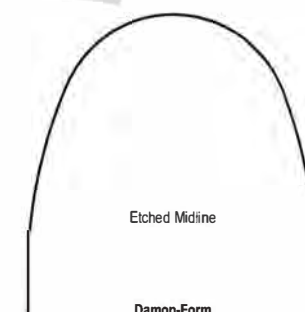
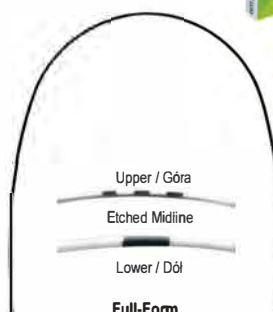
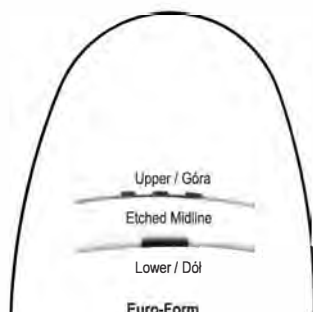

Round / okrągłe	Upper / Góra	Lower / Dół	Upper / Góra	Lower / Dół	Round / okrągłe	Universal / Uniwersalne
○					○	
.010"	DL300000-E	DL300037-E	DL300000	DL300037	.010"	DL300200
.012"	DL300001-E	DL300007-E	DL300001	DL300007	.012"	DL300201
.013"	DL300002-E	DL300008-E	DL300002	DL300008	.013"	DL300202
.014"	DL300003-E	DL300009-E	DL300003	DL300009	.014"	DL300203
.016"	DL300004-E	DL300010-E	DL300004	DL300010	.016"	DL300204
.018"	DL300005-E	DL300011-E	DL300005	DL300011	.018"	DL300205
.020"	DL300006-E	DL300012-E	DL300006	DL300012	.020"	DL300206

Super elastic nickel titanium archwires / Łuki Niklowo-Tytanowe

High quality wires

Individually packed in sterilization pouch to protect against cross infection, non-sterile.

Wysokiej jakości łuki

Pakowane osobno w torebki sterylizacyjne, aby uniknąć zakażeń, niesterylne.

Pack of 10 pieces / Opak. 10 szt.

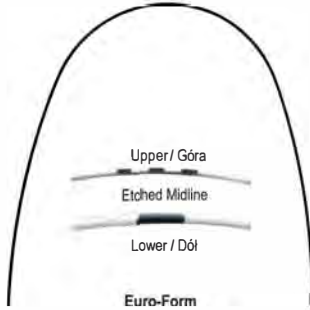

Euro-Form

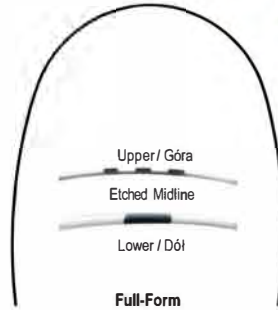

Full-Form

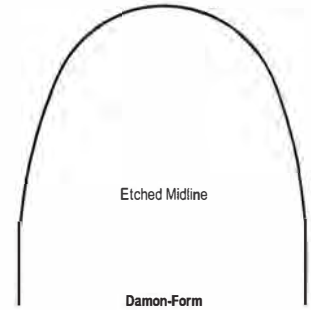

Damon-Form

Rectangle / prostokątne

	Upper / Góra	Lower / Dół	Upper / Góra	Lower / Dół
.014" x .025"	DL300013-E	DL300025-E	DL300013	DL300025
.016" x .022"	DL300015-E	DL300027-E	DL300015	DL300027
.016" x .025"	DL300016-E	DL300028-E	DL300016	DL300028
.017" x .022"	DL300017-E	DL300029-E	DL300017	DL300029
.017" x .025"	DL300018-E	DL300030-E	DL300018	DL300030
.018" x .022"	DL300020-E	DL300032-E	DL300020	DL300032
.018" x .025"	DL300021-E	DL300033-E	DL300021	DL300033
.019" x .025"	DL300022-E	DL300034-E	DL300022	DL300034
.021" x .025"	DL300024-E	DL300036-E	DL300024	DL300036

Rectangle / prostokątne

	Universal / Uniwersalne
.014" x .025"	DL300213
.016" x .022"	DL300215
.016" x .025"	DL300216
.017" x .022"	DL300217
.017" x .025"	DL300218
.018" x .022"	DL300220
.018" x .025"	DL300221
.019" x .025"	DL300222
.021" x .025"	DL300224

Square / kwadratowe

	Upper / Góra	Lower / Dół	Upper / Góra	Lower / Dół
.016" x .016"	DL300014-E	DL300026-E	DL300014	DL300026
.018" x .018"	DL300019-E	DL300031-E	DL300019	DL300031
.020" x .020"	DL300023-E	DL300035-E	DL300023	DL300035

Square / kwadratowe

	Universal / Uniwersalne
.016" x .016"	DL300214
.018" x .018"	DL300219
.020" x .020"	DL300223

Pack of 10 pieces / Opak. 10 szt.

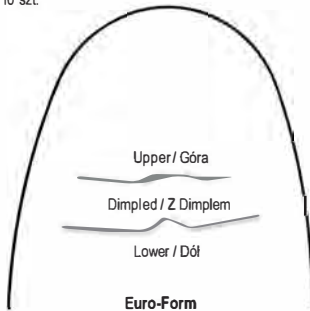

Euro-Form

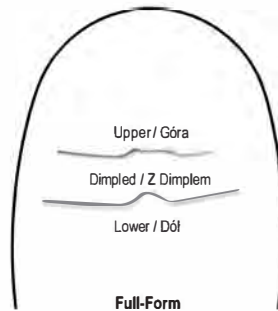

Full-Form

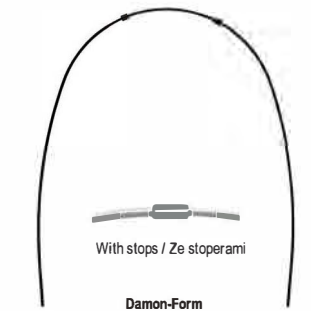

Damon-Form

Round / okrągłe

	Upper / Góra	Lower / Dół	Upper / Góra	Lower / Dół
.010"	DL300038-E	DL300039-E	DL300038	DL300039
.012"	DL300040-E	DL300046-E	DL300040	DL300046
.013"	DL300041-E	DL300047-E	DL300041	DL300047
.014"	DL300042-E	DL300048-E	DL300042	DL300048
.016"	DL300043-E	DL300049-E	DL300043	DL300049
.018"	DL300044-E	DL300050-E	DL300044	DL300050
.020"	DL300045-E	DL300051-E	DL300045	DL300051

Round / okrągłe

	Universal / Uniwersalne
.012"	DL300240
.013"	DL300241
.014"	DL300242
.016"	DL300243
.018"	DL300244
.020"	DL300245

Rectangle / prostokątne

	Upper / Góra	Lower / Dół	Upper / Góra	Lower / Dół
.014" x .025"	DL300052-E	DL300064-E	DL300052	DL300064
.016" x .022"	DL300054-E	DL300066-E	DL300054	DL300066
.016" x .025"	DL300055-E	DL300067-E	DL300055	DL300067
.017" x .022"	DL300056-E	DL300068-E	DL300056	DL300068
.017" x .025"	DL300057-E	DL300069-E	DL300057	DL300069
.018" x .022"	DL300059-E	DL300071-E	DL300059	DL300071
.018" x .025"	DL300060-E	DL300072-E	DL300060	DL300072
.019" x .025"	DL300061-E	DL300073-E	DL300061	DL300073
.021" x .025"	DL300063-E	DL300075-E	DL300063	DL300075

Rectangle / prostokątne

	Universal / Uniwersalne
.014" x .025"	DL300252
.016" x .022"	DL300254
.016" x .025"	DL300255
.017" x .022"	DL300256
.017" x .025"	DL300257
.018" x .022"	DL300259
.018" x .025"	DL300260
.019" x .025"	DL300261
.021" x .025"	DL300263

Square / kwadratowe

	Upper / Góra	Lower / Dół	Upper / Góra	Lower / Dół
.016" x .016"	DL300053-E	DL300065-E	DL300053	DL300065
.018" x .018"	DL300058-E	DL300070-E	DL300058	DL300070
.020" x .020"	DL300062-E	DL300074-E	DL300062	DL300074

Square / kwadratowe

	Universal / Uniwersalne
.016" x .016"	DL300253
.018" x .018"	DL300258
.020" x .020"	DL300262

Invisi-Flex™

Tooth-Tone nickel titanium archwires / Łuki Niklowo-Tytanowe kosmetyczne



The same great features as our TruFlex Nickel Titanium archwires with a durable tooth colored overcoat which offers superior aesthetics, stain resistance, and low friction. Size shown is finished size. Tooth Tone coating adds .002" thickness to diameter

Opdome na przebarwienia łuki powlekane Tooth Tone zapewniają dużą estetykę oraz niskie tarcie. Rozmiar łuku zawiera pokrycie o grubości .002"

Pack of 2 pieces / Opak. 2 szt.



Round / okrągłe	Upper / Góra	Lower / Dół	Upper / Góra	Lower / Dół
○				
.014"	DO.3800.14	DO.3801.14	DO.3880.14	DO.3881.14
.016"	DO.3800.16	DO.3801.16	DO.3880.16	DO.3881.16
.018"	DO.3800.18	DO.3801.18	DO.3880.18	DO.3881.18
.020"	DO.3800.20	DO.3801.20	DO.3880.20	DO.3881.20

Square / kwadratowe	Upper / Góra	Lower / Dół	Upper / Góra	Lower / Dół
□				
.018" x .018"	DO.3802.18	DO.3803.18	DO.3882.18	DO.3883.18
.020" x .020"	DO.3802.20	DO.3803.20		

Rectangle / prostokątne	Upper / Góra	Lower / Dół	Upper / Góra	Lower / Dół
▭				
.016" x .022"	DO.3804.62	DO.3807.62		
.018" x .024"	DO.3804.84	DO.3807.84	DO.3884.84	DO.3887.84
.019" x .027"	DO.3804.97	DO.3807.97		
.021" x .027"	DO.3805.17	DO.3808.17		

SANI-PAK

Aesthetic Micro-Coated Archwires
Łuki estetyczne pokryte mikro-warstwą

The perfect combination of aesthetics and functionality Micro coating is only done on labial surface of archwire to reduce friction and improve sliding mechanics compared to fully coated wire.

True archwire size because coating is only .0005" thick compared to .002" of competitive brands.

The coating is resistant to staining and cracking even if the archwire shape is changed.

All Micro-Coated Archwires are individually packaged & sealed in an autoclavable pack to protect your patients from cross infection.

Doskonałe połączenie estetyki i funkcjonalności. Łuki pokryte mikro-warstwą, mikro tylko od strony wargowej, redukują tarcie oraz zapewniają swobodniejsze umieszczenie łuku niż tradycyjne łuki powlekane.

"Prawdziwy" rozmiar łuku ponieważ pokrycie wynosi .0005" w porównaniu do innych łuków, których pokrycie wynosi .002"

Pokrycie jest odporne na plamy i zadrapania, nawet gdy kształt łuku ulegnie zmianie.

Wszystkie łuki pokryte mikro-warstwą są pakowane osobno, niesterylne.



Invisi-Flex™ Micro Coated

Tooth-Tone micro coated NiTi archwires
Łuki NiTi kosmetyczne pokryte mikro-warstwą

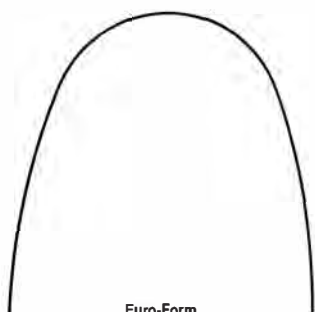

Round / okrągłe	Each / Sztuka	
○	Upper / Góra	Lower / Dół
.012"	DO.3820.12	DO.3821.12
.014"	DO.3820.14	DO.3821.14
.016"	DO.3820.16	DO.3821.16
.018"	DO.3820.18	DO.3821.18
.020"	DO.3820.20	DO.3821.20
Square / kwadratowe	Upper / Góra	Lower / Dół
□		
.016" x .016"	DO.3822.16	DO.3823.16
Rectangle / prostokątne	Upper / Góra	Lower / Dół
▭		
.016" x .022"	DO.3824.62	DO.3827.62
.017" x .025"	DO.3824.75	DO.3827.75
.018" x .025"	DO.3824.85	DO.3827.85
.019" x .025"	DO.3824.95	DO.3827.95
.021" x .025"	DO.3825.15	DO.3828.15



Pre-Torqued NiTi archwires / Łuki NiTi torujące

Pack of 10 pieces
Opak. 10 szt.

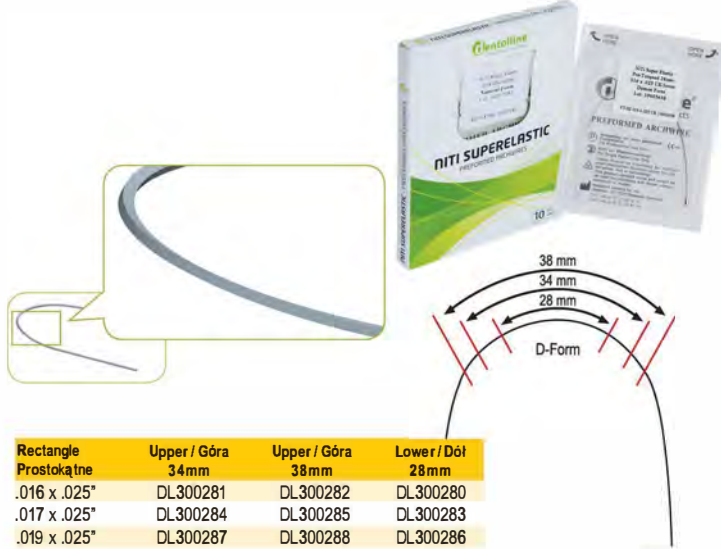

Rectangle Prostokątne	Upper / Góra 34mm	Upper / Góra 38mm	Lower / Dół 28mm
.016 x .025"	DL300281	DL300282	DL300280
.017 x .025"	DL300284	DL300285	DL300283
.019 x .025"	DL300287	DL300288	DL300286

MaxiFlex™

Super elastic nickel titanium wires / Drut Niklowo-Tytanowy na szpuli

- Posiada zalety produktów niklowo - tytanowych
- Siła, delikatna siła
- Jest bardzo elastyczny i sprężysty



15" na szpuli (381mm)

○	Round / okrągły	
.012"		DO.3486.12
.014"		DO.3486.14
.016"		DO.3486.16
.018"		DO.3486.18
.020"		DO.3486.20

TempFlex™

Thermal nickel titanium archwires / Łuki Niklowo-Tytanowe termalne



Thermal is a heat-activated (thermal) wire specifically designed for consistent Af performance and low tooth-moving forces. Thermal wire provides outstanding resiliency and exhibits true thermal performance. Soft at room temperature and in the doctor's hand, Advanced Thermal allows easy ligation. Outstanding shape integrity.

Specially designed wire for consistent Af performance. Every production lot of Advanced Thermal wires is water bath tested to verify Af of 80-90°F (26.7-32.2°C). Soft at room temperature; very easy to ligate. Great resiliency. Ideal for significant crowding cases. Gentle forces provide for greater patient comfort. Very responsive to chilling. Square and Rectangle wire sizes provide low, consistent toothmoving forces to address torque control early in treatment

Charakteryzuje działanie stałej i zarazem niewielkiej siły. Łuki są giętkie w temperaturze pokojowej oraz posiadają elastyczne właściwości pod wpływem temperatury ciała. Doskonale sprawdzają się w początkowej fazie leczenia. Wyróżnia je gładkie i błyszczące wykończenie.

Dostępne w wersjach full form i euro. Pakowane po 10 sztuk. ent toothmoving forces to address torque control early in treatment

Pack of 10 pieces / Opak. 10 szt.

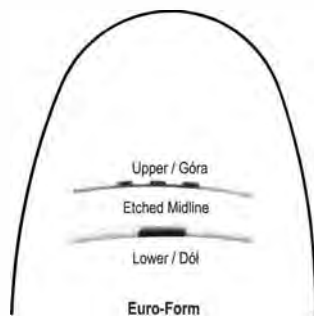

Euro-Form

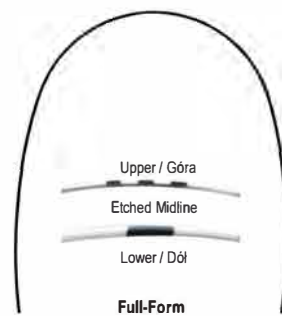

Full-Form

○	Upper / Góra	Lower / Dół	Upper / Góra	Lower / Dół
.014"	DO.3600.14	DO.3601.14	DO.3610.14	DO.3611.14
.016"	DO.3600.16	DO.3601.16	DO.3610.16	DO.3611.16
.018"	DO.3600.18	DO.3601.18	DO.3610.18	DO.3611.18
.020"	DO.3600.20	DO.3601.20	DO.3610.20	DO.3611.20

□	Upper / Góra	Lower / Dół	Upper / Góra	Lower / Dół
.016" x .016"	DO.3602.16	DO.3603.16	DO.3612.16	DO.3613.16
.018" x .018"	DO.3602.18	DO.3603.18	DO.3612.18	DO.3613.18

□	Upper / Góra	Lower / Dół	Upper / Góra	Lower / Dół
.016" x .022"	DO.3604.62	DO.3607.62	DO.3614.62	DO.3617.62
.017" x .025"	DO.3604.75	DO.3607.75	DO.3614.75	DO.3617.75
.018" x .025"	DO.3604.85	DO.3607.85	DO.3614.85	DO.3617.85
.019" x .025"	DO.3604.95	DO.3607.95	DO.3614.95	DO.3617.95
.021" x .025"	DO.3605.15	DO.3608.15	DO.3615.15	DO.3618.15



Pack of 10 pieces / Opak. 10 szt.

High quality wires

Individually packed in sterilization pouch to protect against cross infection, non-sterile.

Wysokiej jakości łuki

Pakowane osobno w torebki sterylizacyjne, aby uniknąć zakażeń, niesterylne.

Thermal nickel titanium archwires / Łuki Niklowo-Tytanowe termalne

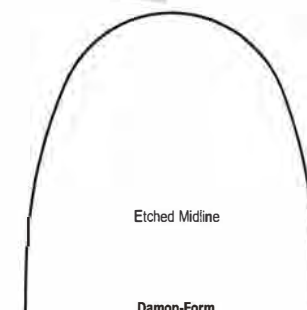
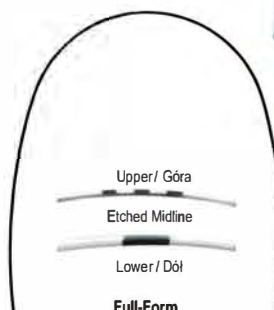
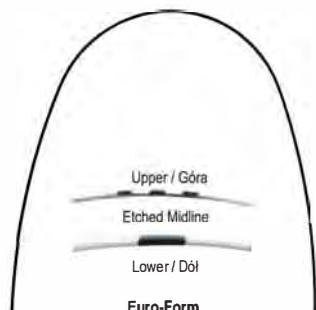

Round / okrągłe

	Upper / Góra	Lower / Dół	Upper / Góra	Lower / Dół
.010"	DL301000-E	DL301037-E	DL301000	DL301037
.012"	DL301001-E	DL301007-E	DL301001	DL301007
.013"	DL301002-E	DL301008-E	DL301002	DL301008
.014"	DL301003-E	DL301009-E	DL301003	DL301009
.016"	DL301004-E	DL301010-E	DL301004	DL301010
.018"	DL301005-E	DL301011-E	DL301005	DL301011
.020"	DL301006-E	DL301012-E	DL301006	DL301012

Round / okrągłe

	Universal / Uniwersalne
.010"	DL301200
.012"	DL301201
.013"	DL301202
.014"	DL301203
.016"	DL301204
.018"	DL301205
.020"	DL301206

Rectangle / prostokątne

	Upper / Góra	Lower / Dół	Upper / Góra	Lower / Dół
.014" x .025"	DL301013-E	DL301025-E	DL301013	DL301025
.016" x .022"	DL301015-E	DL301027-E	DL301015	DL301027
.016" x .025"	DL301016-E	DL301028-E	DL301016	DL301028
.017" x .022"	DL301017-E	DL301029-E	DL301017	DL301029
.017" x .025"	DL301018-E	DL301030-E	DL301018	DL301030
.018" x .022"	DL301020-E	DL301032-E	DL301020	DL301032
.018" x .025"	DL301021-E	DL301033-E	DL301021	DL301033
.019" x .025"	DL301022-E	DL301034-E	DL301022	DL301034
.021" x .025"	DL301024-E	DL301036-E	DL301024	DL301036

Rectangle / prostokątne

	Universal / Uniwersalne
.014" x .025"	DL301213
.016" x .022"	DL301215
.016" x .025"	DL301216
.017" x .022"	DL301217
.017" x .025"	DL301218
.018" x .022"	DL301220
.018" x .025"	DL301221
.019" x .025"	DL301222
.021" x .025"	DL301224

Square / kwadratowe

	Upper / Góra	Lower / Dół	Upper / Góra	Lower / Dół
.016" x .016"	DL301014-E	DL301026-E	DL301014	DL301026
.018" x .018"	DL301019-E	DL301031-E	DL301019	DL301031
.020" x .020"	DL301023-E	DL301035-E	DL301023	DL301035

Square / kwadratowe

	Universal / Uniwersalne
.016" x .016"	DL301214
.018" x .018"	DL301219
.020" x .020"	DL301223

Pack of 10 pieces / Opak. 10 szt.

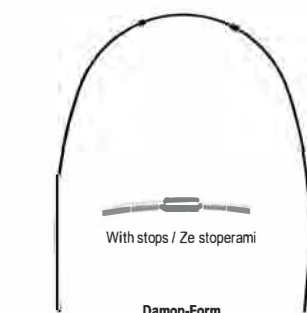
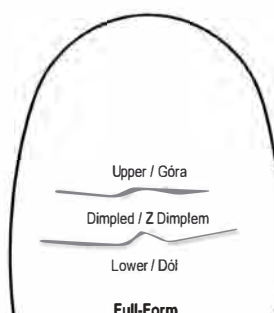
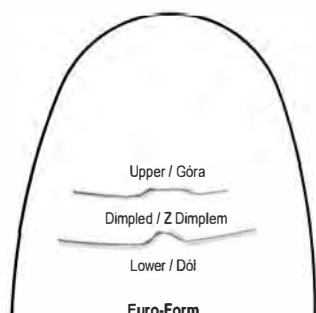

Round / okrągłe

	Upper / Góra	Lower / Dół	Upper / Góra	Lower / Dół
.010"	DL301038-E	DL301039-E	DL301038	DL301039
.012"	DL301040-E	DL301046-E	DL301040	DL301046
.013"	DL301041-E	DL301047-E	DL301041	DL301047
.014"	DL301042-E	DL301048-E	DL301042	DL301048
.016"	DL301043-E	DL301049-E	DL301043	DL301049
.018"	DL301044-E	DL301050-E	DL301044	DL301050
.020"	DL301045-E	DL301051-E	DL301045	DL301051

Round / okrągłe

	Universal / Uniwersalne
.012"	DL301240
.013"	DL301241
.014"	DL301242
.016"	DL301243
.018"	DL301244
.020"	DL301245

Thermal nickel titanium archwires / Łuki Niklowo-Tytanowe termalne

High quality wires
Individually packed in sterilization pouch to protect against cross infection, non-sterile.

Wysokiej jakości łuki

Pakowane osobno w torebki sterylizacyjne, aby uniknąć zakażeń, niesterylne.

Pack of 10 pieces / Opak. 10 szt.

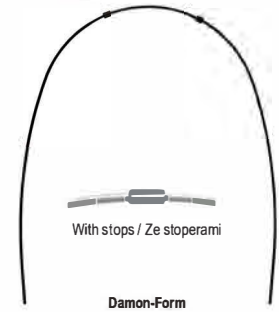
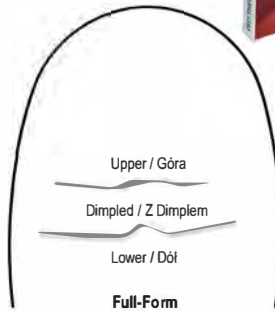
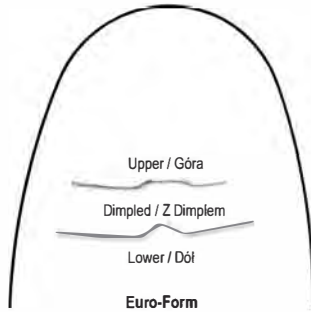

Rectangle / prostokątne

	Upper / Góra	Lower / Dół	Upper / Góra	Lower / Dół
.014" x .025"	DL301052-E	DL301064-E	DL301052	DL301064
.016" x .022"	DL301054-E	DL301066-E	DL301054	DL301066
.016" x .025"	DL301055-E	DL301067-E	DL301055	DL301067
.017" x .022"	DL301056-E	DL301068-E	DL301056	DL301068
.017" x .025"	DL301057-E	DL301069-E	DL301057	DL301069
.018" x .022"	DL301059-E	DL301071-E	DL301059	DL301071
.018" x .025"	DL301060-E	DL301072-E	DL301060	DL301072
.019" x .025"	DL301061-E	DL301073-E	DL301061	DL301073
.021" x .025"	DL301063-E	DL301075-E	DL301063	DL301075

Square / kwadratowe

	Upper / Góra	Lower / Dół	Upper / Góra	Lower / Dół
.016" x .016"	DL301053-E	DL301065-E	DL301053	DL301065
.018" x .018"	DL301058-E	DL301070-E	DL301058	DL301070
.020" x .020"	DL301062-E	DL301074-E	DL301062	DL301074

Rectangle / prostokątne

	Universal / Uniwersalne
.014" x .025"	DL301252
.016" x .022"	DL301254
.016" x .025"	DL301255
.017" x .022"	DL301256
.017" x .025"	DL301257
.018" x .022"	DL301259
.018" x .025"	DL301260
.019" x .025"	DL301261
.021" x .025"	DL301263

Square / kwadratowe

	Universal / Uniwersalne
.016" x .016"	DL301253
.018" x .018"	DL301258
.020" x .020"	DL301262

SANI-PAK

Aesthetic Micro-Coated Archwires
Łuki estetyczne pokryte mikro-warstwą

The perfect combination of aesthetics and functionality
Micro coating is only done on labial surface of archwire to reduce friction and improve sliding mechanics compared to fully coated wire.

True archwire size because coating is only .0005" thick compared to .002" of competitive brands.

The coating is resistant to staining and cracking even if the archwire shape is changed.

All Micro-Coated Archwires are individually packaged & sealed in an autoclavable pack to protect your patients from cross infection.

Doskonale połączenie estetyki i funkcjonalności.

Łuki pokryte mikro-warstwą, mikro tylko od strony wargowej, redukują tarcie oraz zapewniają swobodniejsze umieszczenie łuku niż tradycyjne łuki powlekane.

"Prawdziwy" rozmiar łuku ponieważ pokrycie wynosi .0005" w porównaniu do innych łuków, których pokrycie wynosi .002"

Pokrycie jest odporne na plamy i zdrapania, nawet gdy kształt łuku ulegnie zmianie.

Wszystkie łuki pokryte mikro-warstwą są pakowane osobno, niesterylne.

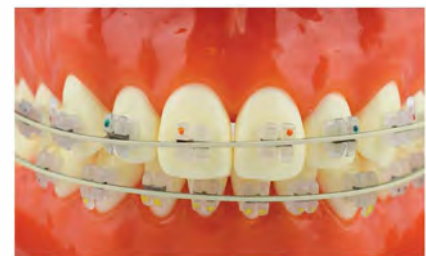

Invisa-Temp™ Micro Coated

Tooth-Tone micro coated NiTi thermal archwires
Łuki NiTi termalne kosmetyczne pokryte mikro-warstwą

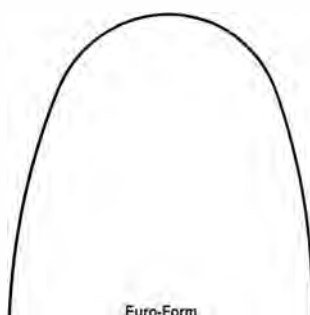

Round / okrągłe	Each / Sztuka	
	Upper / Góra	Lower / Dół
.012"	DO.3900.12	DO.3901.12
.014"	DO.3900.14	DO.3901.14
.016"	DO.3900.16	DO.3901.16
.018"	DO.3900.18	DO.3901.18
.020"	DO.3900.20	DO.3901.20
Square / kwadratowe		
	Upper / Góra	Lower / Dół
.016" x .016"	DO.3902.16	DO.3903.16
Rectangle / prostokątne		
	Upper / Góra	Lower / Dół
.016" x .022"	DO.3904.62	DO.3907.62
.017" x .025"	DO.3904.75	DO.3907.75
.018" x .025"	DO.3904.85	DO.3907.85
.019" x .025"	DO.3904.95	DO.3907.95
.021" x .025"	DO.3905.15	DO.3908.15

UltiMax™

Stainless steel archwires / Łuki stalowe

UltiMax Solid Stainless Steel archwires are produced of high quality medical grade Type 304 VSS material with highly polished surfaces to provide reduced friction between bracket and arch. Their high forces are well-suited for stabilizing positioned teeth during mid- to late stages of treatment. Rectangular wires offer precise torque control for these same stages. Solid Stainless Steel Lengths (14") produced of high quality Type 302SS material have a smooth finish and are available in a wide range of wire sizes for custom appliance fabrication.

- Superior smooth, bright finish.
- Precise shape and flatness of arches is ensured through tight production control.
- Best suited as finishing wire, as forces drop quickly as teeth move.
- Easy bend placement.
- Good corrosion resistance.



Made in USA

Pack of 10 pieces / Opak. 10 szt.

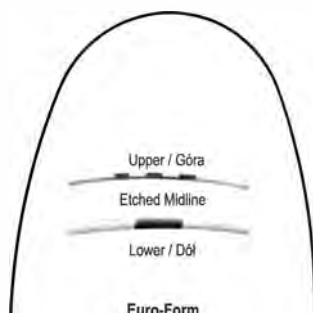

Euro-Form

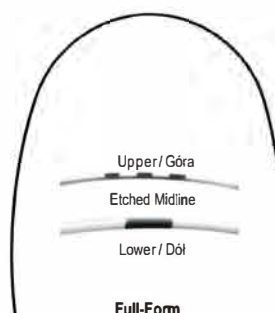

Full-Form

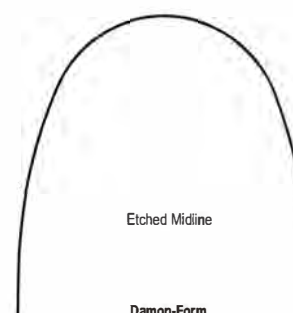

Etched Midline

Damon-Form

Round / okrągłe

	Upper / Góra	Lower / Dół	Upper / Góra	Lower / Dół	Universal / Uniwersalne
.012"	DO.4100.12	DO.4101.12	DO.4110.12	DO.4111.12	DO.4130.12
.014"	DO.4100.14	DO.4101.14	DO.4110.14	DO.4111.14	DO.4130.14
.016"	DO.4100.16	DO.4101.16	DO.4110.16	DO.4111.16	DO.4130.16
.018"	DO.4100.18	DO.4101.18	DO.4110.18	DO.4111.18	DO.4130.18
.020"	DO.4100.20	DO.4101.20	DO.4110.20	DO.4111.20	DO.4130.20

Square / kwadratowe

	Upper / Góra	Lower / Dół	Upper / Góra	Lower / Dół	Universal / Uniwersalne
.016" x .016"	DO.4102.16	DO.4103.16	DO.4112.16	DO.4113.16	DO.4132.16
.018" x .018"	DO.4102.18	DO.4103.18	DO.4112.18	DO.4113.18	DO.4132.16

Rectangle / prostokątne

	Upper / Góra	Lower / Dół	Upper / Góra	Lower / Dół	Universal / Uniwersalne
.016" x .022"	DO.4104.62	DO.4107.62	DO.4114.62	DO.4117.62	DO.4134.62
.017" x .022"	DO.4104.72	DO.4107.72	DO.4114.72	DO.4117.72	DO.4134.72
.017" x .025"	DO.4104.75	DO.4107.75	DO.4114.75	DO.4117.75	DO.4134.75
.018" x .022"	DO.4104.82	DO.4107.82	DO.4114.82	DO.4117.82	DO.4134.82
.018" x .025"	DO.4104.85	DO.4107.85	DO.4114.85	DO.4117.85	DO.4134.85
.019" x .025"	DO.4104.95	DO.4107.95	DO.4114.95	DO.4117.95	DO.4134.95
.021" x .025"	DO.4105.15	DO.4108.15	DO.4115.15	DO.4118.15	DO.4135.15

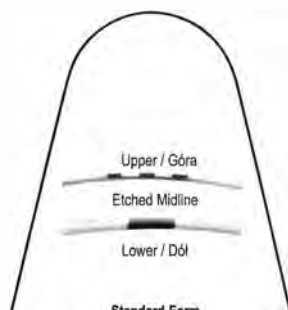

Standard-Form

Pack of 10 pieces / Opak. 10 szt.



Round / okrągłe

	Upper / Góra	Lower / Dół	Square / kwadratowe	Rectangle / prostokątne
.012"	DO.4120.12	DO.4121.12	DO.4122.16	DO.4124.62
.014"	DO.4120.14	DO.4121.14	DO.4122.18	DO.4124.72
.016"	DO.4120.16	DO.4121.16		DO.4124.75
.018"	DO.4120.18	DO.4121.18		DO.4124.82
.020"	DO.4120.20	DO.4121.20		DO.4124.85

Square / kwadratowe

	Upper / Góra	Lower / Dół
	DO.4123.16	DO.4127.62
	DO.4123.18	DO.4127.72
		DO.4127.75
		DO.4127.82
		DO.4127.85

Rectangle / prostokątne

	Upper / Góra	Lower / Dół
	DO.4124.85	DO.4127.85
	DO.4124.95	DO.4127.95
	DO.4125.15	DO.4128.15



Stainless steel archwires / Łuki stalowe

High quality wires

Individually packed in sterilization pouch to protect against cross infection, non-sterile.

Wysokiej jakości łuki

Pakowane osobno w torebki sterylizacyjne, aby uniknąć zakażeń, niesterylne.

Pack of 10 pieces / Opak. 10 szt.



Round / okrągłe

	Upper / Góra	Lower / Dół	Upper / Góra	Lower / Dół
.012"	DL304001-E	DL304006-E	DL304001	DL304006
.014"	DL304002-E	DL304007-E	DL304002	DL304007
.016"	DL304003-E	DL304008-E	DL304003	DL304008
.018"	DL304004-E	DL304009-E	DL304004	DL304009
.020"	DL304005-E	DL304010-E	DL304005	DL304010

Rectangle / prostokątne

	Upper / Góra	Lower / Dół	Upper / Góra	Lower / Dół
.016" x .022"	DL304013-E	DL304025-E	DL304013	DL304025
.017" x .025"	DL304016-E	DL304028-E	DL304016	DL304028
.018" x .025"	DL304018-E	DL304030-E	DL304018	DL304030
.019" x .025"	DL304020-E	DL304032-E	DL304020	DL304032
.021" x .025"	DL304022-E	DL304034-E	DL304022	DL304034

UltiMax Brass Post

Stainless steel brass posted archwires
Łuki ze słupkami

Stainless Steel Retraction Archwires

- Anterior retraction
- Anterior intrusion
- Space closure
- Elastic engagement
- Custom formed to exact measurements
- 304 medical grade Stainless Steel

Słupki łuki rozszerzające ze słupkami są stosowane do:

- Skracania zębów przednich
- Zamykania przestrzeni międzyzębowych
- Cofania zębów przednich
- Produkowane z doskonałej stali medycznej 304v

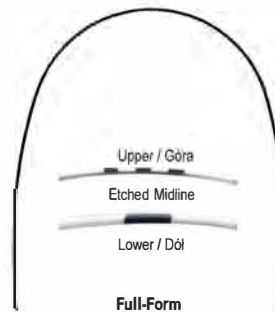

Post or Loop Measurement Measure along incisal edge from distal of lateral to distal of opposite lateral



Rectangle / prostokątne

	.016" x .022"	.017" x .025"	.018" x .025"	.019" x .025"
34 mm	DO.4234.62	DO.4234.75	DO.4234.85	DO.4234.95
36 mm	DO.4236.62	DO.4236.75	DO.4236.85	DO.4236.95
38 mm	DO.4238.62	DO.4238.75	DO.4238.85	DO.4238.95
40 mm	DO.4240.62	DO.4240.75	DO.4240.85	DO.4240.95
42 mm	DO.4242.62	DO.4242.75	DO.4242.85	DO.4242.95

Rectangle / prostokątne

	.016" x .022"	.017" x .025"	.018" x .025"	.019" x .025"
24 mm	DO.4224.62	DO.4224.75	DO.4224.85	DO.4224.95
26 mm	DO.4226.62	DO.4226.75	DO.4226.85	DO.4226.95
28 mm	DO.4228.62	DO.4228.75	DO.4228.85	DO.4228.95
30 mm	DO.4230.62	DO.4230.75	DO.4230.85	DO.4230.95
32 mm	DO.4232.62	DO.4232.75	DO.4232.85	DO.4232.95

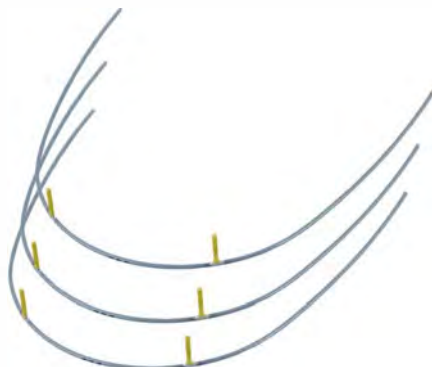

UltiMax 2keyhole

2 keyhole looped archwires
Łuki retrakcyjne z pętlami podwójne

Stainless Steel Retraction Archwires

- Anterior retraction
- Anterior intrusion
- Space closure
- Elastic engagement
- Custom formed to exact measurements
- 304 medical grade Stainless Steel

Stalowe łuki rozwierające 2-Loop są stosowane do:

- Skracania zębów przednich
- Zamykania przestrzeni międzyzębowych
- Cofania zębów przednich
- Produkowane z doskonałej stali medycznej 304v

Post or Loop Measurement Measure along incisal edge from distal of lateral to distal of opposite lateral

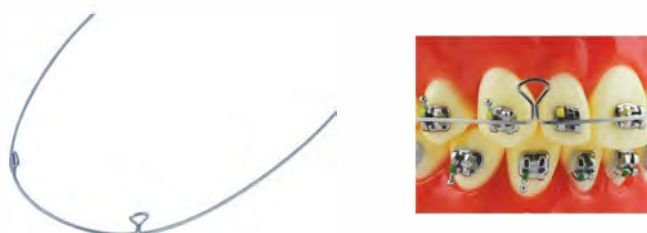

Rectangle / prostokątne	Upper / Góra	Upper / Góra	Upper / Góra
<input type="checkbox"/>	.016" x .022"	.017" x .025"	.019" x .025"
34 mm	DO.4334.62	DO.4334.75	DO.4334.95
36 mm	DO.4336.62	DO.4336.75	DO.4336.95
38 mm	DO.4338.62	DO.4338.75	DO.4338.95
40 mm	DO.4340.62	DO.4340.75	DO.4340.95
42 mm	DO.4342.62	DO.4342.75	DO.4342.95

Rectangle / prostokątne	Lower / Dół	Lower / Dół	Lower / Dół
<input type="checkbox"/>	.016" x .022"	.017" x .025"	.019" x .025"
24 mm	DO.4324.62	DO.4324.75	DO.4224.95
26 mm	DO.4326.62	DO.4326.75	DO.4226.95
28 mm	DO.4328.62	DO.4328.75	DO.4228.95
30 mm	DO.4330.62	DO.4330.75	DO.4230.95
32 mm	DO.4332.62	DO.4332.75	DO.4232.95

UltiMax 4keyhole

4 keyhole looped archwires
Łuki retrakcyjne z pętlami poczwórne

Stainless Steel Retraction Archwires

- Anterior retraction
- Anterior intrusion
- Space closure
- Elastic engagement
- Custom formed to exact measurements
- 304 medical grade Stainless Steel

Stalowe łuki rozwierające 4-Loop są stosowane do:

- Skracania zębów przednich
- Zamykania przestrzeni międzyzębowych
- Cofania zębów przednich
- Produkowane z doskonałej stali medycznej 304v

Post or Loop Measurement Measure along incisal edge from distal of lateral to distal of opposite lateral

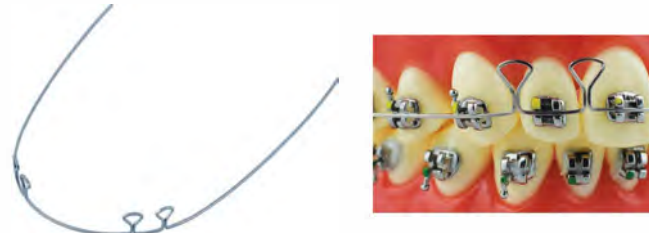

Rectangle / prostokątne	Upper / Góra	Upper / Góra	Upper / Góra
<input type="checkbox"/>	.016" x .022"	.017" x .025"	.019" x .025"
34 mm	DO.4434.62	DO.4434.75	DO.4434.95
36 mm	DO.4436.62	DO.4436.75	DO.4436.95
38 mm	DO.4438.62	DO.4438.75	DO.4438.95
40 mm	DO.4440.62	DO.4440.75	DO.4440.95
42 mm	DO.4442.62	DO.4442.75	DO.4442.95

Rectangle / prostokątne	Lower / Dół	Lower / Dół	Lower / Dół
<input type="checkbox"/>	.016" x .022"	.017" x .025"	.019" x .025"
24 mm	DO.4424.62	DO.4424.75	DO.4424.95
26 mm	DO.4426.62	DO.4426.75	DO.4426.95
28 mm	DO.4428.62	DO.4428.75	DO.4428.95
30 mm	DO.4430.62	DO.4430.75	DO.4430.95
32 mm	DO.4432.62	DO.4432.75	DO.4432.95

UltiMax T-Loop

T looped archwires
Łuki retrakcyjne z pętlami T podwójne

Stainless Steel Retraction Archwires

- Anterior retraction
- Anterior intrusion
- Space closure
- Elastic engagement
- Custom formed to exact measurements
- 304 medical grade Stainless Steel

Stalowe łuki rozwierające T-Loop są stosowane do:

- Skracania zębów przednich
- Zamykania przestrzeni międzyzębowych
- Cofania zębów przednich
- Produkowane z doskonałej stali medycznej 304v

Post or Loop Measurement Measure along incisal edge from distal of lateral to distal of opposite lateral

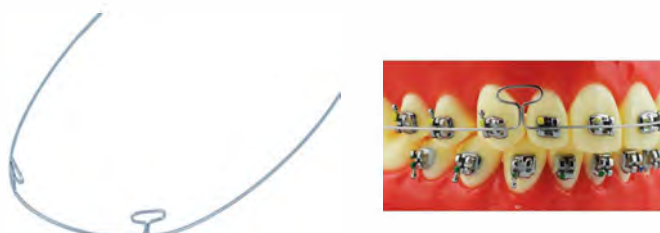

Rectangle / prostokątne	Upper / Góra	Upper / Góra	Upper / Góra
<input type="checkbox"/>	.016" x .022"	.017" x .025"	.019" x .025"
34 mm	DO.4534.62	DO.4534.75	DO.4534.95
36 mm	DO.4536.62	DO.4536.75	DO.4536.95
38 mm	DO.4538.62	DO.4538.75	DO.4538.95
40 mm	DO.4540.62	DO.4540.75	DO.4540.95
42 mm	DO.4542.62	DO.4542.75	DO.4542.95

Rectangle / prostokątne	Lower / Dół	Lower / Dół	Lower / Dół
<input type="checkbox"/>	.016" x .022"	.017" x .025"	.019" x .025"
24 mm	DO.4524.62	DO.4524.75	DO.4524.95
26 mm	DO.4526.62	DO.4526.75	DO.4526.95
28 mm	DO.4528.62	DO.4528.75	DO.4528.95
30 mm	DO.4530.62	DO.4530.75	DO.4530.95
32 mm	DO.4532.62	DO.4532.75	DO.4532.95

UltiMax 8

8 Strand twist stainless steel archwires
Łuki stalowe plecione 8-nitkowe

- Stable for finishing and holding
- 302SS Stainless Steel
- Gentle force levels with excellent torque control
- Smooth bright finish
- Does not unravel when cut
- Etched midline

- Stabilizuje uzębienie w końcowej fazie leczenia i w fazie retencji
- Ze stali typu 302SS
- Oddziałuje delikatnymi siłami przy znakomitej kontroli toroku
- Wykończony gładkim polerowaniem
- Zaznaczony środek łuku
- Nie rozplątuje się po przecięciu

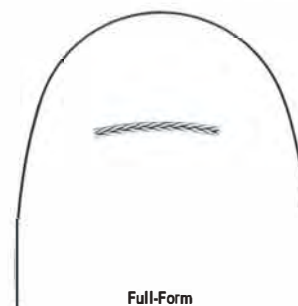

Rectangle / prostokątne	Upper / Góra	Square / kwadratowe	Upper / Góra
<input type="checkbox"/>	.016" x .022"	<input type="checkbox"/>	.016" x .016"
.017" x .025"	DO.4834.62		DO.4832.16
.018" x .025"	DO.4834.75		
.019" x .025"	DO.4834.85		
.019" x .025"	DO.4834.95		
.021" x .025"	DO.4835.15		

Rectangle / prostokątne	Lower / Dół	Square / kwadratowe	Lower / Dół
<input type="checkbox"/>	.016" x .022"	<input type="checkbox"/>	.016" x .016"
.017" x .025"	DO.4837.62		DO.4833.16
.018" x .025"	DO.4837.75		
.019" x .025"	DO.4837.85		
.019" x .025"	DO.4837.95		
.021" x .025"	DO.4837.15		



InvisaMax™

Tooth-Tone stainless steel archwires / Łuki stalowe kosmetyczne

The same great features as our InvisaMax stainless steel archwires with a durable tooth colored overcoat which offers superior aesthetics, stain resistance, and low friction.
Size shown is finished size. Tooth Tone coating adds .002" thickness to diameter

Odporne na przebarwienia łuki powlekane Tooth Tone zapewniają dużą estetykę oraz niskie tarcie. Rozmiar łuku zawiera pokrycie o grubości .002"



Pack of 2 pieces / Opak. 2 szt.



Full-Form

Round / okrągłe	Full-Form	
○	Upper / Góra	Lower / Dół
.014"	DO.4900.14	DO.4901.14
.016"	DO.4900.16	DO.4901.16
.018"	DO.4900.18	DO.4901.18
.020"	DO.4900.20	DO.4901.20

Square / kwadratowe	Full-Form	
□	Upper / Góra	Lower / Dół
.018" x .018"	DO.4902.18	DO.4903.18
.020" x .020"	DO.4902.20	DO.4903.20

Rectangle / prostokątne	Full-Form	
□	Upper / Góra	Lower / Dół
.016" x .022"	DO.4904.62	DO.4907.62
.018" x .025"	DO.4904.84	DO.4907.84
.019" x .025"	DO.4904.97	DO.4907.97
.021" x .025"	DO.4905.17	DO.4908.17

SANI-PAK

Aesthetic Micro-Coated Archwires Łuki estetyczne pokryte mikro-warstwą

The perfect combination of aesthetics and functionality
Micro coating is only done on labial surface of archwire to reduce friction and improve sliding mechanics compared to fully coated wire.

True archwire size because coating is only .0005" thick compared to .002" of competitive brands.

The coating is resistant to staining and cracking even if the archwire shape is changed.

All Micro-Coated Archwires are individually packaged & sealed in an autoclavable pack to protect your patients from cross infection.

Doskonale połączenie estetyki i funkcjonalności.
Łuki pokryte mikro-warstwą, mikro tylko od strony wargowej, redukują tarcie oraz zapewniają swobodniejsze umieszczenie łuku niż tradycyjne łuki powlekane.

"Prawdziwy" rozmiar łuku ponieważ pokrycie wynosi .0005" w porównaniu do innych łuków, których pokrycie wynosi .002"

Pokrycie jest odporne na plamy i zadrapania, nawet gdy kształt łuku ulegnie zmianie.

Wszystkie łuki pokryte mikro-warstwą są pakowane osobno, niesterylne.



InvisaMax™ Micro Coated

Tooth-Tone micro coated stainless steel archwires Łuki stalowe kosmetyczne pokryte mikro-warstwą



Made in USA

Each / Sztuka

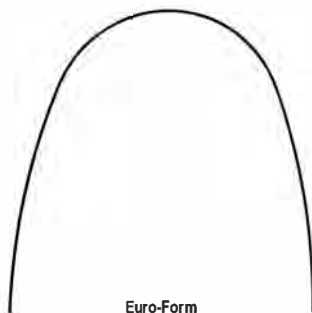

Euro-Form

Round / okrągłe	Full-Form	
○	Upper / Góra	Lower / Dół
.012"	DO.4920.12	DO.4921.12
.014"	DO.4920.14	DO.4921.14
.016"	DO.4920.16	DO.4921.16
.018"	DO.4920.18	DO.4921.18
.020"	DO.4920.20	DO.4921.20

Square / kwadratowe	Full-Form	
□	Upper / Góra	Lower / Dół
.016" x .016"	DO.4922.16	DO.4923.16

Rectangle / prostokątne	Full-Form	
□	Upper / Góra	Lower / Dół
.016" x .022"	DO.4924.62	DO.4927.62
.017" x .025"	DO.4924.75	DO.4927.75
.018" x .025"	DO.4924.85	DO.4927.85
.019" x .025"	DO.4924.95	DO.4927.95
.021" x .025"	DO.4925.15	DO.4928.15

UltiMax 3

3 Strand twist stainless steel archwires Łuki stalowe plecione 3-nitkowe



Made in USA

Pack of 10 pieces / Opak. 10 szt.



- Light force levels with good flexibility
- 302SS Stainless Steel
- Smooth bright finish

- Pliczony z trzech drucików
- Niski poziom siły z wysoką elastycznością
- Wykonany ze stali medycznej 302SS



Round / okrągłe	Full-Form	
○	Upper / Góra	Lower / Dół
.0155"	DO.4820.15	DO.4821.15
.0175"	DO.4820.17	DO.4821.17
.0195"	DO.4820.19	DO.4821.19

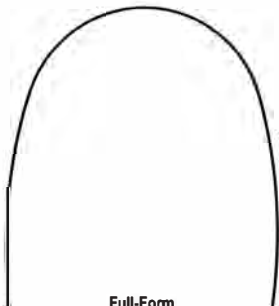

Full-Form

UltiMax 6

6 Strand twist stainless steel archwires
Łuki stalowe plecione 6-nitkowe



Made in USA

- Light force levels with good flexibility
- 302S Stainless Steel
- Smooth bright finish

- Pleciony z sześciu drucików
- Wypolerowany na połysk
- Wykonany ze stali medycznej 302SS
- Niski poziom siły z wysoką elastycznością

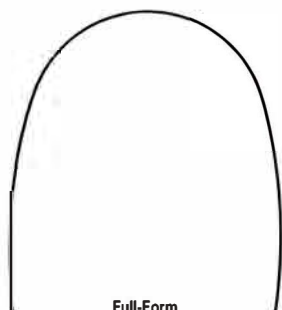

Full-Form

Pack of 10 pieces / Opak. 10 szt.



Round / okrągłe

	Upper / Góra	Lower / Dół
.0155"	DO.4830.15	DO.4831.15
.0175"	DO.4830.17	DO.4831.17
.0195"	DO.4830.19	DO.4831.19

Bio-B³

Beta titanium archwires / Łuki Beta-Tytanowe



Made in USA

Włączenie miedzi do stopu niklo-tytanowego uwydatnia termalne właściwości i charakterystykę pracy tych łuków. Mniejsza histereza łuków Copper powoduje, że w temperaturze pokojowej są one bardziej „wyczuwalne”, co przekłada się na dodatkową elastyczność, czyli łatwiejsze umieszczanie w przypadku stoczczy. Stop o unikalnej kompozycji ułatwia umiejscawianie łuków w slotach oraz sprawia, że są one odporniejsze na deformacje. Łuki Bio B 3 Copper działają z kontrolowaną siłą przez dłuższy czas, dzięki czemu rzadziej można je wymienić. Te kontrolowane poziomy siły przekładają się także na delikatne i stałe naciski, dostarczając przewidywalne w trakcie całego leczenia przemieszczenia zębów.

Dostępne w wersjach 27° C lub 35° C

- 27° C
- Większa siła działania
- 35° C
- Mniejsza siła działania

Round / okrągłe

	Upper / Góra	Lower / Dół
.016"	DO.3000.16	DO.3001.16
.018"	DO.3000.18	DO.3001.18

Square / kwadratowe

	Upper / Góra	Lower / Dół
.018" x .018"	DO.3002.18	DO.3003.18

Rectangle / prostokątne

	Upper / Góra	Lower / Dół
.016" x .022"	DO.3004.62	DO.3007.62
.017" x .025"	DO.3004.75	DO.3007.75
.018" x .025"	DO.3004.85	DO.3007.85
.019" x .025"	DO.3004.95	DO.3007.95
.021" x .025"	DO.3005.15	DO.3008.15



Nickel Free
Bezniklowe

Pack of 2 pieces / Opak. 2 szt.



UltiMax™

Stainless steel wires, straight lengths
Drut stalowy w sztańdze



Made in USA

- 302SS Stainless Steel
- Made in the USA
- Smooth bright finish

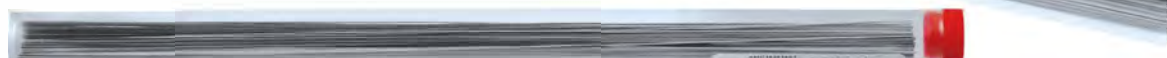

Round / okrągłe	Square / kwadratowe	Rectangle / prostokątne			
.012"	DO.4280.12	.016" x .016"	DO.4281.16	.016" x .022"	DO.4282.62
.014"	DO.4280.14	.018" x .018"	DO.4281.18	.017" x .025"	DO.4282.75
.016"	DO.4280.16			.018" x .025"	DO.4282.85
.018"	DO.4280.18			.019" x .025"	DO.4282.95
.020"	DO.4280.20			.021" x .025"	DO.4283.15

14" (356mm) long, pack of 25 pieces / 14" (356mm) długość, opak. 25 szt.

Crimpable tubes and stops Zaciskane stopery na łuki



Pack of 10 pieces
Opak. 10 szt.

Code / Kod	Size / Rozmiar
DO.5330.01	0.30 x 2.0mm, 0.022"
DO.5330.03	0.30 x 2.2mm, 0.022"



Pack of 10 pieces
Opak. 10 szt.

Code / Kod	Size / Rozmiar
DO.5331.01	0.015", 2mm
DO.5331.02	0.019", 2mm



Pack of 5 pieces
Opak. 5 szt.

Code / Kod	Size / Rozmiar
DO.5332.01	0.022"



Australian wire in spool / Druty australijskie

The wires on this page are listed in order of resilience. The Regular and Regular Plus are easily formed and are excellent wires for general use and utility wires. The Special, Special Plus and Premium wires are ideal for bite opening and where high resilience is required. The finer wires such as Premium Plus and Supreme are ideal for auxiliaries.

Drut australijski - stworzony przez firmę A. J. Wilcock Co. drut australijski doskonale nadaje się do prowadzenia leczenia ortodontycznego. Cechuje go wysoka wytrzymałość i zwiększona sprężystość.

A. J. Wilcock Cock oferuje całą gamę rozmiarów drutu australijskiego oraz jego różnych kategorii:

- Regular Pink
- Regular+ Green
- Special Blue
- Special+ Yellow
- Premium Purple
- Premium+ Gold
- Premium+ Pulse



7.6 m wire spool

W zależności od wybranego rodzaju drut australijski nadaje się do ogólnych zastosowań, jako element pomocniczy w leczeniu, do otwierania zgrzyz w przypadkach gdzie wymagana jest duża odporność drutu.

Round / okrągłe

○	Regular	Regular +	Special	Special +	Premium	Premium +	Supreme
.008"	x	x	x	x	x	x	DL320037
.009"	x	x	x	x	x	x	DL320034
.010"	x	x	x	x	x	DL320028	DL320035
.011"	x	x	x	x	x	DL320029	DL320036
.012"	DL320001	DL320006	DL320011	DL320016	DL320023	DL320030	x
.014"	DL320002	DL320007	DL320012	DL320017	DL320024	DL320031	x
.016"	DL320003	DL320008	DL320013	DL320018	DL320025	DL320032	x
.018"	DL320004	DL320009	DL320014	DL320019	DL320026	DL320033	x
.020"	DL320005	DL320010	DL320015	DL320020	DL320027	x	x
.022"	DL320038	x	x	DL320021	x	x	x
.024"	DL320039	x	x	DL320022	x	x	x



Mini Titan

Crimpable stops for archwires / Zaciskane stopery na łuk

Made of 100% pure titanium / Wykonane z czystego tytanu 100%

Pack of 20 pieces / Opak. 20 szt

Closed / Zamknięte	For round wires / Na łuki okrągłe	
	.010" - .016"	DL500033
	.016" - .020"	DL500052
For rectangular wires / Na łuki prostokątne		
	.014"x.025" - .020"x.020"	DL500034
	.016"x.025" - .021"x.025"	DL500053
Open / Otwarte	For round wires / Na łuki okrągłe	
	.010" - .025"	DL500066
	For rectangular wires / Na łuki prostokątne	
	.014"x.025" - .021"x.025"	DL500054

Crimpable stops for archwires / Zaciskane stopery na łuk

DL500032
Pack of 10 pieces
Opak. 10 szt

**Disposable archwire markers
Jednorazowe oznaczniki do łuków**



DO.5395.01 Markers without dispenser / Oznaczniki bez dozownika
(Pack of 100 / Opak. 100 szt.)

DO.5395.02 Empty Dispenser / Dozownik

**Crimpable hooks
Zaciskane haczyki na łuk**

Pack of 10 pieces
Opak. 10 szt.



DO.5325.00 Short / Krótkie
.022", 1.4mm

DO.5325.02 Medium / Średnie
.022", 2.3mm

DO.5325.01 Long / Długie
.022", 3mm

DO.5325.11 Long / Długie
.022", 3mm

DO.5325.03 Left / Lewy
DO.5325.04 Right / Prawy
.022"x.025", 5.5mm

DO.5325.07 Left / Lewy
DO.5325.08 Right / Prawy
.022"x.025", 10mm

DO.5325.09 Left / Lewy
DO.5325.10 Right / Prawy
.022"x.025", 5.5mm



Crimpable ball hooks tooth tone
Haczyk z kuleczką zaciskany kosmetyczne



Pack of 10 pieces
Opak. 10 szt.



DO.5325.05
Short / Krótkie
.022"x.028", 2.3mm



DO.5325.06
Long / Długie
.022"x.028", 4mm

MaxiFlex™

NiTi preformed open coil springs
Sprężyny otwarte Niklowo-Tytanowe



Made in USA

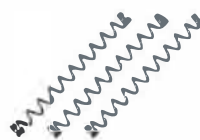

15mm long / 15mm długość

Force/Siła	Wire / Drut Ø		Inside / Przekrój Ø		Code/Kod
	Inches/Cale	mm	Inches/Cale	mm	
100gm	.009"	.23	.035"	.89	DO.5109.01
150gm	.010"	.25	.035"	.89	DO.5109.02
200gm	.011"	.28	.035"	.89	DO.5109.03

Pack of 10 pieces / Opak. 10 szt.

MaxiFlex™

NiTi open coil springs / Sprężyny otwarte Niklowo-Tytanowe

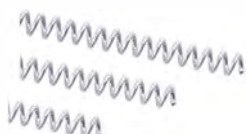
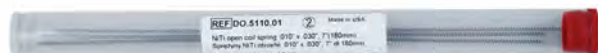

Inches/Cale	Wire / Drut Ø		Inside / Przekrój Ø		Code/Kod
	mm	Inches/Cale	mm	mm	
.010"	.25	.030"	.76	DO.5110.01	
.012"	.30	.030"	.76	DO.5110.02	
.014"	.36	.036"	.91	DO.5110.03	

7" (180mm) long, pack of 3 pieces / 7" (180mm) długość, opak. 3 szt.

MaxiFlex™

NiTi open coil springs / Sprężyny otwarte Niklowo-Tytanowe



Made in USA

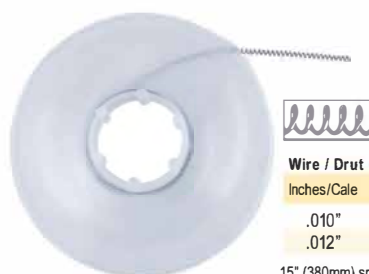

Inches/Cale	Wire / Drut Ø		Inside / Przekrój Ø		Code/Kod
	mm	Inches/Cale	mm	mm	
.010"	.25	.030"	.76	DO.5111.01	
.012"	.30	.030"	.76	DO.5111.02	

15" (380mm) spool / 15" (380mm) szpula

MaxiFlex™

NiTi distalizing springs
Sprężynki niklowo-tytanowe do dystalizacji zębów trzonowych

- Dystalizują trzonowce bez konieczności stosowania akcesoriów zewnątrzustnych
- Oddziałują siłą 140 g w przypadku 3 segmentów
- Dystalizacja rzędu 1mm do 1.5 mm w ciągu miesiąca
- Pasują do każdego rozmiaru łuku
- Czym dłuższa jest sprężynka tym mniejsza jest jej siła

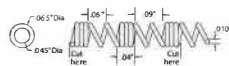

Inches/Cale	Wire / Drut Ø		Inside / Przekrój Ø		Code/Kod
	mm	Inches/Cale	mm	mm	
.010"	.25	.045"	1.14	DO.5115.01	

7" (180mm) long, pack of 3 pieces
7" (180mm) długość, opak. 3 szt.

MaxiFlex™

NiTi closed coil springs
Sprężyny zamknięte Niklowo-Tytanowe



Made in USA

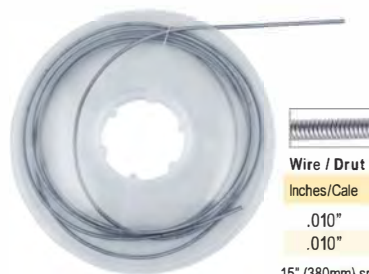

Inches/Cale	Wire / Drut Ø		Inside / Przekrój Ø		Code/Kod
	mm	Inches/Cale	mm	mm	
.010"	.25	.030"	.76	DO.5125.01	
.010"	.25	.035"	.89	DO.5125.02	

15" (380mm) spool / 15" (380mm) szpula

MaxiFlex™

NiTi closed coil springs with stainless steel eyelets
Sprężyny zamknięte Niklowo-Tytanowe z zaczepami



9 mm	Wire / Drut Ø		Inside / Przekrój Ø		Code/Kod
	Force/Siła	Inches/Cale	mm	Inches/Cale	
Light	.009"	.23	.030"	.76	DO.5150.90
Medium	.010"	.25	.030"	.76	DO.5150.91
Heavy	.011"	.28	.030"	.76	DO.5150.92

Pack of 2 pieces / Opak. 2 szt.

12 mm	Wire / Drut Ø		Inside / Przekrój Ø		Code/Kod
	Force/Siła	Inches/Cale	mm	Inches/Cale	
Light	.009"	.23	.030"	.76	DO.5151.20
Medium	.010"	.25	.030"	.76	DO.5151.21
Heavy	.011"	.28	.030"	.76	DO.5151.22

Pack of 2 pieces / Opak. 2 szt.

MaxiFlex™

Separating springs / Sprężynki separacyjne



DO.5172.01 Bicuspsids, small / Przedtrzonowce, małe
DO.5172.02 Molars, large / Trzonowce, duże
Pack of 5 pieces / Opak. 5 szt.



MaxiFlex™

NiTi separating and De-Impaction springs
Sprężynki rozklinowujące i separacyjne NiTi

.016" x .022" wide
Separating spring
Sprężynka separacyjna
szeroka



.017" x .025" long
De-Impactor
Sprężynka rozklinowująca długa

.016" x .022" narrow
Separating spring
Sprężynka separacyjna wąska

Treatment 4 weeks using .017x.025 De-Impaction spring
4 tygodniowy okres leczenia przy użyciu sprężynki rozklinowującej



Pre-Treatment / Przed leczeniem

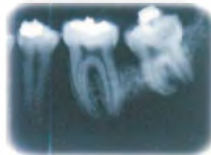

Post-Treatment / Po leczeniu

De-Impaction / Rozklinowanie
DO.5170.01
.017" x .025"
Pack of 2 pieces / Opak. 2 szt.

Separating / Separacja
DO.5171.01 Narrow / Wąska
DO.5171.02 Wide / Szeroka
.016" x .022"
Pack of 2 pieces / Opak. 2 szt.

UltiMax™

Stainless steel open coil springs / Sprężyny stalowe otwarte



Made in USA

Wire / Drut Ø		Inside / Przekrój Ø		
Inches/Cale	mm	Inches/Cale	mm	Code/Kod
.008"	.20	.022"	.56	DO.5120.00
.010"	.25	.030"	.76	DO.5120.01
.010"	.25	.036"	.91	DO.5120.02

3' (0.9m) spool / 3' (0.9m) szpula

UltiMax™

Stainless steel closed coil springs / Sprężyny stalowe zamknięte



Made in USA

Wire / Drut Ø		Inside / Przekrój Ø		
Inches/Cale	mm	Inches/Cale	mm	Code/Kod
.008"	.20	.022"	.56	DO.5130.00
.010"	.25	.030"	.76	DO.5130.01

3' (0.9m) spool / 3' (0.9m) szpula

Steiner rotation spring wedges
Sprężyna Steiner

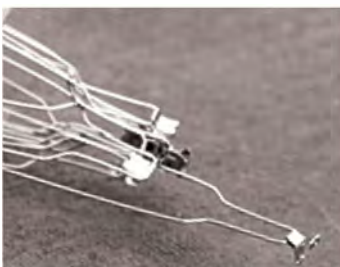

DO.5190.11
Pack of 10 pieces / Opak. 10 szt.

Rotating springs / Sprężyny do obracania zębów

Used to rotate individual teeth
Używane do obrotu pojedynczych zębów



DO.5180.01
Clockwise
Obrót zgodnie z ruchem wskazówek zegara

DO.5180.02
Anti-clockwise
Obrót przeciwny ruchowi wskazówek zegara

Pack of 2 pieces / Opak. 2 szt.

Uprighting springs
Sprężyny do prostowania pochylonych zębów

Used to upright individual teeth mesiodistally
Do prostowania zębów mezjo-dystalnie



DO.5185.01
Clockwise
Obrót zgodnie z ruchem wskazówek zegara

DO.5185.02
Anti-clockwise
Obrót przeciwny ruchowi wskazówek zegara

Pack of 2 pieces / Opak. 2 szt.

Ligature wire / Drut ligaturowy



Made in Korea

Inches / Cale	mm	Code / Kod	Spool / Szpula
.010"	.25	DO.5090.10	454g

Preformed ligature ties short / Ligatury krótkie



Made in Korea

Inches / Cale	mm	Code / Kod	Pieces / Szt.
.010"	.25	DO.5006.10	1000



Made in Brazil

Inches / Cale	mm	Code / Kod	Pieces / Szt.
.010"	.25	DO.5007.10	500



Made in USA

Inches / Cale	mm	Code / Kod	Pieces / Szt.
.010"	.25	DO.5008.10	500

Ligature ties Kobayashi short / Ligatury Kobayashi krótkie



Inches / Cale	mm	Code / Kod	Pieces / Szt.
.012"	.30	DO.5001.12	100
.014"	.36	DO.5001.14	100

Ligature ties Kobayashi coated short
Ligatury kosmetyczne Kobayashi krótkie



Tooth Tone / kolorze zębów

Inches / Cale	mm	Code / Kod	Pieces / Szt.
.012"	.30	DO.5030.12	100

Preformed coated ligature ties short
Ligatury kosmetyczne krótkie



Tooth Tone / kolorze zębów

Inches / Cale	mm	Code / Kod	Pieces / Szt.
.012"	.30	DO.5020.12	100



White / Biały

Inches / Cale	mm	Code / Kod	Pieces / Szt.
.012"	.30	DO.5021.12	100

Preformed ligature ties long / Ligatury długie



Inches / Cale	mm	Code / Kod	Pieces / Szt.
.009"	.23	DO.5005.09	1000
.010"	.25	DO.5005.10	1000
.011"	.28	DO.5005.11	1000
.012"	.30	DO.5005.12	1000

Ligature ties Kobayashi long / Ligatury Kobayashi długie



Inches / Cale	mm	Code / Kod	Pieces / Szt.
.012"	.30	DO.5000.12	100
.014"	.36	DO.5000.14	100

Preformed coated ligature ties long
Ligatury kosmetyczne długie



Tooth Tone / kolorze zębów

Inches / Cale	mm	Code / Kod	Pieces / Szt.
.012"	.30	DO.5011.12	100

Tongue tamer bondable / Kolce językowe do przyklejania

Eliminates detrimental forces discourages over-active muscle activity
bonds to upper or lower arches 80 gauge foil mesh bonding base

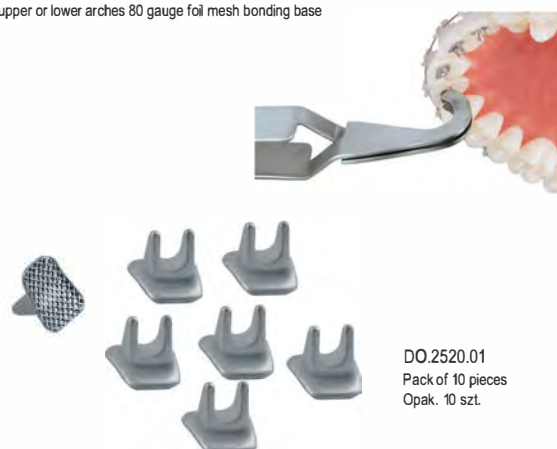

DO.2520.01
Pack of 10 pieces
Opak. 10 szt.



Tongue tamer bondable / Kolce językowe do przyklejania

Composite / kompozytowe



DO.2520.02
Pack of 10 pieces
Opak. 10 szt.

Lingual retainers bondable / Retainery językowe przyklejane



Pack of 5 pieces
Opak. 5 szt.

Mandibular / Żuchwa

Fig. 29	DO.5310.29
Fig. 31	DO.5310.31
Fig. 33	DO.5310.33
Fig. 35	DO.5310.35
Fig. 37	DO.5310.37

Maxillary / Szczeka

Fig. 38	DO.5315.38
Fig. 40	DO.5315.40
Fig. 42	DO.5315.42
Fig. 45	DO.5315.45
Fig. 47	DO.5315.47

UltiMax™

Palatal arch bars Goshgarian
Łuki Goshgarian

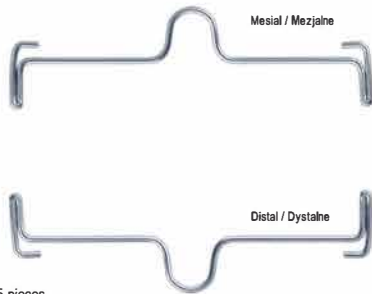

Pack of 5 pieces
Opak. 5 szt.

	Distal	Mesial
34mm	DO.5300.34	DO.5301.34
37mm	DO.5300.37	DO.5301.37
39mm	DO.5300.39	DO.5301.39
41mm	DO.5300.41	DO.5301.41
43mm	DO.5300.43	DO.5301.43
45mm	DO.5300.45	DO.5301.45
47mm	DO.5300.47	DO.5301.47
49mm	DO.5300.49	DO.5301.49
52mm	DO.5300.52	DO.5301.52
55mm	DO.5300.55	DO.5301.55

Lingual retainers bondable / Retainery językowe przyklejane

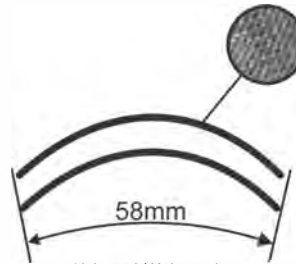

Universal / Uniwersalne

Ø 1.2 mm DO.5319.12
Ø 2.0 mm DO.5319.20



Pack of 5 pieces
Opak. 5 szt.

**Lingual retainers bondable
Retainery językowe przyklejane**

Pack of 5 pieces / Opak. 5 szt.



Maxillary lateral to lateral (2 x 2)
Szczeka - na siekacze boczne (2 x 2)

22 mm	DO.5316.22
24 mm	DO.5316.24
26 mm	DO.5316.26
28 mm	DO.5316.28
30 mm	DO.5316.30



Maxillary lateral to lateral (2 x 2)
Szczeka - na siekacze boczne (2 x 2)

14 mm	DO.5317.14
16 mm	DO.5317.16
18 mm	DO.5317.18

**Stainless steel lingual retainer wire
Drut stalowe na retainery językowe płaski**

Pack of 10 pieces
Opak. 10 szt.



DL390005

.010" x .028", 8 braid, 15cm, 6" / płaski .010" x .028" plecione 8-nitek 15cm, 6"

**Titanium lingual retainer wire
Drut tytanowe na retainery językowe płaski**

Pack of 10 pieces
Opak. 10 szt.



DL390007

Titanium .010" x .028", 15cm, 6" / Tytanowe płaski .010" x .028", 15cm, 6"

Pack of 10 pieces
Opak. 10 szt.



DL390008

Titanium .010" x .028", 3 braid, 15cm, 6" / Tytanowe płaski .010" x .028" plecione 3-nitek 15cm, 6"

Lingual retainer wire /
Drut na retainery językowe płaski

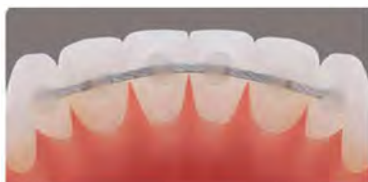

DO.5320.00

.010" x .028", 6 braid, 15cm, 6" / płaski .010" x .028" plecione 6-nitek 15cm, 6"

Grid for symmetric measurements /
Karta do pomiarów symetrycznych

Made of plexiglas, for symmetric measurements of dental arch on plaster casts, in millimetres.

Do symetrycznych pomiarów łuków zębowych na modelach gipsowych. Wykonana z plexiglasu.



DO.154.000

Wires organizers / Stojaki na łuki



DO.5390.00
197 x 95 x 94mm
Archwire organizer with cover



DO.5390.03
200 x 100 x 99mm
Archwire organizer with cover for round wires



DO.5390.05
256 x 111 x 99mm
Archwire organizer with cover for square and round wires



DO.5390.04
200 x 100 x 99mm
Archwire organizer with cover for square and rectangle wires

ElastoMAX™

Elastic ligatures
Ligatury elastyczne



Made in USA



Bite size ties



Elast - o - ties

- High elasticity and fade resistant
- Excellent rebound
- Medical grade polyurethane
- Latex-free
- Nie zawierają lateksu i są hipoalergiczne
- Trwale, odporne na blaknięcie koloru
- Bardzo elastyczne - znakomicie spełniają swoją rolę
- Poliuretan klasy medycznej
- Kształt ułatwiający aplikację
- Zapewniona stała siła na długie okresy czasu

Colors / Kolory			
	Aqua / Turkus	DO.5516.17	x
	Baby blue / Błękitne	DO.5516.21	DO.5534.21
	Kelly green / Zieleń wiosenna	DO.5516.32	x
	Lilac / Fioletowe	DO.5516.61	x
	Red / Czerwone	DO.5516.47	x
	Royal blue / Niebieskie	DO.5516.13	DO.5534.13
	Baby pink / Jasnoróżowe	DO.5516.53	DO.5534.53
	Black / Czarne	DO.5516.09	x
	Magenta / Bordowy	x	x
	Marigold / Złoty metalik	x	x
	Sparkle blue / Niebieski metalik	DO.5512.13	x
	Sparkle green / Zielony metalik	x	x
	Caroline blue / Jasnoniebieskie	DO.5516.19	x
	Clear / Przezroczyste	DO.5516.01	x
	Midnight blue / Granatowe	x	DO.5534.01
	Ivory / W kolorze zębów	DO.5516.03	x
	Sparkle red / Czerwony metalik	DO.5516.89	DO.5535.47
	Silver / Srebrny metalik	DO.5516.87	DO.5535.04
	Coral / Fluorescencyjny czerwony	DO.5513.47	x
	Emerald green	x	x
	Neon green / Fluorescencyjny zielony	DO.5513.30	x
	Neon pink / Fluorescencyjny różowy	DO.5513.53	DO.5534.51
	Teal / Zielonomodry	x	x
	Fuchsia / Fuksja	DO.5516.55	x
	Glow in the dark / świecący klasyczny	DO.5516.01	x
	Orange / Pomarańczowe	DO.5516.70	x
	Pearl / Perłowe	DO.5516.91	DO.5533.01
	Turquoise / Morskie	DO.5516.25	x
	White / Białe	DO.5516.01	x
	Gold / Złoty	DO.5516.86	x
	Grey / Szare	DO.5516.05	x
	Periwinkle / Lawendowy	DO.5516.58	x
	Purple / Purpurowy	DO.5516.59	x
	Yellow / Żółte	DO.5516.77	x

10 ligatures per stick,
pack of 1000 ligatures
10 ligatury na pasku,
opak. 1000 ligatur

24 ligatures per stick,
pack of 1008 ligatures
24 ligatury na pasku,
opak. 1008 ligatur

84 ligatures per stick,
pack of 1008 ligatures
84 ligatury na pasku,
opak. 1008 ligatur

Mini elastic ligatures
Ligatury elastyczne Mini

- *.095 Diameter
- * Stretchable Material
- * Excellent Memory
- * Great for Single or Small Brackets - Holds Tight
- * Will Stretch around Various Size Brackets
- * Will Return Near Original Size - Holding Tight Around Bracket



Made in USA

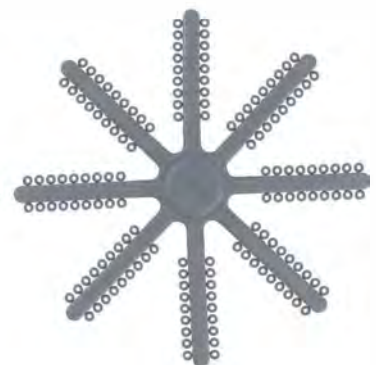
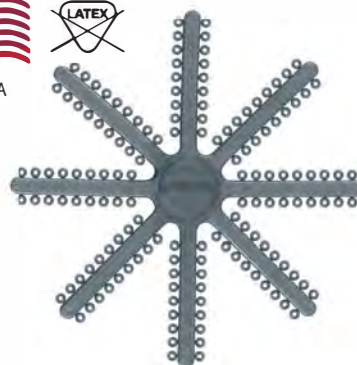

Colors / Kolory	Code / Kod
	Grey DO.5517.05
	Clear / Przezroczyste DO.5517.01
	Silver / Srebrny metalik DO.5517.04

144 ligatures per stick,
pack of 1008 ligatures
144 ligatury na pasku,
opak. 1008 ligatur



ElastoMAX™

- High elasticity and fade resistant
- Excellent rebound
- Medical grade polyurethane
- Latex-free

- Stały i odporny na blaknięcie kolor
- Idealnie dopracowana elastyczność
- Z wysokiej jakości poliuretanu
- Bez lateksu



Made in USA



ACTIVE LIGATION



PASSIVE LIGATION

- A new revolutionary tie designed to apply either passive or active ligation using traditional twin brackets.
- When placed vertically, the wire is minimally pressed against the bracket which is useful during early treatment.
- When placed horizontally, the wire is fully engaged in the bracket for maximum control.

Colors / Kolory	Code / Kod
Aqua / Jasnoniebieski	DO.5518.17
Baby blue / Błękitny	DO.5518.21
Kelly green	DO.5518.34
Lilac	x
Red / Czerwone	DO.5518.47
Royal blue	DO.5518.13
Baby pink / Jasnoróżowe	DO.5518.53
Black / Czarne	DO.5518.09
Caroline blue	x
Clear / Przezroczyste	DO.5518.01
Silver / Srebrny metalik	DO.5518.04
Neon green	DO.5518.30
Neon pink	DO.5518.51
Orange	DO.5518.70
Pearl / Perłowe	x
Turquoise	DO.5518.25
White	DO.5518.02
Grey	DO.5518.05
Purple	DO.5518.61
Yellow	DO.5518.77

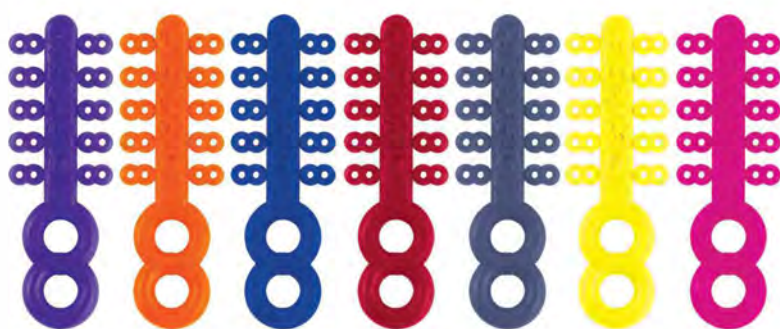

Figure 8 ties

10 ligatures per stick,
pack of 200 ligatures

10 ligatury na pasku,
opak. 200 ligatur

ElastoMAX™

Septo II Non-Radiopaque separators / Separatory Non-Radiopaque

The unique protection knobs are moulded lingually and labially to provide protection against sub-gingival loss.

Additionally the knobs allow for easier removal prior to banding.

Smooth molded design for patient comfort

Non-Radiopaque: no barium sulphate to degrade the elastomeric memory

Latex Free: safe for sensitive patients

Po stronie językowej i przedścionkowej umieszczone są unikalne guziczki ochronne, które zapobiegają utracie tkanek poddziąsłowych. Ponadto guziczki te łatwiej się usuwa przed zakładaniem pierścieni.

Gładkie wykończenie dla komfortu pacjenta

Przepuszczalne dla promieni rentgenowskich: nie zawierają siarczany baru, który pozbawia elastomery pamięci kształtu

Bez lateksu: bezpieczne dla wrażliwych pacjentów

Wyprodukowano w USA



Made in USA



DO.5818.01
Medium force
Pack of 960 pieces /
Opakowanie zawiera 960 sztuk

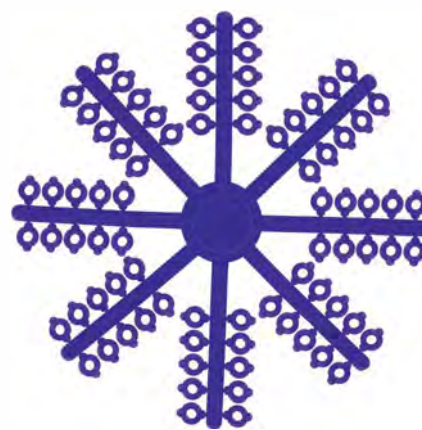

DO.5818.02
Heavy force
Pack of 960 pieces /
Opakowanie zawiera 960 sztuk



ElastoMAX™

Sepo I separators / Sepo I Separatory

.180" in diameter, these "non-latex" elastic separators have high strength and excellent memory, required for spacing teeth, ideal for posterior separator.



Made in USA

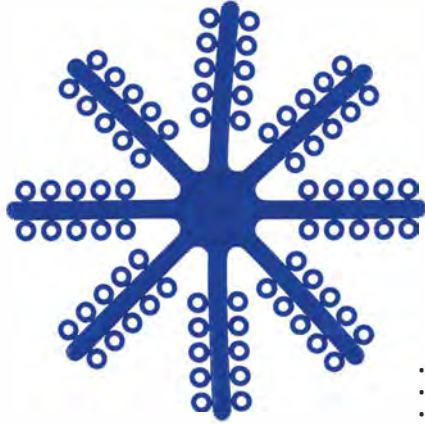

DR.58 17.02
Pack of 960 pieces /
Opakowanie zawiera 960 sztuk

- Non-Radiopaque
- Niewidoczne na zdjęciach rentgenowskich
- Bez lateksu

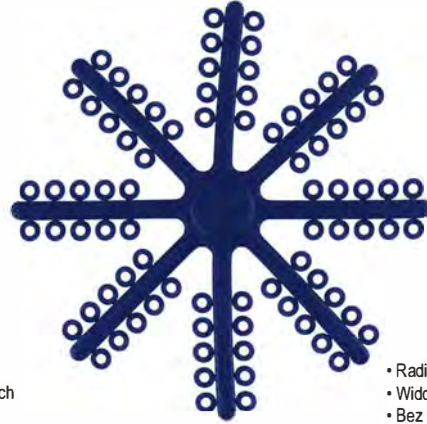

DR.5817.01
Pack of 960 pieces /
Opakowanie zawiera 960 sztuk

- Radiopaque
- Widoczne na zdjęciach rentgenowskich
- Bez lateksu

ElastoMAX™

Uno ligatures / Ligatury Uno

- High elasticity and fade resistant
- Excellent rebound
- Medical grade polyurethane
- Stały i odporny na blaknięcie kolor
- Idealnie dopracowana elastyczność
- Z wysokiej jakości poliuretanu

Colors / Kolory		Uno ligatures	Uno ligatures - I
	assorted / w różnych kolorach	DO.5500.00	DO.5503.00
	Aqua	DO.5500.17	DO.5503.17
	Baby blue	DO.5500.21	DO.5503.21
	Kelly green	DO.5500.34	DO.5503.34
	Lilac	DO.5500.60	DO.5503.60
	Red / Czerwone	DO.5500.47	DO.5503.47
	Royal blue	x	x
	Baby pink / Jasnoróżowe	DO.5500.53	DO.5503.53
	Black / Czarne	DO.5500.09	DO.5503.09
	Magenta	DO.5500.00	DO.5503.00
	Marigold / Złoty metalik	DO.5500.28	DO.5503.28
	Sparkle blue / Niebieski metalik	DO.5500.12	DO.5503.12
	Sparkle green /	x	x
	Caroline blue	x	x
	Clear / Przezroczyste	DO.5500.01	DO.5503.01
	Midnight blue	DO.5500.13	DO.5503.13
	Ivory / W kolorze zębów	DO.5500.03	DO.5503.03
	Sparkle red / Czerwony metalik	x	x
	Silver / Srebrny metalik	DO.5500.05	DO.5503.05
	Coral	x	x
	Emerald green	x	x
	Neon green	DO.5500.30	DO.5503.30
	Neon pink	DO.5500.51	DO.5503.51
	Teal	x	x
	Fuchsia / Fuksja	DO.5500.55	DO.5503.55
	Glow in the dark / świecący klasyczny	x	x
	Orange	DO.5500.70	DO.5503.70
	Pearl / Perłowe	x	x
	Turquoise	x	x
	White	DO.5500.02	DO.5503.02
	Gold	x	x
	Grey	x	x
	Periwinkle	x	x
	Purple	DO.5500.59	DO.5503.59
	Yellow	DO.5500.77	DO.5503.77

26 ligatures per stick,
pack of 1040 ligatures

26 ligatures per stick,
pack of 1040 ligatures

26 ligatury na pasku,
opak. 1040 ligatur

26 ligatury na pasku,
opak. 1040 ligatur

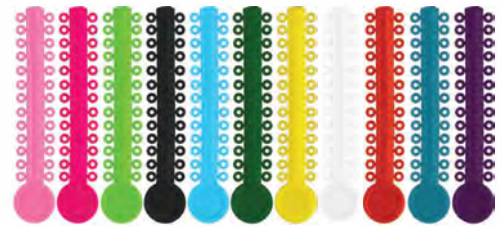

Uno ligatures

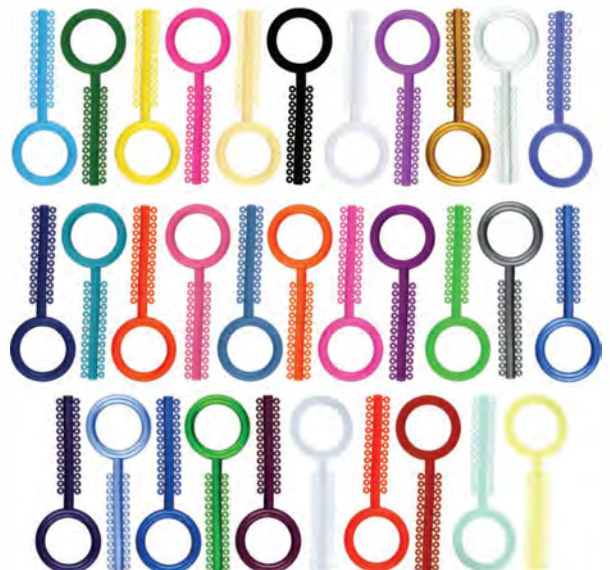
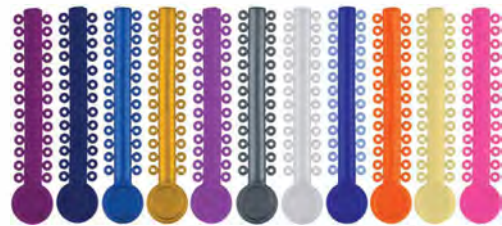

Uno ligatures - I

ElastoMAX™

Elastomeric chains / Łańcuszki elastyczne



4.5m per spool
4,5m na szpuli



Closed / Ciągłe



Short / Krótkie



Long / Długie

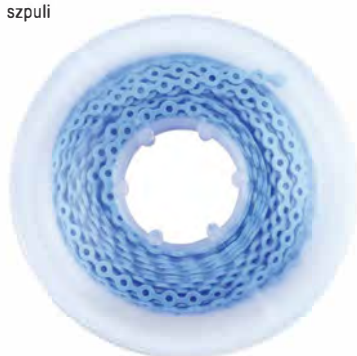

Made in USA

Latex Free / Bez lateksu



DO.5981.03



DO.5981.02

Standard

Closed
Ciągłe

Short
Krótkie

Long
Długie

Uno

Closed
Ciągłe

Short
Krótkie

Long
Długie

Colors / Kolory		Standard			Uno		
		Closed Ciągłe	Short Krótkie	Long Długie	Closed Ciągłe	Short Krótkie	Long Długie
	Aqua	x	x	DO.5741.25	x	x	x
	Baby blue	DO.5711.21	DO.5721.21	DO.5741.21	DO.5760.21	DO.5770.21	DO.5780.21
	Kelly green	x	x	x	DO.5760.34	DO.5770.34	DO.5780.34
	Lilac	x	x	x	DO.5760.60	DO.5770.60	DO.5780.60
	Red / Czerwone	DO.5711.47	DO.5721.47	DO.5741.47	DO.5760.47	DO.5770.47	DO.5780.47
	Royal blue	x	x	x	x	x	x
	Baby pink / Jasnoróżowe	DO.5711.53	DO.5721.53	DO.5741.53	DO.5760.53	DO.5770.53	DO.5780.53
	Black / Czarne	DO.5711.09	DO.5721.09	DO.5741.09	DO.5760.09	DO.5770.09	DO.5780.09
	Magenta	x	x	x	x	x	x
	Marigold / Złoty metalik	x	x	x	x	x	x
	Sparkle blue / Niebieski metalik	x	x	x	x	x	x
	Sparkle green /	x	x	x	x	x	x
	Caroline blue	x	x	x	x	x	x
	Clear / Przezroczyste	DO.5711.01	DO.5721.01	DO.5741.01	DO.5760.01	DO.5770.01	DO.5780.01
	Midnight blue	x	x	x	x	x	x
	Ivory / W kolorze zębów	DO.5711.03	DO.5721.03	DO.5741.03	x	x	x
	Sparkle red / Czerwony metalik	x	x	x	x	x	x
	Silver / Srebrny metalik	DO.5711.05	DO.5721.05	DO.5741.05	DO.5760.05	DO.5770.05	DO.5780.05
	Coral	x	x	x	x	x	x
	Emerald green	x	x	x	x	x	x
	Neon green	DO.5711.32	DO.5721.32	DO.5741.32	DO.5760.30	DO.5770.30	DO.5780.30
	Neon pink	DO.5711.51	DO.5721.51	DO.5741.51	DO.5760.55	DO.5770.55	DO.5780.55
	Teal	x	x	x	x	x	x
	Fuchsia / Fuksja	x	x	x	DO.5760.51	DO.5770.51	DO.5780.51
	Glow in the dark / świecący klasyczny	DO.5715.01	DO.5725.01	DO.5745.01	x	x	x
	Orange	DO.5711.70	DO.5721.70	DO.5741.70	x	x	x
	Pearl / Perłowe	DO.5710.01	DO.5720.01	DO.5740.01	x	x	x
	Turquoise	DO.5711.25	DO.5721.25	DO.5741.25	x	x	x
	White	DO.5711.02	DO.5721.02	DO.5741.02	x	x	x
	Gold	x	x	x	x	x	x
	Grey	x	x	x	x	x	x
	Perlwinkle	x	x	DO.5741.58	x	x	x
	Purple	DO.5711.59	DO.5721.59	DO.5741.59	DO.5760.61	DO.5770.61	DO.5780.61
	Yellow	DO.5711.77	DO.5721.77	DO.5741.77	DO.5760.77	DO.5770.77	DO.5780.77



ElastoMAX™

Latex free elastomeric products
Produkty elastyczne bez lateksu

Elastic thread solid round
Nić elastyczna, okrągła pełna



Made in USA



Clear / Przezroczysta
.025" DO.5880.01
.030" DO.5881.01
Grey / Szara
.025" DO.5880.02
.030" DO.5881.02

7,5 m per spool / 7,5m na szpuli



Elastic thread hollow round
Nić elastyczna, okrągła pusta



Made in USA



Clear / Przezroczysta
.025" DO.5887.01
.030" DO.5888.01
Grey / Szara
.025" DO.5887.02
.030" DO.5888.02

7,5 m per spool / 7,5m na szpuli



Archwire sleeves
Ostonki na łuki



Made in USA



Clear / Przezroczysta
.018" DO.5892.01
.027" DO.5893.01
Grey / Szara
.018" DO.5892.02
.027" DO.5893.02

3 m per spool / 3m na szpuli



Lip bumper sleeves
Ostonki na pelotę wargową



Made in USA



Clear / Przezroczysta
.046" DO.5894.01

Grey / Szara
.046" DO.5894.02

3 m per spool / 3m na szpuli



Rotation wedges
Kliny rotacyjne



A: Standard wedge / Klin standardowy

Clear / Przezroczysty DO.5850.01
Grey / Szary DO.5850.02

10 wedges per stick, Pack of 100 pieces
10 klinów na pasku, Opakowanie zawiera 100 sztuk



Rotation wedges
Kliny rotacyjne



Pack of 100 pieces
Opakowanie zawiera 100 sztuk

Clear / Przezroczysty DO.5853.01
Grey / Szary DO.5853.02

Elastomeric ligatures and chains organizers
Stojaki na ligatury elastyczne i łańcuszki



DO.5980.01



DO.5982.01



DO.5980.02

Radiopaque posterior separators
Separatory Radiopaque, posterior



DO.5816.01
Pack of 1000 pieces / Opakowanie zawiera 1000 sztuk

Elastomeric ligature placement gun
Pistolet do zakładania ligatur elastycznych



DO.5980.00

Creatures of the Sky

Latex free Uno-intraoral elastics
Gumki / Uno-Wyciągi elastyczne bez lateksu



Box of 20 packs (100 elastics per pack) 2000 pieces
Paczka 20 torebek (100 wyciągów w torebce) 2000 sztuk

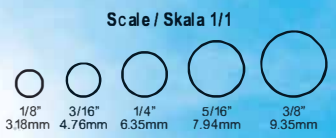

Force level / Siła wyciągu

Light Force / Siła wyciągu lekka	2.5 oz. = 71gm
Medium Force / Siła wyciągu średnia	3.5 oz. = 100gm
Heavy Force / Siła wyciągu duża	4.5 oz. = 130gm
X-Heavy Force / Siła wyciągu bardzo duża	6.5 oz. = 180gm

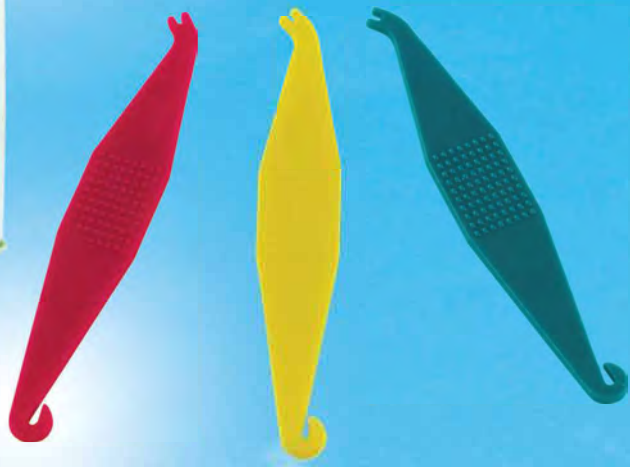

Free / Gratis
20 x Elastic directors
20 x Nakładaczy do wyciągów elastycznych



Latex free clear elastics / Przezroczyste wyciągi elastyczne				
	2.5oz Light / 2.5oz Lekka	3.5oz. Medium / 3.5oz Średnia	4.5oz. Heavy / 4.5oz Duża	6.5oz. X-Heavy / 6.5oz Bardzo duża
1/8" (3.2mm)	DO.5960.32	DO.5961.32	DO.5962.32	DO.5963.32
3/16" (4.8mm)	DO.5960.48	DO.5961.48	DO.5962.48	DO.5963.48
1/4" (6.4mm)	DO.5960.64	DO.5961.64	DO.5962.64	DO.5963.64
5/16" (7.9mm)	DO.5960.79	DO.5961.79	DO.5962.79	DO.5963.79
3/8" (9.5mm)	DO.5960.95	DO.5961.95	DO.5962.95	DO.5963.95

Creatures of the Sky

Latex free intraoral elastics
Gumki / Wyciągi elastyczne bez lateksu
Made in USA



Box of 20 packs (100 elastics per pack) 2000 pieces
Paczka 20 torebek (100 wyciągów w torebce) 2000 sztuk

Scale / Skala 1/1

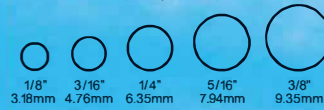

Force level / Siła wyciągu

Light Force / Siła wyciągu lekka	2.5 oz = 71gm
Medium Force / Siła wyciągu średnia	4.5 oz = 125gm
Heavy Force / Siła wyciągu duża	6.5 oz = 180gm



Free / Gratis

20 x Elastic directors
20 x Nakładaczy do wyciągów elastycznych

Light force level / Siła wyciągu lekka 2.5 oz. (71 gm)



Hummingbird / koliber
1/8" (3.18 mm)



Canary / kanarek
3/16" (4.76 mm)



Finch / zięba
1/4" (6.35 mm)



Starling / szpak
5/16" (7.94 mm)



Cuckoo / kukułka
3/8" (9.35 mm)

Medium force level / Siła wyciągu średnia 4.5 oz. (125 gm)



Love birds / papużki nierozłączki
1/8" (3.18 mm)



Parakeet / papużka
3/16" (4.76 mm)



Parrot / papuga
1/4" (6.35 mm)



Cockatoos / kakadu
5/16" (7.94 mm)



Macaw / ara
3/8" (9.35 mm)

Heavy force level / Siła wyciągu duża 6.5 oz. (180 gm)



Harrier / błotniak
1/8" (3.18 mm)



Kestrel / pustulka
3/16" (4.76 mm)



Falcon / sokół
1/4" (6.35 mm)



Hawk / jastrząb
5/16" (7.94 mm)



Eagle / orzeł
3/8" (9.35 mm)

Creatures of the Sky

Latex free intraoral elastics
Gumki / Wyciągi elastyczne bez lateksu
Made in USA



Latex free clear elastics / Przezroczyste wyciągi elastyczne			
	2.5oz Light / 2.5oz Lekka	4.5oz. Medium / 4.5oz Średnia	6.5oz. Heavy / 6.5oz Duża
1/8" (3.2mm)	DO.5950.32	DO.5952.32	DO.5953.32
3/16" (4.8mm)	DO.5950.48	DO.5952.48	DO.5953.48
1/4" (6.4mm)	DO.5950.64	DO.5952.64	DO.5953.64
5/16" (7.9mm)	DO.5950.79	DO.5952.79	DO.5953.79
3/8" (9.5mm)	DO.5950.95	DO.5952.95	DO.5953.95



Latex free neon colors / Kolorowe wyciągi elastyczne			
	2.5oz Light / 2.5oz Lekka	4.5oz. Medium / 4.5oz Średnia	6.5oz. Heavy / 6.5oz Duża
1/8" (3.2mm)	DO.5956.32	DO.5958.32	DO.5959.32
3/16" (4.8mm)	DO.5956.48	DO.5958.48	DO.5959.48
1/4" (6.4mm)	DO.5956.64	DO.5958.64	DO.5959.64
5/16" (7.9mm)	DO.5956.79	DO.5958.79	DO.5959.79
3/8" (9.5mm)	DO.5956.95	DO.5958.95	DO.5959.95

Elastic directors / Nakładacze do wyciągów elastycznych

Elastic directors make placing and removing elastics easy for patients

Pack of 50 pieces / Opak. 50 szt.

Nakładacze do wyciągów elastycznych ułatwiają pacjentowi ich nakładanie i usuwanie.

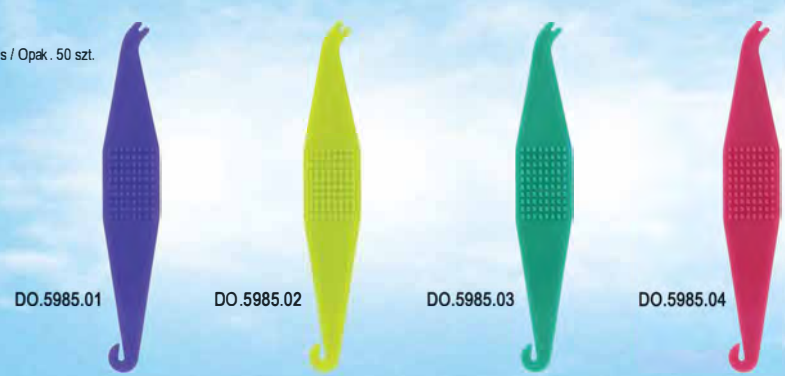



alpha-dent®
One-Step Adhesive syringe
Klej One-Step w strzykawce



DT.301-0104-001

3.5 g syringe / strzykawka 3,5g

Individual products: No-Mix or Light Cure adhesive syringe, Sealant resin, Enamel catalyst primer can be supplied on special order only.
Pojedyncze produkty tj.: klej w strzykawce światłoutwardzalny lub chemoutwardzalny i aktywatory są dostępne na specjalne zamówienie.

alpha-dent®
Enamel catalyst primer
Aktywator



DT.209-0101-001

Enamel catalyst primer 12ml / Aktywator 12ml

alpha-dent®

LIGHT CURE ORTHODONTIC ADHESIVE
ORTODONTYCZNY KLEJ DO ZAMKÓW
ŚWIATŁOUTWARDZALNY

Alpha-Dent® Light Cure Bracket Adhesive is a Paste Adhesive system formulated to bond to metal, ceramic and plastic brackets. The unique filler combination used in the paste produces an ideal bond and a smooth tacky consistency minimizing bracket flotation. By using light cure adhesive technology we have eliminated working time constraints.

Klej światłoutwardzalny jest odpowiedni do zamków metalowych, ceramicznych i plastikowych. Wyjątkowy materiał klejący gwarantuje lepkość, dzięki której zamki nie przesuwają się. Korzystanie z technologii utwardzenia kleju światłem oszczędza czas pracy lekarza.



DT.303-0002-001

Contents / Zestaw zawiera:

- 1 x 3.5gm Syringes
- 1 x Strzykawki po 3,5g
- 1 x 3ml Sealant Resin
- 1 x 3ml Aktywator
- 1 x 7ml Green Gel Etchant
- 1 x 7ml Wytrawiacz
- 50 x Mixing Pads
- 50 x Bloczków
- 2 x Mixing spatulae
- 2 x Łopatkki do mieszania
- 25 x Brushes
- 25 x Pędzelków krótkich



Made in USA

DT.303-0003-001

Contents / Zestaw zawiera:

- 4 x 3.5gm Syringes
- 4 x Strzykawki po 3,5g
- 2 x 3ml Sealant Resin
- 2 x 3ml Aktywator
- 1 x 7ml Green Gel Etchant
- 1 x 7ml Wytrawiacz
- 50 x Mixing Pads
- 50 x Bloczków
- 2 x Mixing spatulae
- 2 x Łopatkki do mieszania
- 50 x Brushes
- 50 x Pędzelków krótkich



alpha-dent[®]

**ONE STEP BRACKET ADHESIVE
ONE STEP ORTODONTYCZNY KLEJ DO
ZAMKÓW CHEMOUTWARDZALNY**



**DENTAL
TECHNOLOGIES**
Improving smiles around the world

Alpha-Dent® One-Step Bracket Adhesive is a Paste-Primer system formulated to bond to metal, ceramic and plastic brackets. The unique filler and primer combination used produces an ideal bond and a smooth tacky viscosity minimizing bracket flotation.

Klej chemoutwardzalny One-Step jest odpowiedni do zamków metalowych, ceramicznych i plastikowych. Wyjątkowe połączenie materiału klejącego i aktywatora gwarantuje lepkość, dzięki której zamki nie przesuwiają się.



DT.301-0003-001

Contents / Zestaw zawiera:

- 4 x 3.5gm Syringes
- 4 x Strzykawkę po 3,5g
- 1 x 12ml Enamel Catalyst Primer
- 1 x 12ml Aktywator
- 1 x 7g Green Gel Etchant
- 1 x 7g Wytrawiacz
- 50 x Mixing Pads
- 50 x Bloczków
- 2 x Brush Holder
- 1 x Uchwyt do pędzelków
- 50 x Brushes
- 50 x Pędzelków krótkich



alpha-dent[®]

**ONE STEP BRACKET ADHESIVE
ONE STEP ORTODONTYCZNY KLEJ DO
ZAMKÓW CHEMOUTWARDZALNY**

Starter kit / Zestaw startowy

DT.301-0008-001

Contents / Zestaw zawiera:

- 1 x 3.5gm Syringe
- 1 x Strzykawkę po 3.5g
- 1 x 5ml Enamel Catalyst Primer
- 1 x 5ml Aktywator
- 1 x 3g Green Gel Etchant
- 1 x 3g Wytrawiacz
- 50 x Mixing Pads
- 50 x Bloczków
- 2 x Mixing spatulae
- 2 x Łopatkę do mieszania
- 25 x Brushes
- 25 x Pędzelków krótkich





alpha-dent®

Light Cure adhesive syringe
Klej światłoutwardzalny w strzykawce



Made in USA

alpha-dent®

Sealant resin
Aktywator



DT.303-0202-001

3.5 g syringe / 3,5 g strzykawka

Individual products: No-Mix or Light Cure adhesive syringe, Sealant resin, Enamel catalyst primer can be supplied on special order only.
Pojedyncze produkty tj.: klej w strzykawce światłoutwardzalny lub chemoutwardzalny i aktywatory są dostępne na specjalne zamówienie.

DT.208-0101-001

Sealant resin 7ml / Aktywator 7ml

alpha-dent®

Light Cure blue band cement syringes
Cement do pierścieni światłoutwardzalny Blue

Alpha-Dent® Light Cure Band Adhesive is a single paste resin-based, fluoride containing band adhesive. The single paste adhesive requires no mixing; resulting in reducing adhesive waste, consistent adhesive performance and now working time constraints. Alpha-Dent® Light Cure Band Adhesives distinctive blue color allows you to easily see the adhesive during banding, making clean up easy. When used with a high performance curing light, cure time is 20 seconds.

Cement do pierścieni jest pastą na bazie żywicy, zawierającą fluor. Nie wymaga mieszania, oszczędza czas, redukuje marnowanie materiału. Niebieski kolor wskazuje na ewentualny nadmiar kleju przed utwardzeniem oraz ułatwia zlokalizowanie resztek kleju po usunięciu pierścienia. Należy naświetlać lampą 20 sekund.



DT.320-0000-001

Contents /Zestaw zawiera:
6 x 5gm Syringes
6 x Strzykawkę po 5 g

alpha-dent®

Light Cure blue band cement syringes
Cement do pierścieni światłoutwardzalny
Blue w strzykawce



DT-320-0101-001

5 gm Syringes / 5 g Strzykawka

Adhesive removers carbide burs
Wiertło z węgla spiekane

Each / Sztuka

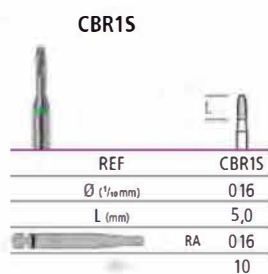

30.000 min⁻¹

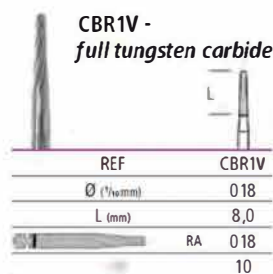

30.000 min⁻¹

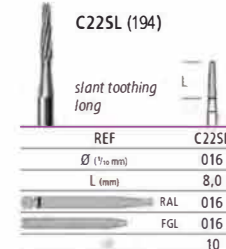
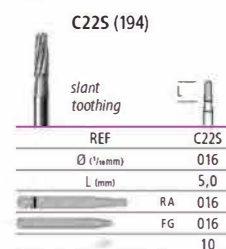
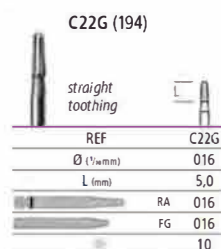

Adhesive removers latex free
Gumki polerskie do usuwania kleju / cementu bez latexu

Latex free polymer polishers with blend of soft glass granules for the removal of orthodontic cements without scratching or scraping the enamel

max. 20'000 rpm



Code / Kod	S191	S192	S193
L mm	6,5	10,5	8,0
Ø mm	3,0	5,0	6,0

Adhesive remover sets
Zestawy gumek do usuwania kleju/cementu

max. 20'000 rpm



SET1017
Adhesive remover set I - 9 pieces
Zestaw I - 9 sztuk.



Contents / Zawiera	3 pcs / szt.	3 pcs / szt.	3 pcs / szt.
L mm	6,5	10,5	8,0
Ø mm	3,0	5,0	6,0



max. 20'000 rpm



Contents / Zawiera	3 pcs / szt.	3 pcs / szt.	3 pcs / szt.	3 pcs / szt.
L mm	6,5	10,5	8,0	4,3
Ø mm	3,0	5,0	6,0	1,6



SET1018
Adhesive remover set II - 12 pieces
Zestaw II - 12 sztuk.

Prophylaxis pastes fluoride free 250g
Pasty polerskie bez fluoru 250g



Jar / Słoiczek
250 g

PP010/0051 Medium Mint / Standardowa miętowa
PP010/0052 Coarse Orange / Ostra pomarańczowa

Propyl paste cup
Pojemnik do pasty polerskiej



DZ.990.010

Prophylaxis pastes fluoride free, mint flavoured
Pasty polerskie bez fluoru, miętowe



Jar / Słoiczek
50 g.

PAS001 Medium / Średnioziarnista

Made of 100% natural ingredients.
Zawierają 100% naturalnych składników.

alpha-dent®

Orthodontic Paste
Pasta polerska bez fluoru



DENTAL TECHNOLOGIES
Improving smiles around the world

Alpha-Pro® Orthodontic Paste is a splatter-free formula that rinses easily and completely. Alpha-Pro® Orthodontic Paste comes without added color pigments, flavor and fluoride for patients who may be allergic to additives. The paste is available in medium grit and is recommended for normal cleaning, polishing, and plaque removal. The medium grit paste is ideal for use prior to composite bonding, sealants, and orthodontic bracket applications



Made in USA



DT.560-1301-002
Pack of 200 single dose / Opak 200 szt.
2 gm dispensers / 2 gm kapsułki

Bond brushes micro
Pędzelki do bondingu mikro

Made in Germany

Pack of 100 pieces
Opak, 100 szt.



DZ.8610.01



DZ.86.10.02



DZ.86.10.03



DZ.86.10.04

Bond brushes standerd
Pędzelki do bondingu standardowe

Pack of 100 pieces
Opak, 100 szt.



DZ.86.11.01



DZ.8611.02

Etching gel / Wytrawiacze

36% phosphoric acid etching gel
Wytrawiacz kwaso-fosforowy 36%



DR.2000.01 2ml
DR.2000.02 10ml
DR.2000.03 50ml

Syringes and applicator organizer
Stojak na strzykawki i mikro aplikatory



DR.9999.00

Prophy brushes RA / Szczoteczki do polerowania na kątnicę

For cleaning and polishing of natural teeth, gold, amalgam fillings and removing plaque stains. Use with prophylaxis paste.

Czyszczą i polerują zęby, złoto, wypełnienia amalgamatowe oraz redukują płytkę nazębną. Szczoteczki do profilaktyki z zastosowaniem pasty polerskiej.

max. 10'000 rpm



Code / Kod P001 P002 P003 P004 P005

White nylon / Nylonowe białe

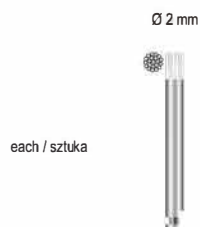

Code / Kod P006
White nylon / Nylonowe białe



White nylon / Nylonowe białe
Ø 5 mm



Code / Kod DH.5015.01 DH.5015.02

Pack / Opak 50 pieces / szt. 100 pieces / szt.

SMART Color coded prophy cups latex free RA Gumki do polerowania bez lateksu na kątnicę

max. 10'000 rpm

Use with prophylaxis paste / Używać z pastą polerską

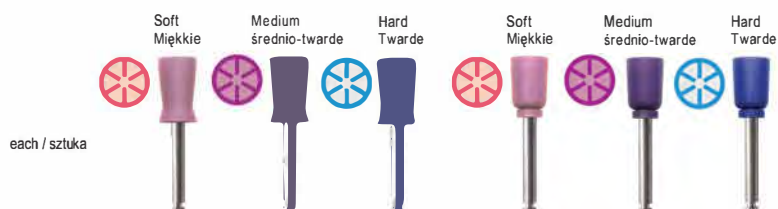

Code / Kod PSRA001 PSRA002 PSRA003 PRA001 PRA002 PRA003

Pack of 100 pieces
Opak. 100 szt.

1.500 - 3.000
r.p.m



Code / Kod DH.5009.01 DH.5009.00

Disposable prophy cups and brushes Jednorazowe gumki i szczoteczki

Pack of 100 pieces / Opak. 100 szt.

1.500 - 3.000
r.p.m



DH.5010.02 Soft / Miękkie
DH.5010.01 Regular / Standardowe
DH.5010.04 Pointed brush
Szczoteczka stożkowa
DH.5010.03 Standard brush
Szczoteczka standardowa

Bonding tray with sliding cover Etui do zamków



DO.1991.10
DO.1991.20
DO.1991.30

Disposable bonding trays Podstawki do zamków



with mixing wells
z miejscem do mieszania
DO.1990.11
DO.1990.21
without mixing wells
bez miejsca do mieszania
DO.1990.10
DO.1990.20

Disposable bonding trays organizer Stojak na podstawki do zamków



DO.1990.00

Safety release modules with stainless steel clamps / Moduły bezpieczeństwa ze stalową klamrą

Pair / Para



Force / Siła

Dark Blue
Granatowy

Light Blue
Jasnoniebieski

Green
Zielony

Purple
Purpurowy

Red
Czerwony

600 gm	DO.6121.01	DO.6121.02	DO.6121.04	DO.6121.05	DO.6121.06
750 gm	DO.6122.01	DO.6122.02	DO.6122.04	DO.6122.05	DO.6122.06

High pull head caps / Wyciągi czaszkowe



Each / Sztuka

- DO.6140.01 Small / Male
- DO.6140.02 Medium / Średnie
- DO.6140.03 Large / Duże

Cervical neck pads / Wyciągi karkowe



DO.6130.00
Assorted colors / Różne kolory
Pack of 5 pieces / Opak. 5 szt.

DO.6130.01
Blue / Niebieskie
Pack of 5 pieces / Opak. 5 szt.

DO.6130.02
Green / Zielone
Pack of 5 pieces / Opak. 5 szt.

DO.6130.03
Red / Czerwone
Pack of 5 pieces / Opak. 5 szt.

Headgear bags / Etui na wyciągi czaszkowe



DO.6145.00
Assorted colors / Różne kolory
Pack of 5 pieces / Opak. 5 szt.

Each / Sztuka

- DO.6145.01 Blue / Male
- DO.6145.02 Red / Średnie
- DO.6145.03 Yellow / Żółty
- DO.6145.04 Grey / Szary
- DO.6145.05 White / Biały

224 x 120 mm

Cervical neck pads / Wyciągi karkowe

With safety modules
Z modułów bezpieczeństwa



DO.6131.01

DO.6131.00

Extraoral elastics / Wyciągi zewnętrzne



Pack of 1000 pieces
Opak. 1000 szt.

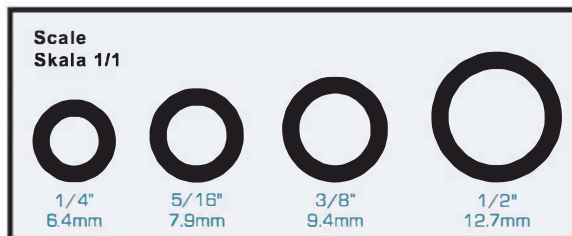

Extraoral elastics

Force / Siła	8.0 oz	14.0 oz	16.0 oz
1/4" (6.4mm)	DO.6170.01	DO.6171.01	DO.6172.01
5/16" (7.9mm)	DO.6170.02	DO.6171.02	DO.6172.02
3/8" (9.4mm)	DO.6170.03	DO.6171.03	DO.6172.03
1/2" (12.7mm)	DO.6170.04	DO.6171.04	DO.6172.04



Facebows with loops / Łuki twarzowe z pętlą

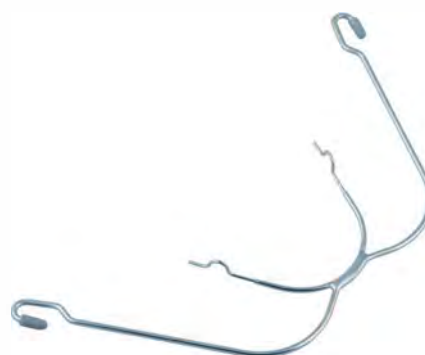

Outer bow is available in 3 lengths
Zewnętrzny łuk dostępny w 3 długościach

#	Intermolar parameter Rozpiętość	Short Krotki	Medium Sredni	Long Dlugi
1	83 mm	DO.6107.01	DO.6108.01	DO.6109.01
2	90 mm	DO.6107.02	DO.6108.02	DO.6109.02
3	97 mm	DO.6107.03	DO.6108.03	DO.6109.03
4	104 mm	DO.6107.04	DO.6108.04	DO.6109.04
5	111 mm	DO.6107.05	DO.6108.05	DO.6109.05

Intermolar parameter from loop to loop in millimeter
Rozpiętość od pętli do pętli w mm

Universal colored facebows / Łuki twarzowe uniwersalne kolorowe
Standard - Form

Outer bow / Łuk zewnętrzny Ø .072"
Inner bow / Łuk wewnętrzny Ø .045"

- DO.6105.01 White / Biały
- DO.6105.02 Blue / Niebieski
- DO.6105.03 Purple / Purpurowy
- DO.6105.04 Yellow / Żółty
- DO.6105.05 Black / Czarny
- DO.6105.06 Orange / Pomarańczowy
- DO.6105.07 Dark Green / Ciemna zieleń
- DO.6105.08 Lime Green / Jasna zieleń

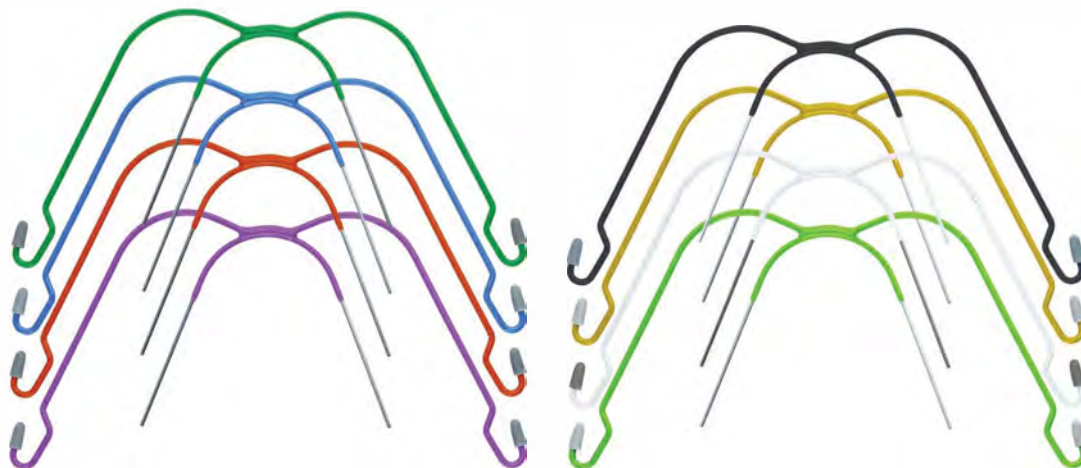

Universal facebows / Łuki twarzowe uniwersalne

Outer bow / Łuk zewnętrzny Ø .072"
Inner bow / Łuk wewnętrzny Ø .045"



Full-Form DO.6103.01
Standard-Form DO.6104.01

Plain facebows / Łuki twarzowe

Outer bow Ø .072"
Łuk zewnętrzny Ø .072"



Inner bow Ø / Łuk wewnętrzny Ø
.045" DO.6102.01

Cervical Neckpads / IOS Comfort opaski karkowe



DO.6132.01



DO.6132.04



DO.6132.02



DO.6132.05



DO.6132.03

Each / Sztuka



Made in USA

Lip Bumpers / Peloty wargowe

Wire Ø .045" / Drut Ø .045"



Color Kolor	Standard-Form		Full-Form	
	Without hooks Bez haczyków	With hooks Z haczykami	Without hooks Bez haczyków	With hooks Z haczykami
Blue / Niebieskie	DO.6115.01	DO.6116.01	DO.6117.01	DO.6118.01
Pink / Różowe	DO.6115.02	DO.6116.02	DO.6117.02	DO.6118.02
Red / Czerwone	DO.6115.03	DO.6116.03	DO.6117.03	DO.6118.03
White / Białe	DO.6115.04	DO.6116.04	DO.6117.04	DO.6118.04
Yellow / Żółte	DO.6115.05	DO.6116.05	DO.6117.05	DO.6118.05

High Pull Head Caps / Czepiec do procy bródkowej

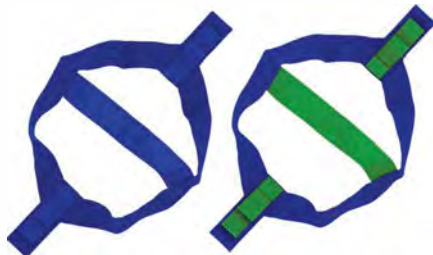

Color
Kolor

- DO.6140.04 Red / Czerwone
- DO.6140.06 Blue / Niebieski
- DO.6140.05 Green / Zielony

Chin cups / Proce bródkowe

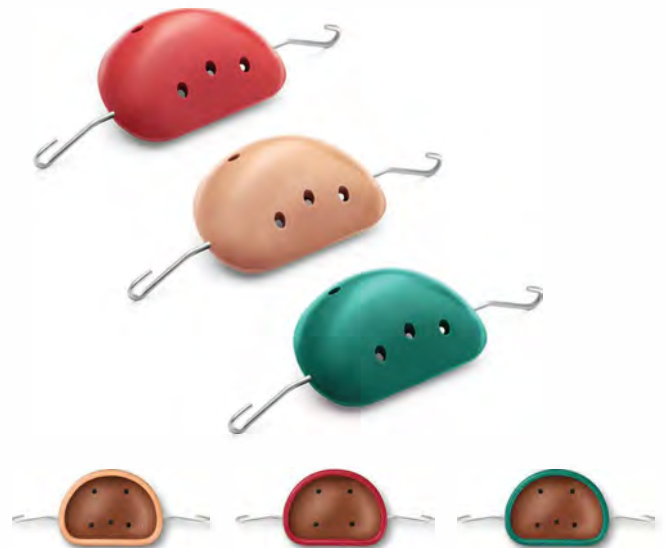

Color Kolor	For child Dla dzieci	For adult Dla dorosłych
● Red / Czerwone	DO.6141.01	DO.6142.01
● Green / Zielony	DO.6141.02	DO.6142.02
● Skin / Cielista	DO.6141.03	DO.6142.03



Face masks / Maski twarzowe

COMFI-MAX

Reverse pull face masks Delaire / Maski twarzowe Delaire



PRODOTTO
100% ITALIANO

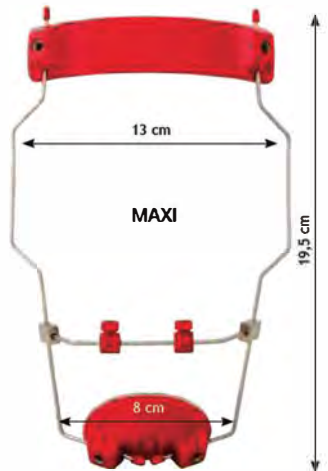
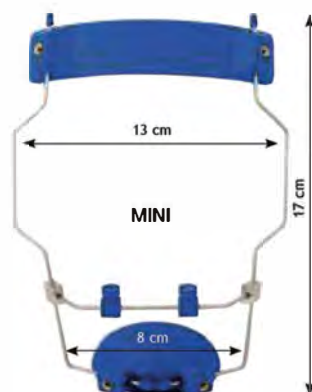

Blue
Niebieska

Green
Zielona

Red
Czerwona

White
Biala

Yellow
Zolta

Mini	DO.6150.01	DO.6150.02	DO.6150.03	DO.6150.04	DO.6150.05
Maxi	DO.6151.01	DO.6151.02	DO.6151.03	DO.6151.04	DO.6151.05

Face masks / Maski twarzowe

COMFI-MAX

Fully-Adjustable face masks
Regulowane maski twarzowe



Blue
Niebieska

Clear
Przezroczysta

Pearl
Perłowa

Red
Czerwona

Teal
Jasnozielona



DO.6154.01

DO.6154.02

DO.6154.03

DO.6154.04

DO.6154.05



violet
Fioletowa

Spider red
Czerwona pajęczyna

Heart
Serca

Graffiti
Graffiti

Camouflage
Moro

Zebra
Zebra

DO.6154.11

DO.6154.06

DO.6154.07

DO.6154.08

DO.6154.09

DO.6154.10

Face mask bags / Etui na maski twarzowe



DO.6159.00 For face masks Delaire / Na maski twarzowe Delaire

DO.6159.01 For fullyadjustable face masks / Na maski twarzowe regulowane

Assorted colors / Różne kolory
Pack of 5 pieces / Opak. 5 szt.

Bruxism splint / Szyna nagryzowa z zaczepami



- DO.6580.01 Clear Przezroczysta
- DO.6580.02 Pink / Bubble gum Różowa / Guma do żucia

Prevents the constant grinding that leads to TMJ disorder. Can be used over braces without effecting tooth movement.

Szyna jest skutecznym sposobem leczenia objawów zaburzeń stawów skroniowo-żuchwowych (TMJ) tj. zaciskania, ścierania czy zgrzytania zębami. Odpowiednia dla pacjentów noszący aparat stały

**Soft plastic comfort covers
Ochraniacze wargowe plastikowe**



DO.6241.00
Pair / Para

**Retainer case for Invisible retainers
Pudełka na retainery Invisalign**

Each / Sztuk

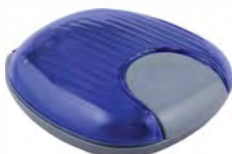

DO.6323.01



DO.6323.02



**Silicone comfort covers
Ochraniacze wargowe silikonowe**



DO.6240.00
Pair / Para

**Retainer retrievers
Instrument do zdejmowania elastycznych aparatów retencyjnych**



Each / Sztuk

- DO.6500.01 Blue / Niebieski
- DO.6500.02 Green / Zielony
- DO.6500.03 Pink / Różowy
- DO.6500.04 Orange / Pomarańczowy
- DO.6500.05 White / Biały

**Elasti-Bite
Therapy wafers scented / Wafel do nagryzania zapachowy**



- DO.6230.01 Cherry / Wiśnia
- DO.6230.02 Grape / Winogrono
- DO.6231.01 Bubblegum / Guma do żucia
- DO.6231.02 Mint / Mięta
- Pack of 10 pieces / Opak. 10 szt.

**Retainer seater & retainer retriever in case
Zestaw do elast. aparatów retencyjnych w pudełku**

Simple solution for properly seating aligners with imperfect fit.
Proste rozwiązanie dla dokładnego umiejscowienia aparatu retencyjnego.



- DO.6504.01  Mint / Miętowy
- DO.6504.02  Bubble gum / Guma do żucia
- DO.6504.03  Grape / Winogrono
- DO.6504.04  Unscented / Bez zapachu
- DO.6504.05  Orange / Pomarańczowy

Retainer seater 2 pieces + retainer retriever in case
2 nagryzacze + instrument

Relief wax organizer / Stojak na wosk



- Made from strong, high quality clear acrylic
- Removable cover slides on and off for easy dispensing and re-stocking
- Holds 100 boxes



DO.6220.00



Clear relief wax unscented box
Przeźroczysty wosk ostonowy bezzapachowy

For relief against irritation caused by brackets and ligature wires
Wosk przynoszący ulgę pacjentowi podczas noszenia aparatu stałego



Pack of 10 pieces / 1 opak. wosku zawiera 10 pudełeczek jednego koloru



Box color / Kolor pudełka
Code / Kod

Pink / Różowy
DO.6200.01

Clear / Przeźroczysty
DO.6200.02

Silver / Srebrny
DO.6200.03

Clear relief wax scented box
Przeźroczysty wosk ostonowy zapachowy

For relief against irritation caused by brackets and ligature wires
Wosk przynoszący ulgę pacjentowi podczas noszenia aparatu stałego



Pack of 10 pieces / 1 opak. wosku zawiera 10 pudełeczek jednego koloru



Box color / Kolor pudełka
Code / Kod

Blueberry / Jagoda
DO.6206.02

Bubblegum / Guma do żucia
DO.6206.03

Cherry / Wiśnia
DO.6206.05



Box color / Kolor pudełka
Code / Kod

Chocolate / Czekolada
DO.6206.06

Cinnamon / Cynamon
DO.6206.07

Coconut / Kokos
DO.6206.08



Box color / Kolor pudełka
Code / Kod

Cottoncandy / Cukierek
DO.6206.09

Grape / Winogrono
DO.6206.10

Mint / Mięta
DO.6206.11



Box color / Kolor pudełka
Code / Kod

Orange / Pomarańcza
DO.6206.12

Pineapple / Ananas
DO.6206.13



Clear relief wax unscented box Przeźroczysty wosk osłonowy bezzapachowy

For relief against irritation caused by brackets and ligature wires
Wosk przynoszący ulgę pacjentowi podczas noszenia aparatu stałego



Pack of 10 pieces / 1 opak. wosku zawiera 10 pudełeczek jednego koloru



Box color / Kolor pudełka	Clear / Przeźroczysty	Silver / Srebrny	Purple / Purpurowy	Blue / Niebieski
Code / Kod	DO.6204.02	DO.6204.03	DO.6204.05	DO.6204.06



Box color / Kolor pudełka	Green / Zielony	Orange / Pomarańcz	Pink / Różowy
Code / Kod	DO.6204.07	DO.6204.08	DO.6204.09

Clear relief wax scented box Przeźroczysty wosk osłonowy zapachowy

For relief against irritation caused by brackets and ligature wires
Wosk przynoszący ulgę pacjentowi podczas noszenia aparatu stałego



Pack of 10 pieces / 1 opak. wosku zawiera 10 pudełeczek jednego koloru



Scent / Zapach	Apple / Jabłko	Blueberry / Jagoda	Bubblegum / Guma do zucia	Cherry / Wiśnia
Code / Kod	DO.6205.01	DO.6205.02	DO.6205.03	DO.6205.05



Scent / Zapach	Chocolate / Czekolada	Cinnamon / Cynamon	Coconut / Kokos	Cotton candy / Cukierek
Code / Kod	DO.6205.06	DO.6205.07	DO.6205.08	DO.6205.09



Scent / Zapach	Grape / Winogrono	Mint / Mięta	Orange / Pomarańcza	Pineapple / Ananas
Code / Kod	DO.6205.10	DO.6205.11	DO.6205.12	DO.6205.13



Scent / Zapach	Tutti-Frutti / Tutti-Frutti
Code / Kod	DO.6205.16



Color scented wax in clear cases
Kolorowy wosk osłonowy zapachowy

For relief against irritation caused by brackets and ligature wires
Wosk przynoszący ulgę pacjentowi podczas noszenia aparatu stałego



Pack of 10 pieces / 1 opak. wosku zawiera 10 pudełeczek jednego koloru



Wax color / Kolor wosku	Yellow / Żółty	Orange / Pomarańczowy
Scent / Zapach	Lemon / Cytryna	Orange / Pomarańcza
Code / Kod	DO.6203.02	DO.6203.05

Retainer cases classic mini
Pudełka classic mini na retainery

Size / Rozmiar

22 mm	Deep / Głębokość
72 mm	Wide / Szerokość
65 mm	Long / Długość



DO.6321.00
Assorted / Asortyment
Pack of 12 pieces / Opak. 12 szt.



DO.6322.00
Assorted / Asortyment
Pack of 15 pieces / Opak. 15 szt.

Euro retainer cases Maxi
Pudełka ortodontyczne Euro Maxi



DO.6316.00
Assorted colors / Asortyment

Pack of 10 pieces
Opak. 10 szt.



Euro retainer cases Maxi
Pudełka ortodontyczne Euro Maxi

Pack of 10 pieces / Opak. 10 szt.

Size / Rozmiar

38 mm	Deep / Głębokość
76 mm	Wide / Szerokość
64 mm	Long / Długość



DO.6306.01
Sparkle aqua
Metallic morski



DO.6306.02
Sparkle black
Metallic czarny



DO.6306.03
Sparkle blue
Metallic niebieski



DO.6306.04
Sparkle green
Metallic zielony



DO.6306.05
Sparkle purple
Metallic purpurowy



DO.6306.06
Sparkle red
Metallic czerwony



DO.6306.08
Yellow
Żółty



DO.6306.11
Sparkle cool mint
Metallic miętowy



DO.6306.12
Sparkle plum
Metallic śliwkowy



DO.6307.01
Tropical Blue
Fluorescencyjny niebieski



DO.6307.02
Tropical green
Fluorescencyjny zielony



DO.6307.03
Tropical orange
Fluorescencyjny pomarańczowy



DO.6307.04
Tropical pink
Fluorescencyjny różowy



DO.6308.01
Splash
W kleksy



DO.6308.02
Splash kiwi
Kiwi w kleksy



DO.6308.03
Splash ocean
Ocean w kleksy



DO.6308.04
Splash tangerine
Mandarynka w kleksy



DO.6309.01
Glow in the dark
Świecąca w ciemności

DO.6306.00

Assorted colours / Asortyment

- DO.6306.01 Sparkle aqua / Metallic morski
- DO.6306.02 Sparkle black / Metallic czarny
- DO.6306.03 Sparkle blue / Metallic niebieski
- DO.6306.04 Sparkle green / Metallic zielony
- DO.6306.05 Sparkle purple / Metallic purpurowy
- DO.6306.06 Sparkle red / Metallic czerwony
- DO.6307.01 Tropical Blue / Fluorescencyjny niebieski
- DO.6307.02 Tropical green / Fluorescencyjny zielony
- DO.6307.03 Tropical orange / Fluorescencyjny pomarańczowy
- DO.6307.04 Tropical pink / Fluorescencyjny różowy

Pack of 10 pieces / Opak. 10 szt.



Euro retainer cases Midi
Pudełka ortodontyczne Euro Midi



DO.6300.02
Sparkle black /
Metallic czarny



DO.6300.03
Sparkle green /
Metallic zielony



DO.6300.05
Sparkle purple /
Metallic purpurowy



DO.6300.06
Sparkle red /
Metallic czerwony



DO.6301.01
Tropical Blue /
Fluorescencyjny niebieski



DO.6301.02
Tropical green /
Fluorescencyjny zielony



DO.6301.03
Tropical orange /
Fluorescencyjny pomarańczowy



DO.6301.04
Tropical pink /
Fluorescencyjny różowy



DO.6303.01
Glow in the dark /
Świecące w ciemności

- DO.6300.00**
Assorted colours / Asortyment
- DO.6300.02 Sparkle black / Metallic czarny
 - DO.6300.03 Sparkle green / Metallic zielony
 - DO.6300.05 Sparkle purple / Metallic purpurowy
 - DO.6300.06 Sparkle red / Metallic czerwony
 - DO.6301.01 Tropical Blue / Fluorescencyjny niebieski
 - DO.6301.02 Tropical green / Fluorescencyjny zielony
 - DO.6301.03 Tropical orange / Fluorescencyjny pomarańczowy
 - DO.6301.04 Tropical pink / Fluorescencyjny różowy
 - DO.6302.01 Splash / W kleksy
 - DO.6303.01 Glow in the dark / Świecące w ciemności

Pack of 10 pieces / Opak. 10 szt.

Size / Rozmiar

31 mm	Deep / Głębokość
76 mm	Wide / Szerokość
64 mm	Long / Długość



Slim-Line retainer cases
Slim-Line Pudełka ortodontyczne



DO.6311.01
Sparkle Black / Metallic czarny



DO.6311.04
Sparkle Green / Metallic Zielony



DO.6311.05
Sparkle Purple / Metallic Purpurowy



DO.6311.06
Sparkle Red / Metallic Czerwony



DO.6312.01
Tropical Blue / Fluorescencyjny niebieski



DO.6312.02
Tropical Green / Fluorescencyjny Zielony



DO.6312.03
Tropical Orange / Fluorescencyjny pomarańczowy



DO.6312.04
Tropical Pink / Fluorescencyjny różowy



DO.6311.13
Sparkle Cool Mint / Metallic miętowy



DO.6311.14
Sparkle Plum / Metallic śliwkowy

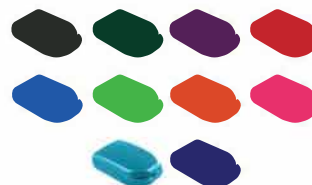

DO.6311.00
Assorted / Asortyment
Pack of 10 pieces / Opak. 10 szt.

Pack of 10 pieces / Opak. 10 szt.

Size / Rozmiar

35 mm	Deep / Głębokość
50 mm	Wide / Szerokość
85 mm	Long / Długość

Retainer cases classic Midi / Pudełka protetyczne Classic Midi



Pack of 10 pieces / Opak. 10 szt.

Size / Rozmiar

32 mm Deep / Głębokość
70 mm Wide / Szerokość
60 mm Long / Długość



Each / Sztuka

DO.6350.00M
Mirror for classic retainer case
Lusterko do pudełka protetycznego



Color / Kolor	Black / Czarne	Blue Dark / Ciemnoniebieskie	Blue Light / Jasnoniebieskie	Green Fluorescent / Fluorescencyjna zieleń
Midi	DO.6320.01	DO.6320.02	DO.6320.03	DO.6320.04
Midi with mirror z lusterkiem	DO.6350.01	DO.6350.02	DO.6350.03	DO.6350.04



Color / Kolor	Orange / Pomarańczowe	Pink Hot / Ostry róż	Purple / Purpurowe	Red / Czerwone
Midi	DO.6320.05	DO.6320.06	DO.6320.07	DO.6320.08
Midi with mirror z lusterkiem	DO.6350.05	DO.6350.06	DO.6350.07	DO.6350.08



Color / Kolor	Violet / Fioletowe	Yellow / Żółte	Assorted / Mix kolorów
Midi	DO.6320.10	DO.6320.11	DO.6320.00
Midi with mirror z lusterkiem	DO.6350.10	DO.6350.11	DO.6350.00

Orthodontic retainer or bleaching tray cases / Pudełka ortodontyczne na retainery i szyny wybielające



Pack of 10 pieces
Opak. 10 szt.



DO.6314.00
Assorted colors / Asortyment



	Without strap Bez paska	With strap Z paskiem
Color / Kolory	Code / Kod	Code / Kod
Blue / Niebieski	DO.6250.02	DO.6251.02
Clear / Przezroczysty	DO.6250.03	DO.6251.03
Green / Zielony	DO.6250.04	DO.6251.04
Silver / Srebrny	DO.6250.06	DO.6251.06
Yellow / Żółty	DO.6250.07	DO.6251.07

- The first truly breathable mouth guard
 - Protect lips, cheeks and gums from contact with braces while playing sports
 - Three breathing vents to maximise airflow
 - Tongue guard protects the tongue from protruding through the vents
 - Comfortable and easy to wear
 - Can be heated and customised for each patient
- Pierwszy nieutrudniający oddychania ochroniacz do warg
 - Ochronia wargi, policzki i dziąsła przed kontaktem z zamkami podczas uprawiania sportu.
 - Trzy otwory ułatwiające przepływ powietrza.
 - Skutecznie ochronia język
 - Wygodny i łatwy w użyciu.
 - Pod wpływem ciepła dopasowuje się do jamy ustnej pacjenta

Functional vestibular appliance- Schönherr's plates / Płytki przedsionkowe Schönherra



DO.8090.01
Small – under 3 years
Mała – dla dzieci poniżej 3 lat



DO.8090.02
Medium – 3 to 5 years
Średnia – dla dzieci 3-5 lat



DO.8090.03
Large – 5 to 7 years
Duża – dla dzieci 5-7 lat

Intraoral & extraoral elastic band case / Pudełeczka na wyciągi wewnętrzne lub zewnętrzne z nakładaczem

Pack of 10 pieces / Opak. 10 szt.



DO.5986.00
Assorted / Asortyment





ICON

Interdental brushes standard / Szczoteczki do przestrzeni międzyzębowych standard

High tensile strength, plastic coated, stainless steel wire at the core prevents the brushes from bending. Brush is also fully flexible and after bending will retain its original shape. The brush and handle are manufactured as a complete unit so there is no need to assemble. Additionally each brush has its own hygienic cap which can also be used as a handle extension (except ID114 and ID115).

Stalowy rdzeń szczoteczki bardzo wytrzymały, nie łamie się nawet po wielokrotnym zgięciu, solidnie umieszczony w ergonomicznym uchwycie. Elastyczne, nylonowe włosie szczoteczki zawsze powraca do swojego początkowego kształtu. Szczoteczki posiadają nakładkę ochronną, która może służyć jako przedłużenie uchwytu.

Pack of 8 pieces / Opak. 8 szt.

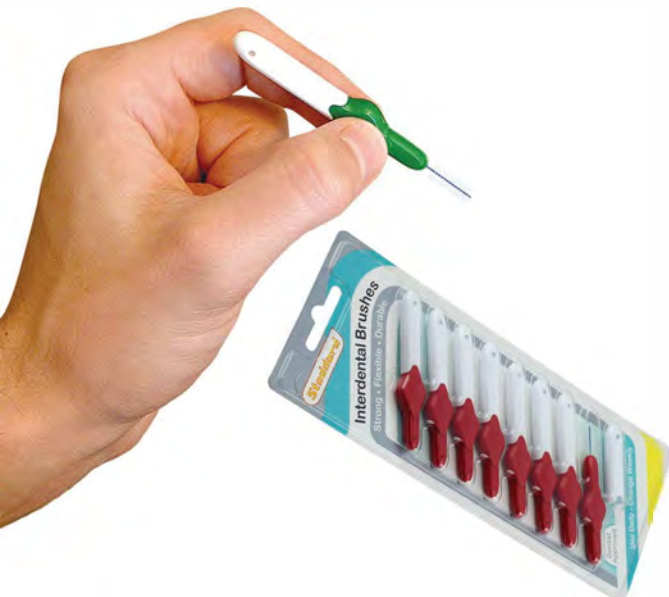

Size / Rozmiar	XXXXF	XXXF	XXF	XF	F	M	L	XL
Ø mm	1,8	2,0	2,5	3,0	3,5	5,0	6,0	9,0
L mm	12,0	12,5	12,0	13,0	13,0	13,0	16,0	19,0
Color / Kolor	Pink	Orange	Red	Blue	Yellow	Green	Purple	Grey
	Różowe	Pomarańczowe	Czerwone	Niebieskie	Żółte	Zielone	Purpurowe	Szare
Code / Kod	ID121	ID120	ID119	ID118	ID117	ID116	ID115	ID114

Tandex Flexi interdental brush / Szczoteczki do przestrzeni międzyzębowych

Each / Sztuka



Size / Rozmiar	X-Micro	Micro fine	Ultra fine	Superfine	X-fine	Fine	X-fine tapere / stożkowe	Stożkowe	Medium
Ø mm	2,5	2,5	2,5	3,0	3,0	3,5	3 - 5	3 - 6	8,0
Wire thickness / Grubość drutu	0,35	0,40	0,45	0,50	0,60	0,70	0,80	1,00	1,20
Color / Kolor	Turquoise	Coral	Tangerine	Ruby	Aqua	Lemon	Lilac	Lime	Violet
	Morskie	Różowe	Pomarańczowa	Czerwona	Niebieska	Żółte	Lilowe	Zielone	Ciemnofioletowe
Code / Kod	TF-ID200	TF-ID201	TF-ID202	TF-ID203	TF-ID204	TF-ID205	TF-ID206	TF-ID207	TF-ID208

ORAL-B Super Floss / Nić ORAL-B Super Floss



- 1 Ideal for braces, bridges and wide spaces
- 2 Stiffened end to floss under appliances
- 3 Spongy-floss to clean around appliances and in wide spaces
- 4 Regular floss to remove plaque under gumline
- 5 Pre-cut strands

DH.1000.02
Pack of 50 pieces
Opak. 50 szt.

- 1 Do czyszczenia mostów, aparatów ortodontycznych i większych przestrzeni międzyzębowych
- 2 Usztywniony koniec ułatwia wprowadzanie nici pod przęsło mostu lub aparatu ortodontycznego
- 3 Puszysta część służy czyszczeniu miejsc wokół mostów i aparatów oraz większych przestrzeni międzyzębowych
- 4 Standardowa nić dentylistyczna usuwa płytkę nazębną poniżej linii dziąseł
- 5 W pojemniku znajduje się 50 odmierzonych odcinków nitki dla łatwiejszego dozowania

Tongue cleaner / Szczoteczka do czyszczenia języka



DH.2200.0U



End Tufted Brush / Szczoteczki jednopęczkowe

The brush has been developed in order to clean interstitially tooth by tooth.
The brush is equipped with a small ergonomically designed nylon tuft.

Idealna do czyszczenia pojedynczych zębów, okolic przyszykowych, bruzd zębowych oraz stałych aparatów ortodontycznych. Zakończona ergonomicznie zaprojektowanym małym nylonowym pęczkiem, pozwala na delikatne i efektywne czyszczenie.

CS 1006
single 6mm

CS 1009
single 9mm

CURAPROX

MIND THE GAP!

SUNSTAR
GUM
HEALTHY GUMS. HEALTHY LIFE.™

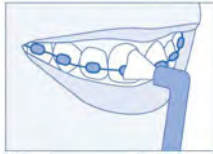

DH.2002.01

DH.2002.02

DH.2002.03

Orthodontic V-Trim toothbrushes
Szczoteczki ortodontyczne V-Trim

CURAPROX
MIND THE GAP!

SUNSTAR
GUM
HEALTHY GUMS. HEALTHY LIFE.™

Oral-B



DH.2011.01
Curaprox CS 5460



DH.2011.02
Gum Butler 124



DH.2011.03
Oral B

Orthodontic dual-head V-Trim toothbrushes
Podwójne szczoteczki ortodontyczne (z końcówką do czyszczenia przestrzeni międzyzębowych)



DH.2010.00 Blue / Niebieska
DH.2010.01 Green / Zielona
DH.2010.02 Purple / Purpurowa
DH.2010.03 Red / Czerwona

Orthodontic V-Trim travel toothbrushes
Podróżne szczoteczki ortodontyczne V-Trim



DH.2020.00 Blue / Niebieska
DH.2020.01 Green / Zielona
DH.2020.02 Purple / Purpurowa
DH.2020.03 Red / Czerwona

Orth
Szc:

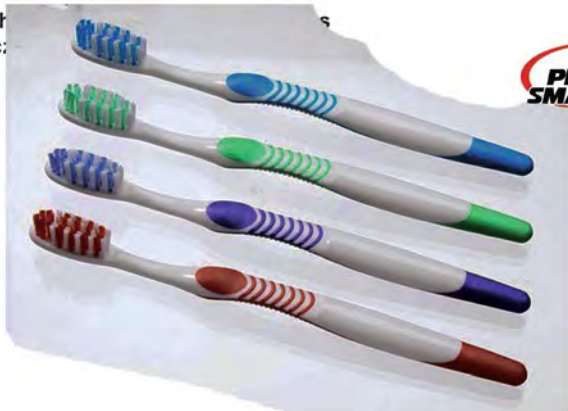

DH.2012.00 Blue / Niebieska
DH.2012.01 Green / Zielona
DH.2012.02 Purple / Purpurowa
DH.2012.03 Red / Czerwona

Disposable orthodontic V-Trim Prepasted toothbrush
Szczoteczki ortodontyczne jednorazowe V-Trim z pastą do zębów

Pack of 144 pieces / Opak. 144 szt.

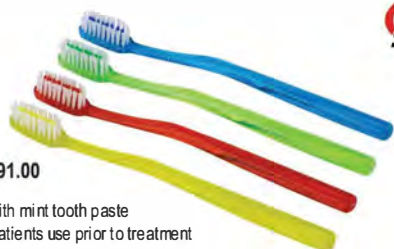

DH.2091.00

Prepasted with mint tooth paste
Perfect for patients use prior to treatment

Pasta o smaku miętowym
Doskonale w sytuacjach awaryjnych

Toothbrush covers
Ostonki na główki szczoteczek manualnych

Pack of 144 pieces / Opak. 144 szt.



DH.2900.00

Denture brush
Szczoteczka do protez



DH.2300.00



Teen toothbrushes
Szczoteczki do zębów Teen



DH.2015.01 Blue / Niebieska
DH.2015.02 Green / Zielona
DH.2015.03 Orange / Pomarańczowa
DH.2015.04 Yellow / Żółte

Orthodontic care kits / Zestawy higieniczne

Give your patients everything they need to get through the "ordeal" of having to wear braces. They're a great way to show you care while encouraging oral hygiene during treatment so that patients get the most value out of their braces.

Zaoferuj swojemu pacjentowi wszystko to czego potrzebuje aby mu wynagrodzić trud noszenia aparatu stałego. To doskonały sposób okazania troski o pacjenta i zachęta do dbałości o higienę jamy ustnej.

Kit-III in plastic case / Zestaw w plastikowym etui



Orthodontic Care Kit / Zestaw higieniczny

DH.2000.04 Blue / Niebieski
DH.2000.05 Green / Zielony
DH.2000.06 Purple / Purpurowy
DH.2000.07 Red / Czerwony

Contents, 1 each / Zawiera po 1 sztuce:

Dual head V-Trim brush / Szczoteczka
V-Trim travel brush / Szczoteczka podróżna
Interproximal brush / Szczoteczka do przestrzeni międzyzębowych
3-minutes timer / 3 min. "klepsydra"
Mint wax / Wosk miętowy
Floss threaders / Igła do nici dentystycznej
15 yard mint floss spool / Nić dentystyczna na szpulce
Mouth mirror / Lusterko z rączką



Orthodontic care kits / Zestawy higieniczne

Give your patients everything they need to get through the "ordeal" of having to wear braces. They're a great way to show you care while encouraging oral hygiene during treatment so that patients get the most value out of their braces.

Zaferuj swojemu pacjentowi wszystko to czego potrzebuje aby mu wynagrodzić trud noszenia aparatu stałego. To doskonały sposób okazania troski o pacjenta i zachęta do dbałości o higienę jamy ustnej.

Kit-II in plastic bottle / Zestaw w plastikowym bidonie



Contents, 1 each / Zawiera po 1 sztuce:
Dual head V-Trim brush / Szczoteczka
V-Trim travel brush / Szczoteczka podróżna
Interproximal brush / Szczoteczka do przestrzeni międzyzębowych
Mint wax / Wosk miętowy
Floss threaders / Igła do nici dentystycznej
15 yard mint floss spool / Nić dentystyczna na szpulce



Orthodontic Care Kit / Zestaw higieniczny
DH.2001.00 Blue / Niebieski
DH.2001.01 Green / Zielony
DH.2001.02 Purple / Purpurowy

Kit-IV in plastic pouch / Zestaw w plastikowym etui



Contents, 1 each / Zawiera po 1 sztuce:
V-Trim brush / Szczoteczka V-Trim
V-Trim travel brush / Szczoteczka podróżna
Interproximal brush / Szczoteczka do przestrzeni międzyzębowych
3-minutes timer / 3 min. "klepsydra"
Orthodontic wax / Wosk ortodontyczny
15 yard mint floss spool / Nić dentystyczna na szpulce
Mouth mirror mixing spatula / Lusterko z rączką



Orthodontic Care Kit / Zestaw higieniczny
DH.2003.00 Blue / Niebieski
DH.2003.01 Pink / Różowy

Kit-IV in plastic pouch / Zestaw w plastikowym etui



Contents, 1 each / Zawiera po 1 sztuce:
V-Trim brush / Szczoteczka V-Trim
V-Trim travel brush / Szczoteczka podróżna
Interproximal brush / Szczoteczka do przestrzeni międzyzębowych
3-minutes timer / 3 min. "klepsydra"
Orthodontic wax / Wosk ortodontyczny
15 yard mint floss spool / Nić dentystyczna na szpulce
Mouth mirror mixing spatula / Lusterko z rączką



Orthodontic Care Kit / Zestaw higieniczny
DH.2003.02 Blue / Niebieski
DH.2003.03 Green / Zielony
DH.2003.04 Purple / Purpurowy
DH.2003.05 Red / Czerwony

Dental water flossers / Irygator stomatologiczny

waterpik®



DH.2500.01



Product Features

- 7 Tips
- Advanced Pressure Control System With 10 Settings
- Reservoir Capacity Of 90+ Seconds
- Pause Button On Handle
- 360-Degree Tip Rotation
- Smaller And Quieter Than Previous Models
- Covered Reservoir With Built-In Tip Storage
- Compatible With 120VAC/60Hz Outlets, For Use In North America Only
- Two-Year Warranty

Opis

Waterpik to nowoczesny irygator w 93% skuteczniejszy w profilaktyce zapalenia dziąseł od tradycyjnych metod czyszczenia nitką dentystyczną. Badania naukowe dowiodły że po 28 dniach używania irygatora nastąpiło w 40%-93% obniżenie krwawienia i zapalenia dziąseł. Zdrowsze dziąsła już po 14 dniach. Usuwa bakterie głęboko między zębami i poniżej dziąseł, gdzie czyszczenie tradycyjną szczoteczką nie daje rezultatów. Masuje dziąsła, nadając w efekcie ich silny i zdrowy wygląd

Idealny do czyszczenia wokół stałych aparatów ortodontycznych, dzięki zastosowaniu specjalnej końcówki.
10 stopni regulacji ciśnienia (od 5 do 90 Psi).
Nowy wygląd oraz 20% cichszy niż poprzednie modele.
Zbiornik z pokrywą ułatwia utrzymać go w czystości i przechowywać załączone akcesoria.
Dwa lata gwarancji



DH.2500.03



Classic Jet tip
końcówki klasyczne
do irygacji



Orthodontic tip
Końcówka ortodontyczna



Plaque Seeker tip
końcówka do czyszczenia
implantów, mostów, koron



Pik Pocket tip
końcówka do irygacji
poddziąsłowej



Toothbrush tip
końcówka szczoteczka
do zębów



Tongue cleaner tip
końcówka do czyszczenia języka



Expansion screws / Śruby rozszerzające

Micro Series

Double-guidance expansion screws for multiple use.
Podwójne śruby prowadzące o szerokim zastosowaniu.

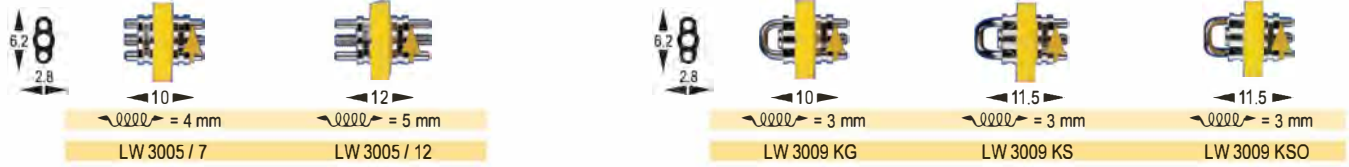

Skeleton-type sector screws for use as distal screws and for single-tooth movements.
Stable U-bow retention, straight or bent.
Śruby szkieletowe, sekcyjne do przesuwania poszczególnych zębów, proste lub kątowe.

Standard Series

Skeleton-type sector screws for use as distal screws and for single-tooth movements. Stable U-bow retention, straight or bent.
Śruby szkieletowe, sekcyjne do przesuwania poszczególnych zębów, proste lub kątowe.

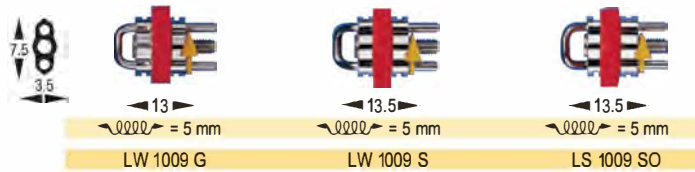

Traction screws for closing gaps. Stable U-bow retention straight or bent.
Śruby trakcyjne, ściągające do zamykania przestrzeni międzyzębowych, proste lub kątowe.

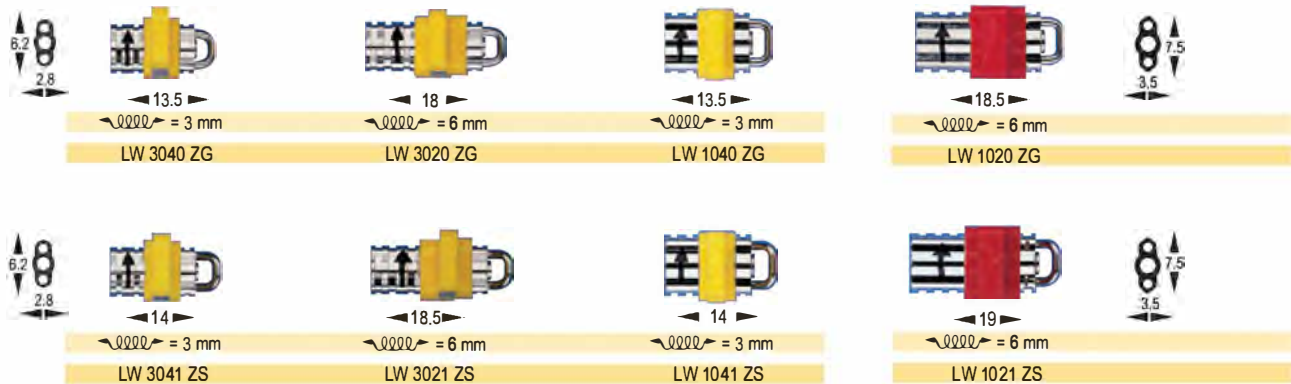

Stable expansion screws for the maxilla with retention drill holes.
Śruby szkieletowe, rozszerzające z zamkniętym otworem, typowe dla szczęki.

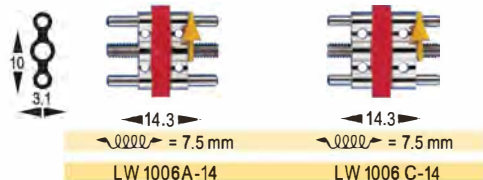

Standard expansion screws
Śruby rozszerzające standard

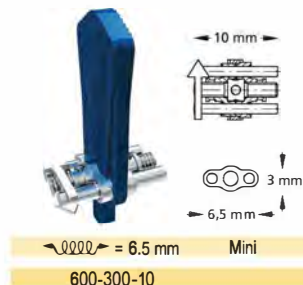

Skeleton design
Holes in body of screws for better retention in acrylic
Built-in stops prevent screws from coming apart
With expansion screw key straight, small – standard

Stable expansion screws for the mandible with retention drill holes.
Śruby szkieletowe, rozszerzające z zamkniętym otworem, typowe dla żuchwy.

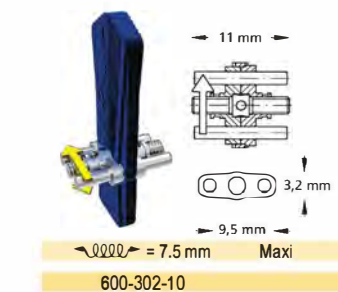
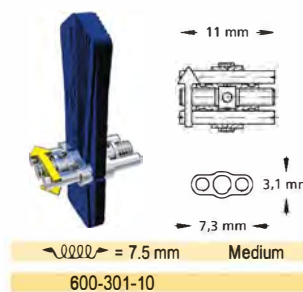
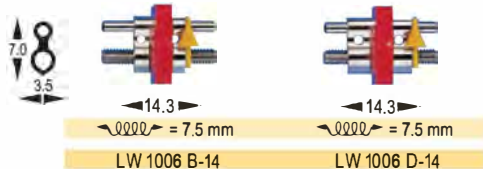



Expansion screws / Śruby rozszerzające

Multiple section screws by Bertoni / Śruby Bertoni

Combined transversal and protrusion screw for 2 or 3 independently adjustable sectors.

Śruby poprzeczno-protruzyjne z 2 lub 3 niezależnie działającymi sekcjami, trójkierunkowe.

LEWADENTAL



Special screws / Śruby specjalne

Fan-shaped screw for asymmetric expansion of the maxilla. Śruba zawiasowa górna do przesuwania zębów w poprzek łuku zębowego w odcinku przednim szczęki.

Mandibular bow screws for transversal expansion of the mandibular anterior arch.

Śruby zawiasowe dolne do przesuwania zębów w poprzek łuku zębowego w odcinku przednim żuchwy.

Stable expansion screw for the upper jaw. Śruba Weise'a do leczenia przodozgrzyzu.

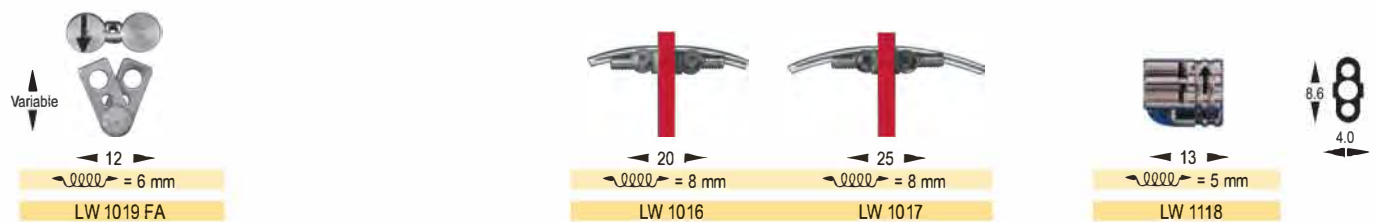

Palatal suture expansion screws / Śruby do podniebiennych procesów rozszerzających

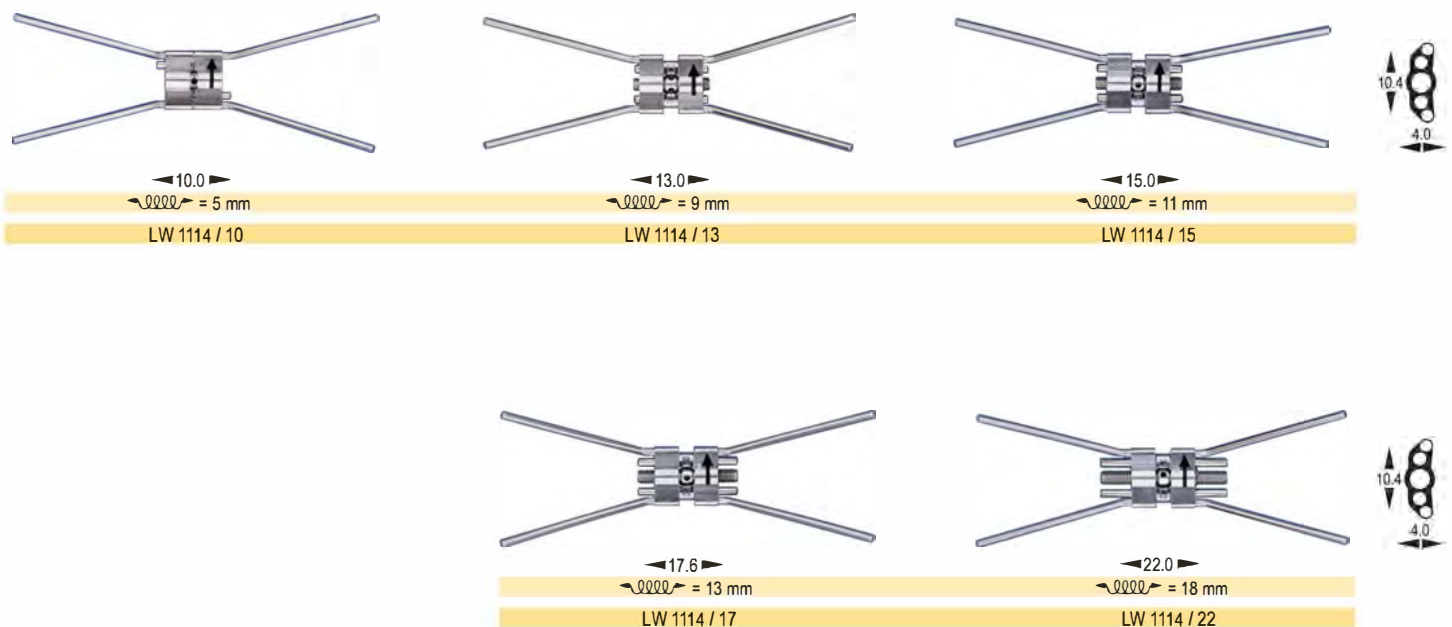



Laboratory wires / Drut protetyczny

High quality chromium-nickel dental wires, quality soft, hard and spring hard.
Wysokiej jakości drut protetyczny chromowo-niklowy – miękki, twardy, sprężysto – twardy.



Size Rozmiar	Soft Miękki	Hard Twardy	Spring hard Sprężysto – twardy	Length Długość
0,4 mm	L 704	L 804	L 904	50 m
0,5 mm	L 705	L 805	L 905	50 m
0,6 mm	L 706	L 806	L 906	40 m
0,7 mm	L 707	L 807	L 907	30 m
0,8 mm	L 708	L 808	L 908	20 m
0,9 mm	L 709	L 809	L 909	10 m
1,0 mm	L 710	L 810	L 910	10 m
1,1 mm	L 711	L 811	L 911	10 m
1,2 mm	L 712	L 812	L 912	10 m



Remanium® wires / Drut Remanium®

Size Rozmiar	Spring hard Sprężysto – twardy	Length Długość
0,7 mm	523-070.00	30 m
0,8 mm	523-080.00	20 m
0,9 mm	523-090.00	20 m

Thermoform sheets / Płytki termoformowalne



CRYSTAL PLATE 0,5mm - PVC
• Whitening / Fluoride application tray.

CRYSTAL PLATE 0,75 / 1,0 / 1,5 / 2,0
• Bite plate (bruxism) / Base plate;
• Orthodontic Aligners;
• Space retainer Try-on of wax Surgical Guide.



SOFT PLATE 1,0mm - EVA
• Whitening / Fluoride application tray.

SOFT PLATE 2,0mm - EVA
• Mouth protector / Miorelaxing

SOFT (EVA-Borrachoid) 3,0 / 4,0mm
• Mouthguard / Miorelaxing

Thickness / Grubość	Round / okrągłe ø 127 mm	Square / Kwadratowe 127 x 127 mm
0.50 mm / .020"	3A GS020R	3A GS020
0.75 mm / .030"	3A GS030R	3A GS030
1.00 mm / .040"	3A GS040R	3A GS040
1.50 mm / .060"	3A GS060R	3A GS060
2.00 mm / .080"	3A GS080R	3A GS080

Thickness / Grubość	Round / okrągłe ø 127 mm	Square / Kwadratowe 127 x 127 mm
0.50 mm / .020"	3A GB020R	3A GB020
1.00 mm / .040"	3A GB040R	3A GB040
1.50 mm / .060"	3A GB060R	3A GB060
2.00 mm / .080"	3A GB080R	3A GB080
3.00 mm / .0120"	3A GM120R	3A GM120
4.00 mm / .0160"	3A GM160R	3A GM160

Orthodontic Instruments / Instrumenty ortodontyczne





Instruments for "Fixed Appliance Technique" Narzędzia do techniki aparatów stałych

Measuring instruments / Instrumenty do pomiarów

Vernier caliper / Suwmiarka



DO.170.000
Beerendonk

Vernier with long and fine tips for intraoral measurements.
Suwmiarka z długimi, cienkimi końcówkami do pomiarów wewnątrzustnych.

Vernier caliper / Suwmiarka



DO.172.000
Falcon

Double sided, for inner and outer measurements
Dwustronna, do pomiarów wewnętrznych i zewnętrznych

Bow divider / Cyrkiel



DO.151.000
Falcon

To measure tooth width, bracket distance to the incisal edge etc.
Do mierzenia szerokości zębów, odległości zamka od brzegu siecznego, itp.

Orthodontic bow compass Cyrkiel ortodontyczny

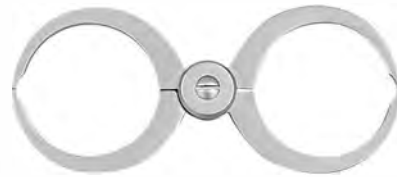

DO.175.000
Falcon

To measure tooth width, bracket distance to the incisal edge etc.
Do mierzenia szerokości zębów, odległości zamka od brzegu siecznego, itp.

Orthodontic ruler / Linijka ortodontyczna

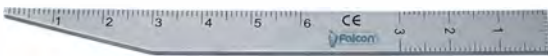

DO.160.000
Bernklau

Perfect for all diagnostic measurements, both intraoral and on the model.
Idealna do pomiarów diagnostycznych, zarówno wewnątrzustnych jak i na modelu

Rulers stainless steel / Linijki ze stali nierdzewnej



BA.225.150 150 mm / 6"



BA.225.300 300 mm / 12"

Dynamometer / Dynamometr

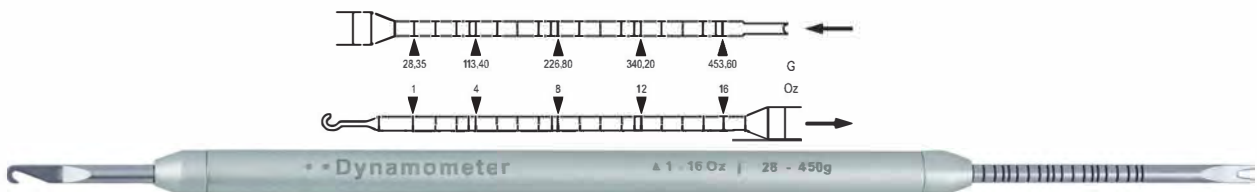

DO.180.000

"High precision gauge for measuring tensile and compression forces exerted by springs and elastics for a maximum range of 16 oz. (453g). It is calibrated with 1 oz. single line and 4 oz. double line increments."

"Przyrząd do pomiaru siły naciągu wyciągów elastycznych i sprężynek. Maksymalna siła - 16 oz. (453g). Dynamometr jest kalibrowany, jedno nacięcie oznacza 1oz, dwa nacięcia 4oz."

IPR distance control gauge set / IPR linijka do mierzenia dystansu

Manual stainless steel instrument for the measurement and control of tooth distances heated during IPR protocols

During orthodontic treatments using the interproximal stripping process, predefined and measured interdental spaces must be created. With the stripping method, measurable and calibrated spaces are created through the removal of dental tissue in order to obtain exactly the space necessary for the movement of teeth into a harmonious and correct position.



DO.299.000

Interproximal reduction strips / Paski separacyjne

M.I.R. is indicated for use in interproximal and contact reduction, mesial/distal finishing and contouring, crown and bridge cement removal and cleanup.

Each / Sztuka



Single sided perforated / Jednostronne perforowane

Code / Kod	Grit size /	Color / Kolor
DO.299.051	Extra fine	Yellow
DO.299.052	Fine	Red
DO.299.053	Medium	Blue
DO.299.054	Coarse	Green
DO.299.055	Extra coarse	Black



Instruments for bands and buccal tubes / Instrumenty do pierścieni i rurek

Band seating instruments / Nagryzacz do pierścieni



Autoclavable
Możliwość sterylizacji w autoklawie

Band seating instrument with hard metal triangular serrated tip, autoclavable
Narzędzie do nakładania pierścieni z trójkątnym ząbkowanym trzpieniem z twardego metalu, możliwość sterylizacji w autoklawie



DO.125.020 Green / Zielony
DO.125.030 Orange / Pomarańczowy

DO.125.040 Purple / Purpurowy
DO.125.050 Red / Czerwony
DO.125.080 White / Biały



DO.125.000 Ergo blue / Ergo niebieski



DO.125.010 Blue / Niebieski



Autoclavable
Możliwość sterylizacji w autoklawie

Deluxe Band seating instruments (Bite sticks)
Deluxe Nagryzacz do pierścieni

High heat resistant band seating instruments (Bite sticks) withstand temperatures up to 188 °C

Nagryzacz odporne na wysoką temperaturę, sterylizacja do 188 °C



DO.126.000
Standard triangular tip
Końcówka w kształcie standardowego trójkąta



DO.126.010
Reverse triangular tip
Końcówka w kształcie odwróconego trójkąta



DO.126.020
Circular tip
Końcówka w kształcie okręgu



DO.126.030
Star shaped tip
Końcówka w kształcie gwiazdy

Buccal tube tweezers
Pensety do zakładania rurek



Fine pointed tips firmly grip buccal tube within slot for accurate placement.

Cienkie końcówki pewnie chwytają słot w rurce i umieszczają w odpowiednim miejscu



DO.227.120 120mm
DO.227.135 135 mm
Keat



DO.228.125 125mm
DO.228.135 135 mm
Falcon

Band pusher
Dociskacz pierścieni



Band pusher with serrated rectangular tip for good transfer of force when positioning bands.

Narzędzie Mershon z ząbkowaną prostokątną końcówką do dociskania pierścieni, zapewniającą dobre przeniesienie siły nacisku



DO.120.010
Mershon

Band pushers - scalers
Dopychacz pierścieni - sierpy

Sharp scaling tip on one end and serrated band pusher on the other.
Ostry sierp do kamienia nazębnego i dociskacz pierścieni z ząbkowaną końcówką



DO.130.010



DO.130.014



Instruments for "Fixed Appliance Technique" Narzędzia do techniki aparatów stałych

Disc safety guard set Zestaw ochraniaczy do tarczy ściernej



Protects patients gums, lips and cheeks from rotating discs.

Ochronia dziąsła, policzki i wargi pacjenta przed wirującą tarczą.

DO.300.000
Contents / Zawiera:
1 x Shaft / Tuleja
1 x 8mm Guard / Ochraniacz
1 x 16mm Guard / Ochraniacz
1 x 22mm Guard / Ochraniacz



Instruments for interdental stripping Instrumenty do międzyzębowej redukcji szkliwa

Manual interdental stripper handle
Trzymadło do pasków separacyjnych

Securely holds all types of abrasive strips
Opracowane dla pewnego chwytania pasków ściernych



DO.298.000

Abrasive strips Paski separacyjne



DO.299.041
Single sided, 4mm x 150mm
Jednostronne, 4mm x 150mm

Pack of 12 pieces
Opak.12 szt.



DO.299.042
Double sided, 4mm x 150mm
Dwustronne, 4mm x 150mm

Pack of 12 pieces
Opak.12 szt.



DO.299.043
Single sided perforated, 4mm x 150mm
Jednostronne perforowane, 4mm x 150mm

Pack of 6 pieces
Opak.6 szt.

Gum flap retractor Odciągacz płata dziąsła



Useful instrument for lifting gum while banding of second molar.

DO.145.010

Praktyczne narzędzie do odciągania płata dziąsła podczas nakładania pierścienia na drugi ząb trzonowy.

Instruments for D.B. brackets / Instrumenty do zamków D.B.

Bracket positioning gauge Pozycjoner do zamków



Facilitate bracket positioning to exact desired distance by measuring its height, from slot to incisal/occlusale surface of tooth

Pozwala na precyzyjne ustawienie zamka, mierząc odległość pomiędzy slotem zamka a brzegiem siecznym zęba



Universal for both .018" or .022" slot brackets.
Four different heights for bracket positioning: 3.5, 4, 4.5, & 5 mm

Uniwersalne narzędzie do zamków o slotach .018" i .022" z czterema wysokościami położenia zamka: 3,5; 4; 4,5; 5 mm.

DO.200.010
Boone



Instruments for D.B. brackets / Instrumenty do zamków D.B.

Falcon bracket positioning gauges
Pozycjonery do zamków Falcon



Four different heights for bracket positioning: 3.5, 4, 4.5, & 5 mm
Two different models for .018" or .022" slot brackets, anodized aluminum

Cztery wysokości położenia zamka: 3,5; 4; 4,5; 5 mm,
Dwa modele dla zamków o slotach .018" i .022",
aluminium anodowane, możliwość sterylizacji w autoklawie



DO.205.018
For .018" slot brackets dla zamków .018"



DO.205.022
For .022" slot brackets dla zamków .022"

Bracket placer for posterior teeth
Penseta do zakładania zamków na zębach trzonowych



Very helpful instrument for placing D.B.brackets from bicuspids to molars, the small head offers excellent view.

Niezawodny instrument do zakładania zamków D.B. na zębach przedtrzonowych i trzonowych. Mała "główka" pensety zapewnia doskonale pole widzenia.



DO.209.010

Adhesive removers / Instrumenty do usuwania kleju

For removing residue of adhesive from tooth after removal of D.B. brackets
Usuwanie pozostałości kleju z zębów po zdjęciu zamków



Autoclavable
Możliwość sterylizacji w autoklawie



6 mm solid handle
6 mm pełny uchwyt



DO.235.010



soft and sure grip



DO.235.014

Orthodontic utility plier for brackets placement
Penseta do zakładania zamków z lusterkim

Laser printed gauge 4.0 mm - 5.0 mm , 3.5 mm - 4.5 mm
Laserowo oznaczona podziałka 4.0 mm - 5.0 mm, 3.5 mm - 4.5 mm



Probe narrow tips
Sonda wąskie końcówki

SDV69
150mm

Front surface mirror 22 mm
Lusterko przedniopowierzchniowe ø 22 mm

Ergonomic – engineered for comfort while working
Time earning – no need to change tool during brackets positioning lowering costs –
one tool instead of four Full attention to the patient – no need to turn head for tool replacing

Patent released to Dr. Stefano Di Vecchio, Patent no RM2000 U000 150



Instruments for "Fixed Appliance Technique" Narzędzia do techniki aparatów stałych

Instruments for D.B. brackets / Instrumenty do zamków D.B.

Bracket placing tweezers Pensety do zakładania zamków



DO.210.135
135mm



DO.217.135
135mm



DO.220.110
110mm

Bracket tweezers with slot aligner Pensety do zakładania zamków z regulatorem slotów



Bracket holder on one end and slot aligner on the other.
The rear end fits into the bracket slot for accurate placement.

Pozycjoner na końcu pensety pozwala na dokładne ustawienie zamka.
Przednia część pensety służy do chwytania zamków.



Fig. 1
DO.213.135
135mm



Fig. 2
DO.214.135
135mm



Fig. 3
DO.215.135
135mm

Tungsten carbide debonding burs Wiertła z węgla spiekane do usuwania kleju



DO.6180.00

Size / Rozmiar \varnothing 1/10 mm OAL 19 mm 014
C21R 500.314.137.006... 014



DO.6181.00

Size / Rozmiar \varnothing 1/10 mm OAL 19 mm 014
CF134 500.314.164.071... 014



DO.6182.00

Size / Rozmiar \varnothing 1/10 mm OAL 19 mm 016
C23R 500.314.194.006... 016

Instruments for "Fixed Appliance Technique" Narzędzia do techniki aparatów stałych



Elastic ligature applicators Instrumenty do nakładania ligatur elastycznych

For easy placement of elastic ligatures under bracket tie wings.
Umożliwiają łatwe założenie ligatur elastycznych pod skrzydełka zamka.

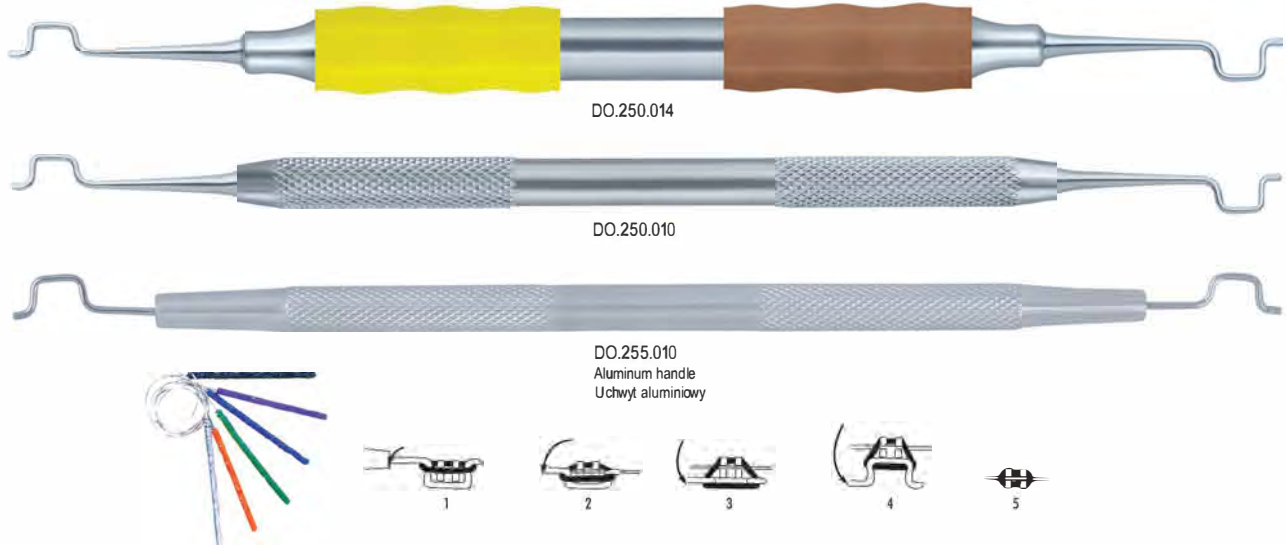

Elastomeric ligature removing instruments Instrumenty do usuwania ligatur elastycznych

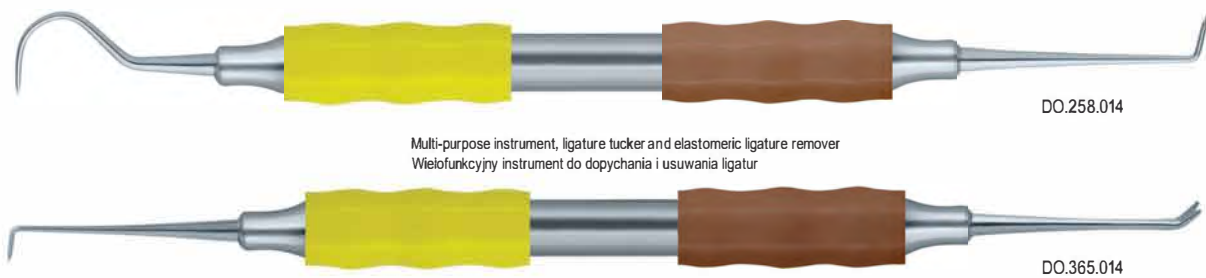

Ligature tuckers Dopychacze ligatur (widelce)

Used to tuck metal ligatures, also useful for inserting arch wires into bracket slots and applying elastic chains. Straight end is for anterior use and angled of posterior
Niezawodne instrumenty do dociskania ligatur metalowych, umieszczania luków w slotach zamka oraz zakładania łańcuszków elastycznych.





Instruments for "Fixed Appliance Technique" Narzędzia do techniki aparatów stałych

Elastic ligature placing forceps

Kleszczyki do nakładania ligatur elastycznych



Elastic ligature placing forceps with hook
Excellent for placing elastic ligatures, hook on tip provides non-slip grip of any type of elastomeric.

Kleszczyki z haczykiem do nakładania ligatur elastycznych
Doskonałe narzędzie do nakładania ligatur elastycznych, elastomery "nie wyslizgują się" dzięki haczykowi na końcówce kleszczyków.



DO.290.120
Falcon
120 mm
Straight / Proste



DO.291.120
Falcon
120mm
Curved / Zagięte



DO.294.140
Falcon
140mm

Elastic ligature placing forceps with groove

Kleszczyki z rowkowanymi końcówkami do nakładania ligatur elastycznych

Excellent for placing elastic ligatures, grooved tip provides non-slip grip of any type of elastomeric

Doskonałe narzędzie do nakładania ligatur elastycznych, elastomery "nie wyslizgują się" dzięki rowkowanemu końcówkom kleszczyków.



DO.292.120
Falcon
120 mm



DO.295.140
Falcon
140mm

Elastomeric ligature removing tweezers

Penseta do usuwania ligatur elastycznych

For easy removal of elastomeric ligatures

Zapewnia łatwe usunięcie ligatur elastycznych



DO.285.010

Separators placing pliers

Kleszce do zakładania separatorów

For easy placement of radiopaque and non-radiopaque separators

Zapewniają łatwe umieszczenie separatorów widocznych i niewidocznych na zdjęciach RTG

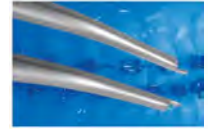

DO.270.155
155mm



DO.270.160
160mm



DO.271.165
165mm



DO.272.165
165mm



Ligature tying pliers
Kleszcze do napinania ligatur



DO.385.160
Coon

Most popular pliers for tying stainless steel ligatures. Unique cam design incorporates a precision-chamfered slot which automatically locks wire ends as tips spread

Najpopularniejsze kleszcze do wiązania ligatur metalowych. Niepowtarzalny projekt krzywki z unikalnym nacięciem pozwala na automatyczne zawiązanie ligatury przy rozwarciu końcówek.



DO.388.160
Steiner

Dished tying cam for easy wrapping and V-notch for easy winding, cam extends away from the body for ease of winding and locking wire. Dished cam can be reversed for left-handed operators

Wklęsły profil krzywki zapewnia szybkie nawinięcie ligatury, a nacięcie w kształcie litery V pozwala na jej łatwe zwinięcie. Odległość krzywki od narzędzia ułatwia zawiązywanie drutu. Dla osób leworęcznych możliwe jest przełożenie krzywki na drugą stronę

Ligature pliers
Kleszyczki do ligatur

Falcon offers wide variety of pliers for ligatures wires with or without tungsten carbide inserts. Falcon and Smaha pattern pliers have finer tips than standard Mathieu patterns, these are also suitable for placing elastic ligatures

Falcon oferuje szeroki wybór kleszyczków do ligatur z wkładką z węgla spiekanego lub bez niej. Kleszyczki Falcon i Smaha mają cieńsze końce niż standardowe kleszyczki Mathieu, są także odpowiednie do zakładania ligatur elastycznych.

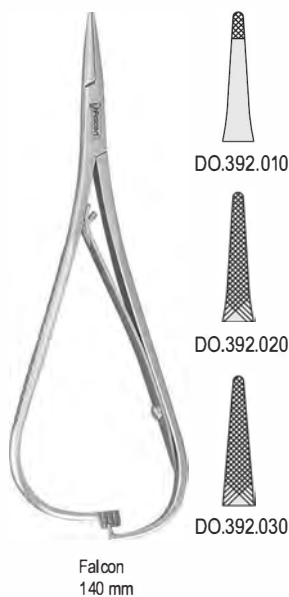

Falcon
140 mm

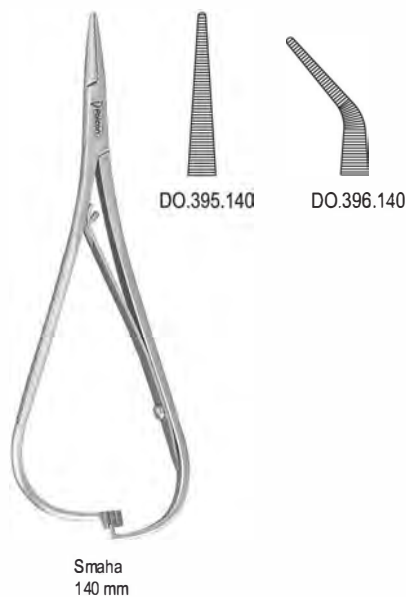

Smaha
140 mm

Falcon with tungsten carbide inserts
z wkładką z węgla spiekanego



DO.393.030
Falcon
140 mm



Instruments for "Fixed Appliance Technique" Narzędzia do techniki aparatów stałych

Distal end bending instruments Instrumenty do zaginania końcówek dystalnych

Very useful instrument for bending archwire distal ends to the buccal tube to create an easy cinch back bend in an area which is usually very hard to reach. Simply insert instrument to distal end of wire extracting through buccal tube and twist forward. Also can be used to bend tails of springs.

Niezawodny instrument do zaginania końcówek dystalnych w kierunku rurek policzkowych w miejscach trudnodostępnych. Koniec drutu wystającego z rurki policzkowej należy wsunąć w instrument i zagiąć do przodu. Narzędziem tym można również zaginać końcówki sprężynek.



DO.240.010
For wire upto .022" (0.56 mm)
Do drutu max ø .022" (0.56mm)

DO.240.020
For wire upto .030" (0.76 mm)
Do drutu max ø .030" (0.76mm)



DO.241.010
For wire upto .022" (0.56 mm)
Do drutu max ø .022" (0.56mm)

DO.241.020
For wire upto .030" (0.76 mm)
Do drutu max ø .030" (0.76mm)

Lingual torquing key Instrument do pozycjonowania łuku na powierzchni językowej

DO.400.014



Tweezers for lingual appliances Penseta do zakładania akcesoriów językowych

DO.401.135
135mm



NiTi ice instrument Instrument do aktywacji łuków NiTi

DO.245.010
Turns NiTi wire soft and flexible immediately for faster wire placement
Zmienia łuki Niklowo-Tytanowe, które stają się bardziej miękkie i elastyczne



Turrets for arch forming Trzpienie do formowania łuków

For wires / Do łuków
.016" - .022" (0.41mm - 0.56 mm)



Autoclavable
Możliwość sterylizacji w autoklawie



Torque / Tork
5°, 7° DO.912.010
10°, 13° DO.912.020

DO.911.010
Without torque / Bez torku

DO.910.010
Without torque / Bez torku

Non-autoclavable /
Nie można sterylizować w autoklawie

Instruments for "Fixed Appliance Technique" Narzędzia do techniki aparatów stałych



Distal end cutters with safety hold Kleszce dystalne do cięcia i trzymania drutu

Falcon distal end cutters produce cleaner and closer cut than any other distal end cutter available in market.
All Falcon cutters are fitted with German made, un-breakable, corrosion resistant and durable tungsten carbide inserts.

Kleszce Falcon tną drut precyzyjniej i bliżej niż inne tego typu kleszce dostępne na rynku.
Wszystkie kleszce do cięcia Falcon posiadają końcówki odporne na uszkodzenia mechaniczne i korozję oraz są wzmacniane węglikiem spiekany.



Distal end cutter with safety hold mini head, long handles Kleszce dystalne do cięcia i trzymania drutu, główka mini z długim uchwytem



DO.542.200
Falcon-Mini

- Max. 0.30 mm to 0.50 mm (.012" to .020")
- Max. 0.46 mm x 0.64 mm (.018" x .025")
- ⊗ Max. 0.38 mm to 0.53 mm (.0155" to .0215")
- ⊗ Max. 0.53 mm x 0.64 mm (.021" x .025")

Distal end cutter with safety hold, micro head Kleszce dystalne do cięcia i trzymania drutu, główka mikro



DO.537.200
Falcon Micro

- Max. 0.30 mm to 0.50 mm (.012" to .020")
- Max. 0.46 mm x 0.64 mm (.018" x .025")
- ⊗ Max. 0.38 mm to 0.53 mm (.0155" to .0215")
- ⊗ Max. 0.53 mm x 0.64 mm (.021" x .025")

Distal end cutter with safety hold, long handle Kleszce dystalne do cięcia i trzymania drutu z długim uchwytem



TASK

Made in Japan



30-550SLS
147mm

- Max. 0.30 mm to 0.50 mm (.012" to .020")
- Max. 0.46 mm x 0.64 mm (.018" x .025")
- ⊗ Max. 0.38 mm to 0.53 mm (.0155" to .0215")
- ⊗ Max. 0.53 mm x 0.64 mm (.021" x .025")

Distal end cutter with safety hold, mini head Kleszce dystalne do cięcia i trzymania drutu, główka mini



DO.536.200
Falcon Mini

- Max. 0.30 mm to 0.50 mm (.012" to .020")
- Max. 0.46 mm x 0.64 mm (.018" x .025")
- ⊗ Max. 0.38 mm to 0.53 mm (.0155" to .0215")
- ⊗ Max. 0.53 mm x 0.64 mm (.021" x .025")



Instruments for "Fixed Appliance Technique" Narzędzia do techniki aparatów stałych

Distal end cutter with safety hold, standard
Kleszce dystalne do cięcia i trzymania drutu, standardowe



DO.535.700
Falcon-Standard

- Max. 0.30 mm to 0.50 mm (.012" to .020")
- Max. 0.56 mm x 0.71 mm (.022" x .028")

Distal end cutter with safety hold, mini head
Kleszce dystalne do cięcia i trzymania drutu, główka mini



DO.536.700
Falcon-Mini

- Max. 0.30 mm to 0.50 mm (.012" to .020")
- Max. 0.46 mm x 0.64 mm (.018" x .025")
- ⊗ Max. 0.38 mm to 0.53 mm (.0155" to .0215")
- ⊗ Max. 0.53 mm x 0.64 mm (.021" x .025")

Distal end cutter with safety hold long handles, mini head
Kleszce dystalne do cięcia i trzymania drutu z długim
uchwytem, główka mini



DO.542.700
Falcon-Mini

- Max. 0.30 mm to 0.50 mm (.012" to .020")
- Max. 0.46 mm x 0.64 mm (.018" x .025")
- ⊗ Max. 0.38 mm to 0.53 mm (.0155" to .0215")
- ⊗ Max. 0.53 mm x 0.64 mm (.021" x .025")

Flush-cut Distal end cutter with safety hold
Kleszce dystalne do cięcia i trzymania drutu



DO.545.700
Falcon

- 0.30 mm to 0.50 mm (.012" to .020")
- Max. 0.46 mm x 0.64 mm (.018" x .025")

Instruments for "Fixed Appliance Technique" Narzędzia do techniki aparatów stałych



All Falcon cutters are fitted with German made, un-breakable, corrosion resistant and durable tungsten carbide inserts.
Wszystkie kleszcze do cięcia Falcon posiadają końcówki odporne na uszkodzenia mechaniczne i korozję oraz są wzmacniane węglikiem spiekany.

Hard wire cutter, straight
Kleszcze do cięcia twardego drutu, proste



DO.550.100
Falcon
● Max. 0.30 mm to 0.50 mm (.012" to .020")
■ Max. 0.56 mm x 0.71 mm (.022" x .028")

Hard wire cutter, straight
Kleszcze do cięcia twardego drutu, proste



DO.555.100
Falcon
● Max. 0.30 mm to 0.50 mm (.012" to .020")
■ Max. 0.56 mm x 0.71 mm (.022" x .028")

Soft wire and ligature cutter, mini
Kleszcze do cięcia ligatur, mini



DO.571.200
Falcon-Mini
∩ .25 mm to .38 mm (.010" to .015")

Soft wire and ligature cutter, standard
Kleszcze do cięcia ligatur, standardowe



DO.574.100
Falcon-Standard
∩ .25 mm to .38 mm (.010" to .015")

Soft wire and ligature cutter, micro
Kleszcze do cięcia ligatur, mikro



DO.565.200
Falcon-Micro
∩ 23 mm to .30 mm (.009" to .012")

Soft wire and ligature cutter, 45° angled
Kleszcze do cięcia ligatur, kątowe 45°



DO.578.100
Falcon
∩ .25 mm to .38 mm (.010" to .015")



Instruments for "Fixed Appliance Technique"
Narzędzia do techniki aparatów stałych

Soft wire and ligature cutter, mini
 Kleszce do cięcia ligatur, mini



DO.571.300
 Falcon-Mini
 ⌋ .25 mm to .38 mm (.010" to .015")

Soft wire and ligature cutter, mini
 Kleszce do cięcia ligatur, mini



DO.565.300
 Falcon-Micro
 ⌋ .23 mm to .30 mm (.009" to .012")

Soft wire and ligature cutter, mini
 Kleszce do cięcia ligatur, mini



TASK
 Made in Japan



60-605S
 Task-Mini
 ⌋ .25 mm to .38 mm (.010" to .015")

Soft wire and ligature cutter, standard
 Kleszce do cięcia ligatur, standardowe



TASK
 Made in Japan



30-604WK
 Task-Standard
 ⌋ .23 mm to .30 mm (.009" to .012")

Soft wire and ligature cutter, 15° angled
 Kleszce do cięcia ligatur, kątowe 15°



TASK
 Made in Japan



60-607
 Task-Mini
 ⌋ .25 mm to .38 mm (.010" to .015")

Soft wire and ligature cutter, 45° angled
 Kleszce do cięcia ligatur, kątowe 45°



DO.578.700
 Falcon
 ⌋ .25 mm to .38 mm (.010" to .015")

Instruments for "Fixed Appliance Technique" Narzędzia do techniki aparatów stałych



All Falcon cutters are fitted with German made, un-breakable, corrosion resistant and durable tungsten carbide inserts.
Wszystkie kleszcze do cięcia Falcon posiadają końcówki odporne na uszkodzenia mechaniczne i korozję oraz są wzmacniane węglikiem spiekany.

Hard wire cutter, straight

Kleszcze do cięcia twardego drutu, proste



DO.550.700
Falcon

- Max. 0.30 mm to 0.50 mm (.012" to .020")
- Max. 0.56 mm x 0.71 mm (.022" x .028")

Hard wire cutter, 15° angled

Kleszcze do cięcia twardego drutu, kątowe 15°



DO.555.700
Falcon

- Max. 0.30 mm to 0.50 mm (.012" to .020")
- Max. 0.56 mm x 0.71 mm (.022" x .028")

Hard wire cutter, 15° angled

Kleszcze do cięcia twardego drutu, kątowe 15°

Non-autoclavable
Nie można sterylizować w autoklawie



DO.555.400
Falcon

- Max. 0.30 mm to 0.50 mm (.012" to .020")
- Max. 0.56 mm x 0.71 mm (.022" x .028")

Band removers curved, left and right designed by Falcon Kleszcze do zdejmowania pierścieni wygięte, lewe i prawe Zaprojektowane przez firmę Falcon

Falcon

Curved tips provide easy access and grip of band without excess retraction of cheek or lips
Curved tips securely catches edge of band without slippage while pad rests on occlusal surface
Curved and heavy tips easily remove even stubborn bands

Falcon

Wygięte końcówki pozwalają na łatwy dostęp do pierścienia i jego pewny uchwyt bez retrakcji policzków i warg. Końcówka bez podkładki podważa krawędź pierścienia natomiast końcówka z podkładką spoczywa na powierzchni zęba. Zagięte i ciężkie końcówki pozwalają na zdjęcie nawet "uporczywych" pierścieni.



Band removing pliers, left
Kleszcze do zdejmowania pierścieni, lewe



DO.497.300
Falcon



Band removing pliers, right
Kleszcze do zdejmowania pierścieni, prawe



DO.498.300
Falcon



Instruments for "Fixed Appliance Technique" Narzędzia do techniki aparatów stałych

Band removing pliers, long Kleszcze do zdejmowania pierścieni proste

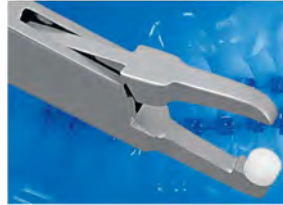

DO.492.300
Falcon

Falcon
Safely and quickly removes posterior bands. Pad rests on occlusal surface and tip catches edge of band.

Falcon
Szybko i pewnie usuwają pierścienie z zębów trzonowych. Specjalna podkładka na jednej z końcówek kleszczy spoczywa na powierzchni zęba podczas gdy druga z końcówek podważa krawędź pierścienia i tym samym zdejmuje go.



DO.495.010
Replacement pads 4.8 mm (1/4"), 2 pieces
Wymienna plastikowa końcówka 4.8mm (1/4") para

DO.495.020
Replacement pads 6.3 mm (3/16"), 2 pieces
Wymienna plastikowa końcówka 6.3mm (3/16") para

Band removing pliers Kleszcze do zdejmowania pierścieni



DO.492.700
Falcon

Band seating pliers Kleszcze do nakładania pierścieni



DO.502.300
Falcon

Contouring pliers Kleszcze konturowe



DO.465.300
Johnson

One convex and one concave tip for contouring and adapting bands or crowns

Wklęsło-wypukłe do konturowania pierścieni lub koron

Contouring pliers for contouring and adapting bands or crowns / Kleszcze do konturowania pierścieni lub koron



DO.475.300
Reynolds

Buccal tube convertible cap removing pliers Kleszcze do otwierania rurek

Cuts off the temporary cap on a convertible first molar buccal tube when banding of second molar is required

Służą do szybkiego i bezpiecznego usuwania zdejmowanych pokrywek otwieranych rurek na pierwsze lub drugie trzonowce



DO.505.010

Spare blade for DO.505.300 (2 pieces)
Wymienne ostże do DO.505.300 (2 szt.)



DO.505.300
Falcon

Instruments for "Fixed Appliance Technique" Narzędzia do techniki aparatów stałych



Bracket removing pliers with plastic tip Kleszcze do zdejmowania zamków z plastikową podkładką



DO.520.300
Falcon

Safely and quickly removes D.B. brackets, soft pad rest on incisal/occlusal surface of tooth for leverage and is comfortable for patient, sharp tip wedge the bracket base, one squeeze easily remove the bracket without extra force

Szybko i bezpiecznie zdejmują zamki, plastikowa podkładka spoczywa na powierzchni zęba podczas gdy druga końcówka kleszczy podważa podstawę zamka. Jedno ściśnięcie łatwo usuwa zamek bez konieczności używania większej siły.

Bracket removing pliers Kleszcze do zdejmowania zamków



DO.511.300
Falcon

Bracket removing pliers straight
Kleszcze do zdejmowania zamków proste

Bracket removing pliers Kleszcze do zdejmowania zamków



DO.511.700
Falcon

Bracket removing pliers straight
Kleszcze do zdejmowania zamków proste

Bracket removing pliers Kleszcze do zdejmowania zamków



DO.510.300
Falcon

Tips wedge between both edges of the bracket base and tooth surface to remove bracket easily.

Końcówki kleszczy opierają się na krawędziach zamka, co pozwala na jego szybkie usunięcie.

The 60° angled tip allows easy access to posterior brackets

Końcówka wygięta pod kątem 60° pozwala na łatwy dostęp do zamków na przedtrzonowcach

Bracket removing pliers with plastic tip Kleszcze do zdejmowania zamków z plastikową podkładką



DO.520.700
Falcon

Bracket removing pliers Kleszcze do zdejmowania zamków



DO.510.700
Falcon

The 60° angled tip allows easy access to posterior brackets

Końcówka wygięta pod kątem 60° pozwala na łatwy dostęp do zamków na przedtrzonowcach



Instruments for "Fixed Appliance Technique" Narzędzia do techniki aparatów stałych



DO.585.300
Aderer
3-jaw wire bending pliers.
Precision aligned and contoured tips for consistent bends without damaging the wire

Kleszcze trójszczękowe do doginania drutu
Końcówki kleszczy są precyzyjnie wykończone, aby nie zniszczyć drutu podczas jego doginania.

- 0.36 mm to 0.76 mm (.014" to .030")
- Max. 0.56 mm x 0.71 mm (.022" x .028")



DO.590.300
Angle
Bird beak pliers with cutter.
Universal pliers with all wire bending and loop forming features of bird beak pliers plus cutter

Kleszcze "ptasie dzioby" z możliwością cięcia drutu
Uniwersalne kleszcze do cięcia i doginania drutu oraz formowania pętli

- 0.36 mm to 0.50 mm (.014" to .020")
- Max. 0.41 mm x 0.56 mm (.016" x .022")

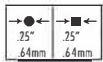

DO.592.300
Angle
Bird beak pliers
The most popular and versatile pliers for wire bending and loop forming, the tips are extremely fine for making small loops

Najpopularniejsze kleszcze do doginania drutu i formowania pętli. Wąskie końcówki kleszczy umożliwiają wykonanie małych pętli.

- 0.36 mm to 0.71 mm (.014" to .028")
- Max. 0.56 mm x 0.71 mm (.022" x .028")

Rectangular arch forming and torquing pliers (Ribbon arch pliers) Kleszcze do formowania i torkowania łuków

Used to form offset and 90° bends on round or rectangular wire. Radiuses on tips edges do not score wire during torquing. Available in three different tip widths, tips are parallel at 0.5 mm opening.

Przeznaczone do łuków okrągłych i prostokątnych. Stosowane do wykonywania dogięć pod kątem prostym jak również do nadawania łukom torku. Profil końcówek nie uszkadza łuków. Kleszcze dostępne z trzema szerokościami końcówek, które są ustawione równolegle.



DO.615.300
Falcon-Slim
Rectangular arch forming and torquing pliers, 0.64mm (.025") wide tips

Kleszcze do formowania łuków prostokątnych i nadawania torku, szerokość końcówek 0.64mm (.025")

- Max. 0.30 mm to 0.50 mm (.012" to .020")
- Max. 0.41 mm x 0.56 mm (.016" x .022")



DO.616.300
Falcon / Angle
Rectangular arch forming and torquing pliers, 1.27mm (.050") wide tips

Kleszcze do formowania łuków prostokątnych i nadawania torku, szerokość końcówek 1.27mm (.050")

- Max. 0.30 mm to 0.56 mm (.012" to .022")
- Max. 0.53 mm x 0.64 mm (.021" x .025")



DO.713.300
Tweed / Angle
Rectangular arch forming and torquing pliers, 1.78mm (.070") wide tips

Kleszcze do formowania łuków prostokątnych i nadawania torku, szerokość końcówek 1.78mm (.070")

- Max. 0.30 mm to 0.71 mm (.012" to .028")
- Max. 0.56 mm x 0.71 mm (.022" x .028")

Instruments for "Fixed Appliance Technique" Narzędzia do techniki aparatów stałych



Lingual / Palatal arch forming pliers Kleszcze do formowania łuków językowych i podniebiennych



DO.618.300
Falcon
● 0.76 mm (.030") / 0.91 mm (.036")

Surgical ball hook crimping pliers Kleszcze do zaciskania haczyków



Used to crimp surgical ball hooks to archwire, slotted tip fits over the base of hook for secure hold while crimping, also can be used to crimp stops and posts. Long handles for easy access to posterior region
Zaprojektowane aby w prosty sposób utrzymać haczyk oraz umieścić go na łuku. Dzięki jednemu ściśnięciu haczyk znajdzie się na łuku. Długie uchwyty ułatwiają dotarcie do miejsc trudnodostępnych.



DO.621.300
Falcon
Straight / Proste

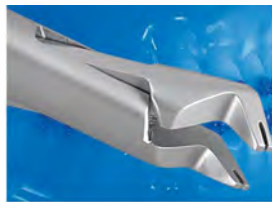

DO.620.300
Falcon
Angled / Kątowe



DO.610.300
Falcon
Light wire bending and loop forming pliers
Kleszcze do zaginania drutu i formowania pętli
● 0.36 mm to 0.50 mm (.012" to .020")
■ Max. 0.41 mm x 0.56 mm (.016" x .022")

Distal end bending pliers (Cinch Back/Tie Back) Kleszcze do zaginania końcówek dystalnych



Designed to bend distal end of wire extracting through buccal tube away from cheek. Angled tips and long handles allow easy access to posterior region
Zaprojektowane do bezpiecznego zaginania końcówek dystalnych. Kątowe końcówki i długi uchwyt ułatwiają dotarcie do miejsc trudnodostępnych.



DO.623.300
Falcon
● Max. 0.30 mm to 0.50 mm (.012" to .020")
■ Max. 0.56 mm x 0.71 mm (.022" x .028")

Adhesive removing pliers Kleszcze do usuwania kleju



DO.525.700
Falcon
DO.525.010 Replacement metal tip
Wymienna metalowa końcówka



Instruments for "Fixed Appliance Technique" Narzędzia do techniki aparatów stałych



Multipurpose pliers, useful for placement and removal of archwires and auxiliaries. Tips are serrated to securely hold wire, the jaws are bowed and contact only at tips to prevent lip pinching, box joint design for stability.

Kleszce wielofunkcyjne mają zastosowanie przy zakładaniu zamków, luków, itp. Żłobione końcówki pewnie utrzymują drut bez jego uszkodzenia. Niestykające się końcówki kleszczy zapewniają bezpieczeństwo warg. Konstrukcja z zawiasami pudełkowymi zapewnia trwałość

FALCON with tungsten carbide inserts
GRIP z końcówką z węgla spiekanego



How Standard
4mm wide tips
kończówki o szerokości 4 mm



DO.661.100
Straight / Proste
● 0.30 mm to 0.50 mm (.012" to .020")
■ Max. 0.56 mm x 0.71 mm (.022" x .028")



DO.662.100
Angled / Kątowe
● 0.30 mm to 0.50 mm (.012" to .020")
■ Max. 0.56 mm x 0.71 mm (.022" x .028")



How Standard
4mm wide tips
kończówki o szerokości 4 mm



DO.661.300
Straight / Proste
● 0.30 mm to 0.50 mm (.012" to .020")
■ Max. 0.56 mm x 0.71 mm (.022" x .028")



DO.662.300
Angled / Kątowe
● 0.30 mm to 0.50 mm (.012" to .020")
■ Max. 0.56 mm x 0.71 mm (.022" x .028")



How Mini
2.4 mm wide tips
kończówki o szerokości 2.4 mm



DO.664.300
Straight / Proste
● 0.30 mm to 0.50 mm (.012" to .020")
■ Max. 0.56 mm x 0.71 mm (.022" x .028")



DO.665.300
Angled / Kątowe
● 0.30 mm to 0.50 mm (.012" to .020")
■ Max. 0.56 mm x 0.71 mm (.022" x .028")



How Mini
2.4 mm wide tips
kończówki o szerokości 2.4 mm



DO.664.700
Straight / Proste
● 0.30 mm to 0.50 mm (.012" to .020")
■ Max. 0.56 mm x 0.71 mm (.022" x .028")



DO.665.700
Angled / Kątowe
● 0.30 mm to 0.50 mm (.012" to .020")
■ Max. 0.56 mm x 0.71 mm (.022" x .028")



DO.675.300
Jarabak
Light wire bending pliers
Serrated tips and grooves assure accurate bending and closing of loops
Kleszce do doginania drutu
Żłobione końcówki z rowkami dokładnie doginają drut i zamykają pętle.
● 0.30 mm to 0.50 mm (.012" to .020")
■ Max. 0.46 mm x 0.56 mm (.018" x .022")



DO.688.300
Nance
Loop forming pliers
Four steps beak for making precision loops of 3, 4, 5 or 6 mm in round or rectangular wires. One tip is serrated to prevent wire slippage
Kleszce do formowania pętli
Czterostopniowe dzioby dokładnie formują pętle 3, 4, 5 i 6 mm na lukach okrągłych lub prostokątnych. Jedna końcówka jest żłobiona aby zapobiec wyślizgiwaniu się luku.
● 0.36 mm to 0.71 mm (.014" to .028")
■ Max. 0.56 mm x 0.71 mm (.022" x .028")

Instruments for "Fixed Appliance Technique"

Narzędzia do techniki aparatów stałych



Arch forming and contouring pliers Kleszce do formowania i konturowania łuków



DO.602.300
De La Rosa
Arch forming and contouring pliers, without grooves. Matching concave and convex jaws for contouring and forming archwires without scoring or torquing
Kleszce do formowania i konturowania łuków, bez rowków, o końcówkach wklęsło-wypukłych, co pozwala na formowanie i konturowanie łuków bez torkowania

- 0.36 mm to 0.50 mm (.012" to .020")
- Max. 0.53 mm x 0.64 mm (.021" x .025")

Loop forming pliers Kleszce do formowania pętli



DO.705.300
Tweed
● 0.30 mm to 0.50 mm (.012" to .020")
■ Max. 0.46 mm x 0.56 mm (.018" x .022")

Utility pliers Kleszce wielofunkcyjne



Multipurpose pliers, useful for placement and removal of archwires and auxiliaries. Tips are serrated to securely hold wire and tapered thus fits between brackets. The jaws are bowed and contact only at tips to prevent lip pinching. Box joint design for stability.

Kleszce wielofunkcyjne mają zastosowanie przy zakładaniu zamków, łuków, itp. Żłobione końcówki pewnie utrzymują drut bez jego uszkodzenia. Niestykające się końcówki kleszczy zapewniają bezpieczeństwo warg. Konstrukcja z zawiasami pudełkowymi zapewnia trwałość.



FALCON with tungsten carbide inserts
GRIP z końcówką z węgla spiekane



DO.735.100
Weingart Mini
Slim design for better accessibility in posterior and lingual areas

Smukła konstrukcja umożliwia dotarcie w trudnodostępne miejsca np. zębów trzonowych.

- Max. 0.30 mm to 0.50 mm (.012" to .020")
- Max. 0.56 mm x 0.71 mm (.022" x .028")



FALCON with tungsten carbide inserts
GRIP z końcówką z węgla spiekane



DO.738.100
Weingart

- Max. 0.30 mm to 0.50 mm (.012" to .020")
- Max. 0.56 mm x 0.71 mm (.022" x .028")



DO.735.300
Weingart Mini
Slim design for better accessibility in posterior and lingual areas

Smukła konstrukcja umożliwia dotarcie w trudnodostępne miejsca np. zębów trzonowych.

- Max. 0.30 mm to 0.50 mm (.012" to .020")
- Max. 0.56 mm x 0.71 mm (.022" x .028")



DO.736.300
Weingart Narrow
Narrow long lips for better access to hard to reach areas

Wąskie i długie końcówki kleszczy ułatwiają dotarcie do trudnodostępnych miejsc.

- Max. 0.30 mm to 0.50 mm (.012" to .020")
- Max. 0.56 mm x 0.71 mm (.022" x .028")



Instruments for "Fixed Appliance Technique" Narzędzia do techniki aparatów stałych

Utility pliers Kleszcze wielofunkcyjne



Multipurpose pliers, useful for placement and removal of archwires and auxiliaries. Tips are serrated to securely hold wire and tapered thus fits between brackets. The jaws are bowed and contact only at tips to prevent lip pinching. Box joint design for stability.

Kleszcze wielofunkcyjne mają zastosowanie przy zakładaniu zamków, luków, itp. Żłobione końcówki pewnie utrzymują drut bez jego uszkodzenia. Niestykające się końcówki kleszczy zapewniają bezpieczeństwo warg. Konstrukcja z zawiasami pudełkowymi zapewnia trwałość.



DO.738.300
Weingart
● Max. 0.30 mm to 0.50 mm (.012" to .020")
■ Max. 0.56 mm x 0.71 mm (.022" x .028")



Slim-line Pliers



DO.738.500
Weingart
Slim and sleek design with long handles for better access to the posterior area, also suitable for lingual technique.

Kleszcze posiadają wyprofilowane wąskie końcówki oraz długi uchwyt, aby ułatwić dotarcie do trudnodostępnych miejsc.

● Max. 0.30 mm to 0.50 mm (.012" to .020")
■ Max. 0.56 mm x 0.71 mm (.022" x .028")



DO.735.700
Weingart-Slim
● Max. 0.30 mm to 0.50 mm (.012" to .020")
■ Max. 0.56 mm x 0.71 mm (.022" x .028")



DO.738.700
Weingart
● Max. 0.30 mm to 0.50 mm (.012" to .020")
■ Max. 0.56 mm x 0.71 mm (.022" x .028")

Loop forming pliers Kleszcze do formowania pętli



DO.712.300
Tweed
Loop forming pliers
Kleszcze do formowania pętli



DO.700.200
Omega
Loop forming pliers with replaceable 440 stainless steel tip, three step tip has 1.14, 1.52 and 1.91 mm diameters
Kleszcze do formowania pętli z wymienną, trójstopniową końcówką (1.14, 1.52, 1.91 mm) ze stali nierdzewnej 440
● Max. 0.36 mm to 0.64 mm (.014" to .025")
■ Max. 0.53 mm x 0.64 mm (.021" x .025")



Loop forming pliers
Kleszce do formowania pętli



DO.710.200
Tweed
Loop forming pliers with replaceable 440 stainless steel tip, three step tip has 1.14, 1.52 and 1.91mm diameters
Kleszce do formowania pętli z wymienną, trójstopniową końcówką (1.14 mm, 1.52 mm, 1.91 mm) ze stali nierdzewnej 440

- Max. 0.36 mm to 0.64 mm (.014" to .025")
- Max. 0.53 mm x 0.64 mm (.021" x .025")



DO.700.010
Replacement tip stainless steel 440 for Omega or Tweed loop forming pliers.
Tip diameters 1.14mm, 1.52 and 1.91 mm
Wymienna trójstopniowa końcówka (1.14 mm, 1.52 mm, 1.91 mm) ze stali nierdzewnej 440 pasująca do kleszczy Omega lub Tweed

Wire bending and loop forming pliers
Kleszce do doginania drutu i formowania pętli



DO.592.700
Angle (Bird beak)
● 0.30 mm to 0.50 mm (.012" to .020")
■ Max. 0.56 mm x 0.71 mm (.022" x .028")

Light wire bending and loop forming pliers
Kleszce do doginania drutu i formowania pętli



DO.610.700
Falcon
● 0.30 mm to 0.50 mm (.012" to .020")
■ Max. 0.41 mm x 0.56 mm (.016" x .022")

Light wire bending pliers with cutter
Kleszce do doginania i cięcia drutu



with tungsten carbide inserts
z końcówką z węgla spiekane



DO.608.700
Falcon
● 0.30 mm to 0.50 mm (.012" to .020")
■ Max. 0.46 mm x 0.56 mm (.018" x .022")

Light wire bending and loop forming pliers with cutter
Kleszce do doginania i cięcia drutu oraz formowania pętli



DO.609.700
Falcon
● 0.30 mm to 0.50 mm (.012" to .020")
■ Max. 0.46 mm x 0.56 mm (.018" x .022")



Instruments for "Fixed Appliance Technique"
Narzędzia do techniki aparatów stałych

Light wire bending and loop forming pliers, grooved tip
Kleszce do doginania drutu i formowania pętli z wyłobioną końcówką



DO.705.700
 Tweed
 ● 0.30 mm to 0.50 mm (.012" to .020")
 ■ Max. 0.46 mm x 0.56 mm (.018" x .022")

Loop forming pliers with cutter
Kleszce do cięcia i formowania pętli



DO.711.700
 Tweed
 ● 0.30 mm to 0.50 mm (.012" to .020")
 ■ Max. 0.53 mm x 0.64 mm (.021" x .025")

Archwire forming pliers, concave and convex tips
Kleszce do formowania łuków z wklęsło-wypukłymi końcówkami



DO.613.700
 Hollow-Chop
 ● 0.30 mm to 0.71 mm (.012" to .028")
 ■ Max. 0.56 mm x 0.71 mm (.022" x .028")

Multi-purpose pliers, bird beak, De la Rosa and cutter in one
Kleszce wielofunkcyjne (De la Rosa i do cięcia drutu), "ptasie dzioby"



DO.598.700
 Falcon
 ● 0.30 mm to 0.50 mm (.012" to .020")
 ■ Max. 0.46 mm x 0.56 mm (.018" x .022")

Light wire bending pliers
Kleszce do doginania drutu



DO.675.700
 Jarabak
 ● 0.30 mm to 0.50 mm (.012" to .020")
 ■ Max. 0.46 mm x 0.56 mm (.018" x .022")

3-jaw wire bending pliers
Kleszce trójszczękowe do doginania drutu



DO.585.700
 Aderer
 ● 0.30 mm to 0.50 mm (.012" to .020")
 ■ Max. 0.56 mm x 0.71 mm (.022" x .028")



Distal end bending pliers
Kleszce do zaginania końcówek dystalnych



DO.623.700
Falcon (Cinch back / tie back)
● 0.30 mm to 0.50 mm (.012" to .020")
■ Max. 0.56 mm x 0.71 mm (.022" x .028")

Ligature forming pliers
Kleszce do formowania ligatur



DO.580.700
Falcon
⌋ 25 mm to 38 mm (.010" to .015")

Distal end bending pliers
Kleszce do zaginania końcówek dystalnych



DO.624.700
Falcon (Hammer head)
● 0.30 mm to 0.50 mm (.012" to .020")
■ Max. 0.56 mm x 0.71 mm (.022" x .028")

Loop forming pliers
Kleszce do formowania pętli



DO.688.700
Nance
● 0.36 mm to 0.71 mm (.014" to .028")
■ Max. 0.56 mm x 0.71 mm (.022" x .028")

Torquing pliers set
Kleszce do torkowania, zestaw



DO.641.700
Falcon
:022 :018

Detailing step pliers / Bayonet bending pliers - 1mm
Kleszce do formowania stopni 1mm



DO.630.700
Falcon
● 0.30 mm to 0.50 mm (.012" to .020")
■ Max. 0.56 mm x 0.71 mm (.022" x .028")



Instruments for "Fixed Appliance Technique"
Narzędzia do techniki aparatów stałych

Rectangular arch forming and torquing pliers
Kleszcze do torkowania i formowania łuków prostokątnych



DO.713.700
 Tweed / Angle
 ● 0.30 mm to 0.71 mm (.012" to .028")
 ■ Max. 0.56 mm x 0.71 mm (.022" x .028")

Stop pliers V-Bend - 1mm
Kleszcze do zagięć V - 1mm



DO.655.700
 Falcon
 ● 0.30 mm to 0.50 mm (.012" to .020")
 ■ Max. 0.43 mm x 0.56 mm (.017" x .022")

Surgical ball hook crimping pliers, angled
Kleszcze do zaciskania haczyków, kątowe



DO.620.700
 Falcon

Lingual / palatal arch forming pliers
Kleszcze do formowania łuków podniebiennych



DO.618.700
 Falcon
 ● 0.76 mm (.030") / 0.91 mm (.036")

Surgical ball hook crimping pliers, straight
Kleszcze do zaciskania haczyków, proste



DO.621.700
 Falcon

Aligner pliers
Kleszcze / Dziurkacz okrągły do aparatów retencyjnych



5mm
 5.5mm

TASK
 Made in Japan



60-731
 Hole punch
 Dziurkacz okrągły
 125mm

Instruments for "Removable Appliance Technique" Narzędzia do techniki aparatów ruchomych

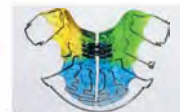

Aligner pliers

Kleszcze / Dziurkacz okrągły do aparatów retencyjnych



TASK
Made in Japan



60-732
Horizontal hole
Dziurkacz poziomy
118mm



TASK
Made in Japan



60-733
Vertical hole
Dziurkacz pionowy
118mm



TASK
Made in Japan



60-734
Tear drop hole
Dziurkacz kształt łzy
118mm

Hard wire cutters

Kleszcze do cięcia twardego drutu



Falcon
CNT with tungsten carbide inserts
z końcówką z węgla spiekane



DO.777.100
● 0.70 mm to 1.00 mm (.028" to .040")

Hard wire cutters

Kleszcze do cięcia twardego drutu



Falcon
CNT with tungsten carbide inserts
z końcówką z węgla spiekane

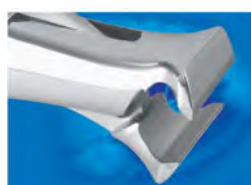

DO.779.100
● 0.70 mm to 1.00 mm (.028" to .040")

Hard wire cutters

Kleszcze do cięcia twardego drutu



DO.777.300
● 0.60 mm to 0.80 mm (.024" to .032")

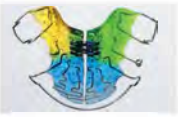

Instruments for "Removable Appliance Technique" Narzędzia do techniki aparatów ruchomych

Hard wire cutters Kleszcze do cięcia twardego drutu



DO.779.300
● 0.60 mm to 0.80 mm (.024" to .032")

Heavy duty hard wire cutters Kleszcze do cięcia twardego drutu



Falcon
Compound action
Cut heavy wires with little force
Tną twarde drut przy użyciu niewielkiej siły



DO.785.300
Small / Male
Stainless steel, autoclavable
Stal nierdzewna, możliwość sterylizacji w autoklawie
● 0.87 mm to 1.1 mm (.028" to .045")

Hard wire cutters Kleszcze do cięcia twardego drutu



Falcon
Compound action
Cut heavy wires with little force
Tną twarde drut przy użyciu niewielkiej siły



DO.786.300
Large / Duże
Stainless steel, autoclavable
Stal nierdzewna, możliwość sterylizacji w autoklawie
● 0.80 mm to 1.50 mm (.032" to .057")

Heavy duty hard wire cutters Kleszcze do cięcia twardego drutu



Falcon
Compound action
Cut heavy wires with little force
Tną twarde drut przy użyciu niewielkiej siły

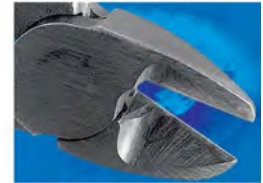

DO.786.400
Large / Duże
Carbon steel, non autoclavable
Stal węglowa, nie można sterylizować w autoklawie
● 0.80 mm to 1.50 mm (.032" to .057")

Hard wire cutters Kleszcze do cięcia twardego drutu



Falcon
Compound action
Cut heavy wires with little force
Tną twarde drut przy użyciu niewielkiej siły



DO.787.300
Small / Male
Stainless steel, autoclavable
Stal nierdzewna, możliwość sterylizacji w autoklawie
● 0.87 mm to 1.1 mm (.028" to .045")

Universal pliers Kleszcze uniwersalne



DO.884.300
Universal Mini - Dolphin style
Wire bending and cutting pliers

Kleszcze kramponowe - delfinki mini
Do cięcia i doginania drutu
● Bends/Doginają : 0.9 mm (.036")
Cuts/Tną : 0.7 mm (.028")

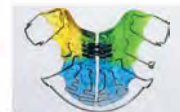

Universal pliers
Kleszcze uniwersalne



DO.885.300
Universal - Dolphin style
Wire bending and cutting pliers

Kleszcze kramponowe - delfinki standard
Do cięcia i doginania drutu
● Bends/Doginają: 0.9 mm (.036")
Cuts/Tną: 0.7 mm (.028")

Universal pliers
Kleszcze uniwersalne



DO.886.300
Universal - Taper style
Wire bending and cutting pliers

Kleszcze kramponowe
Do cięcia i doginania drutu
● Bends/Doginają: 0.9 mm (.036")
Cuts/Tną: 0.7 mm (.028")

Pliers for facebow
Kleszcze do łuków twarzowych



OW.553.180
180mm

Falcon-Cut wire cutter x-action angled
Kleszcze do cięcia drutu z przekładnią boczne

For hard wires up to 2.0 mm Ø, For soft wires up to 3 mm Ø
Tnąt drut twarde do 2,0 mm Ø i miękkie do 3 mm Ø

Universal pliers
Kleszcze uniwersalne



DO.895.300
Waldsachs
Wire bending and cutting pliers

Kleszcze do cięcia i doginania drutu
● Bends/Doginają: 0.9 mm (.036")
Cuts/Tną: 0.7 mm (.028")

Pliers for facebow
Kleszcze do łuków twarzowych



DO.810.300
Aderer
Facebow loop forming pliers
For forming loops in either inner or outer bows of facebow

Kleszcze do formowania łuków twarzowych
Do formowania pętli zewnętrznych i wewnętrznych na łuku
Max. 1.60 mm (.063")

Pliers for facebow
Kleszcze do łuków twarzowych



DO.892.300
Magnum
Universal facebow loop forming and cutting pliers
Heavy duty pliers easily bends or cuts outer or inner bow of a facebow

Kleszcze do formowania i cięcia łuków twarzowych
Max. 1.80 mm (.071")

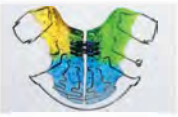

Instruments for "Removable Appliance Technique" Narzędzia do techniki aparatów ruchomych

Pliers for facebow Kleszcze do łuków twarzowych



DO.888.300
Universal
Parallel jaw pliers with side cutter, compound action
Powerful pliers easily cuts outer bow of a facebow, serrated jaws assure non-slip grip while bending

Kleszcze do formowania i cięcia łuków twarzowych
Ząbkowane końcówki zapewniają pewny uchwyt łuku podczas formowania.

Max. 1.80 mm (.071")

Wire bending pliers Kleszcze do doginania drutu



Adams pliers with tungsten carbide tips
Kleszcze Adams z wkładką z węgla spiekane



DO.796.100
Adams Maxi Fig. 64

● 0.36 mm to 0.81 mm (.014" to .032")
■ Max. 0.56 mm x 0.71 mm (.022" x .028")

Tips of all Adams pliers parallel at 1mm opening box joint, available in mini and maxi sizes
Konstrukcja z zawiasami pudełkowymi, dostępne w dwóch rozmiarach: mini i maxi

Wire bending pliers Kleszcze do doginania drutu



Adams pliers with tungsten carbide tips
Kleszcze Adams z wkładką z węgla spiekane



DO.799.100
Adams Maxi Fig. 65

● 0.36 mm to 0.81 mm (.014" to .032")
■ Max. 0.56 mm x 0.71 mm (.022" x .028")

Tips of all Adams pliers parallel at 1mm opening box joint, available in mini and maxi sizes
Konstrukcja z zawiasami pudełkowymi, dostępne w dwóch rozmiarach: mini i maxi

Wire bending pliers Kleszcze do doginania drutu

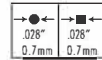

DO.795.300
Adams Mini

● 0.36 mm to 0.81 mm (.014" to .032")
■ Max. 0.56 mm x 0.71 mm (.022" x .028")

Tips of all Adams pliers parallel at 1mm opening box joint, available in mini and maxi sizes
Konstrukcja z zawiasami pudełkowymi, dostępne w dwóch rozmiarach: mini i maxi

Wire bending pliers Kleszcze do doginania drutu



DO.798.300
Adams Mini

● 0.36 mm to 0.81 mm (.014" to .032")
■ Max. 0.56 mm x 0.71 mm (.022" x .028")

Tips of all Adams pliers parallel at 1mm opening box joint, available in mini and maxi sizes
Konstrukcja z zawiasami pudełkowymi, dostępne w dwóch rozmiarach: mini i maxi

Wire bending pliers Kleszcze do doginania drutu

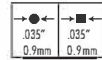

DO.796.300
Adams Maxi Fig. 64

● 0.36 mm to 0.81 mm (.014" to .032")
■ Max. 0.56 mm x 0.71 mm (.022" x .028")

Tips of all Adams pliers parallel at 1mm opening box joint, available in mini and maxi sizes
Konstrukcja z zawiasami pudełkowymi, dostępne w dwóch rozmiarach: mini i maxi

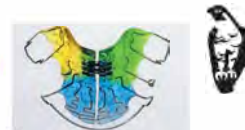

Wire bending pliers
Kleszcze do doginania drutu

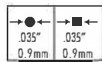

DO.799.300
Adams Maxi Fig. 65
● 0.36 mm to 0.81 mm (.014" to .032")
■ Max. 0.56 mm x 0.71 mm (.022" x .028")

Tips of all Adams pliers parallel at 1mm opening
box joint, available in mini and maxi sizes
Konstrukcja z zawiasami pudełkowymi, dostępne
w dwóch rozmiarach: mini i maxi

Wire bending pliers
Kleszcze do doginania drutu

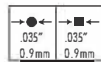

DO.812.300
Angle
Bird beak lab. pliers
Tips parallel at 1mm opening

Kleszcze proteotypyczne "placie dzioby"
Równoległe końcówki przy 1 mm rozwarciu
● 0.36 mm to 0.81 mm (.014" to .032")
■ Max. 0.56 mm x 0.71 mm (.022" x .028")

Wire bending pliers
Kleszcze do doginania drutu

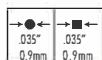

DO.813.300
Angle
Round nose wire bending and
loop forming pliers

Kleszcze do doginania drutu i formowania pętli, okrągłe
kończówki

● 0.36 mm to 0.81 mm (.014" to .032")
■ Max. 0.56 mm x 0.71 mm (.022" x .028")

3-Jaw wire bending pliers
Kleszcze trójszczękowe do doginania drutu

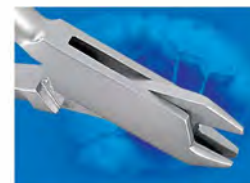

DO.806.300
Aderer - Mini

Precision aligned and contoured tips for consistent
bends without damaging wire.
Kończówki kleszczy są precyzyjnie wykończone, aby
nie zniszczyć drutu podczas jego doginania.

● 0.36 mm to 0.50 mm (.014" to .020")
■ Max. 0.53 mm x 0.64 mm (.021" x .025")

3-Jaw wire bending pliers
Kleszcze trójszczękowe do doginania drutu



DO.807.300
Aderer - Midi

Precision aligned and contoured tips for consistent
bends without damaging wire.
Kończówki kleszczy są precyzyjnie wykończone, aby
nie zniszczyć drutu podczas jego doginania.

● 0.36 mm to 0.71 mm (.014" to .028")
■ Max. 0.56 mm x 0.71 mm (.022" x .028")

3-Jaw wire bending pliers
Kleszcze trójszczękowe do doginania drutu



DO.808.300
Aderer - Maxi

Precision aligned and contoured tips for consistent
bends without damaging wire.
Kończówki kleszczy są precyzyjnie wykończone, aby
nie zniszczyć drutu podczas jego doginania.

● 0.50 mm to 0.91 mm (.020" to .036")
■ Max. 0.56 mm x 0.71 mm (.022" x .028")

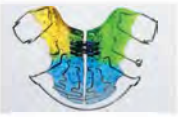

Instruments for "Removable Appliance Technique" Narzędzia do techniki aparatów ruchomych

Loop forming pliers
Kleszcze do formowania pętli



DO.870.300
Schwarz Mini
● Max. 0.50 mm (.020")
Optical style, round and concave beaks.
Końcówki kleszczy wklęsło-wypukłe.

Loop forming pliers
Kleszcze do formowania pętli



DO.871.300
Schwarz Midi
● Max. 0.70 mm (.028")
Optical style, round and concave beaks.
Końcówki kleszczy wklęsło-wypukłe.

Loop forming pliers
Kleszcze do formowania pętli



DO.872.300
Schwarz Maxi
● Max. 0.70 mm (.028")
Optical style, round and concave beaks.
Końcówki kleszczy wklęsło-wypukłe.

Loop forming pliers
Kleszcze do formowania pętli



DO.874.300
Schwarz graduated / kalibrowane
● Max. 0.70 mm (.028")
Optical style, round and concave beaks.
Końcówki kleszczy wklęsło-wypukłe.

Loop forming pliers
Kleszcze do formowania pętli



DO.850.300
Mckellops
Optical style, round and concave beaks.
Heavy loop forming pliers
Kleszcze wklęsło-wypukłe do formowania pętli
● Max. 0.80 mm (.032")

Flat nose wire bending pliers
Kleszcze płaskie do doginania drutu

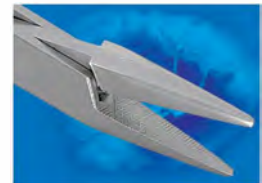

DO.830.300
Falcon
Flat nose wire bending pliers
Kleszcze płaskie do doginania drutu
● 0.36 mm to 0.71 mm (.014" to .028")
■ Max. 0.56 mm x 0.71 mm (.022" x .028")

Instruments for "Removable Appliance Technique"

Narzędzia do techniki aparatów ruchomych

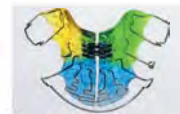

Wire bending and loop forming pliers
Kleszcze do doginania i formowania pętli



DO.835.300
Falcon
Round nose wire bending and loop forming pliers
Kleszcze okrągło-okrągłe do doginania i formowania pętli
● 0.36 mm to 0.71 mm (.014" to .028")
■ Max. 0.56 mm x 0.71 mm (.022" x .028")

Wire bending pliers
Kleszcze do doginania drutu

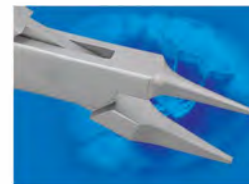

DO.860.300
Peeso
Round nose wire bending pliers
Kleszcze płasko-okrągłe do doginania drutu
● 0.36 mm to 0.71 mm (.014" to .028")
■ Max. 0.56 mm x 0.71 mm (.022" x .028")

Crown and collar contouring pliers
Kleszcze do konturowania koron i pierścieni

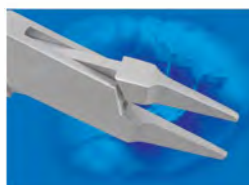

DO.861.300
Peeso
Crown and collar contouring pliers
Kleszcze płasko-płaskie do konturowania koron i pierścieni

Loop forming pliers
Kleszcze do formowania pętli



DO.896.300
Young
Loop forming pliers
Kleszcze do formowania pętli
● 0.36 mm to 0.71 mm (.014" to .028")
■ Max. 0.56 mm x 0.71 mm (.022" x .028")

Arrow clasp bending pliers
Kleszcze do przeginania klamer grotowych

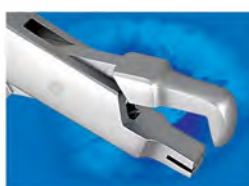

Max. 0.70 mm (.028")
DO.876.300
Schwarz
Arrow clasp bending pliers
Kleszcze do przeginania klamer grotowych

Arrow clasp forming pliers
Kleszcze do formowania klamer grotowych



- 1
- 2
- 3
- 4
- 5

Max. 0.70 mm (.028")
DO.877.300
Schwarz
Arrow clasp forming pliers
Kleszcze do formowania klamer grotowych

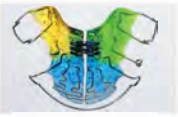

Instruments for "Removable Appliance Technique" Narzędzia do techniki aparatów ruchomych

Clasp forming pliers
Kleszce do formowania klamer

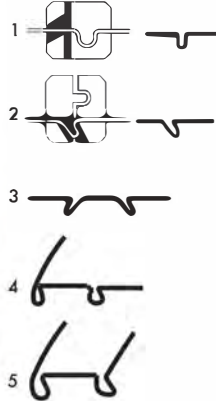

Max. 0.70 mm (.028")

DO.845.100
Nance
Adams clasp forming pliers
Kleszce do formowania klamer typu Adams

Pliers stand / Stojak na kleszce



DO.964.010

Upright pliers stands / Stojaki na kleszce



DO.965.010 Black / Czarny



DO.965.040 Clear / Przezroczysty



DO.965.080 White / Biały



DO.965.020 Blue / Niebieski

Instruments organizer / Stojak na instrumenty



DO.966.030



DO.966.020

Pliers stands, autoclavable
Stojaki na kleszcze, możliwość sterylizacji w autoklawie

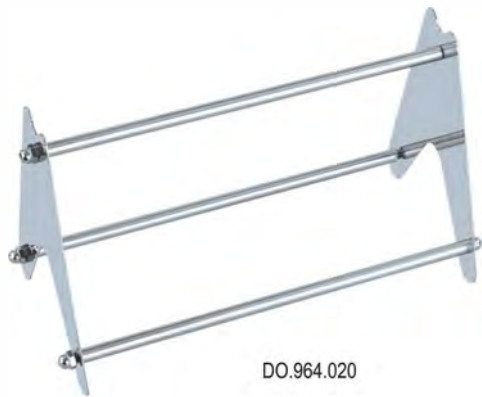

DO.964.020



DO.963.010
Mini



DO.963.020
Midi



DO.963.030
Maxi



DO.963.040
X-Large

Covered pliers rack
Stojak na kleszcze



DO.966.000

Silicone grips for orthodontic pliers
Silikonowe nakładki na uchwyty kleszczy ortodontycznych

Pair / Para



Autoclavable
Możliwość sterylizacji w autoklawie

Comfortable
Non Slip
Reduce hand fatigue
Easy to put on and off

Wygodne
Nieślizgują się
Zmniejszają zmęczenie dłoni
Łatwe do zakładania i zdejmowania

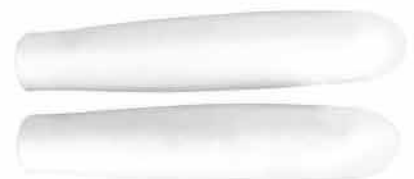

DO.950.010
White / Białe



Lips and cheek retractors
Rozwieraki do policzków i ust



Autoclavable
Możliwość sterylizacji w autoklawie

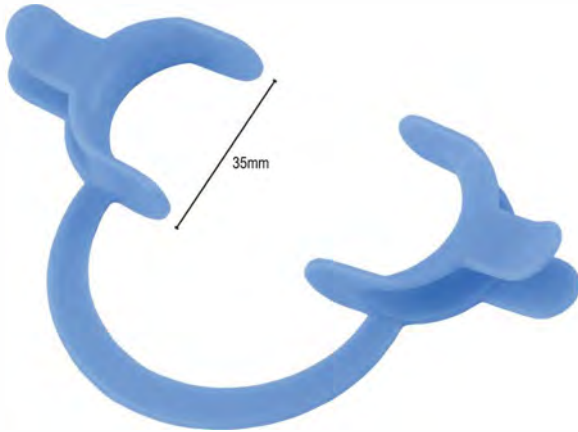

For child / Dla dzieci
DS.426.010

Lips and cheek retractors
Rozwieraki do policzków i ust



Autoclavable
Możliwość sterylizacji w autoklawie

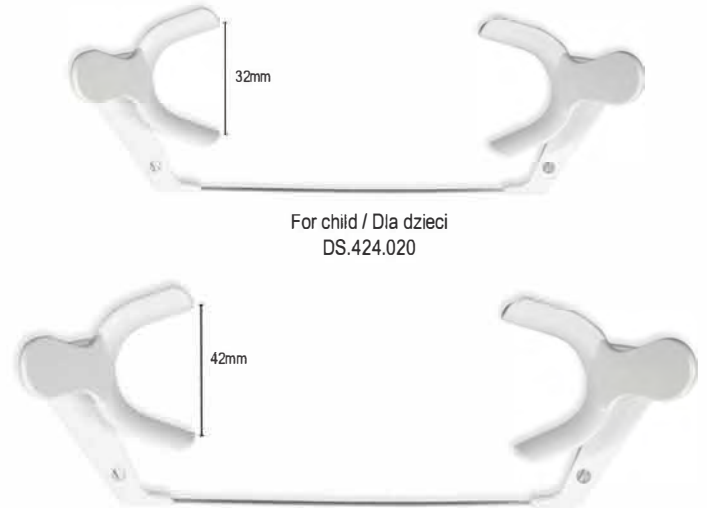

For child / Dla dzieci
DS.424.020

For adult / Dla dorosłych
DS.424.030

Lips and cheek retractor with tongue retainer
Rozwierak do policzków i ust z blokadą języka



Autoclavable
Możliwość sterylizacji w autoklawie



Small / Mały
DS.423.010



Medium / Średni
DS.423.020



Large / Duży
DS.423.030

Lips and cheek retractor with tongue retainer
Rozwierak do policzków i ust z blokadą języka



Autoclavable
Możliwość sterylizacji w autoklawie



Small / Mały
DS.423.060



Large / Duży
DS.423.070

Photo cheek retractors
Rozwieraki do zdjęć

Autoclavable
Możliwość sterylizacji w autoklawie

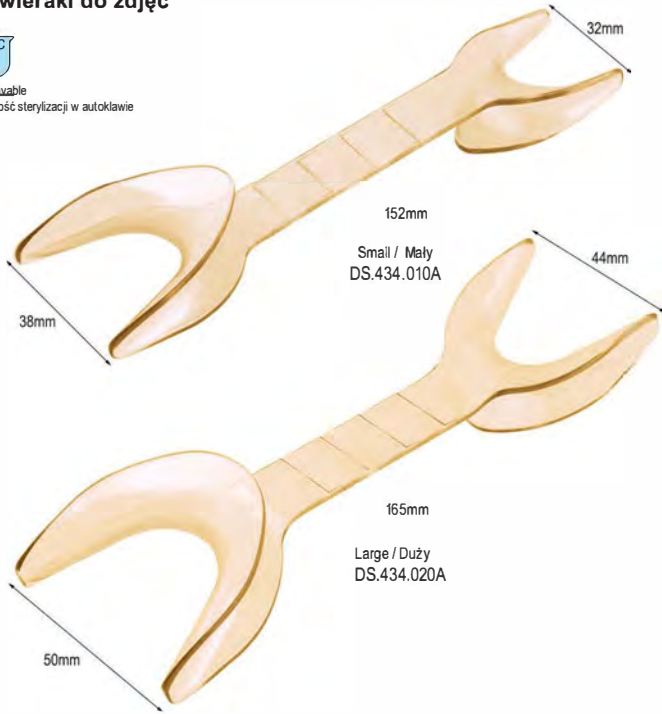
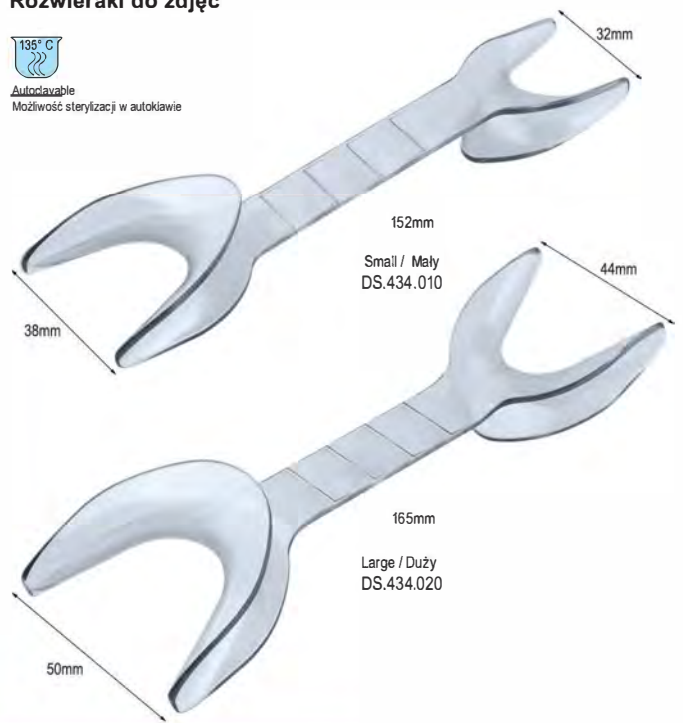

Photo cheek retractors
Rozwieraki do zdjęć

Autoclavable
Możliwość sterylizacji w autoklawie



Lips and cheek retractor with tongue retainer
Rozwierak do policzków i ust z blokadą języka

Autoclavable
Możliwość sterylizacji w autoklawie



Photo cheek retractors
Rozwieraki do zdjęć

Autoclavable
Możliwość sterylizacji w autoklawie



Lips retractors
Rozwieraki do warg

Autoclavable
Możliwość sterylizacji w autoklawie



Small / Mały
DS.422.010

Large / Duży
DS.422.020



Soft retractor lips and cheek
Rozwierak do policzków i ust miękkie

Cold sterilization only
Sterylizacja na zimno



Autoclavable
Możliwość sterylizacji w autoklawie

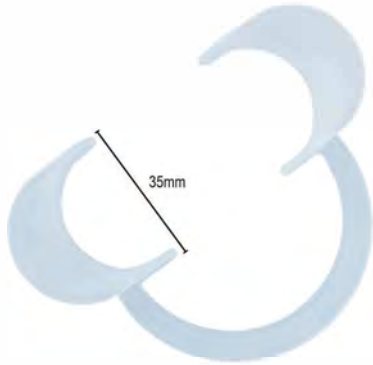

Small / Mały
DS.425.010

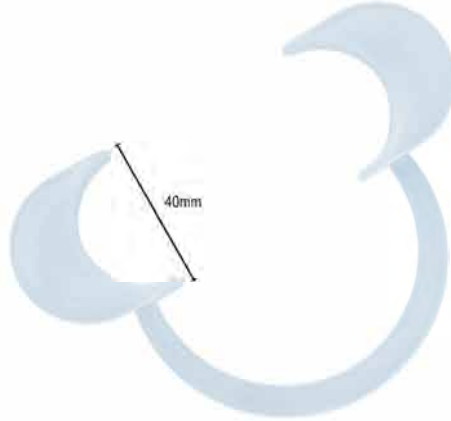

Medium / Średni
DS.425.020

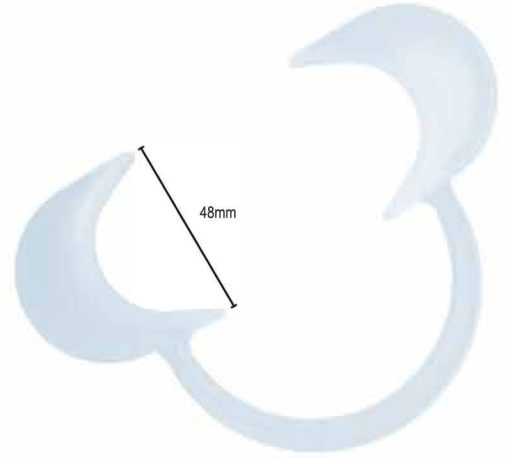

Large / Duży
DS.425.030

Transparent retractors
Rozwieraki przezroczyste



Autoclavable
Możliwość sterylizacji w autoklawie



Small / Mały
DS.425.040

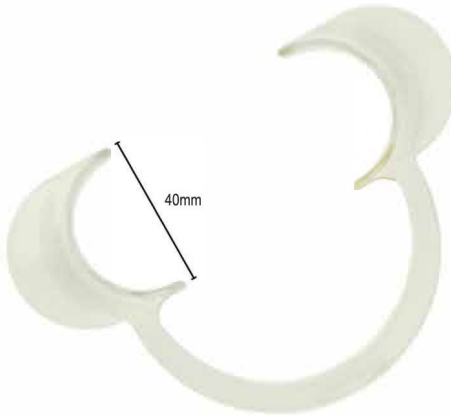

Medium / Średni
DS.425.050

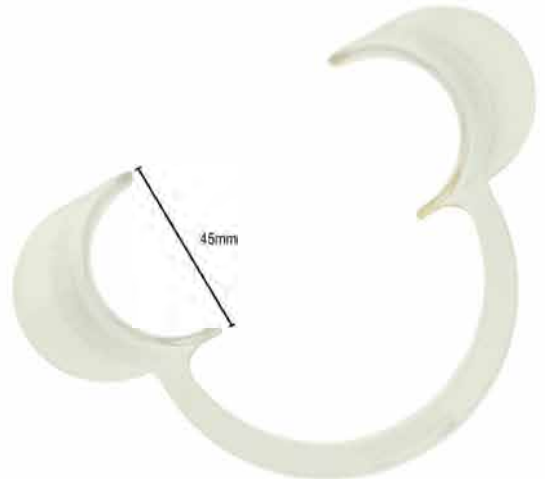

Large / Duży
DS.425.060

Nola - Dry Field System
System osuszający i rozwierający Nola

Designed for photographic retraction. Autoclave (121°C) or cold sterilization (glutaraldehyde only). Provides a totally dry field without cotton rolls. Comes with silicone tubing.



Complete set / Zestaw



DS.424.041 for child / dla dzieci
DS.424.051 for adult / dla dorosłych
Tongue guard with position block
2 pieces of silicone tube and Y - pipe



Code / Kod	Size / Rozmiar
DS.424.040	for child / dla dzieci
DS.424.050	for adult / dla dorosłych

Extraoral retractors
Rozwierak zewnętrzny

Better access for the dentist to the teeth to perform clinical procedures, gives full view of anterior/posterior segment during direct bonding. Handles for easier insertion and for pulling the cheek anterior while bonding the side segment. Tension can be adjusted by using elastomers for maximum patient comfort, also keeps the upper and lower lip away from dry-field while bonding



 Autoclavable
Możliwość sterylizacji w autoklawie

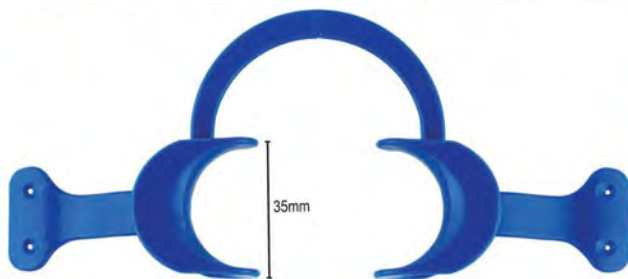

For child / Dla dzieci
DS.423.080

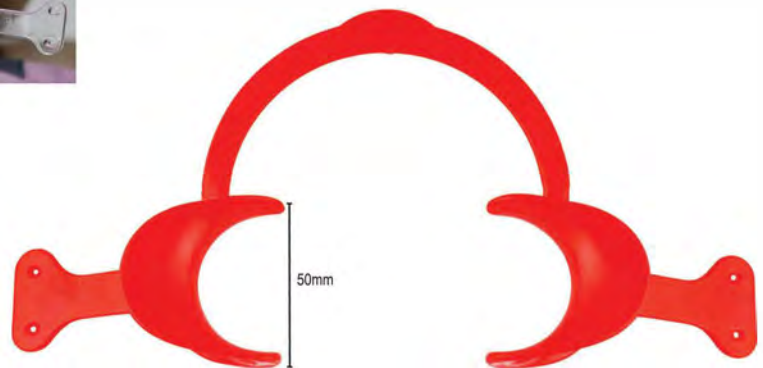

For adult / Dla dorosłych
DS.423.090

Photography Lip retractor
Rozwierak wargowy do zdjęć



Photo cheek retractors
Rozwieraki policzkowe do zdjęć

 Autoclavable
Możliwość sterylizacji w autoklawie



DS.435.020
Simplex-Falcon



DS.434.030
Large / Duży

V shaped, black
V shaped, czarny



DS.434.040
Small / Mały

 Autoclavable
Możliwość sterylizacji w autoklawie

 Autoclavable
Możliwość sterylizacji w autoklawie

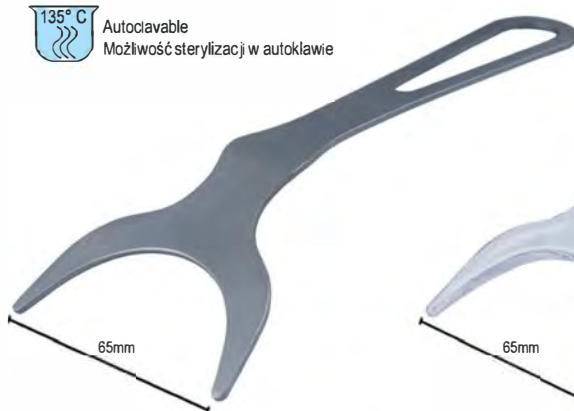

Stainless steel / Stal nierdzewna
DS.437.010
170mm



Plastic / Plastikowy
DS.437.020
170mm



Plastic / Plastikowy
DS.437.030
170mm



Handle for photographic mirrors
Uchwyt do lusterka fotograficznego



DD.472.000 Stainless Steel / Stal nierdzewna
DD.472.010 Silver
DD.472.020 Black
DD.472.030 Green
DD.472.040 Pink

Disposable tongue blocks with saliva ejectors
Jednorazowe blokady języka ze ślinociągiem

Helps maintain a dry field / Pomagają utrzymać suchą powierzchnię
Enable patient to relax jaw / Zapewniają odpoczynek szczękom pacjenta



Tongue blocks
Blokada języka

Saliva ejectors
Ślinociąg

Adaptertubes
Złącza do ślinociągu

DZ.5000.01 Small / Mała
DZ.5000.02 Medium / Średnia
Pack of 50 pieces
Opak. 50 szt.

DZ.5003.00
Pack of 3 pieces
Opak. 3 szt.

DZ.5004.00
Pack of 3 pieces
Opak. 3 szt.

Impression protector
Pasek ochronny na zamki ortodontyczne



DI.015.000
Pack of 10 pairs / Opak. 10 par
Allows to take good impression while patient is wearing braces
by preventing alginate adhering to brackets.

Pozwala uzyskać prawidłowy wycisk podczas noszenia aparatu stałego,
zapobiega przyklejaniu masy do zamków

Plastic model bases
Jednorazowa plastikowa forma do modeli kontrolnych



Complete upper and
lower with hinges
Komplet górny i dolny z
zawiasami

Standard / Standard DL.090.010
Large / Duża DL.090.020

Bite registration wafers
Wafle do rejestracji zgryzu

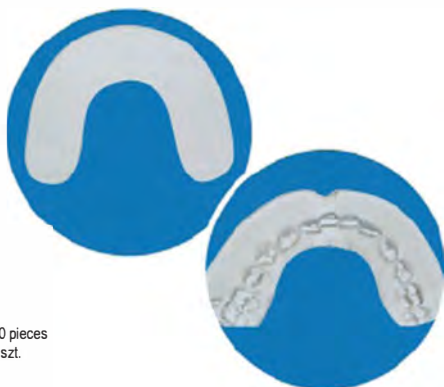

Pack of 10 pieces
Opak. 10 szt.

DI.003.000
Provides clear impression of teeth
Zapewniają wyraźną rejestrację zgryzu

Rubber model bases
Gumowa forma do modeli



Set of 6 pieces, assorted sizes,
upper and lower
Zestaw 6 szt., różne rozmiary,
górną i dolną

DL.091.010

Pro-Lock Disposable orthodontic impression trays
Pro-Lock Jednorazowe Ortodontyczne łyżki wyciskowe

Pack includes 10 trays of 1 size
Opak.zawiera 10 łyżek z 1 rozmiaru



Tuff-Lock Disposable orthodontic impression trays
Tuff-Lock Jednorazowe Ortodontyczne łyżki wyciskowe

Pack includes 10 trays of 1 size
Opak.zawiera 10 łyżek z 1 rozmiaru





Template cephalometric / Szablon cefalometryczny

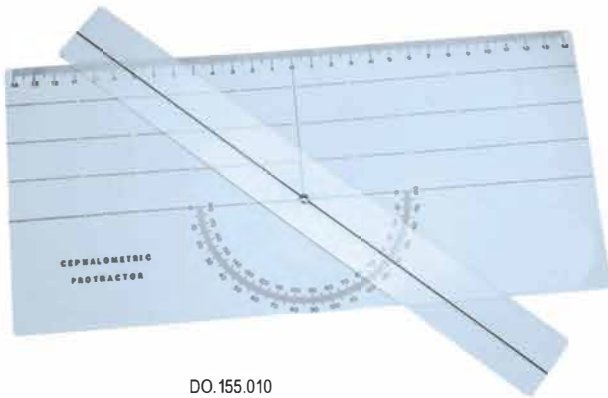

DO.155.010

**Cephalometric protractor and tracing template
Kątomierz cefalometryczny i szablon ortodontyczny**

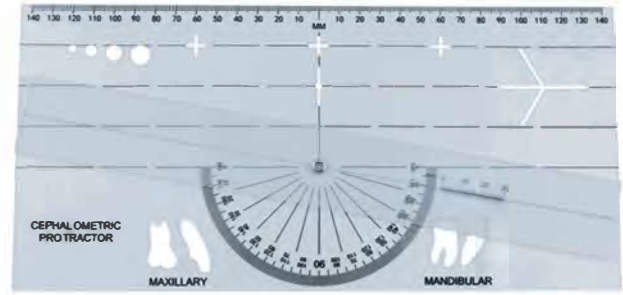

DO.155.011

Template tracing / Szablon ortodontyczny

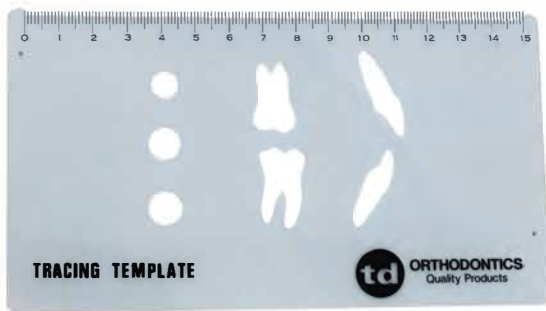

DO.155.020

**Cephalometric triangle
Szablon cefalometryczny trójkąt**

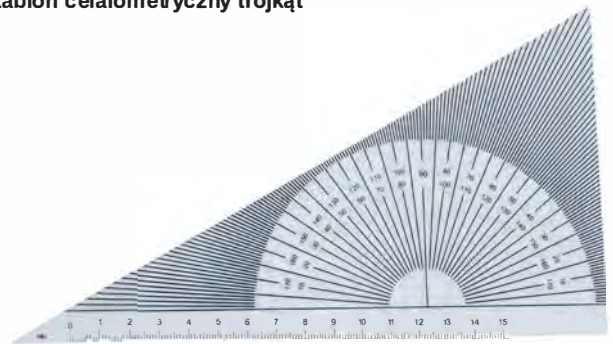

DO.155.070

Template corrolometer / Korelometr



DO.155.030

Template Rickets / Szablon Ricketa

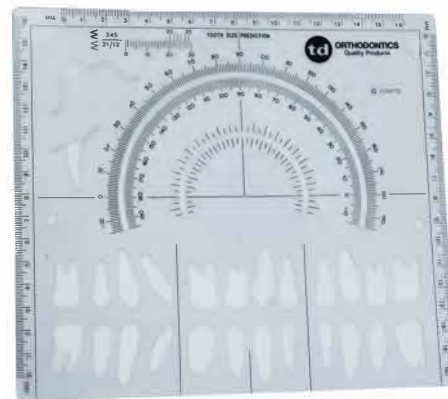

DO.155.040

**Cephalometric tracing film
Kalka cefalometryczna**



DO.156.100
8" x 10" (200 mm x 250 mm)
100 sheets / 100 kartek

**Tracing pencils
Ołówki do zaznaczania**



DO.156.010 Black / Czarne
DO.156.020 Blue / Niebieskie
DO.156.030 Red / Czerwone
DO.156.040 Green / Zielone
DO.156.050 White / Białe
DO.156.060 Yellow / Żółte