

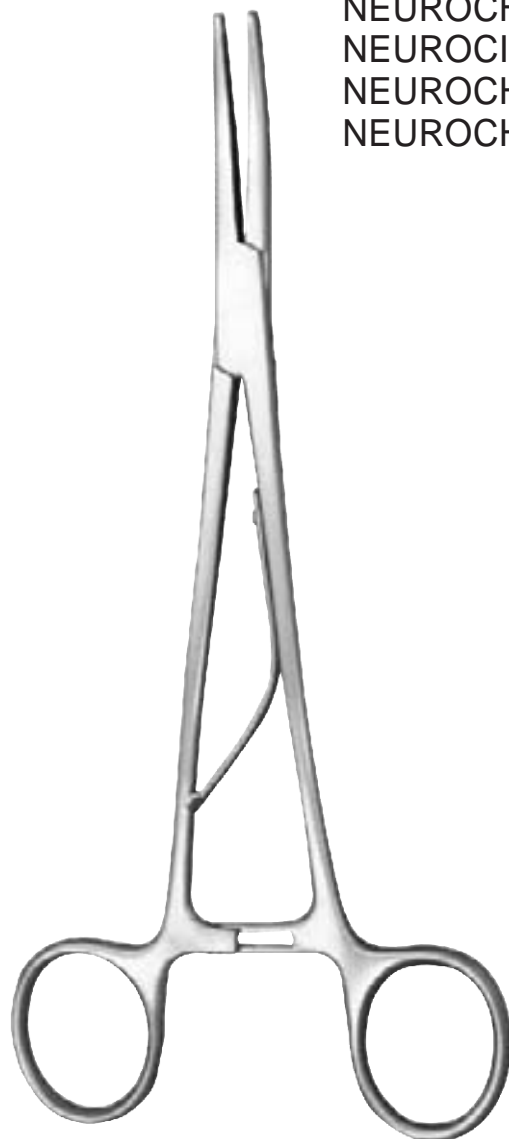

26

NEUROSURGERY, LAMINECTOMY

NEUROCHIRURGIE, LAMINEKTOMIE
NEUROCIRUGÍA, LAMINECTOMÍA
NEUROCHIRURGIE, LAMINECTOMIE
NEUROCHIRURGIA, LAMINECTOMIA



Wire Saws, Cranial Rongeurs

Drahtsägen, Schädelzangen

Fils-scies, Pincas emporte-Pièces crâniennes

Sierras de hilo, Pinzas sacabocados craneales

Fili sega, Pinze per craniectomia

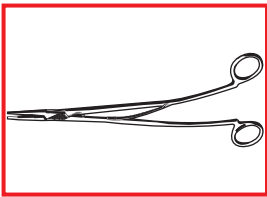

1/2

Martal
26-618-33
33 cm / 13"

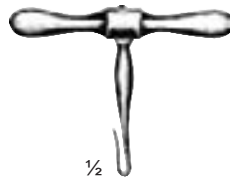

1/2

Gigli
26-620-01



Olivecrona
26-622-30 - 26-622-70

- 26-622-30 = 30 cm / 12"
- 26-622-40 = 40 cm / 16"
- 26-622-50 = 50 cm / 20"
- 26-622-60 = 60 cm / 24"
- 26-622-70 = 70 cm / 28"



1/2

De Vilbiss
26-624-21
21 cm / 8 1/4"



1/2

Dahlgren
26-626-20
20 cm / 8"

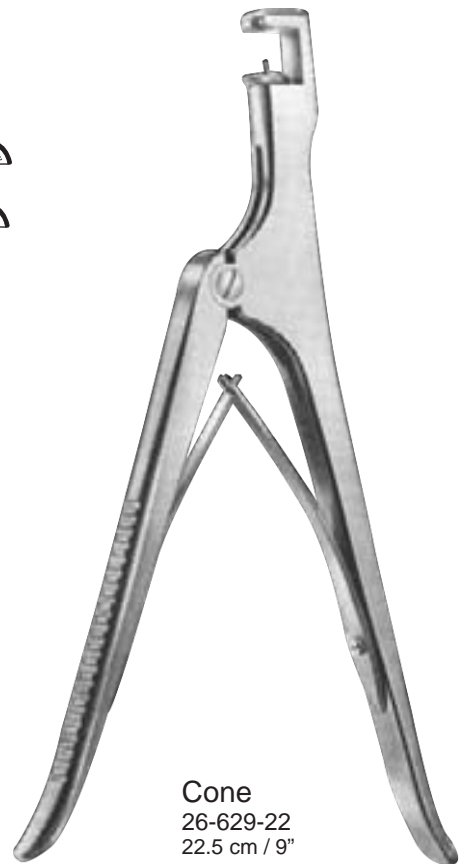

Cone
26-629-22
22.5 cm / 9"

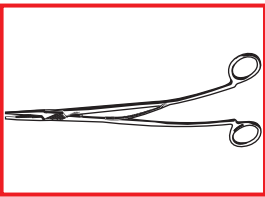

Skull Traction Tongs

Schädelhalter
Estribos de tracción craneal

Pinces de tracción crânienne
Pinze per trazione craniale

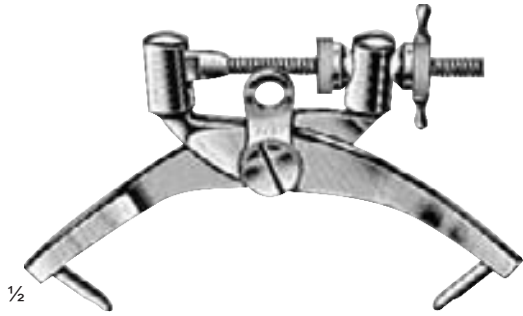

Crutchfield
26-631-01
Cervical Traction Tongs, small size

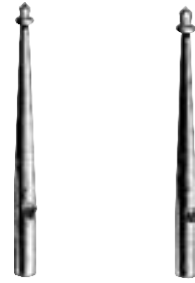

26-631-04 26-631-05
3.5 mm ø 5 mm ø
Drill points for Cervical Traction Tongs
7 cm / 2¾"



Crutchfield
26-631-02
Cervical Traction Tongs, medium size



26-636-01
Pins for children
ø 3.5 mm
26-636-02
pins for adults
ø 4.5 mm



26-633-01
26-633-10

26-633-01
Cervical Traction Tongs, for extension of the
neck vertebrae, large size,

26-633-10
Spare pin only

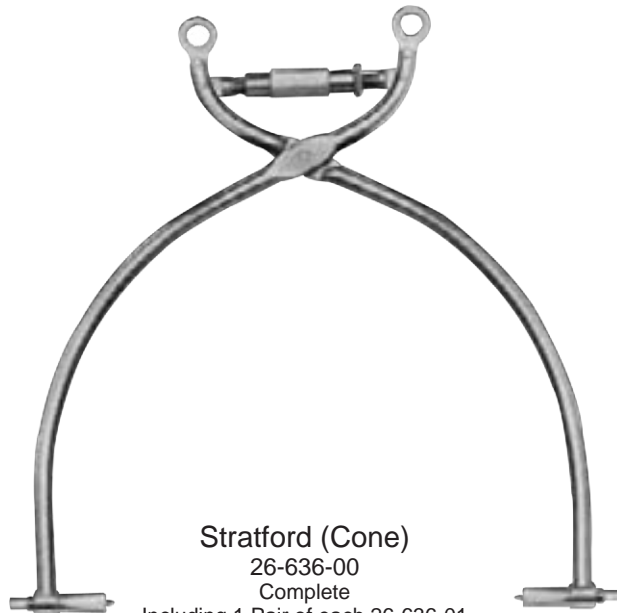

Stratford (Cone)
26-636-00
Complete
Including 1 Pair of each 26-636-01
and 26-636-02 pins and one combined
spanner and wrench 26-636-03



26-636-03
Combined
spanner and
wrench

Clips and Applying Forceps

Clips und Anlegezangen
 Grapas y pinzas aplicadoras

Clips et pinces pour appliquer
 Agrafes e pinze per applicare

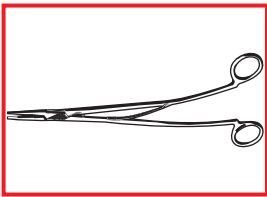

Smithwick
 26-639-23 = 23 cm / 9"
 26-639-26 = 26 cm / 10 1/4"

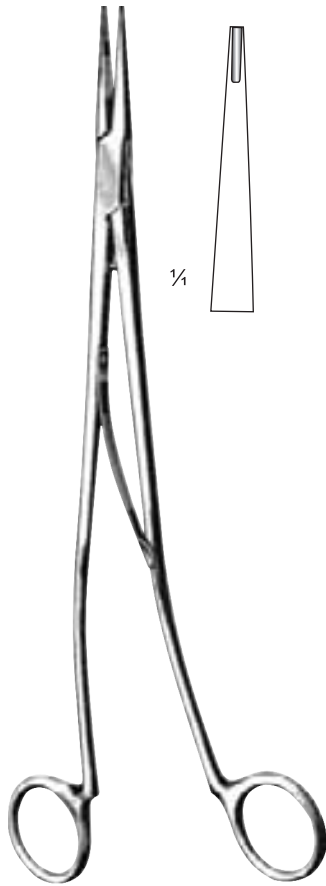

Sweet
 26-641-23 = 23 cm / 9"
 26-641-25 = 25 cm / 10"

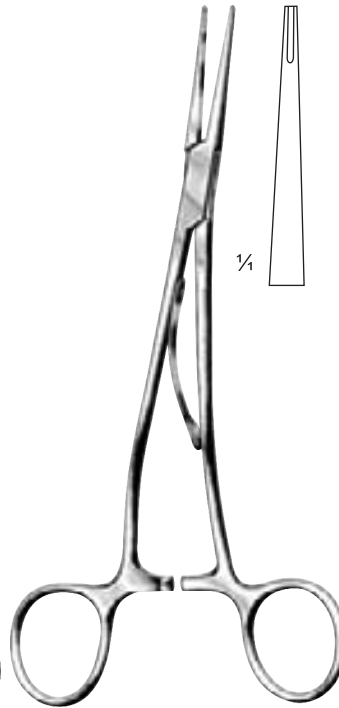

McKenzie
 26-643-15 = 15 cm / 6"
 26-643-19 = 19 cm / 7 1/2"

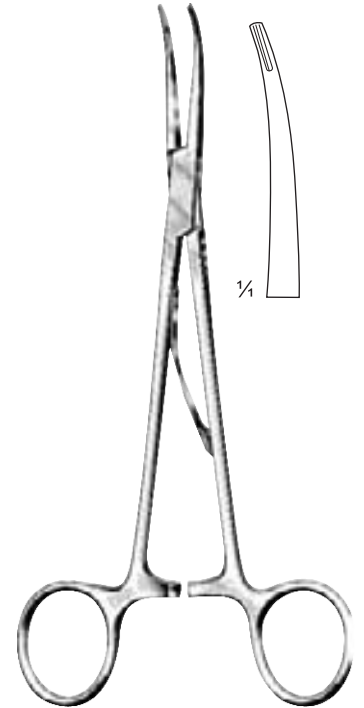

McKenzie
 26-645-15 = 15 cm / 6"
 26-645-19 = 19 cm / 7 1/2"

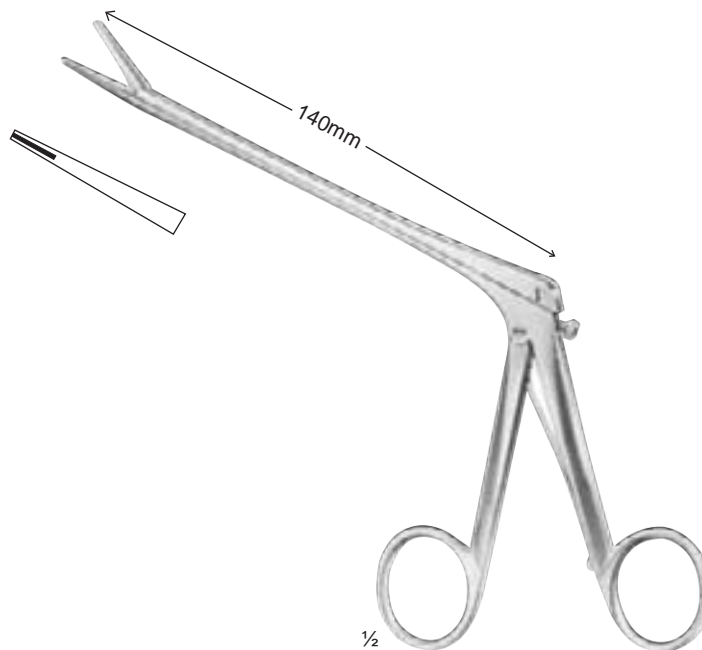

Olivecrona-Toennis
 (Scoville)
 26-647-14

Clips and Applying Forceps

Clips und Anlegezangen
 Grapas y pinzas aplicadoras

Clips et pinces pour appliquer
 Agrafes e pinze per applicare

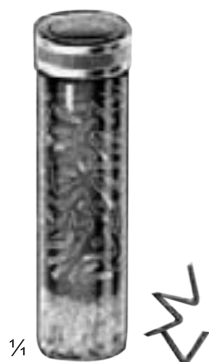
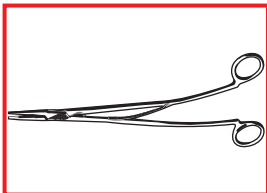

26-650-00
 Silver Brain Clips
 (100Pcs)



McKenzie
 26-653-00
 Silver Wire in coil
 of 2.5g



Raney
 26-656-16
 16 cm / 6¼"



Kolner Sparklammern
 26-658-00
 Scalp Clip



Raney
 26-661-00
 Scalp Clip

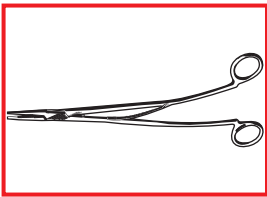

Dura Dissectors

Duradisektoren
Disecadores para duramadre

Dissecteurs à dure-mère
Dissettori per la dura-madre

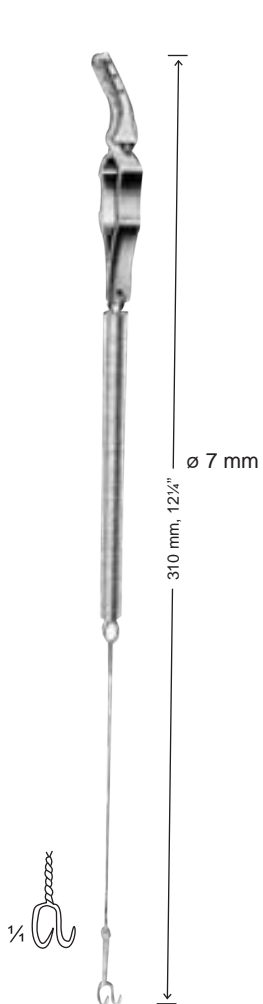
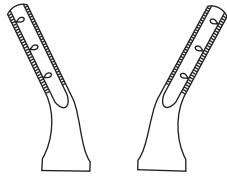
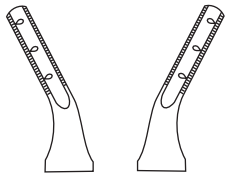

Yasargil
26-664-01
31 cm / 12 1/4"

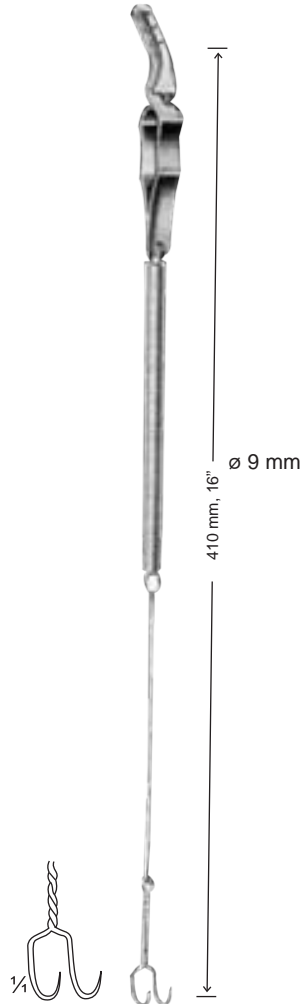

Yasargil
26-666-02
41 cm / 16"

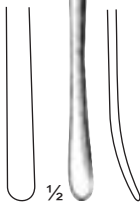
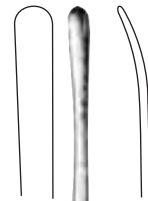

Toennis
26-668-25
25 cm / 10"

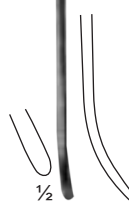
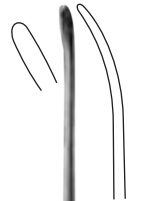

Olivecrona
26-670-18 = 18 cm / 7"
26-670-24 = 24 cm / 9 1/2"

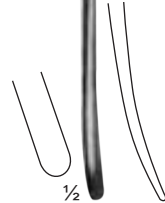
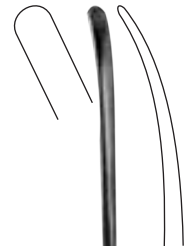

Olivecrona
26-672-19 = 19.5 cm / 7 3/4"
26-672-24 = 24 cm / 9 1/2"

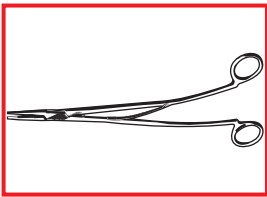

Dura Dissectors

Duradisektoren
Disecadores para duramadre

Dissecteurs à dure-mère
Dissettori per la dura-madre



Penfield
26-674-01
Fig. 1
17.5 cm / 7"



Penfield
26-674-02
Fig. 2
19.5 cm / 7 3/4"



Penfield
26-674-03
Fig. 3
19.5 cm / 7 3/4"



Penfield
26-674-04
Fig. 4
21.5 cm / 8 1/2"



Penfield
26-674-05
Fig. 5
18.5 cm / 7 1/4"



Sachs
26-677-21
21 cm / 8 1/4"



Milligan
26-680-21
21 cm / 8 1/4"



Davis
26-683-21
21 cm / 8 1/4"

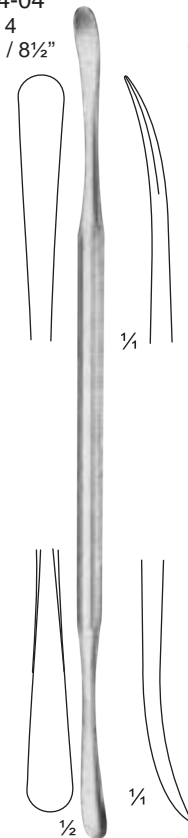

26-686-22
22 cm / 8 3/4"

Dura Dissectors, Nerve Root Retractors

Duradissektoren, Nervwurzelhaken

Dissecteurs à dure-mère, Retracteurs pour racines nerveuses

Disecadores para duramadre, Separadores para la raíz de nervio

Dissettori per la dura-madre, Uncini per le radici die nervi

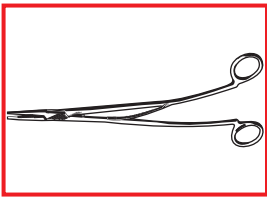

Davis
26-689-24
24.5 cm / 9 3/4"



Frazier
26-691-15
15 cm / 6"



Hoen
26-693-01
15 cm / 6"



Hoen
26-693-02
15 cm / 6"

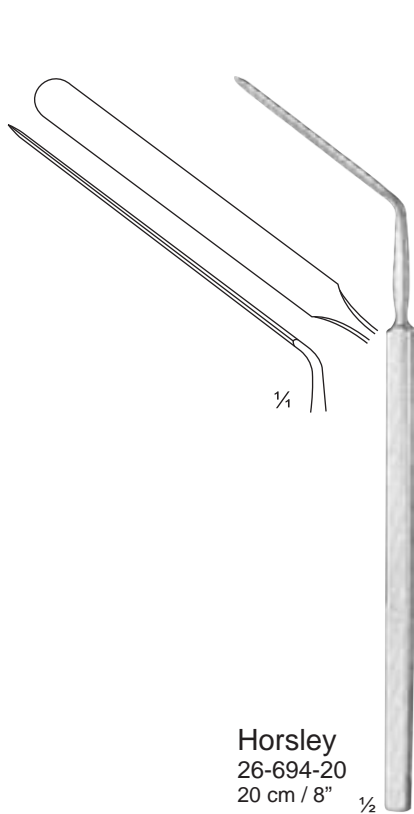

Horsley
26-694-20
20 cm / 8"

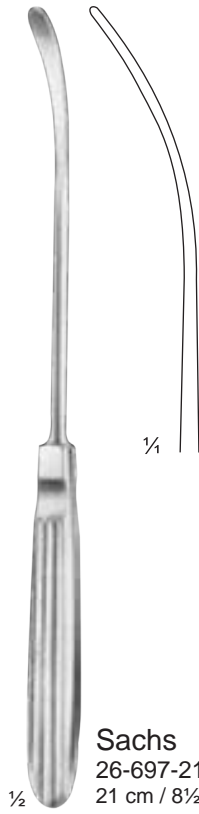

Sachs
26-697-21
21 cm / 8 1/2"

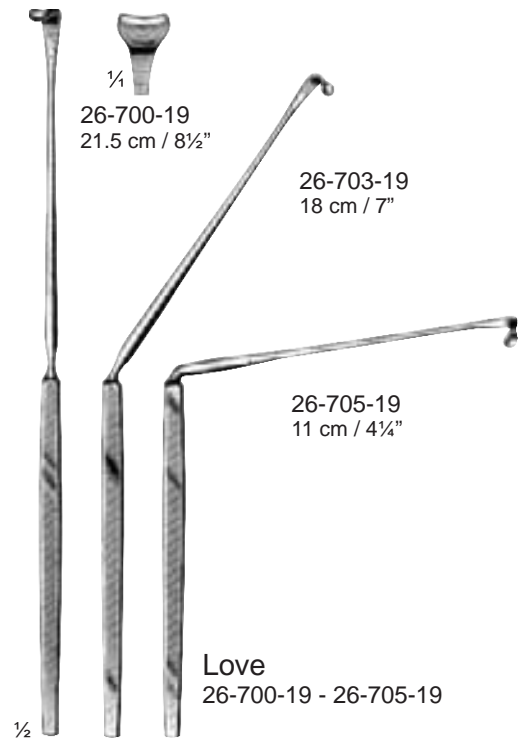

26-700-19
21.5 cm / 8 1/2"

26-703-19
18 cm / 7"

26-705-19
11 cm / 4 1/4"

Love
26-700-19 - 26-705-19

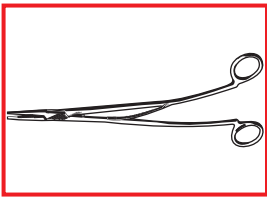

Brain Spatulas

Hirnspatel Spatules cérébrales
 Espátulas cerebrales Spatole cerebrali



Olivecrina
 18 cm / 7"

width of spatulas

concave	upper end mm	Lower end mm	convex
26-707-18	7	9	26-715-18
26-709-18	11	13	26-717-18
26-711-18	15	18	26-719-18
26-713-18	18	22	26-721-18

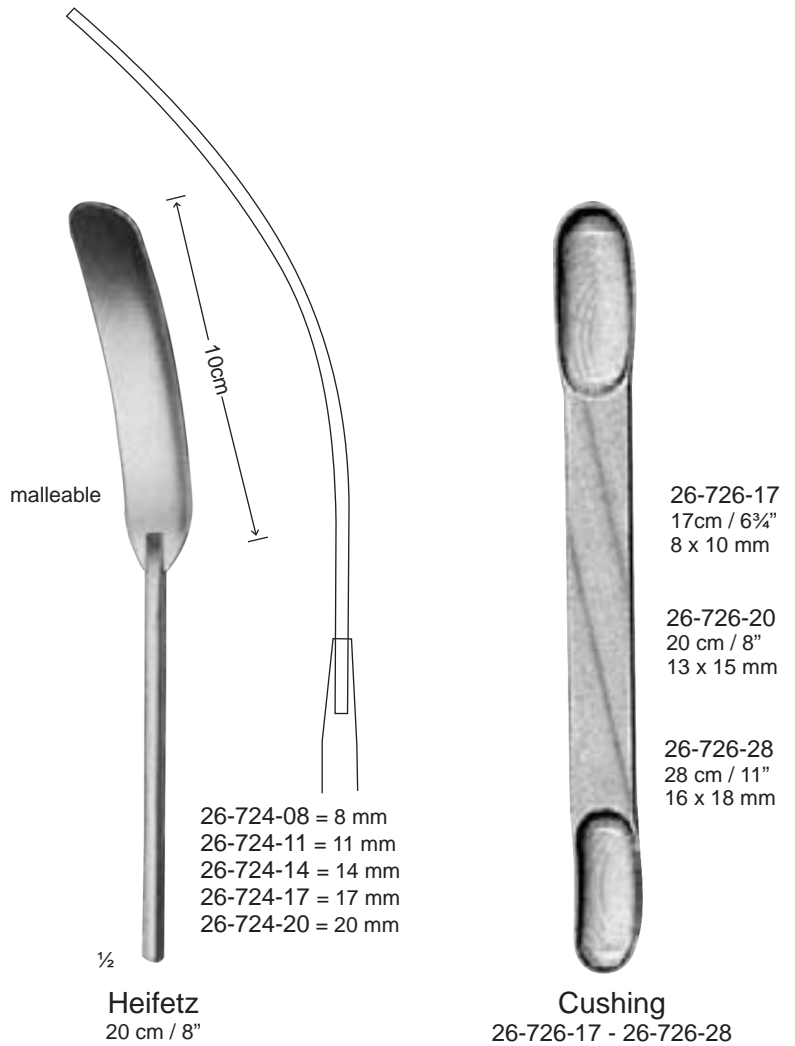

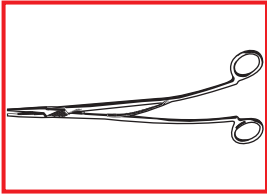

Nerve Root Retractors

Nervwurzelnaken
Separadores para la raíz de nervio

Retractors pour racines nerveuses
Uncini per le radici die nervi

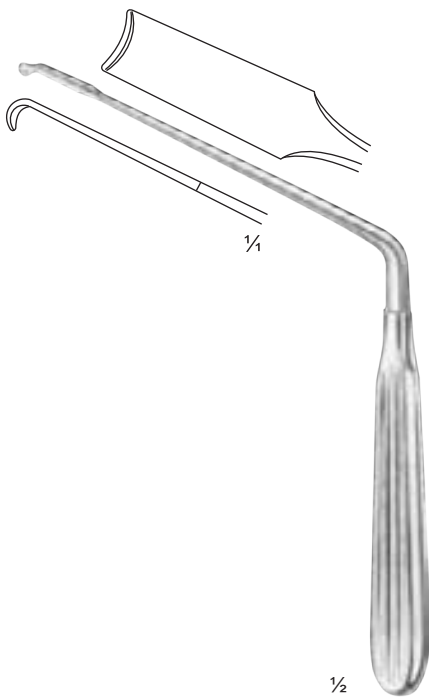

Scoville
26-728-16
16.5 cm / 6½"



Martin
26-731-21
21 cm / 8½"



Grant Massie
26-733-32
32 cm / 12¾"
double-ended



Caspar
26-735-24 = 6 mm wide
26-736-24 = 8 mm wide
26-737-24 = 10 mm wide
24 cm / 9½"



Love
26-740-21
21cm / 8¼"



Scoville
26-742-23
23 cm / 9"

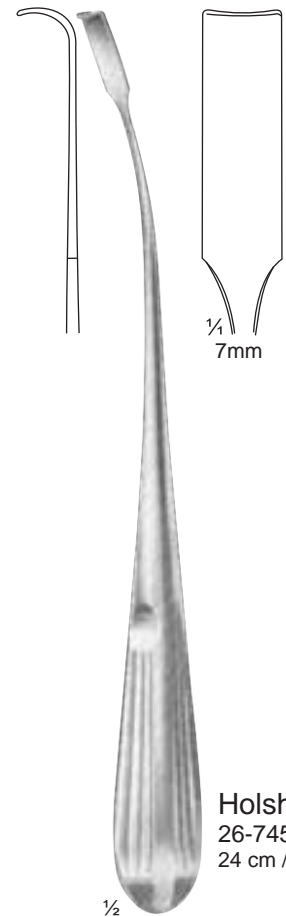

Holsher
26-745-24
24 cm / 9½"

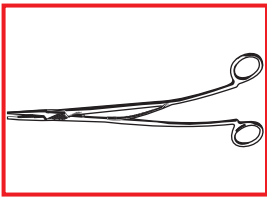

Nerve Hooks

Nervhaken
Ganchos para nervios

Crochets à nerfs
Uncini per nervi



1/4
Scoville
26-747-30
30 cm / 12"



1/4
Scoville
26-749-30
30 cm / 12"



1/4
Smithwick
26-752-29
29 cm / 11 1/2"



Cushing
26-754-19 = 19 cm / 7 3/4"
26-754-28 = 28 cm / 11"



Cushing
26-756-19
26-756-28

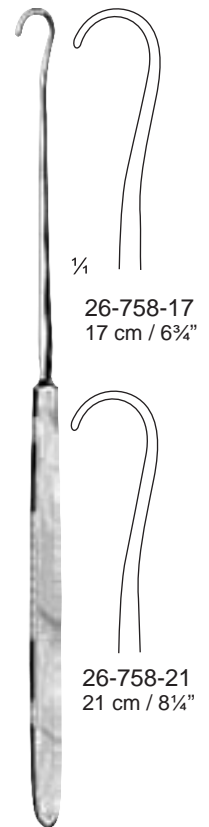

1/4
Smithwick
26-758-17 - 26-758-21
26-758-17
17 cm / 6 3/4"
26-758-21
21 cm / 8 1/4"

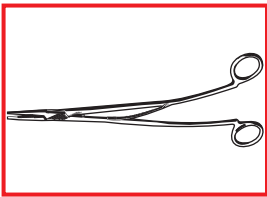

Nerve Hooks

Nervhaken Crochets à nerfs
 Ganchos para nervios Uncini per nervi



26-760-15



26-761-15



26-765-14



26-766-14



26-767-14



1/4
blunt

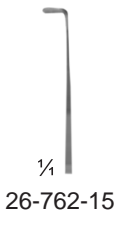

26-762-15

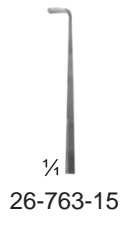

26-763-15



1/2

Wagner
 26-760-15 - 26-763-15
 15 cm / 6"



1/2

Graefe
 26-765-14 - 26-767-14
 14 cm / 5 1/2"



1/2

St. Barts
 26-770-18
 18 cm / 7"



1/4



1/2

Brom
 26-773-17
 17 cm / 6 3/4"



1/4



1/2

Crile
 26-776-20
 20 cm / 8"

Dura Knives, Dura Hooks

Duramesser, Durahaken
Cuchillos para duramadre, Ganchos para duramadre

Couteaux pour dure-mère, Crochets pour dure-mère
Bisturi per dura-madre, Uncini per dura-madre

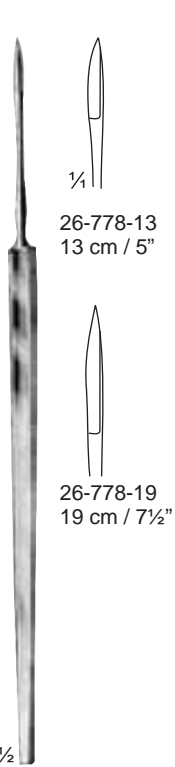
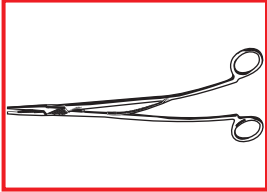

26-778-13
13 cm / 5"

26-778-19
19 cm / 7½"

½

Toennis

26-778-13 - 26-778-19



¼

½

Halle

26-780-20
20 cm / 8"



¼

½

Adson

26-783-20
20 cm / 8"



¼

½

Graham

26-785-16
16.5 cm / 6½"



¼

½

Sachs

26-787-18
18.5 cm / 7¼"



¼

½

Toennis

26-789-15
15 cm / 6"



¼

½

Hoehn

26-791-22
22 cm / 8¾"



¼

½

Dandy

26-794-20
20 cm / 8"

Dura Hooks, Nerve and Vessel Hooklets

Durahaken, Nerv- und Gefäßhäkchen
Ganchos para duramadre, Ganchitos para nervios y vasos

Crochets pour dure-mère, Crochets à nerfs et à vaisseaux
Uncini per dura-madre, Uncini per nervi e vasi

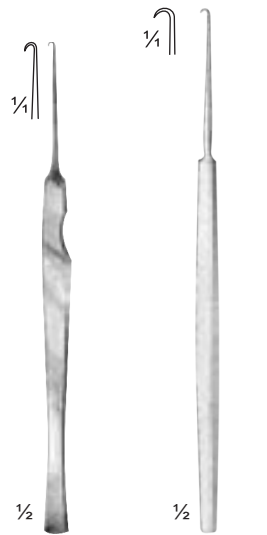
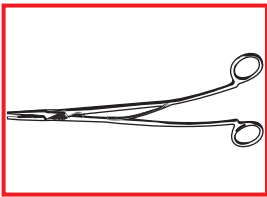

Lahey
26-797-13
13 cm / 5"
Cushing
26-799-14
14 cm / 5½"

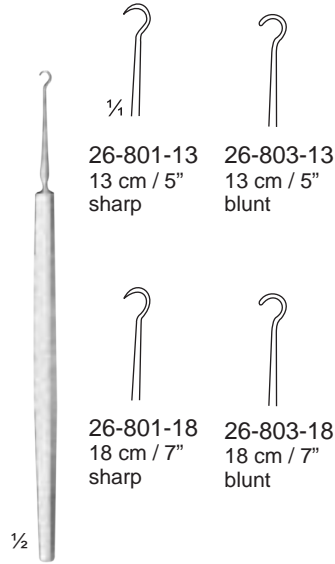

Frazier
26-801-13 - 26-803-18



Adson
26-805-20
20 cm / 8"

Pituitary Curettes

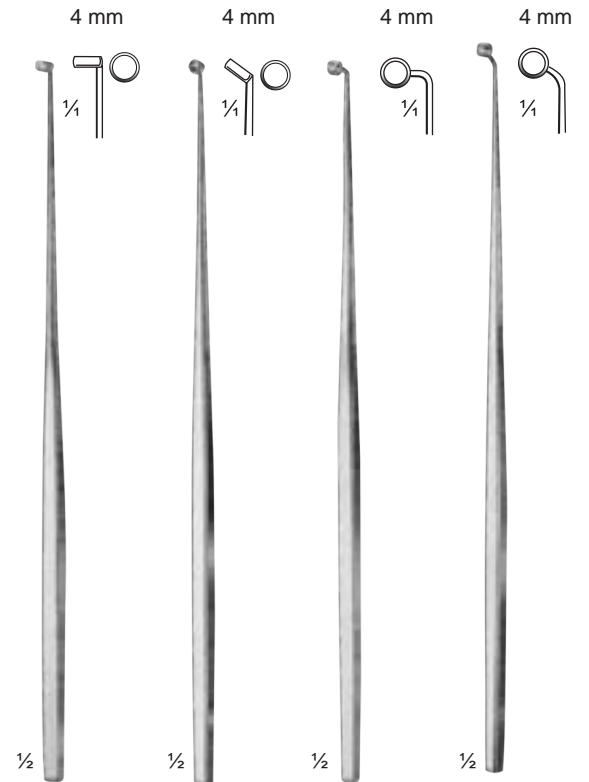

26-808-04 19 cm / 7½"
26-811-04 19 cm / 7½"
26-814-04 19 cm / 7½"
26-817-04 19 cm / 7½"

Micro Nerve and Vessel Hooklets

Mikro Nerv- und Gefäßhäkchen
 Micro Ganchitos para nervios y vasos

Micro Crochets à nerfs et à vaisseaux
 Micro Uncini per nervi e vasi

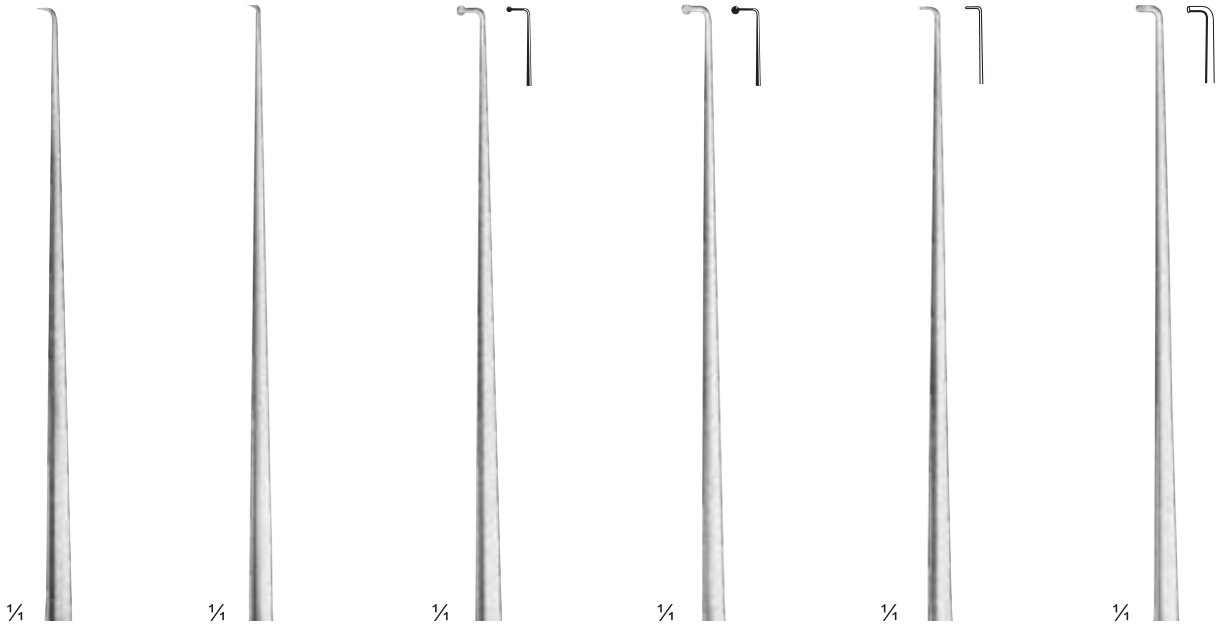
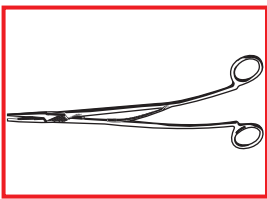

26-820-19
 19 cm / 7½"
 Dura Hook

Fisch
 26-822-19
 19 cm / 7½"
 Delicate Hook

26-824-01
 19 cm / 7½"

26-824-02
 19 cm / 7½"

26-824-03
 19 cm / 7½"

26-824-04
 19 cm / 7½"

Krayenbühl

Nerve and Vessel Hooks

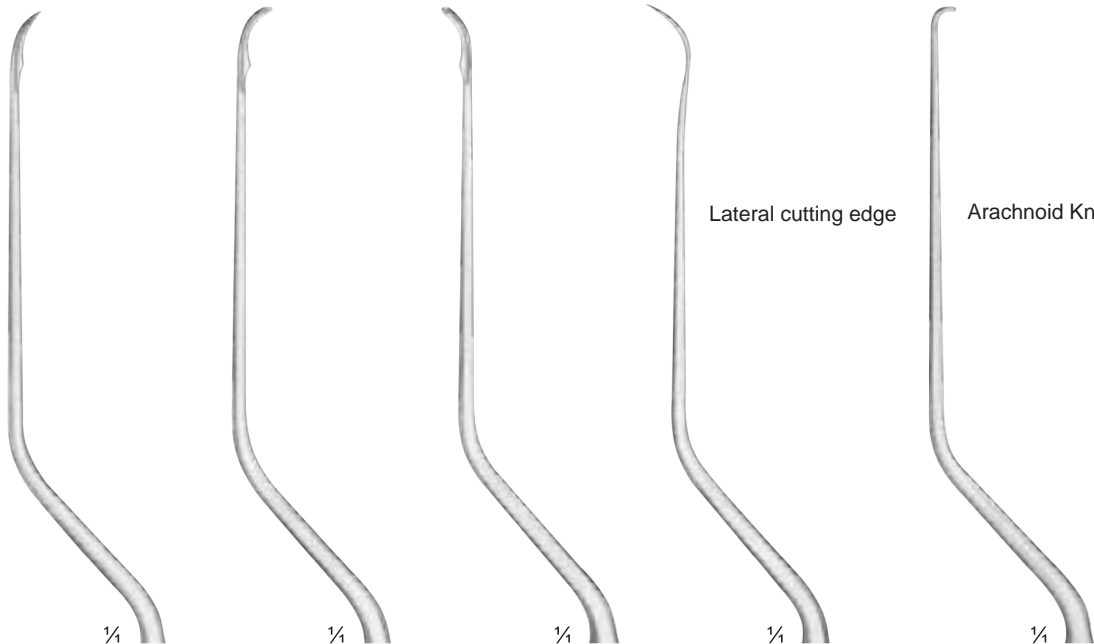

Koos
 26-829-19
 19 cm / 7½"

Koos
 26-831-19
 19 cm / 7½"

Koos
 26-833-19
 19 cm / 7½"

Kraus
 26-835-19
 19 cm / 7½"

Yasargil
 26-837-19
 19 cm / 7½"

1/4
Jacobson
 26-826-19
 19 cm / 7½"

Micro Nerve and Vessel Hooklets

Mikro Nerv- und Gefäßhäkchen
Micro Ganchitos para nervios y vasos

Micro Crochets à nerfs et à vaisseaux
Micro Unicini per nervi e vasi

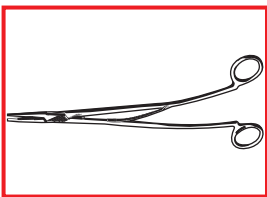

Ligature Guides and Carriers, probe pointed, 4 different shapes

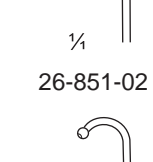
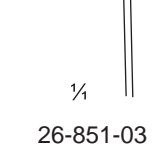
-  1/4
26-851-01
-  1/4
26-851-02
-  1/4
26-851-03
-  1/4
26-851-04

Yasargil
19 cm / 7 1/2"

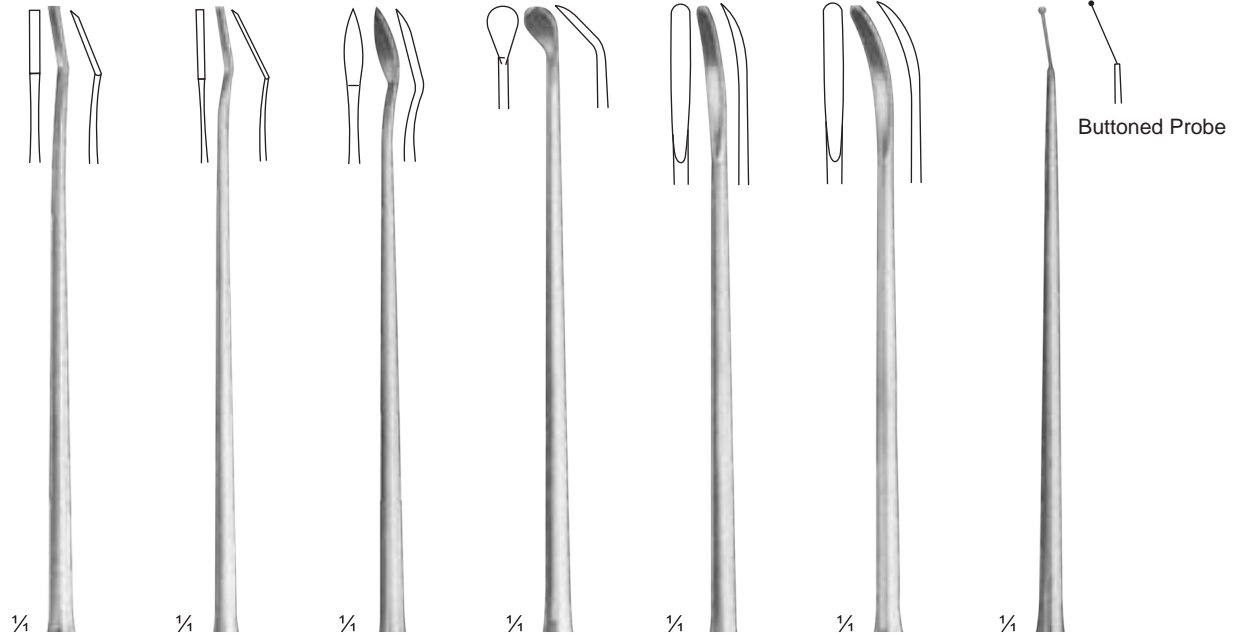

- Yasargil** 26-840-01 19 cm / 7 1/2"
- Yasargil** 26-840-02 19 cm / 7 1/2"
- Yasargil** 26-840-03 19 cm / 7 1/2"
- Yasargil** 26-840-04 19 cm / 7 1/2"
- Yasargil** 26-840-05 19 cm / 7 1/2"
- Yasargil** 26-840-06 19 cm / 7 1/2"
- Jacobson** 26-842-19 19 cm / 7 1/2"

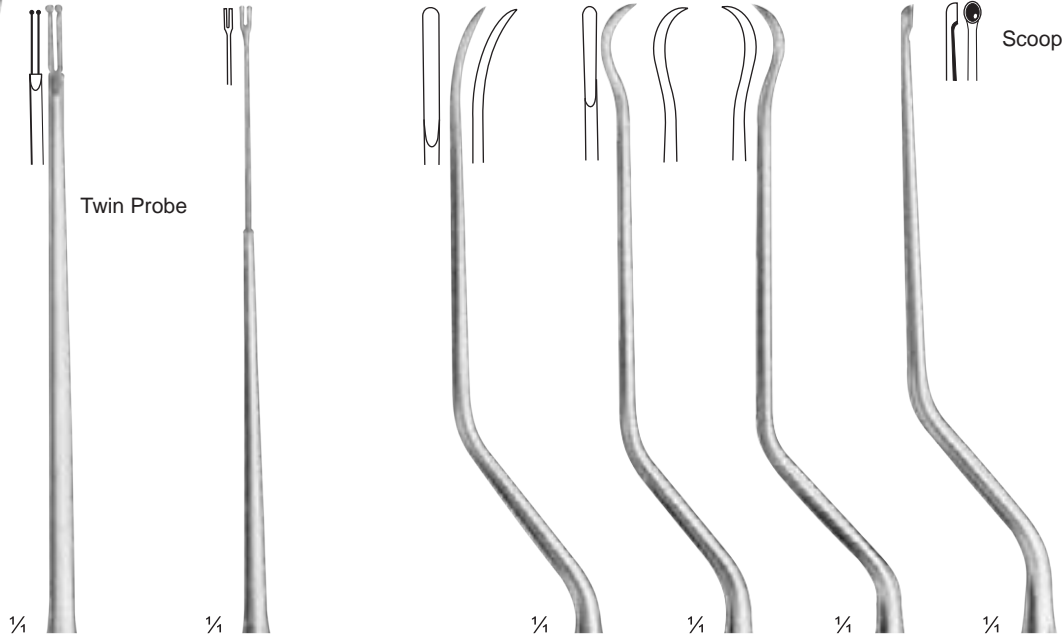

- Jacobson** 26-844-19 19 cm / 7 1/2"
- Yasargil** 26-847-01 19 cm / 7 1/2"
- Yasargil** 26-847-02 19 cm / 7 1/2"
- Yasargil** 26-847-03 19 cm / 7 1/2"
- Yasargil** 26-847-04 19 cm / 7 1/2"
- Yasargil** 26-849-19 19 cm / 7 1/2"

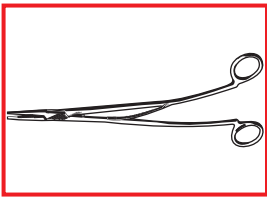

Lamina Spreaders

Wirbelkörperspreizer
Separadores para cuerpos vertebrales

Ecarteurs pour corps vertébraux
Separatori per vertebre

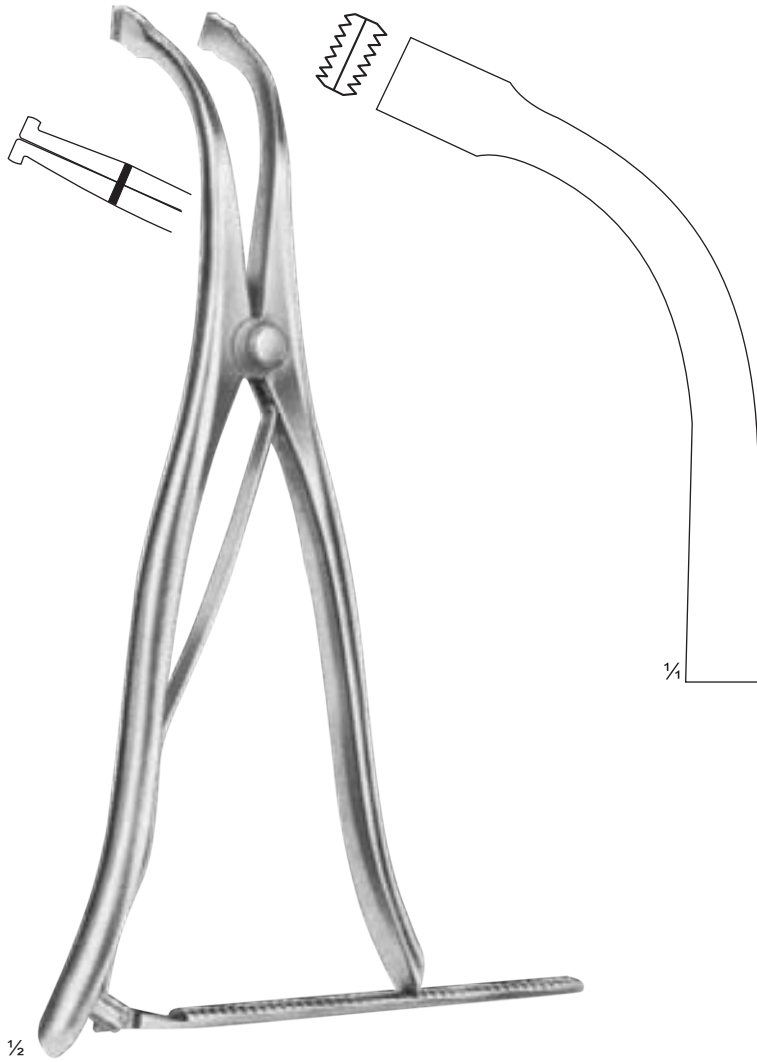

Inge
26-853-27
27 cm / 10 3/4"

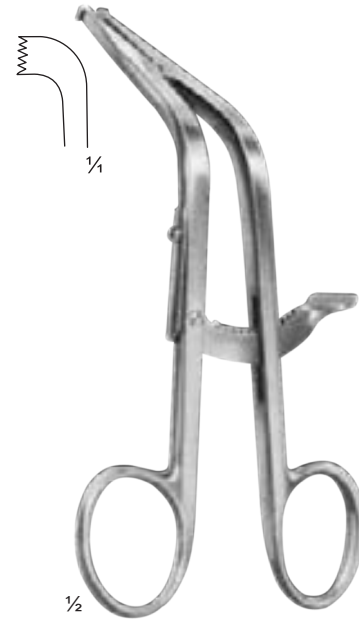

Cloward
26-855-16
16 cm / 6 1/4"

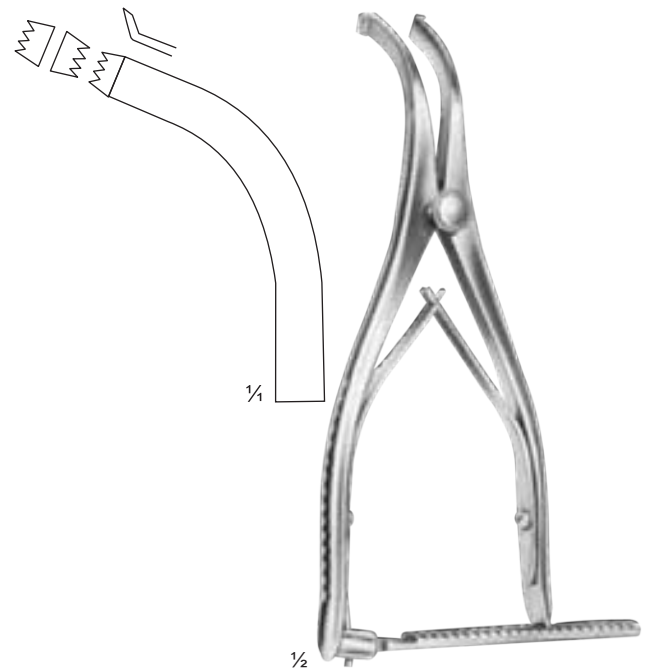

Inge
26-857-17
16.5 cm / 6 1/2"

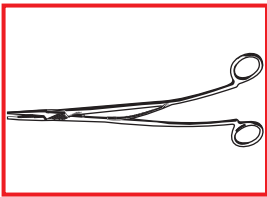

Laminectomy Punches

Laminektomiestanzen
Pinzas cortantes para laminectomía

Pinces emporte-pièces à laminectomie
Pinze tanglienti per laminectomia

¼



width of jaw 4 mm

26-859-04

¼



width of jaw 5 mm

26-859-05

¼



width of jaw 6 mm

26-859-06

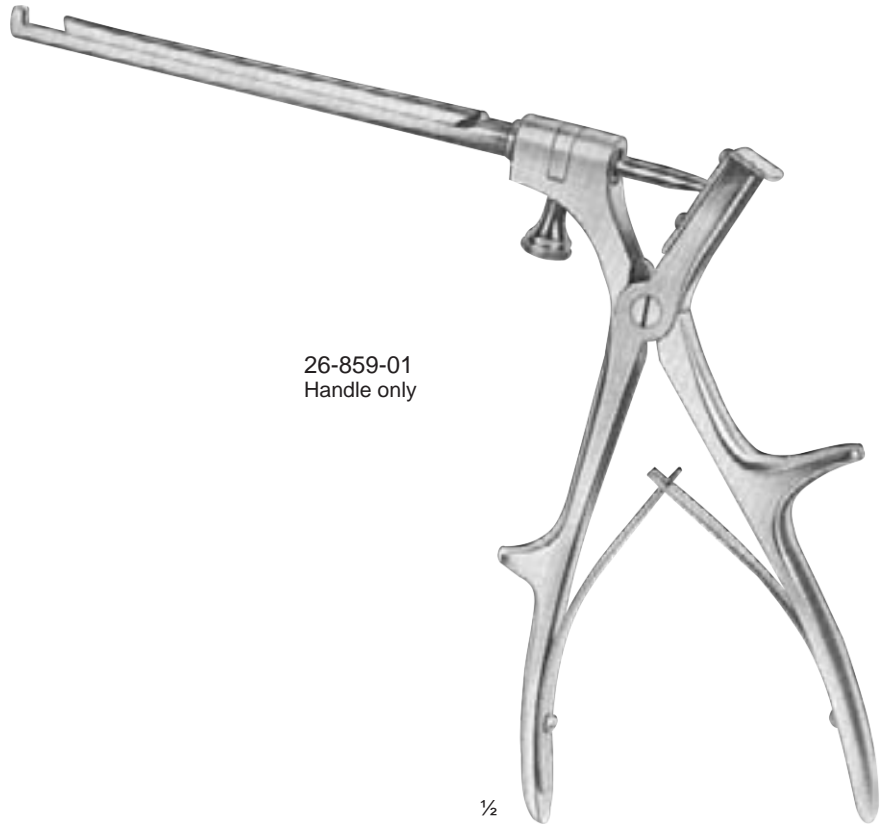

26-859-01
Handle only

½

Colclough
26-859-00
rotating

Handle + 3 interchangeable tips

Laminectomy Punches

Laminektomiestanzen
Pinzas cortantes para laminectomía

Pinces emporte-pièces à laminectomie
Pinze tanglienti per laminectomia

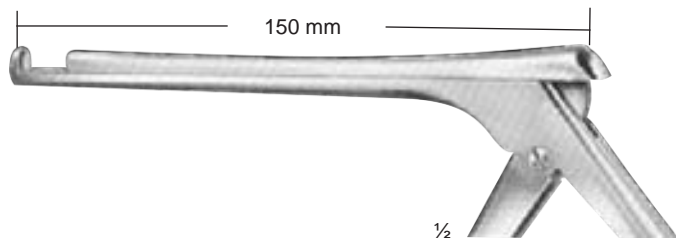
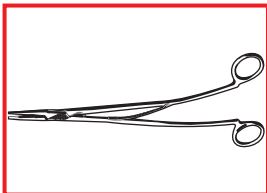

Colclough
26-862-03
26-862-05

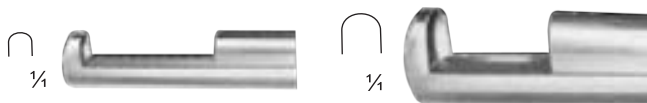

Length of shaft	150 mm 6"	200 mm 8"	150 mm 6"	200 mm 8"
Width of bite	3 mm	3 mm	5 mm	5 mm
Cat. Ref.	26-862-03	26-863-03	26-862-05	26-863-05

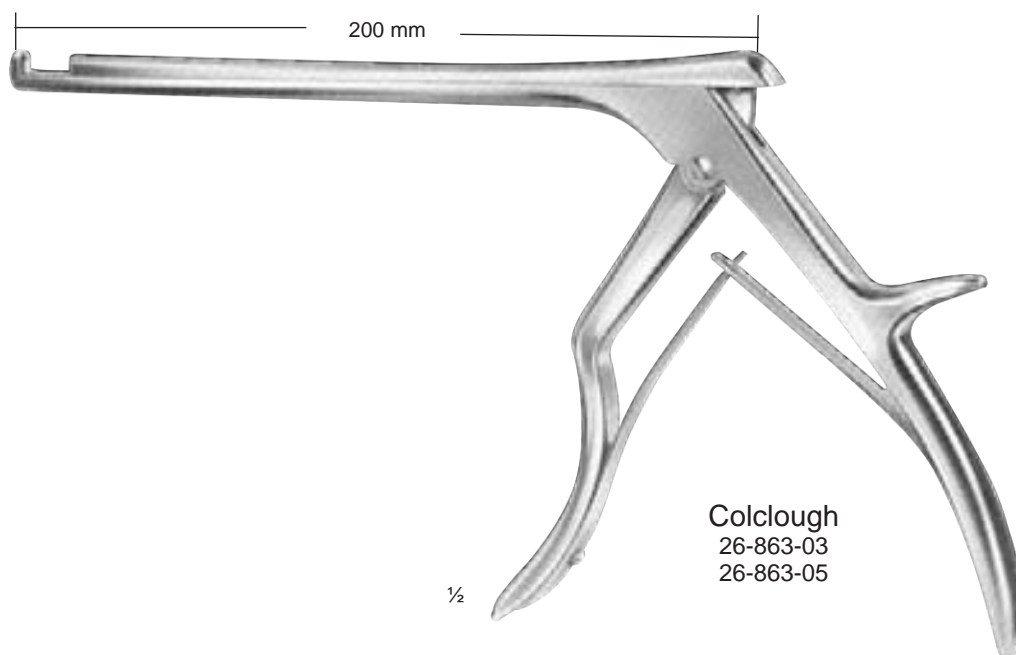

Colclough
26-863-03
26-863-05

Laminectomy Punches

Laminektomiestanzen
Pinzas cortantes para laminectomía

Pinces emporte-pièces à laminectomie
Pinze tanglienti per laminectomia

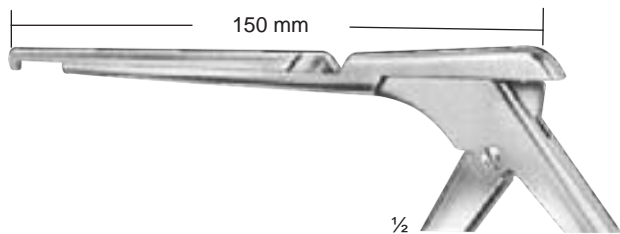
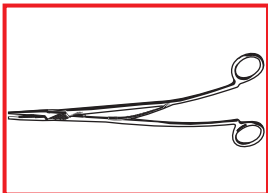

Colclough
26-866-03
26-866-05



Length of shaft	150 mm 6"	200 mm 8"	150 mm 6"	200 mm 8"
Width of bite	3 mm	3 mm	5 mm	5 mm
Cat. Ref.	26-866-03	26-867-03	26-866-05	26-867-05

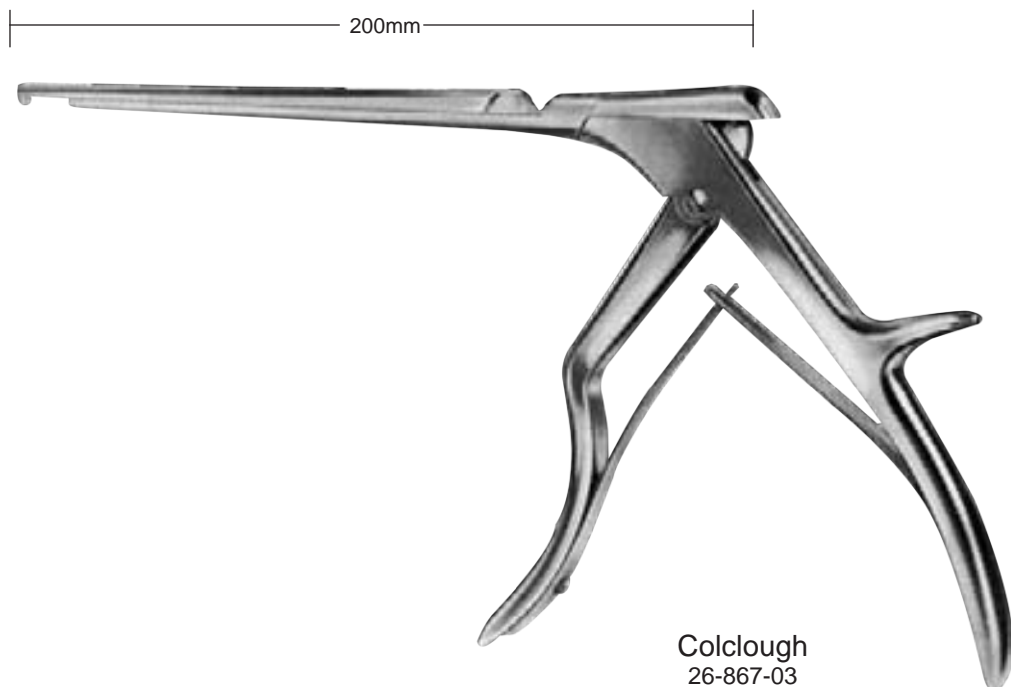

Colclough
26-867-03
26-867-05

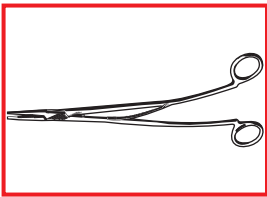

Laminectomy Punches

Laminektomiestanzen
Pinzas cortantes para laminectomía

Pinces emporte-pièces à laminectomie
Pinze tanglienti per laminectomia

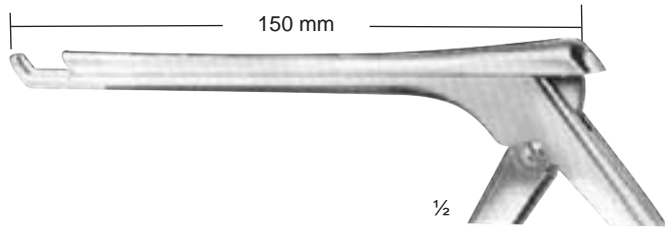

Colclough (Richter)
26-870-03
26-870-05

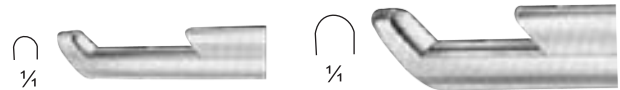

Length of shaft	150 mm 6"	200 mm 8"	150 mm 6"	200 mm 8"
Width of bite	3 mm	3 mm	5 mm	5 mm
Cat. Ref.	26-870-03	26-871-03	26-870-05	26-871-05

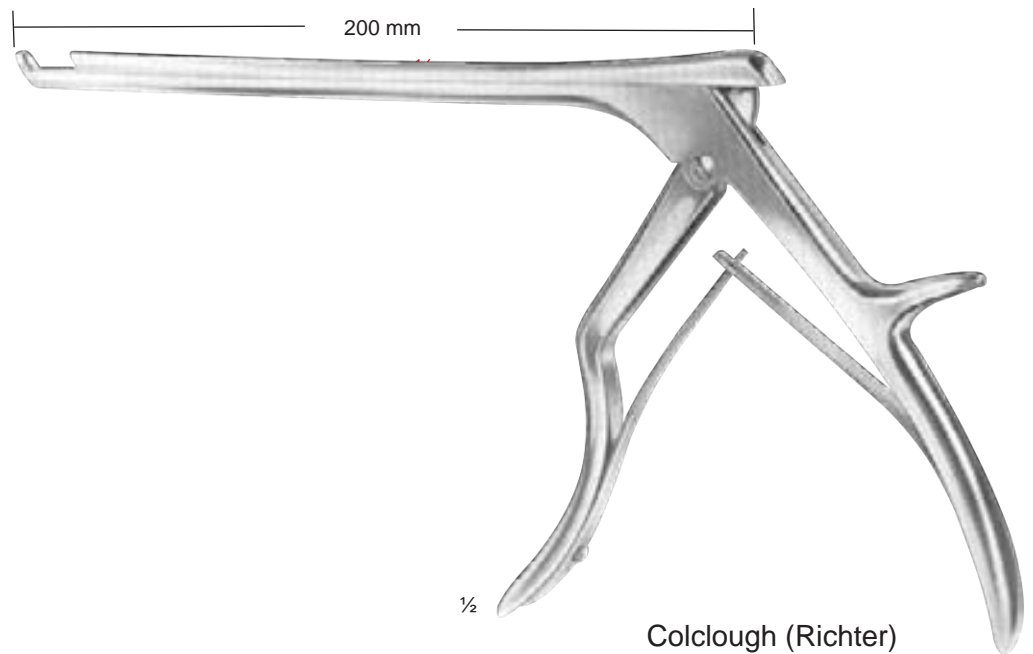

Colclough (Richter)
26-871-03
26-871-05

Laminectomy Punches

Laminektomiestanzen
Pinzas cortantes para laminectomía

Pinces emporte-pièces à laminectomie
Pinze tanglienti per laminectomia

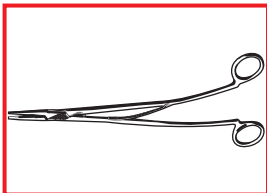

cutting upward

cutting downward

cutting 40° forward

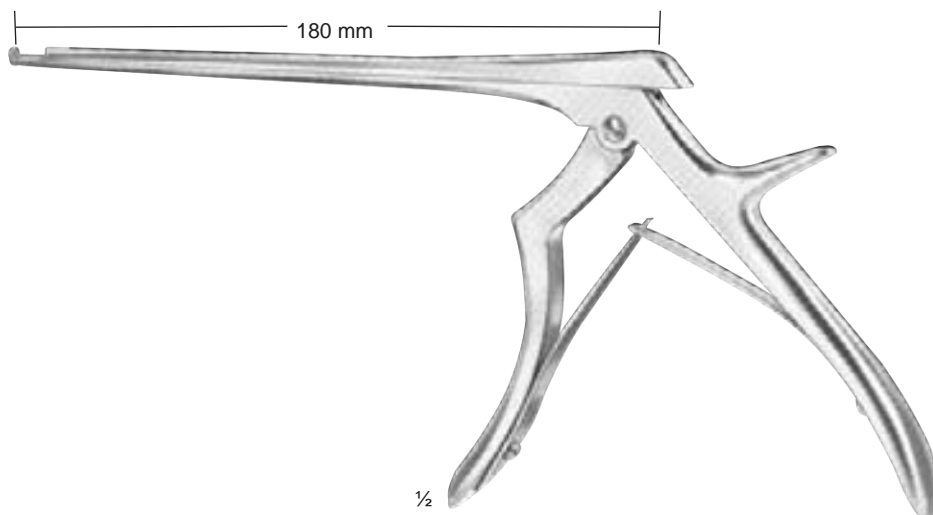
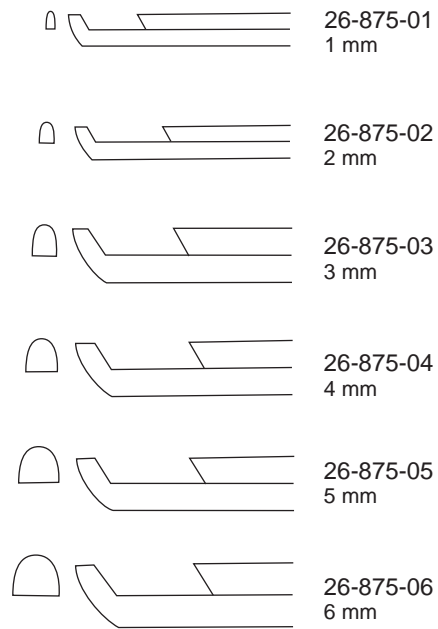
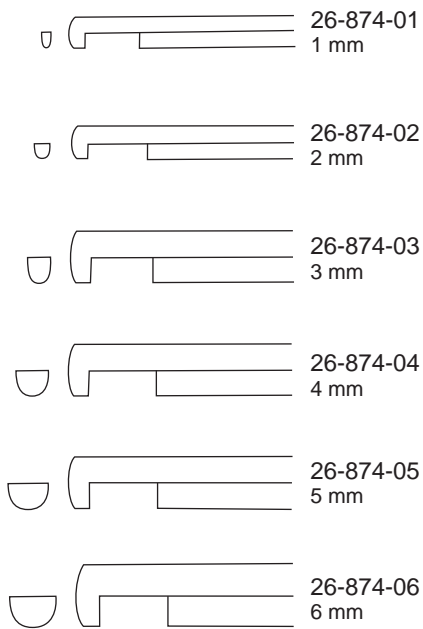
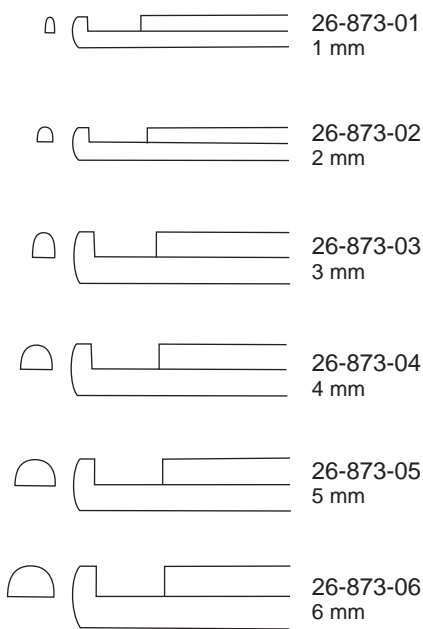

Ferris-Smith-Kerrison
26-873-01 - 26-875-06

Laminectomy Rongeurs

Laminektomieezangen
Pinzas para laminectomía

Pinces pour laminectomie
Pinze per laminectomia

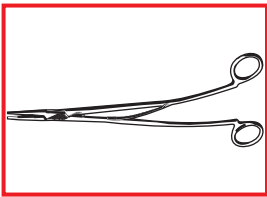

2mm

Cushing



2 x 10mm
26-878-01 = 120 mm
26-878-02 = 150 mm
26-878-03 = 180 mm

Cushing

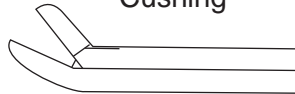

2 x 10mm/45°
26-879-01 = 120 mm
26-879-02 = 150 mm
26-879-03 = 180 mm

Cushing



2 x 10mm/45°
26-880-01 = 120 mm
26-880-02 = 150 mm
26-880-03 = 180 mm

3mm

Love-Gruenwald



3 x 10mm
26-878-04 = 120 mm
26-878-05 = 150 mm
26-878-06 = 180 mm

Love-Gruenwald

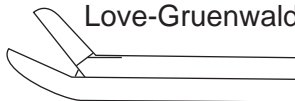

3 x 10mm/45°
26-879-04 = 120 mm
26-879-05 = 150 mm
26-879-06 = 180 mm

Love-Gruenwald

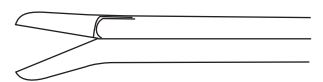

3 x 10mm/45°
26-880-04 = 120 mm
26-880-05 = 150 mm
26-880-06 = 180 mm

4mm

Spurling



4 x 10mm
26-878-07 = 120 mm
26-878-08 = 150 mm
26-878-09 = 180 mm

Spurling

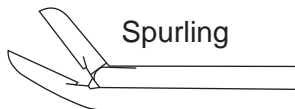

4 x 10mm/45°
26-879-07 = 120 mm
26-879-08 = 150 mm
26-879-09 = 180 mm

Spurling

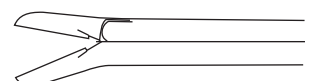

4 x 10mm/45°
26-880-07 = 120 mm
26-880-08 = 150 mm
26-880-09 = 180 mm

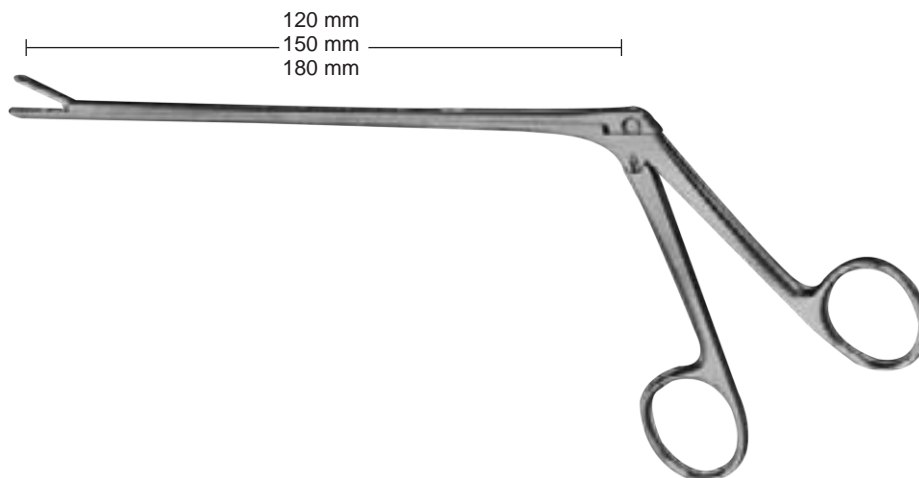

Laminectomy Rongeurs

Laminektomieezangen
Pinzas para laminectomía

Pinces pour laminectomie
Pinze per laminectomia

