

Falcon[®]

Surgical
Instruments



09

SPONGE FORCEPS

TUPFERZANGEN
PINZAS PARA POLIPOS
PINCES A PANSEMENTS
PINZE PER POLIPI





Polypus and Dressing Forceps, Sponge Holding Forceps

Korn- und Tupferzangen, Schwammzangen
Pinzas para pólipos, taponos y esponjas

Pinces à pansements, à tampons et à éponges
Pinze per polipi, tamponi e spugne



$\frac{1}{2}$
Ulrich
09-002-22 - 09-005-27

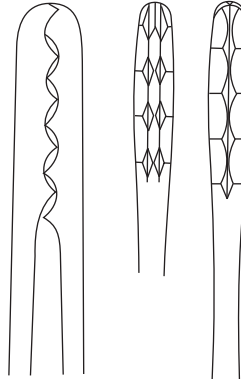

$\frac{1}{4}$
09-002-22
22 cm / 8 $\frac{3}{4}$ "

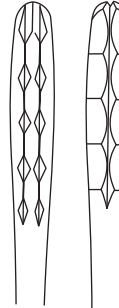

09-002-25
25 cm / 9 $\frac{3}{4}$ "

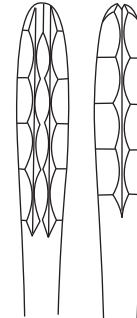

09-002-27
27 cm / 10 $\frac{3}{4}$ "

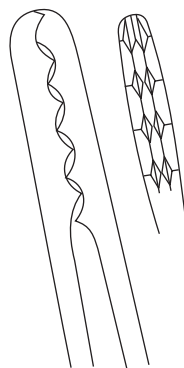

$\frac{1}{4}$
09-005-22
22 cm / 8 $\frac{3}{4}$ "

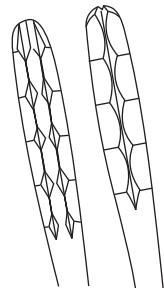

09-005-25
25 cm / 9 $\frac{3}{4}$ "

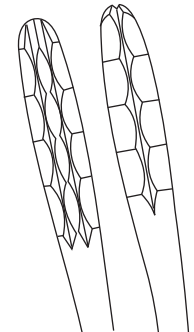

09-005-27
27 cm / 10 $\frac{3}{4}$ "



Polypus and Dressing Forceps, Sponge Holding Forceps

Korn- und Tupferzangen, Schwammzangen
Pinzas para pólipos, tapones y esponjas

Pinces à pansements, à tampons et à éponges
Pinze per polipi, tamponi e spugne

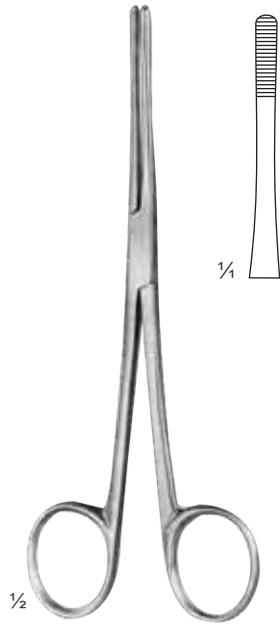

Lister
09-012-13 = 13 cm / 5"
09-012-16 = 16 cm / 6¼"
09-012-18 = 18 cm / 7"
09-012-20 = 20 cm / 8"

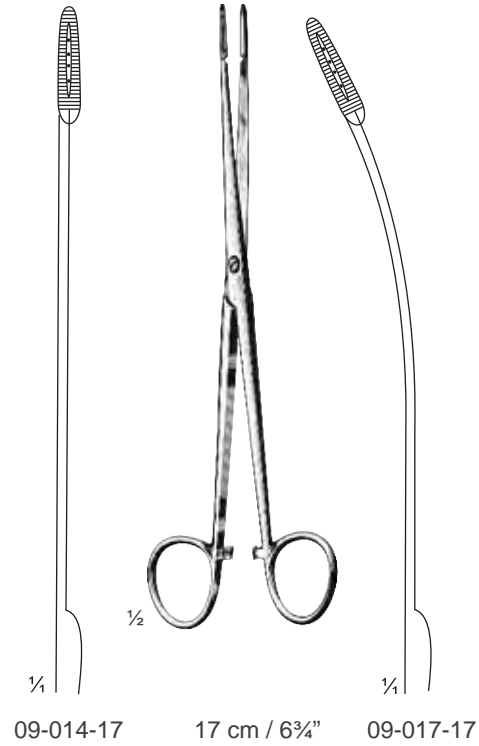

09-014-17 17 cm / 6¾" 09-017-17

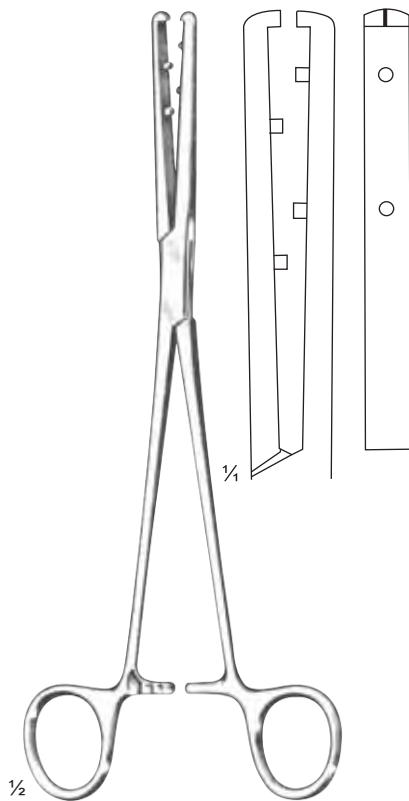

Emmet
09-019-21
21 cm / 8¼"

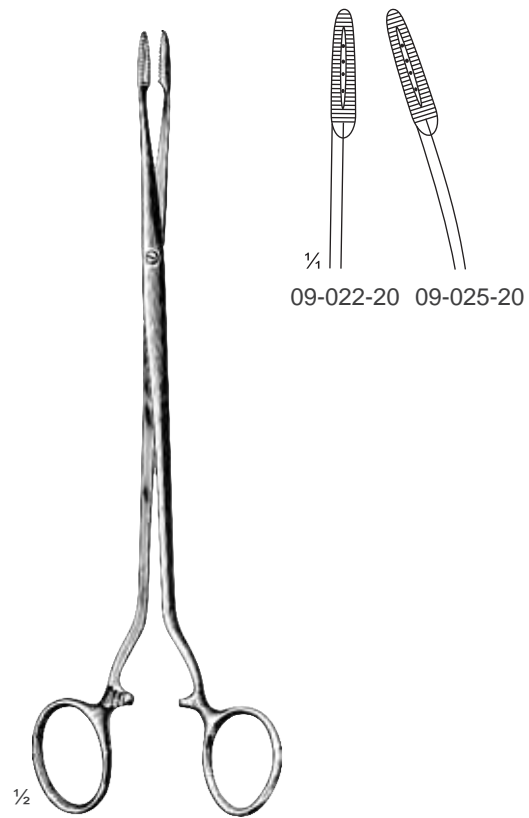

Duplay
09-022-20 - 09-025-20
20 cm / 8"



Polypus and Dressing Forceps, Sponge Holding Forceps

Korn- und Tupferzangen, Schwammzangen
Pinzas para pólipos, tapones y esponjas

Pinces à pansements, à tampons et à éponges
Pinze per polipi, tamponi e spugne

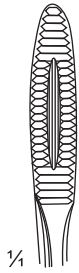

1/4

- 09-030-20 = 20 cm / 8"
- 09-030-22 = 22 cm / 8 3/4"
- 09-030-25 = 25 cm / 9 3/4"
- 09-030-27 = 27 cm / 10 3/4"

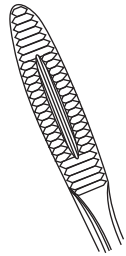

- 09-033-20 = 20 cm / 8" = 09-036-20
- 09-033-22 = 22 cm / 8 3/4" = 09-036-22
- 09-033-25 = 25 cm / 9 3/4" = 09-036-25
- 09-033-27 = 27 cm / 10 3/4" = 09-036-27

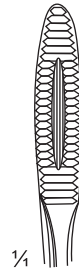

1/4

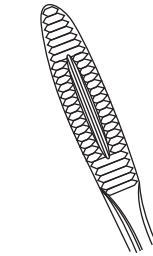

- 09-039-20 = 20 cm / 8"
- 09-039-22 = 22 cm / 8 3/4"
- 09-039-25 = 25 cm / 9 3/4"
- 09-039-27 = 27 cm / 10 3/4"

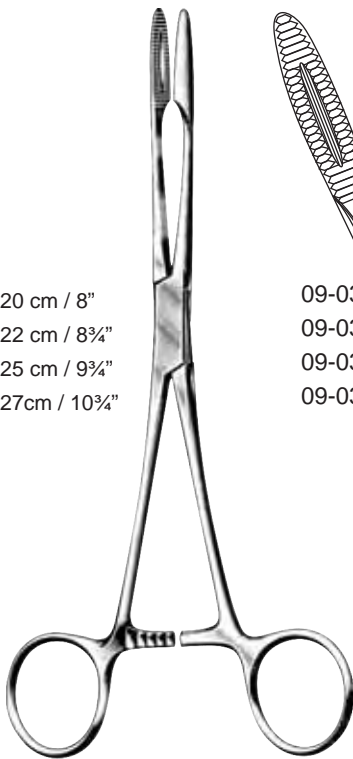

Gross-Maier
09-030-20 - 09-033-27



Gross-Maier
09-036-20 - 09-039-27

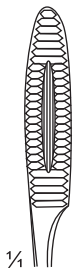

1/4

- 09-042-20 = 20 cm / 8"
- 09-042-25 = 25 cm / 9 3/4"

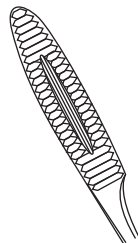

- 09-045-20 = 20 cm / 8"
- 09-045-25 = 25 cm / 9 3/4"

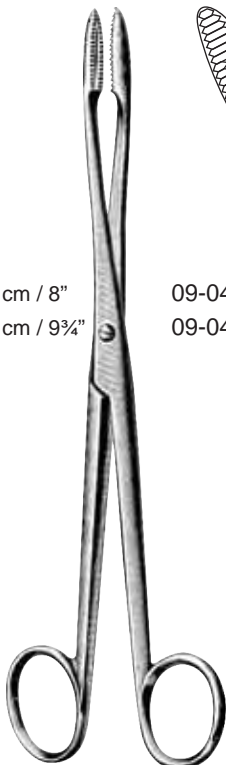

Gross-Maier
09-042-20 - 09-045-25

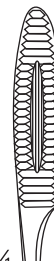

1/4

- 09-048-20 = 20 cm / 8"
- 09-048-25 = 25 cm / 9 3/4"

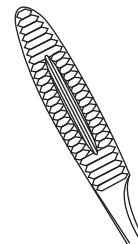

- 09-051-20 = 20 cm / 8"
- 09-051-25 = 25 cm / 9 3/4"

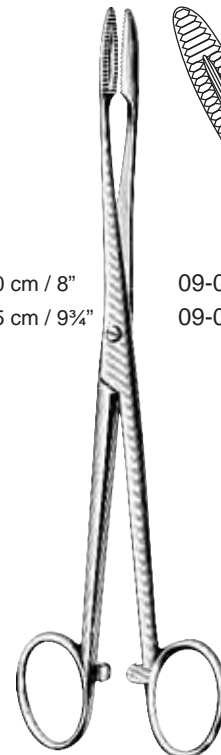

Gross-Maier
09-048-20 - 09-051-25



Polypus and Dressing Forceps, Sponge Holding Forceps

Korn- und Tupferzangen, Schwammzangen
Pinzas para pólipos, tapones y esponjas

Pinces à pansements, à tampons et à éponges
Pinze per polipi, tamponi e spugne

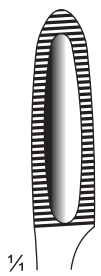

1/4

09-058-28

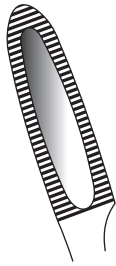

09-061-28



1/4



1/2

09-067-25



09-070-25



09-071-25



1/4

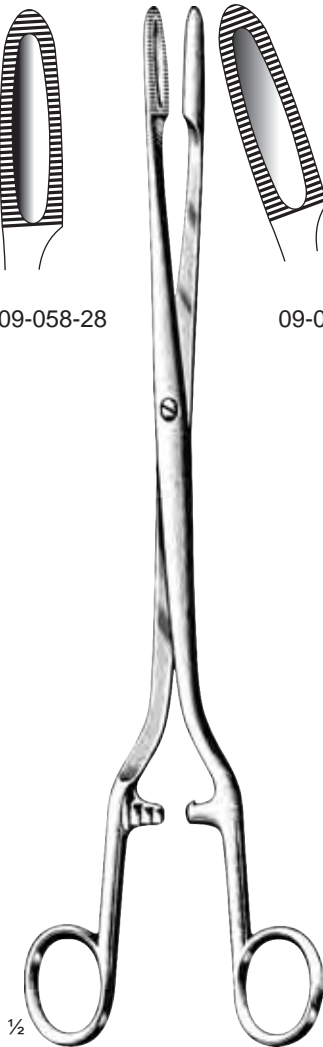

1/2

Sims-Maier
09-058-28 - 09-061-28
28 cm / 11"

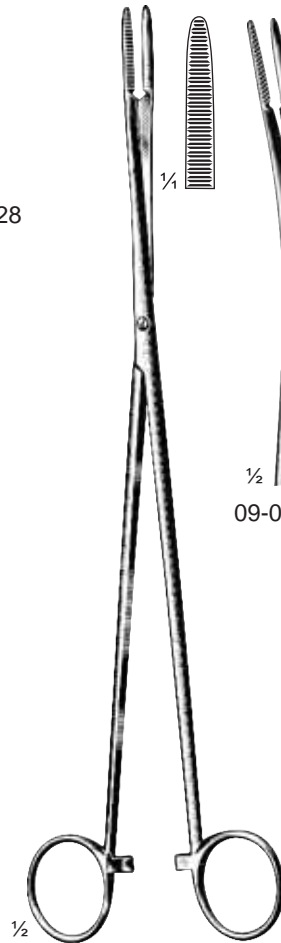

1/2

Pelkmann
09-064-25
25 cm / 9 3/4"



1/2

Maier/Walton
09-070-25 - 09-071-25
25 cm / 9 3/4"

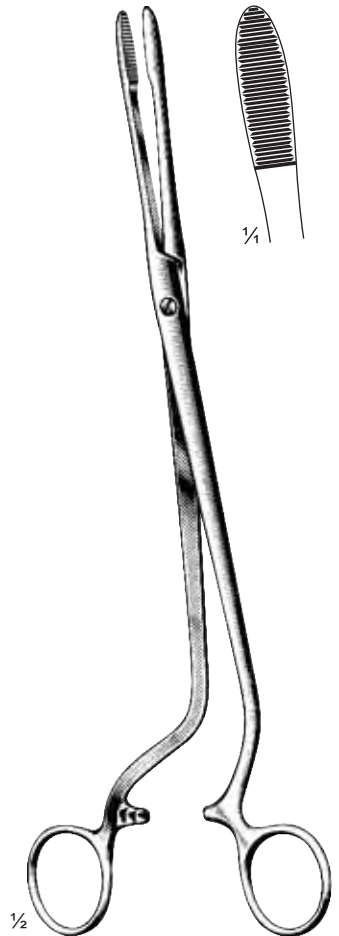

1/2

Cheron
09-078-25
25 cm / 9 3/4"



Polypus and Dressing Forceps, Sponge Holding Forceps

Korn- und Tupferzangen, Schwammzangen
 Pinzas para pólipos, tapones y esponjas

Pinces à pansements, à tampons et à éponges
 Pinze per polipi, tamponi e spugne



Fletcher
 09-080-24
 24 cm / 9½"

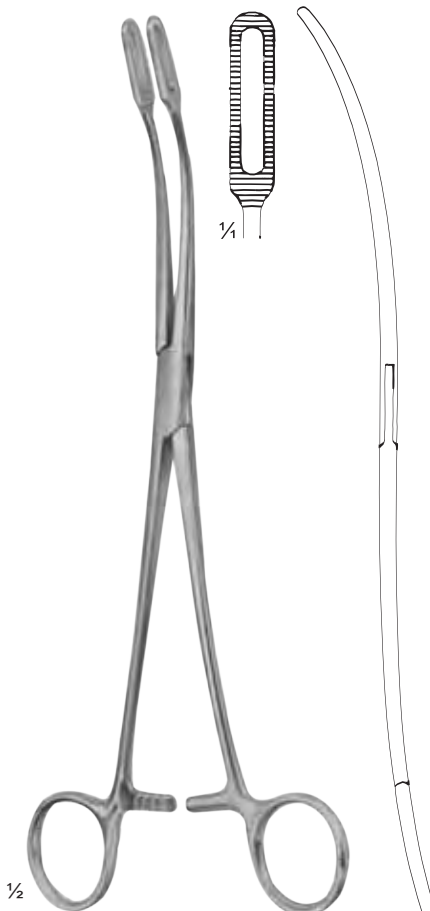

Fletcher
 09-083-24
 24 cm / 9½"

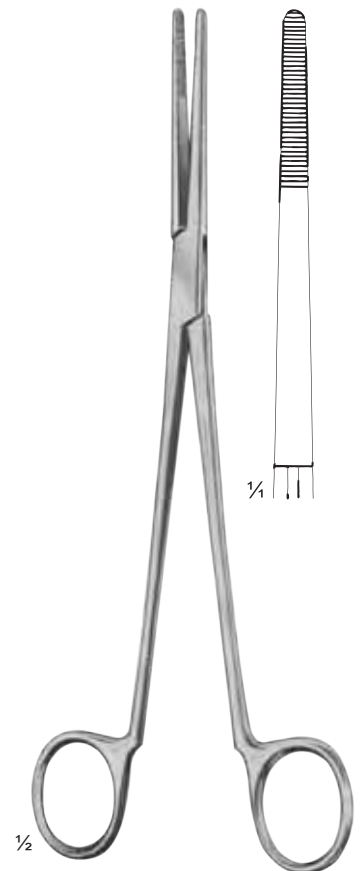

Westermark
 09-086-23
 23 cm / 9"



Polypus and Dressing Forceps, Sponge Holding Forceps

Korn- und Tupferzangen, Schwammzangen
Pinzas para pólipos, tapones y esponjas

Pinces à pansements, à tampons et à éponges
Pinze per polipi, tamponi e spugne

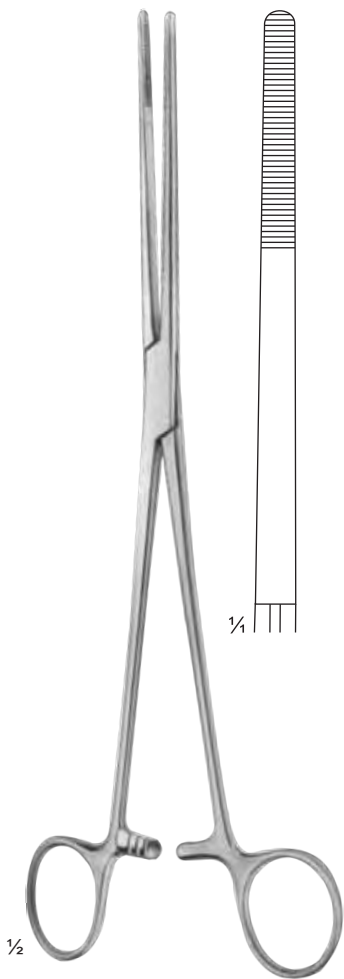

Bozemann
09-092-26
26 cm / 10 1/4"

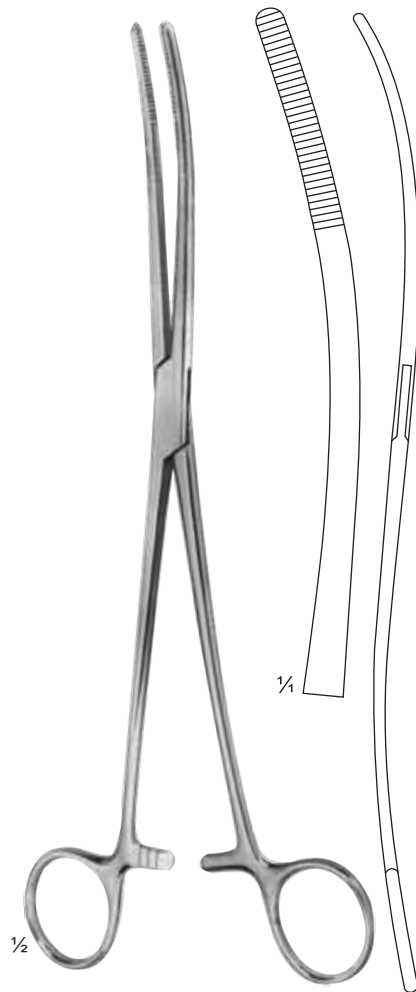

Bozemann
09-095-26
26 cm / 10 1/4"

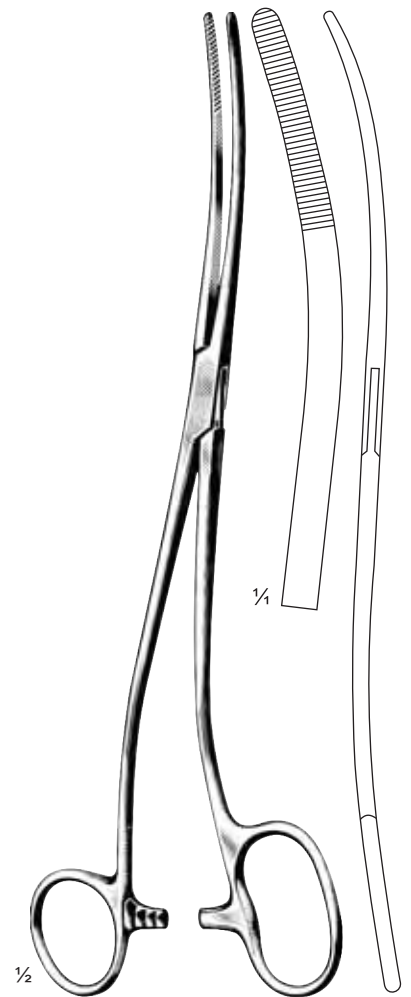

Bozemann-Douglas
09-097-26
26 cm / 10 1/4"



Polypus and Dressing Forceps, Sponge Holding Forceps

Korn- und Tupferzangen, Schwammzangen
 Pinzas para pólipos, tapones y esponjas

Pinces à pansements, à tampons et à éponges
 Pinze per polipi, tamponi e spugne

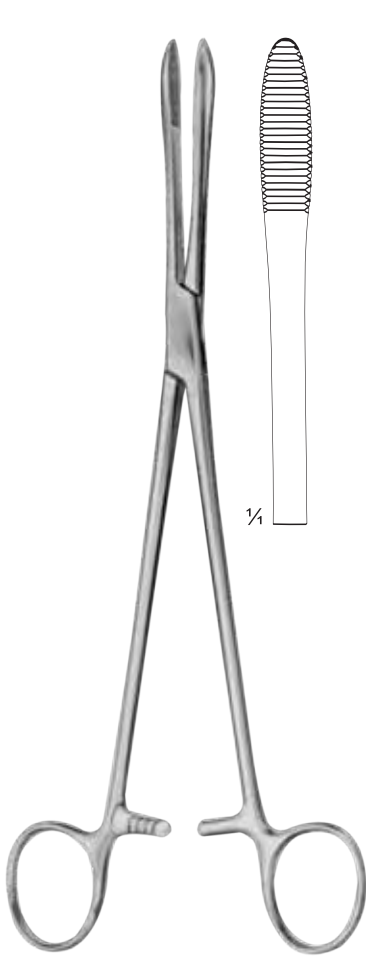

Collin
 09-102-24
 24 cm / 9½"

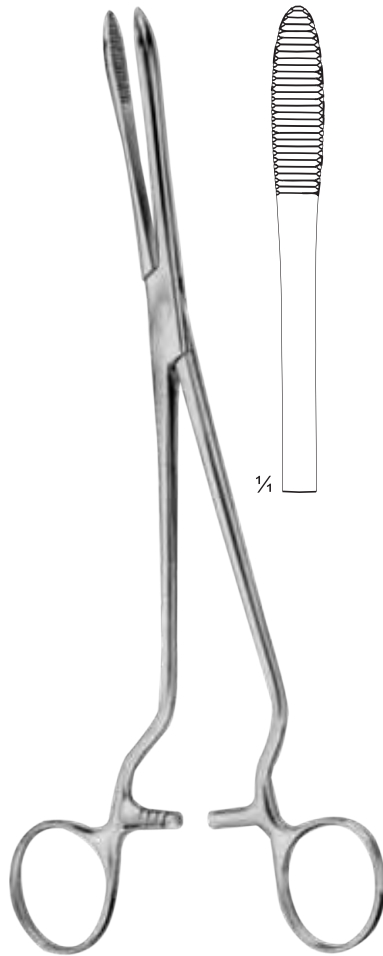

Cheron
 09-105-24
 24 cm / 9½"

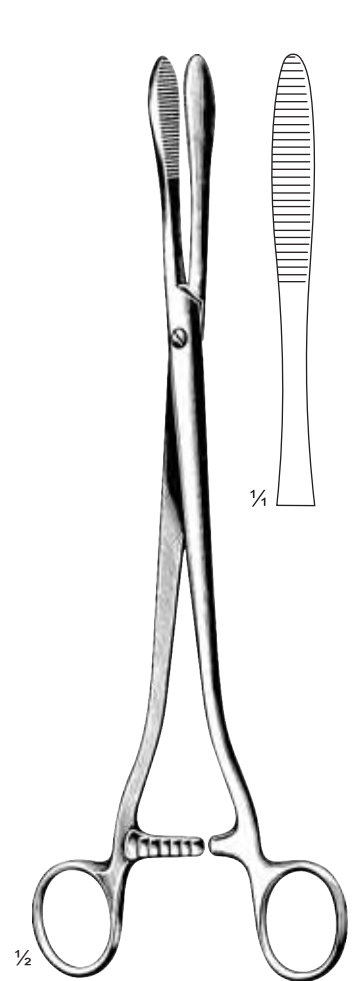

Collin
 09-108-25
 25 cm / 9¾"



Polypus and Dressing Forceps, Sponge Holding Forceps

Korn- und Tupferzangen, Schwammzangen
Pinzas para pólipos, tapones y esponjas

Pinces à pansements, à tampons et à éponges
Pinze per polipi, tamponi e spugne

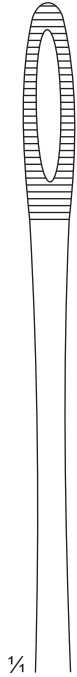

1/4

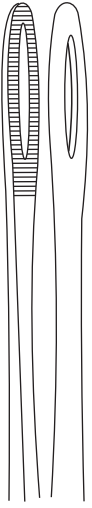

09-114-25

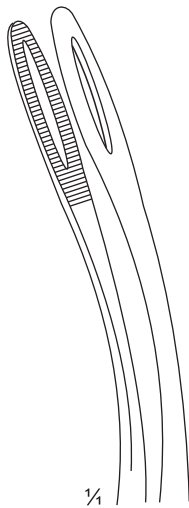

1/4

09-117-25

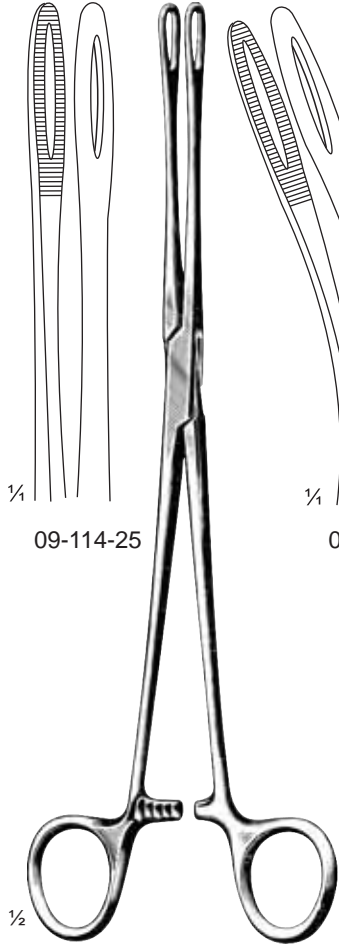

1/2

Foerster
25 cm / 9 3/4"
narrow



1/2

Rampley
09-120-25
25 cm / 9 3/4"

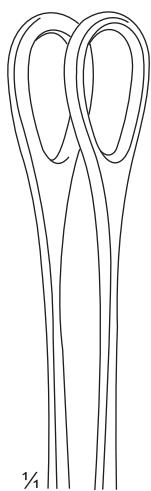

1/4

09-122-25
25 cm / 9 3/4"

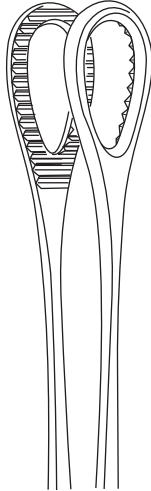

09-124-18 = 18 cm / 7"
09-124-20 = 20 cm / 8"
09-124-25 = 25 cm / 9 3/4"



1/2

Foerster-Ballenger
09-122-25 09-129-25

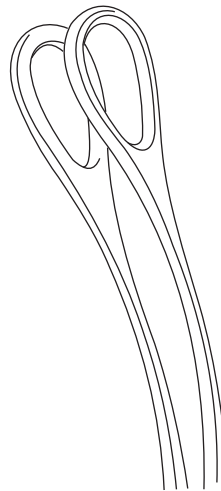

09-127-25
25 cm / 9 3/4"

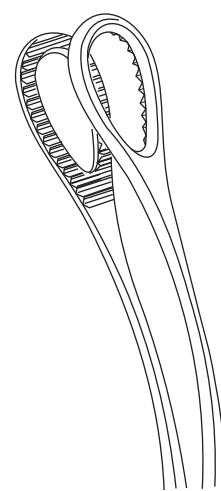

09-129-18 = 18 cm / 7"
09-129-20 = 20 cm / 8"
09-129-25 = 25 cm / 9 3/4"



Polypus and Dressing Forceps, Sponge Holding Forceps

Korn- und Tupferzangen, Schwammzangen
Pinzas para pólipos, tapones y esponjas

Pinces à pansements, à tampons et à éponges
Pinze per polipi, tamponi e spugne



Rampley
09-135-18 = 18 cm / 7"
09-135-24 = 24 cm / 9½"



09-135-18
18 cm / 7"

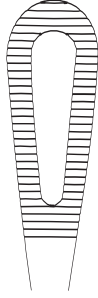

09-135-24
24 cm / 9½"



09-138-18
18 cm / 7"

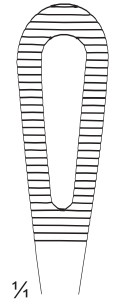

09-138-24
24 cm / 9½"



09-138-20
20 cm / 8"

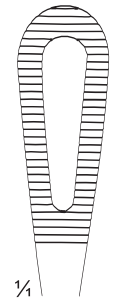

09-138-25
25 cm / 9¾"

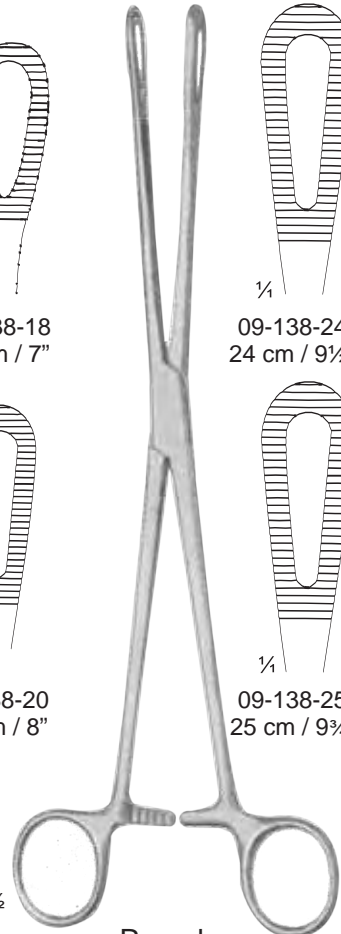

Rampley
09-138-18 - 09-138-25

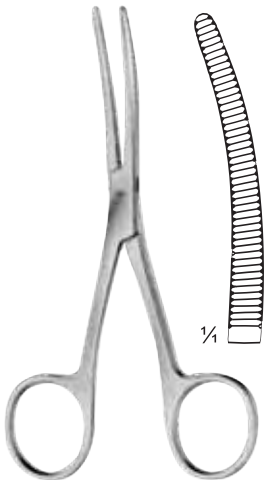

Bryant
09-141-13 = 13 cm / 5"
09-141-15 = 15 cm / 6"



¼

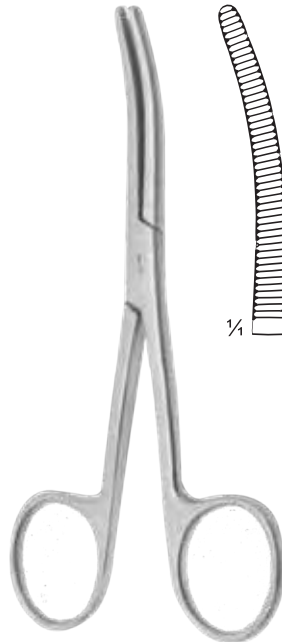

Bryant
09-143-13 = 13 cm / 5"
09-143-15 = 15 cm / 6"



¼



Collin
09-146-23
23 cm / 9"

Bullet Forceps

