

**Falcon**<sup>®</sup>

Surgical  
Instruments



24

BONE SURGERY

KNOCHENCHIRURGIE  
CIRUGÍA ÓSEA  
CHIRURGIE OSSEUSE  
CHIRURGIA OSSEA







### Amputation Saws

Amputationssägen  
Sierras de amputación

Scies à amputation  
Seghe per amputazione



¼

**Satterlee**  
24-002-31  
31 cm / 12¼"



**Charriere**  
24-004-27 = 27 cm / 10½"  
24-004-30 = 30 cm / 12"



⅓

**Langenbeck**  
24-006-23  
23 cm / 9"



⅓

**Lindemann**  
24-008-20  
20 cm / 8"

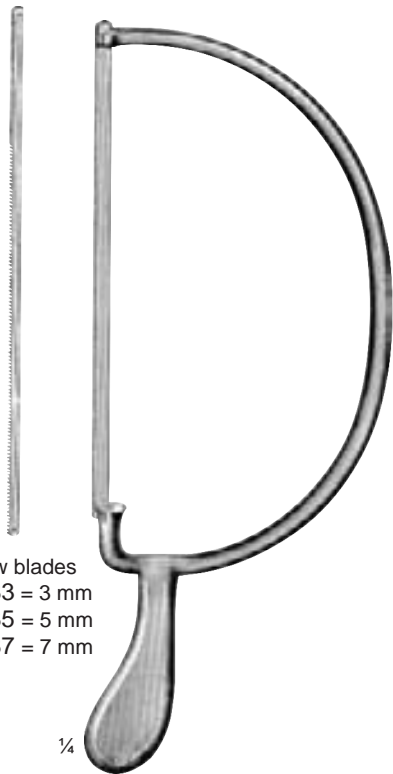

Spare saw blades  
24-011-83 = 3 mm  
24-011-85 = 5 mm  
24-011-87 = 7 mm

¼

**Helferich-Bier**  
24-011-39  
39 cm / 15½"

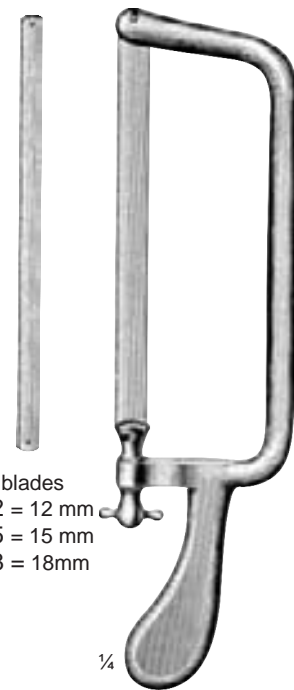

Spare saw blades  
24-013-92 = 12 mm  
24-013-95 = 15 mm  
24-013-98 = 18mm

¼

**Charriere**  
24-013-35  
35 cm / 14"



### Reamers, Hand Drills

Reibahlen, Handbohrapparates  
Escariadores, Perforadores de mano

Pointes-carrées, Perforateurs à main  
Punteruoli, Perforatori a mano



Perthes  
24-024-21  
21 cm / 8¼"



24-026-14  
14 cm / 5½"



Adson  
24-029-15  
15 cm / 6"

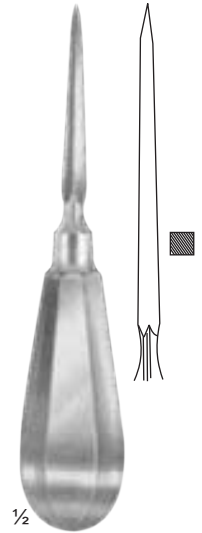

24-032-14  
14 cm / 5½"

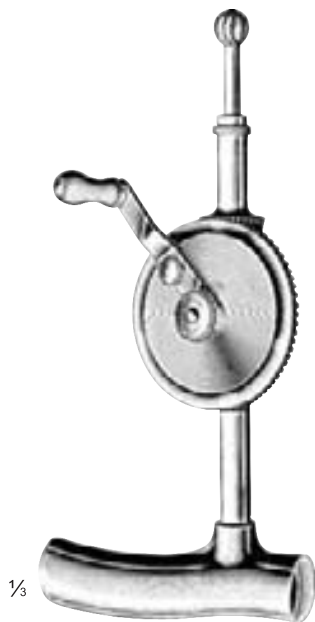

Stille  
24-037-00  
20 cm / 8"

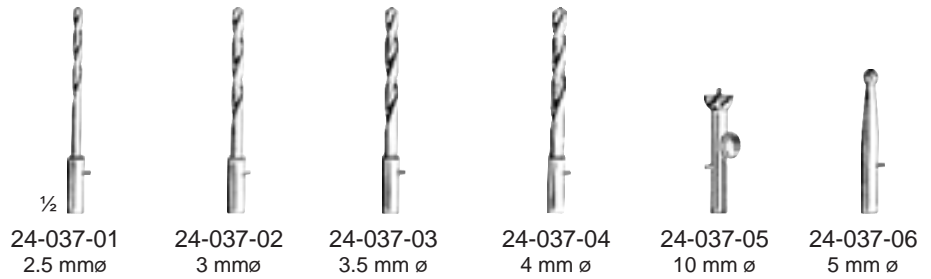

24-037-01 2.5 mmø  
24-037-02 3 mmø  
24-037-03 3.5 mmø  
24-037-04 4 mmø  
24-037-05 10 mmø  
24-037-06 5 mmø



24-037-07 8 mmø  
24-037-08 12 mmø  
24-037-09 16 mmø  
24-037-10 1 mmø  
24-037-11 1.5 mmø  
24-037-12 2 mmø



**Hand Drills**

Handbohrapparate  
Perforadores de mano

Perforateurs à main  
Perforatori a mano



**Stille-Sherman**  
24-047-00  
24 cm / 9½"



24-047-01  
2.5 mm ø



24-047-02  
3.0 mm ø



24-047-03  
3.5 mm ø



24-050-09  
Extension Rod



24-050-01  
9 mm ø



24-050-02  
14 mm ø



24-050-03  
16 mm ø



24-050-04  
22 mm ø



**Hudson**  
24-050-00  
27 cm / 10½"



24-050-05  
Cushing  
14 mm ø



24-050-06  
2 mm ø



24-050-07  
McKenzie  
13 mm ø



24-050-08  
Errico  
16 mm ø



**Hand Drills**

Handbohrapparate  
Perforadores de mano

Perforateurs à main  
Perforatori a mano



1/8

Universal  
24-058-00



1/8

Moore  
24-060-00

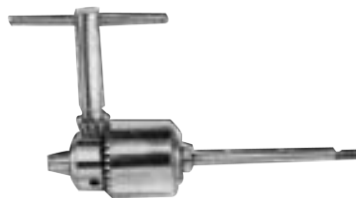
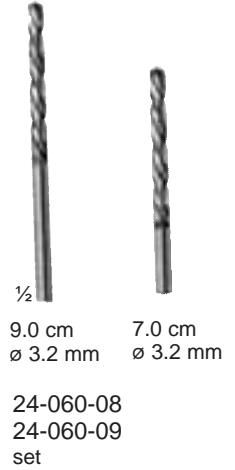

24-062-06 = 6.35 mm / 1/4"



### Osteosynthesis Instruments

Instrumente zur Osteosynthese  
Instrumentos p. osteosíntesis

Instruments p. ostéosynthèse  
Strumenti per osteosintesi



1/2

Lane  
24-072-18  
18 cm / 7 1/4"  
Plate Bender

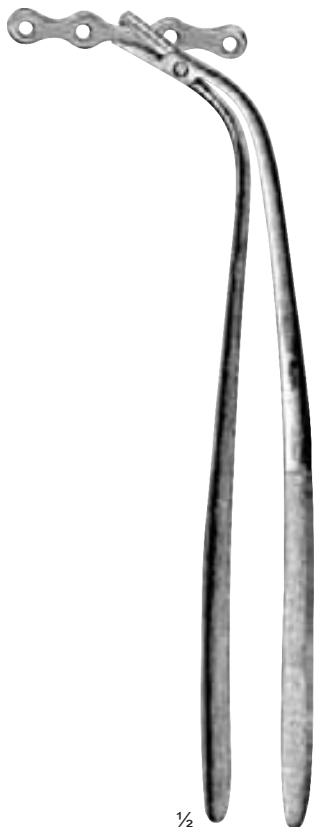

1/2

Lane  
24-075-22  
22 cm / 8 3/4"  
Plate Holding Forceps

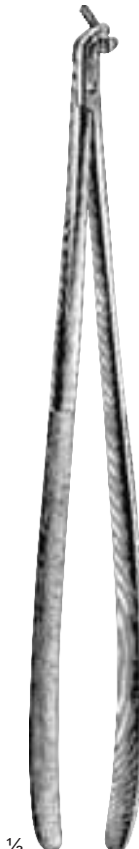

1/2

Lane  
24-077-23  
23 cm / 9"  
Screw Holding Forceps



1/2

Lane  
24-079-18  
18 cm / 7"  
Screw Holding Forceps



**Screwdrivers**

Schraubendreher  
Destornilladores

Tournevis  
Giraviti



1/2  
24-086-25  
2.5 mm  
24-086-35  
3.5 mm



1/2  
24-088-17  
17 cm / 6 3/4"



1/2  
Lane  
24-090-25  
25 cm / 10"



1/2  
Lane  
24-092-25  
25 cm / 10"



1/2  
Phillips  
24-094-25  
25 cm / 10"



1/2  
Williams  
24-096-24 -  
24-097-24  
24 cm / 9 1/2"





**Screwdrivers**

Schraubendreher  
Destornilladores

Tournevis  
Giraviti



2.5mm



3.5mm



1/2

Lane  
24-104-25  
25 cm / 10"



Lane  
24-106-25  
25 cm / 10"



Philips  
24-108-25  
25 cm / 10"



24-110-25  
25 cm / 10"



24-112-25  
25 cm / 10"



24-114-17  
17 cm / 6 3/4"



**Screwdrivers**

Schraubendreher  
Destornilladores

Tournevis  
Giraviti



Screwdriver set in case  
Sterilizing Case only

24-120-00  
24-120-01



1/2

24-120-02  
14.5 cm / 5 1/2"



1/4

24-120-03



1/4

24-120-06



1/4

24-120-09



1/4

24-120-10



1/4

24-120-13



1/4

24-120-35  
3.5 mm



1/4

24-120-25  
2.5 mm

**Bone Holding Clamps, Traction Bar**

Knochenhalteklammern, Distractionsklammer  
 Grapas porta-huesos, Barra de tracción

Daviers à os, Ecarteurs pour les daviers à os  
 Tenaglia per ossa, Divaricatore per le tenaglie per ossa



Gerster-Lowman  
 24-127-13 - 24-127-22

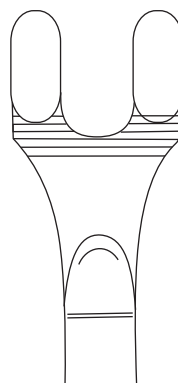
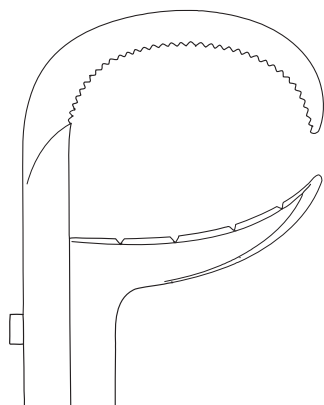

24-127-13  
 13 cm / 5"

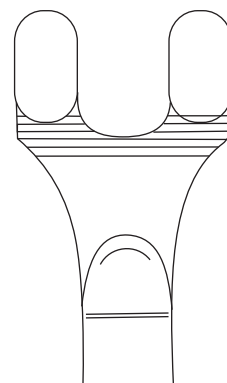

24-127-18  
 18 cm / 7"

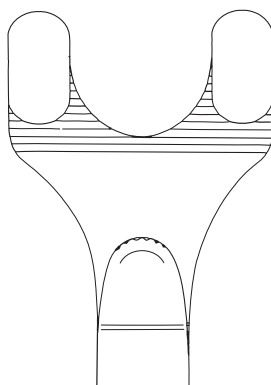

24-127-20  
 20 cm / 8"

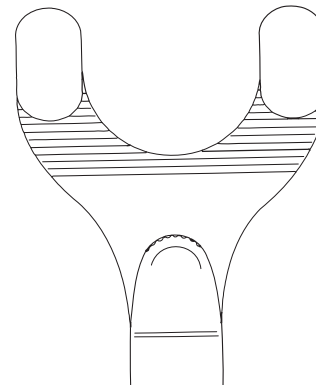

24-127-22  
 22 cm / 8¾"

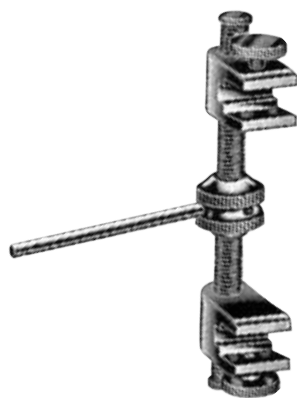

Gerster  
 24-129-15  
 15 cm / 6"



Lowman-Baby  
 24-132-13  
 13 cm / 5"



Lowman-Hoglund  
 24-134-18  
 18 cm / 7"



**Wire Twisting Forceps**

Drahtwirbelzangen  
Pinzas para torcer alambre

Pinces à torsader le fil  
Pinze per ritorcere fili

TC Lined  
Mit TC-Einsätzen  
Con bocas TC  
A mors TC  
Con morso TC

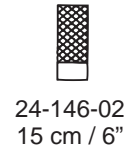
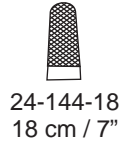
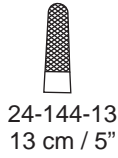



**Flat Nose Pliers, Vise Grip, Combi-Flat Nose Plier**

Flachzangen, Tonnenzange, Kombinationszange  
 Alicates de pico plano, Combi-Alicate de alambre

Pinces plates, Combi-Pince pour fils  
 Tenaglie piatte, Combi-Pinza per fili



24-157-17  
 17 cm / 6½"

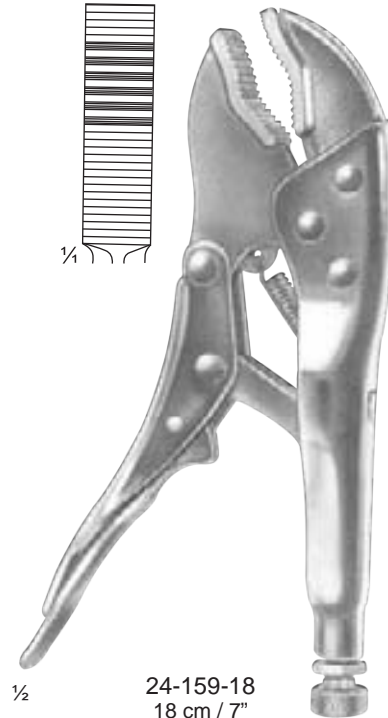

24-159-18  
 18 cm / 7"

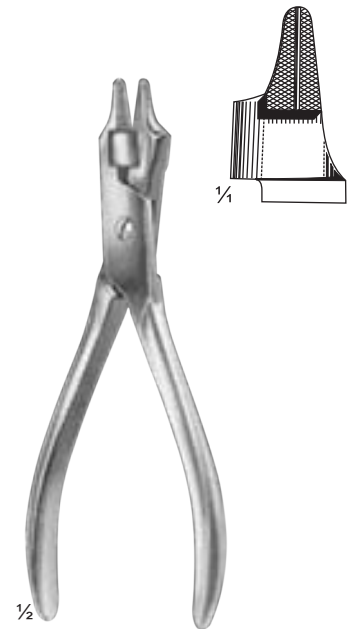

24-162-15  
 15 cm / 6"

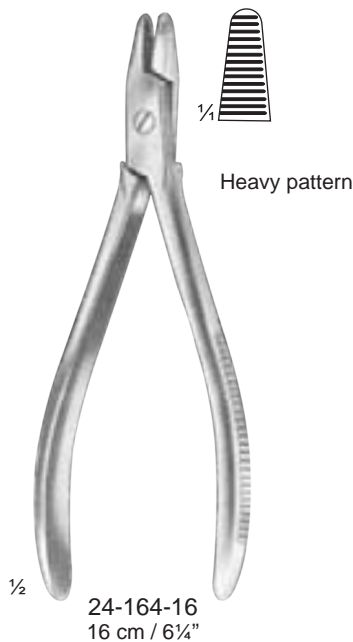

24-164-16  
 16 cm / 6¼"



24-166-17  
 16.5 cm / 6½"



### Combi-Flat Nose Plier, Flat Nose Pliers

Kombinationszange, Flachzangen

Combi-Pince pour fils, Pinces plates

Combi-Alicate de alambre, Alicates de pico plano

Combi-Pinza per fili ,Tenaglie piatte

TC Lined  
Mit TC-Einsätzen  
Con bocas TC  
A mors TC  
Con morso TC

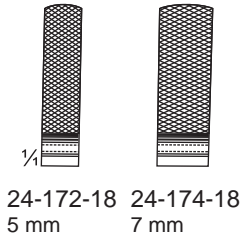

24-172-18 - 24-174-18  
18 cm / 7"

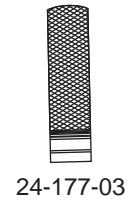
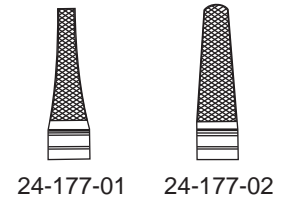

24-177-01 - 24-177-03  
18 cm / 7"

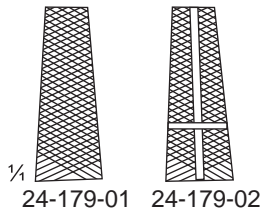

24-179-01 - 24-179-02  
17 cm / 6 3/4"

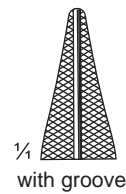

24-182-16  
16 cm / 6 1/4"

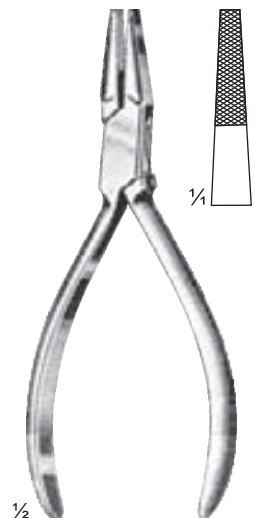

24-184-14  
14 cm / 5 1/2"



### Wire Cutting Pliers

Drahtkneifzangen, Seitenschneider

Pinces à couper le fil, Pinces coupantes de côté

Alicates para cortar alambre, Tenazas de corte lateral

Tenaglie tagliafilì, Tenaglie tagliafilì laterali

TC Lined  
Mit TC-Einsätzen  
Con bocas TC  
A mors TC  
Con morso TC



1/2

**Diamant**  
24-192-16  
16 cm / 6 1/4"



1/2

24-194-16  
16 cm / 6 1/4"



1/2

24-196-15  
15 cm / 6"



1/2

24-199-24  
24 cm / 9 1/2"

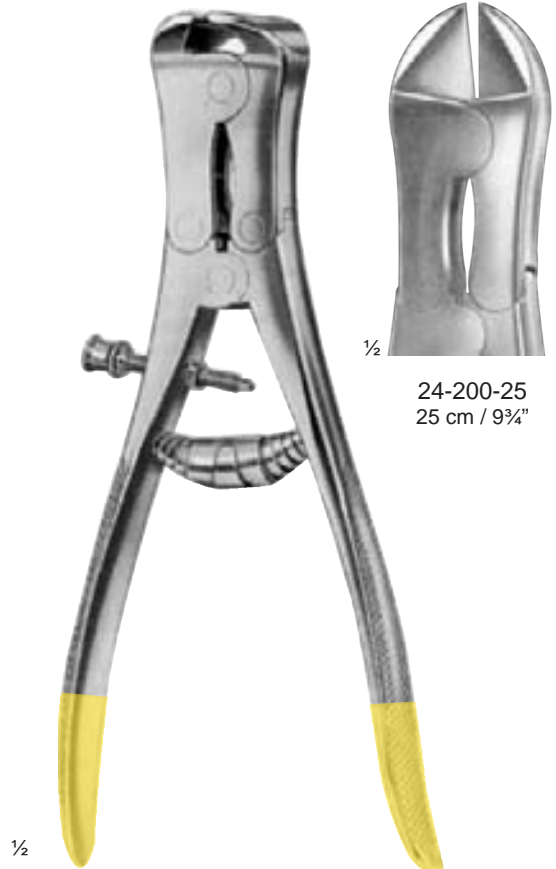

1/2

24-200-23  
23 cm / 9"



1/2

24-200-25  
25 cm / 9 3/4"



### Wire Cutting Pliers

Drahtkneifzangen, Seitenschneider

Pinces à couper le fil, Pinces coupantes de côté

Alicates para cortar alambre, Tenazas de corte lateral

Tenaglie tagliafilì, Tenaglie tagliafilì laterali

TC Lined  
Mit TC-Einsätzen  
Con bocas TC  
A mors TC  
Con morso TC



24-207-16  
16 cm / 6¼"  
24-207-18  
18 cm / 7"

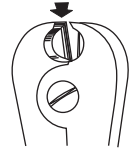

for soft Wires

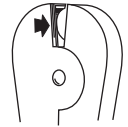

for hard wires  
up to 2.5 mm ø

½

24-210-18  
18 cm / 7"



½

24-213-22  
22 cm / 8¾"



24-214-47  
47 cm / 18½"



24-215-47  
47 cm / 18½"





**Bone Wire, Wire Guides, Wire Tightener**

Stahldraht, Drahtumführungsadeln, Drahtspanner  
 Alambre para hueso, Agujas pasa-hilo, Tensor cierra-hilo

Fil à os, Aiguilles passe-fils, Tendeur serre-fil  
 Filo per ossa, Aghi Passafili, Strumento tendifili



1/3

**Demel**  
 24-219-01 - 24-219-03

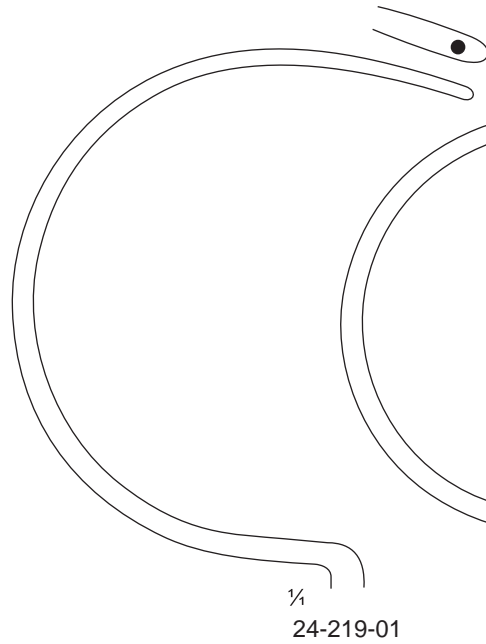

1/4  
 24-219-01

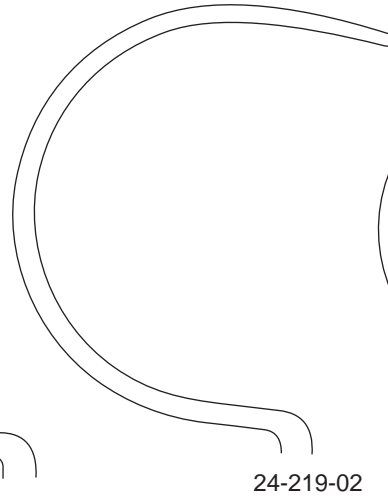

24-219-02

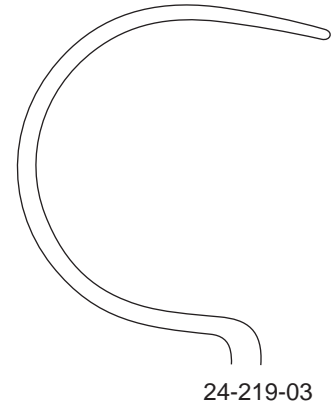

24-219-03

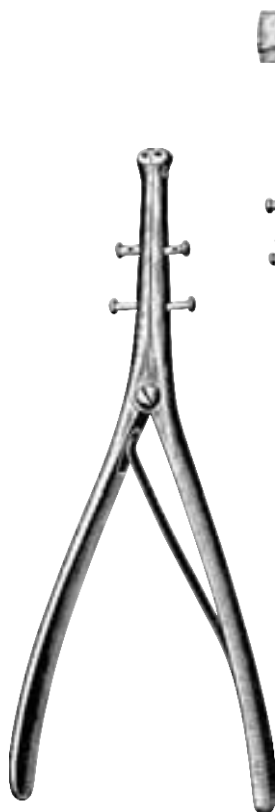

1/3

**Demel**  
 24-226-28  
 28 cm / 11"

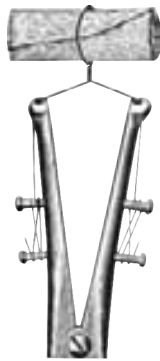

1/2

**Loute**  
 24-228-21  
 21 cm / 8 1/4"



### Instruments for Küntscher Nails

Instrumentarium für Küntscher - Nägel  
Instrumentos para clavos Küntscher

Instrumentation pour les clous de Küntscher  
Strumenti per chiodi Küntscher

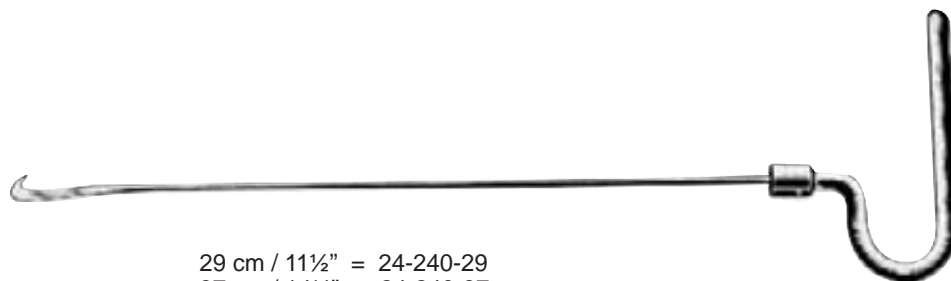
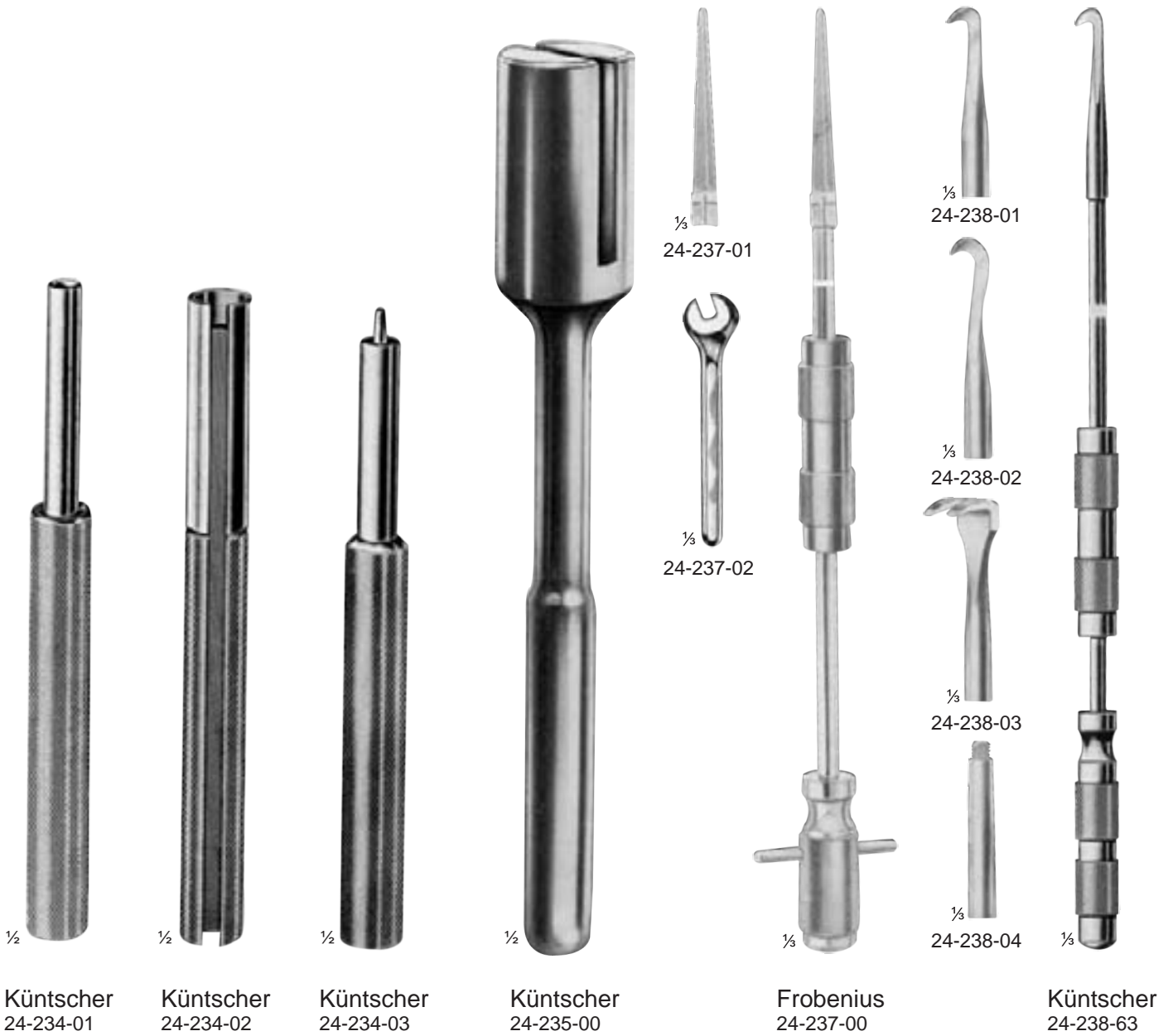

29 cm / 11½" = 24-240-29  
 37 cm / 14½" = 24-240-37  
 42 cm / 16½" = 24-240-42  
 49 cm / 19¼" = 24-240-49

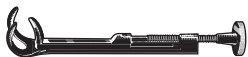

**Extension Pins, Extension Bows**

Extensionsnägel, Extensionsbügel  
Clavos de extensión, Estribos para extensión

Clous à os, Etriers à extension  
Chiodi per ossa, Archi per estensione

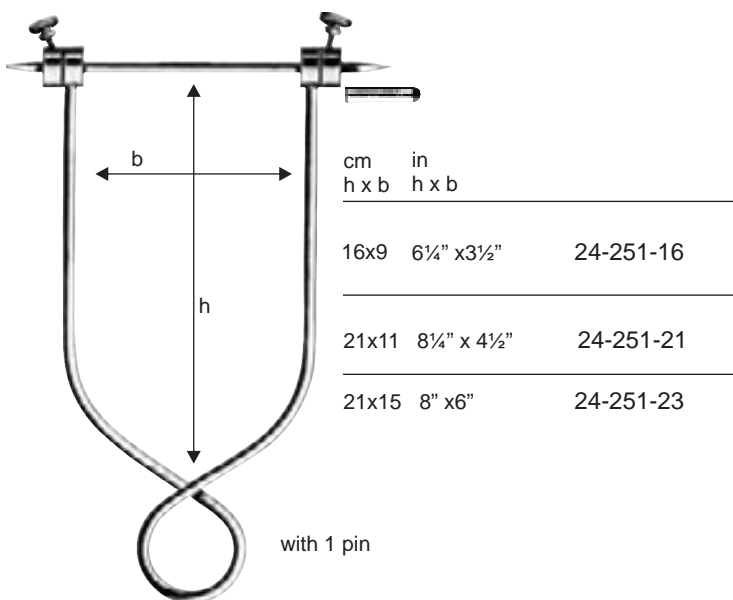

Bohler

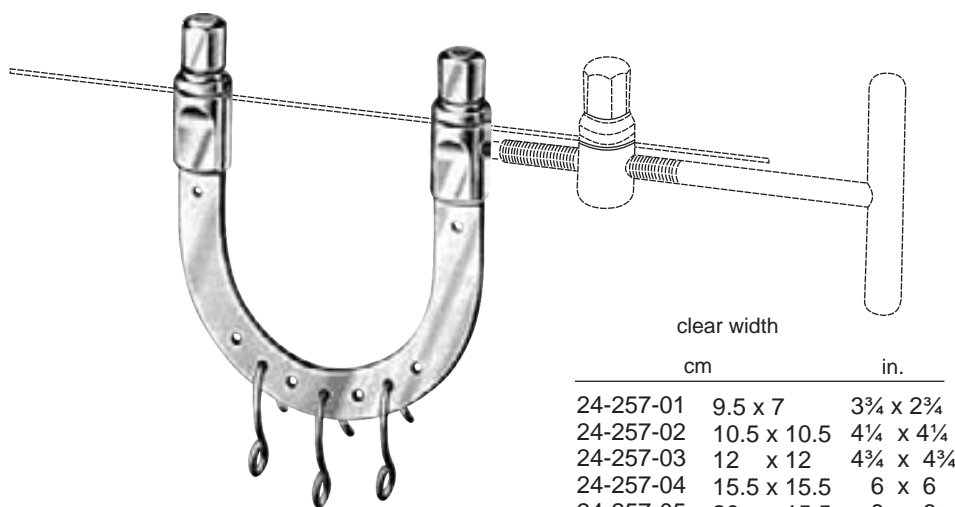

Kirschner  
24-257-01 - 24-257-05

With 3 Traction hooks.



**Extension Bows**

Extensionsbügel  
Estribos para extensión

Etriers à extension  
Archi per estensione

with 3 traction hooks

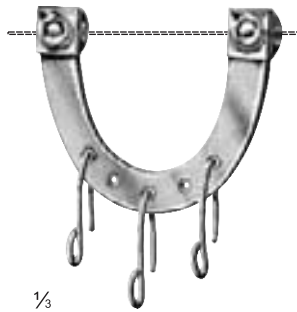

1/3

**Kirschner**  
24-263-01  
6 x 5 cm / 2 1/2 x 2"

with 3 traction hooks



1/3

**Kirschner**  
24-265-01 - 24-265-02

24-265-01  
18.5 cm / 7 1/4"  
0-40 mm

24-265-02  
26.5 cm / 10 1/2"  
35-200 mm

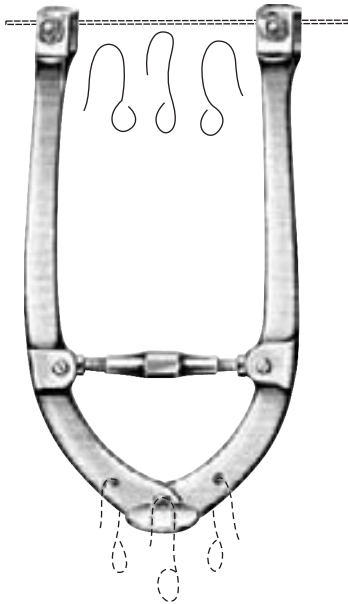

24-267-18 - 24-267-27

clear width

cm in.

24-267-18 18 x 10 7 x 4  
24-267-27 27 x 16 10 1/2 x 6 1/4

1/4



24-270-18



24-273-19  
19 cm / 7 1/2"



1/2

24-275-03



1/2

24-275-06



### Hand Drills

Handbohrapparate  
Perforadores de mano

Perforateurs à main  
Perforatori a mano

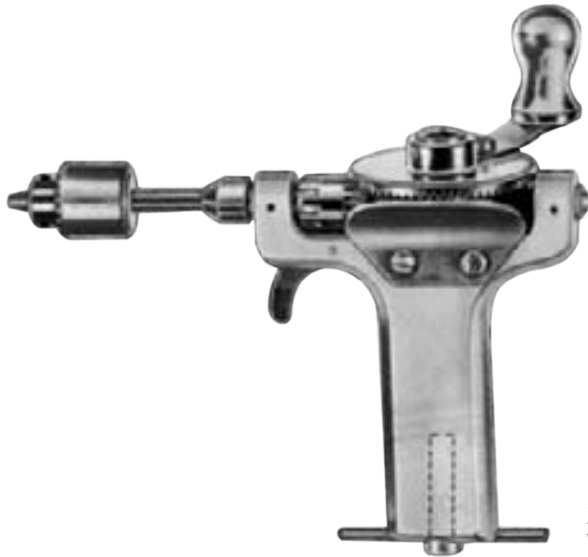

Bunnell  
24-282-00

24-282-01  
Wrench



Ralk  
24-285-01

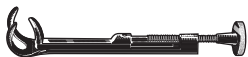

**Hand Drills**

Handbohrapparate  
Perforadores de mano

Perforateurs à main  
Perforatori a mano

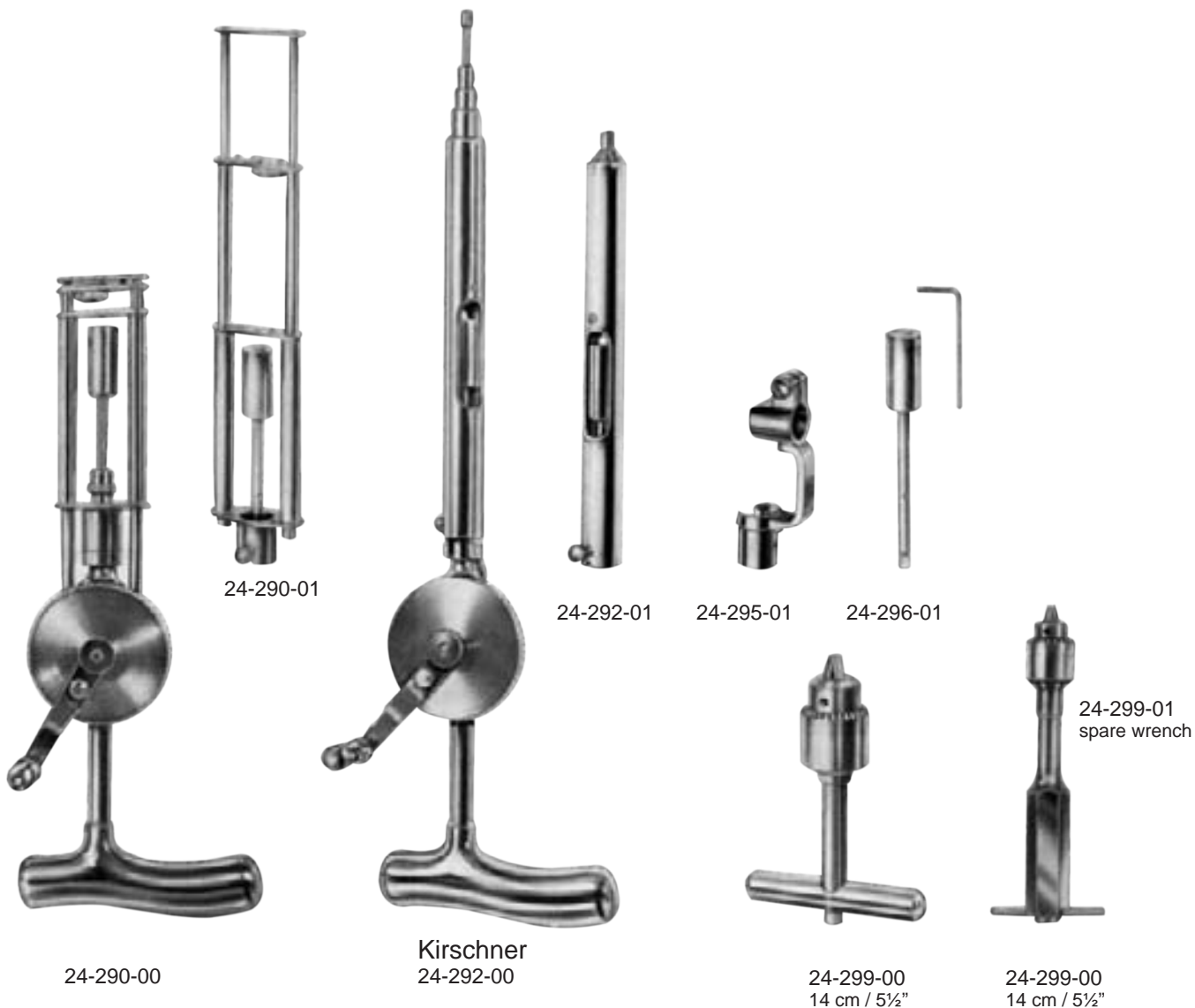

- 24-290-00 -Hand Drill with telescope wire drill guide  
24-290-01 coupling bow 24-295-01 and  
chuck with key
- 24-290-01 - Telescopic Wire Drill Guide, with chuck and  
fitting 24-290-00
- 24-292-00 -Hand Drill with telescopic wire drill guide  
24-292-01 coupling bow 24-295-01 and chuck
- 24-292-01 -Telescopic Wire Drill Guide with chuck and  
Key 24-296-01 fitting 24-292-00
- 24-295-01 - Coupling-bow only for wire drill guide  
24-290-01 and 24-292-01
- 24-298-01 - Handle with chuck and key, accomodating  
and extracting nails, guide pins, and wire  
guide drills
- 24-299-00 -Hand Drill, perforated, with three-jaw-chuck  
and key, accomodating up to 3.95mm  
(5/32")



### Instruments for Küntscher Nails

Instrumentarium für Küntscher - Nägel  
Instrumentos para clavos Küntscher

Instrumentation pour les clous de Küntscher  
Strumenti per chiodi Küntscher



1/8

24-308-00



1/8

Küntscher  
24-308-26



1/8

Küntscher  
24-308-35



ø 2.5 mm 24-310-02  
ø 3 mm 24-310-03  
ø 5 mm 24-310-05  
ø 6 mm 24-310-06



ø 2 mm  
24-312-02



ø 3 mm  
24-312-03



ø 5 mm  
24-312-05



ø 6 mm  
24-312-06



24-315-20





**Falcon**<sup>®</sup>

Surgical  
Instruments



25

BONE SURGERY

KNOCHENCHIRURGIE  
CIRUGÍA ÓSEA  
CHIRURGIE OSSEUSE  
CHIRURGIA OSSEA

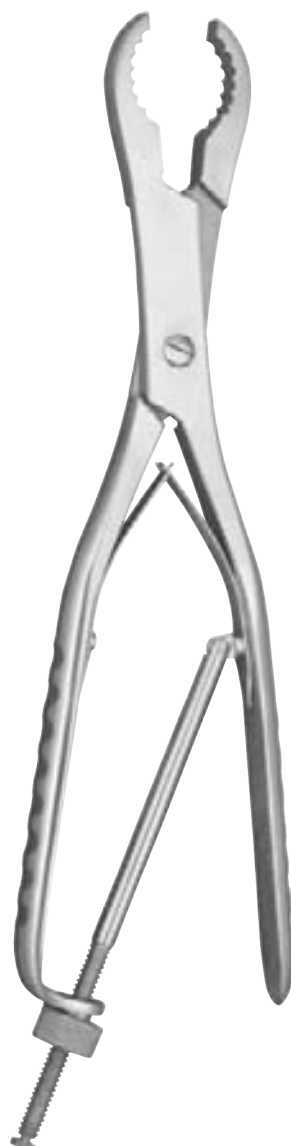



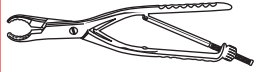

**Chisels, Gouges**

Flachmeißel, Hohlmeißel  
Cinceles, Gubias

Ciseaux-burins, Gouges  
Scalpelli, Sgorbie

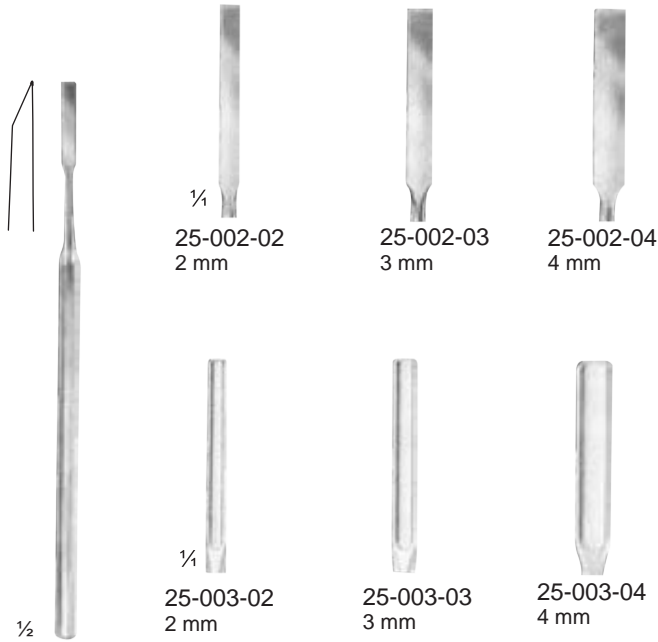

**Buckley**

25-002-02 - 25-003-04  
16 cm / 6¼"

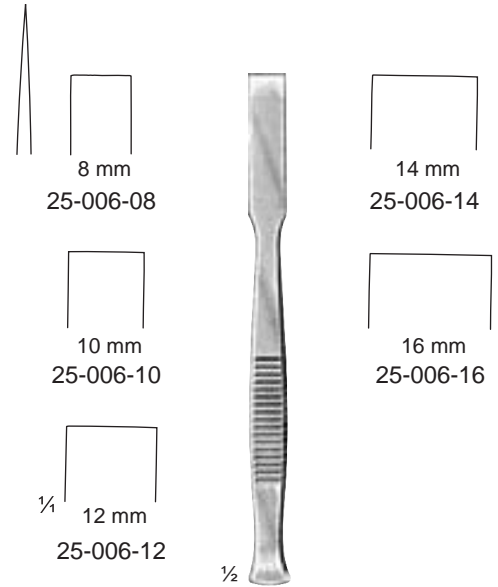

25-006-08 - 25-006-16  
13.5 cm / 5¼"

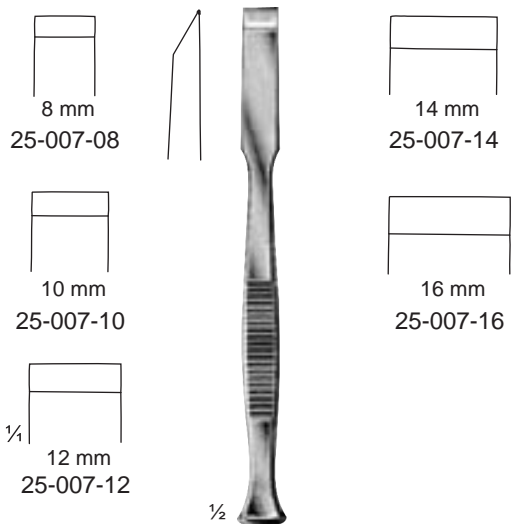

25-007-08 - 25-007-16  
13.5 cm / 5¼"

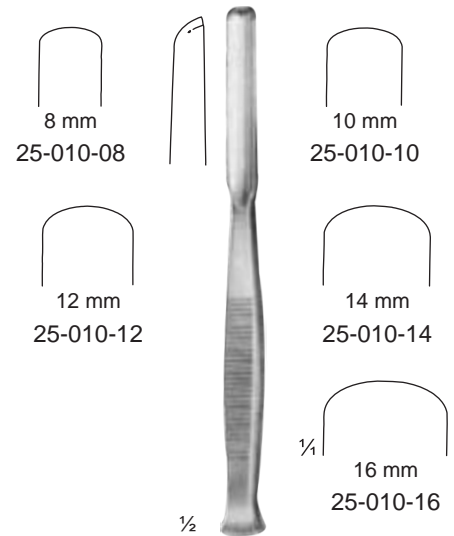

25-010-08 - 25-010-16  
13.5 cm / 5¼"



**Gouges, Bone Chisels, Osteotomes**

Hohlmeißel, Knochenmeißel, Osteotome  
Gubias, Cinceles, Osteótomos

Gouges, Ciseaux-burins, Ostéotomes  
Sgorbie, Scalpelli, Osteotomi



**Gillies**  
25-017-05 = 5 mm  
25-017-07 = 7 mm  
25-017-09 = 9 mm  
14 cm / 5½"



**Lucas**  
25-022-04 = 4mm  
25-022-06 = 6mm  
16 cm / 6¼"



**Lucas**  
25-025-03 = 3 mm  
25-025-05 = 5 mm  
16 cm / 6¼"



**East Grinstead  
(Ward)**  
25-028-03 = 3 mm  
25-028-05 = 5 mm  
18 cm / 7"

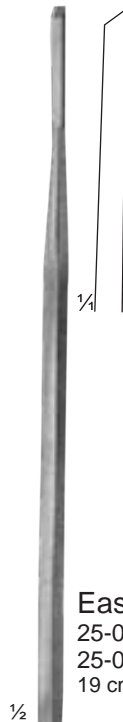

**Eastman**  
25-031-03 = 3 mm  
25-031-05 = 5 mm  
19 cm / 7½"



**East Grinstead  
(Ward)**  
25-034-03 = 3 mm  
25-034-05 = 5 mm  
Osteotomes  
18 cm / 7"

**Chisels, Gouges**

Flachmeißel, Hohlmeißel  
Cinceles, Gubias

Ciseaux-burins, Gouges  
Scalpelli, Sgorbie

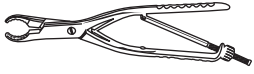

2 mm  
25-043-02  
13.5 cm / 5¼"

2 mm  
25-046-02  
17 cm / 6¾"

2 mm  
25-049-02  
13.5 cm / 5¼"

2 mm  
25-052-02  
17 cm / 6¾"

4 mm  
25-056-04

4 mm  
25-059-04

3 mm  
25-043-03  
13.5 cm / 5¼"

3 mm  
25-046-03  
17 cm / 6¾"

3 mm  
25-049-03  
13.5 cm / 5¼"

3 mm  
25-052-03  
17 cm / 6¾"

6 mm  
25-056-06

6 mm  
25-059-06

4 mm  
25-043-04  
13.5 cm / 5¼"

4 mm  
25-046-04  
17 cm / 6¾"

4 mm  
25-049-04  
13.5 cm / 5¼"

4 mm  
25-052-04  
17 cm / 6¾"

8 mm  
25-056-08

8 mm  
25-059-08

5 mm  
25-043-05  
13.5 cm / 5¼"

5 mm  
25-046-05  
17 cm / 6¾"

5 mm  
25-049-05  
13.5 cm / 5¼"

5 mm  
25-052-05  
17 cm / 6¾"

10 mm  
25-056-10

10 mm  
25-059-10

6 mm  
25-043-06  
13.5 cm / 5¼"

6 mm  
25-046-06  
17 cm / 6¾"

6 mm  
25-049-06  
13.5 cm / 5¼"

6 mm  
25-052-06  
17 cm / 6¾"

12 mm  
25-056-12

12 mm  
25-059-12

**Partsch**  
25-043-02 - 25-046-06

**Partsch**  
25-049-02 - 25-052-06

**Alexander**  
25-056-04 - 25-056-14  
18 cm / 7"

**Alexander**  
25-059-04 - 25-059-14  
18 cm / 7"



25-061-01  
11 cm / 4½"

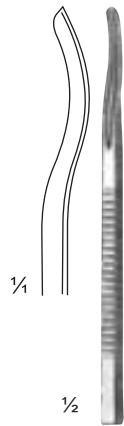

25-061-02  
11 cm / 4½"

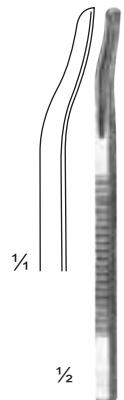

25-061-03  
11 cm / 4½"

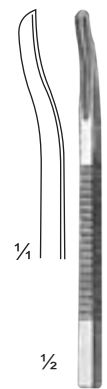

25-061-04  
11 cm / 4½"

**Buck-Gramcko**  
25-061-01 - 25-061-04

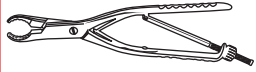

**Chisels, Gouges**

Flachmeißel, Hohlmeißel  
Cinceles, Gubias

Ciseaux-burins, Gouges  
Scalpelli, Sgorbie

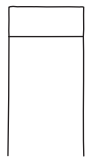

10 mm

25-069-10



10 mm

25-072-10



10 mm

25-075-10

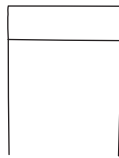

15 mm

25-069-15

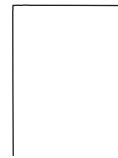

15 mm

25-072-15

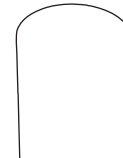

15 mm

25-075-15

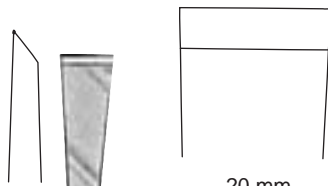

20 mm  
25-069-20



20 mm  
25-072-20

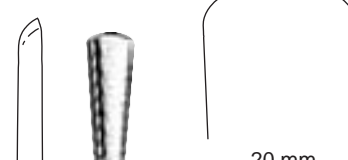

20 mm  
25-075-20

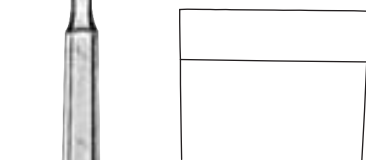

25 mm  
25-069-25

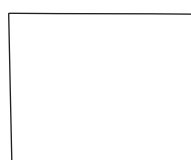

25 mm  
25-072-25

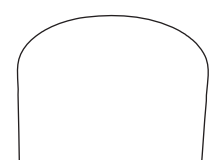

25 mm  
25-075-25



Stille

25-069-10 - 25-069-25  
20 cm / 8"



Stille

25-072-10 - 25-072-25  
20 cm / 8"



Stille

25-075-10 - 25-075-25  
20 cm / 8"



**Chisels, Gouges**

Flachmeißel, Hohlmeißel  
Cinceles, Gubias

Ciseaux-burins, Gouges  
Scalpelli, Sgorbie

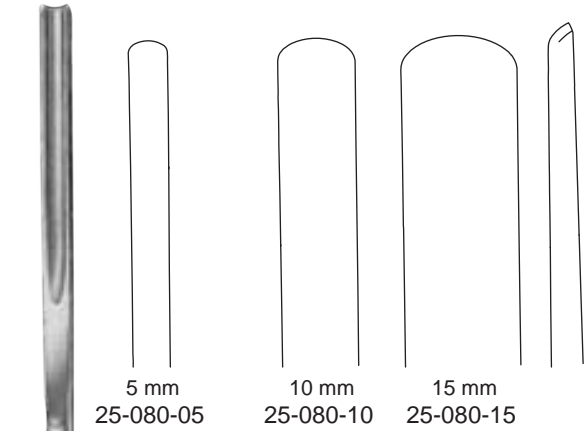

5 mm  
25-080-05

10 mm  
25-080-10

15 mm  
25-080-15

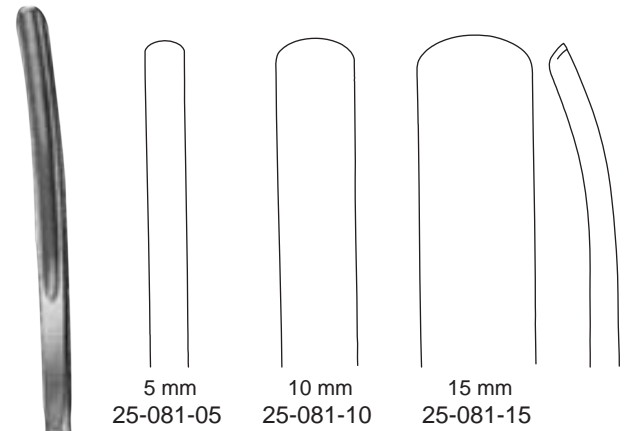

5 mm  
25-081-05

10 mm  
25-081-10

15 mm  
25-081-15

½

**Lexer**

25-080-05 - 25-080-15  
25 cm / 10"  
Handle from artificial wood

½

**Lexer**

25-081-05 - 25-081-15  
25 cm / 10"  
Handle from artificial wood



4 mm  
25-084-04

6 mm  
25-084-06

8 mm  
25-084-08



4 mm  
25-085-04

6 mm  
25-085-06

8 mm  
25-085-08

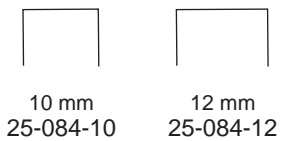

10 mm  
25-084-10

12 mm  
25-084-12

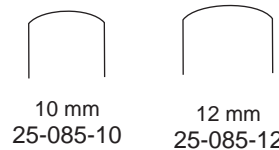

10 mm  
25-085-10

12 mm  
25-085-12

½

**Mini-Lexer**

25-084-04 - 25-084-12  
18 cm / 7"

Handle from artificial wood

½

**Mini-Lexer**

25-085-04 - 25-085-12  
18 cm / 7"

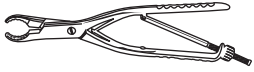

**Gouges, Bone Chisels, Osteotomes**

Hohlmeißel, Knochenmeißel, Osteotome  
Gubias, Cinceles, Osteótomos

Gouges, Ciseaux-burins, Ostéotomes  
Sgorbie, Scalpelli, Osteotomi

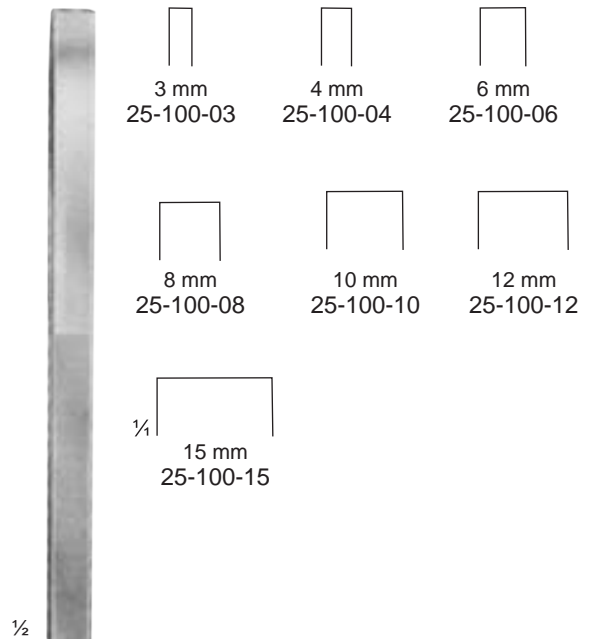
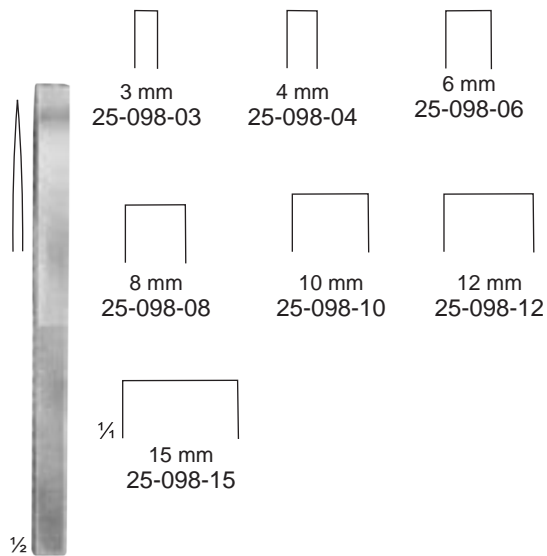
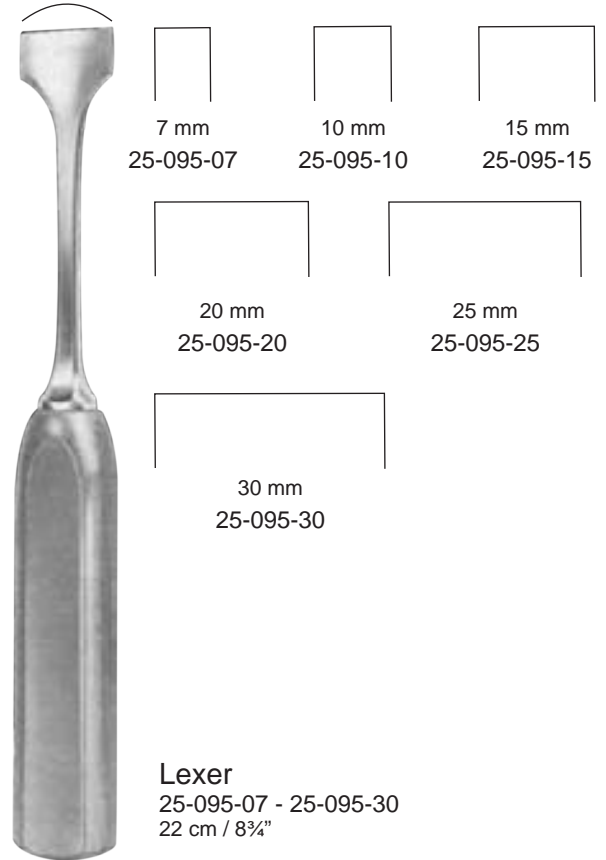
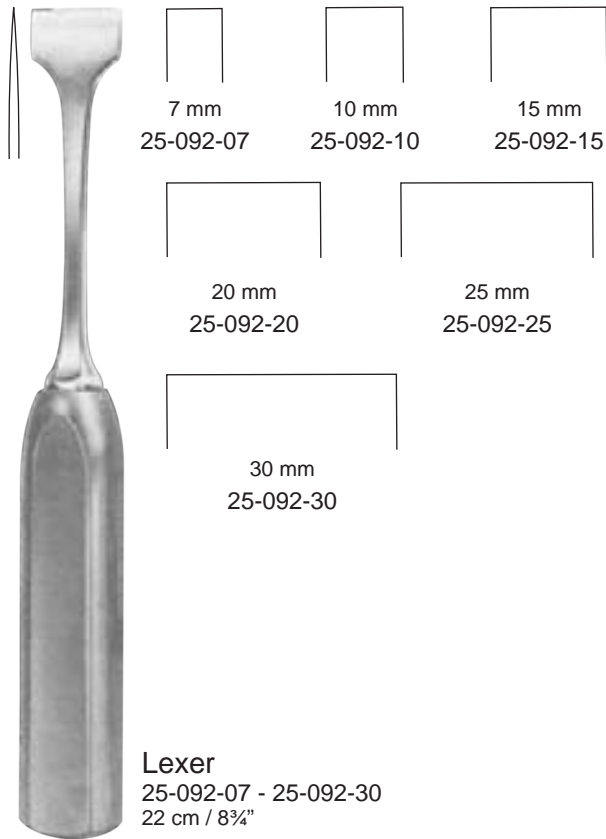



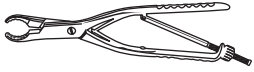

### Osteotomes, Chisels, Gouges

Osteotome, Flachmeißel, Hohlmeißel  
Osteótomos, Cinceles, Gubias

Ostéotomes, Ciseaux-burins, Gouges  
Osteotomi, Scalpelli, Sgorbie

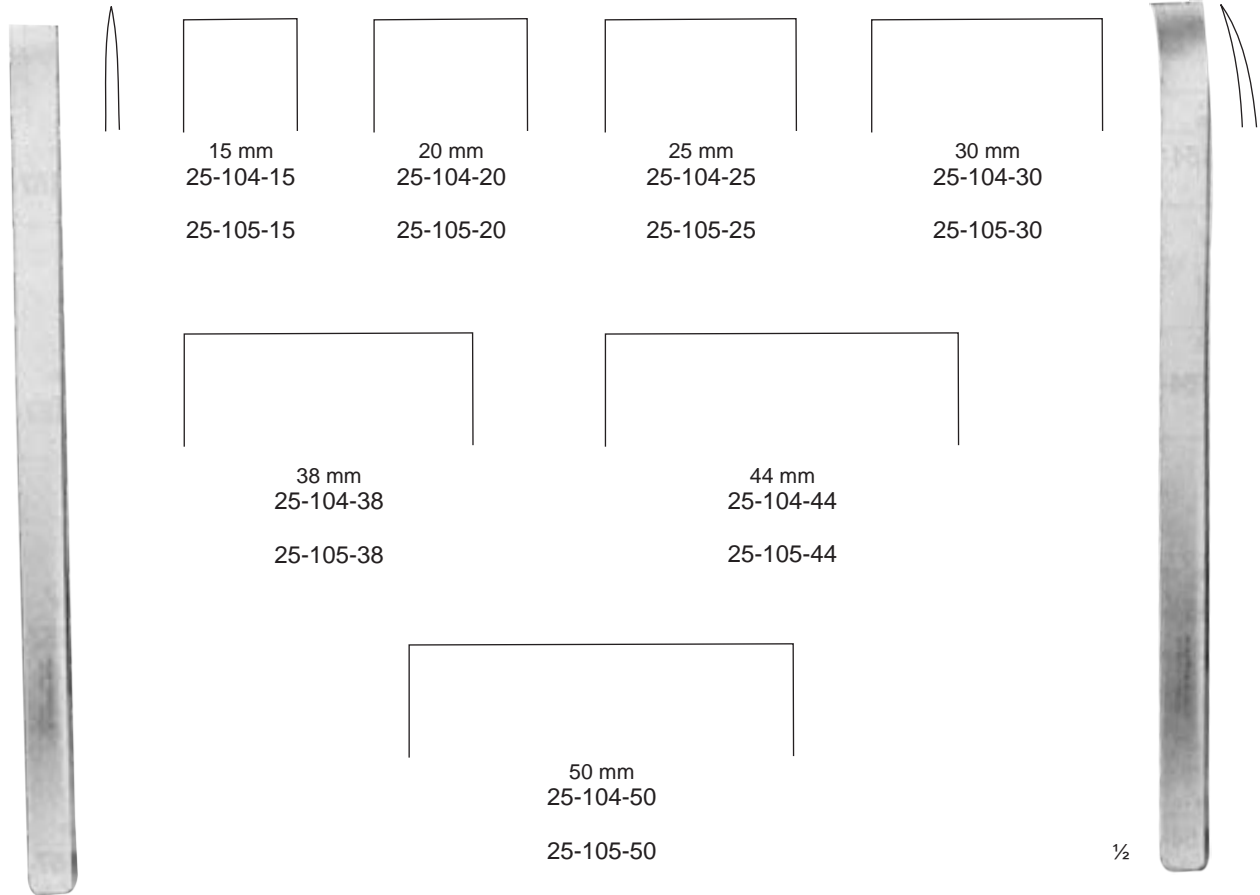

**Lambotte**  
25-104-15 - 25-104-50  
24 cm / 9½"

**Lambotte**  
25-105-15 - 25-105-90  
23 cm / 9"

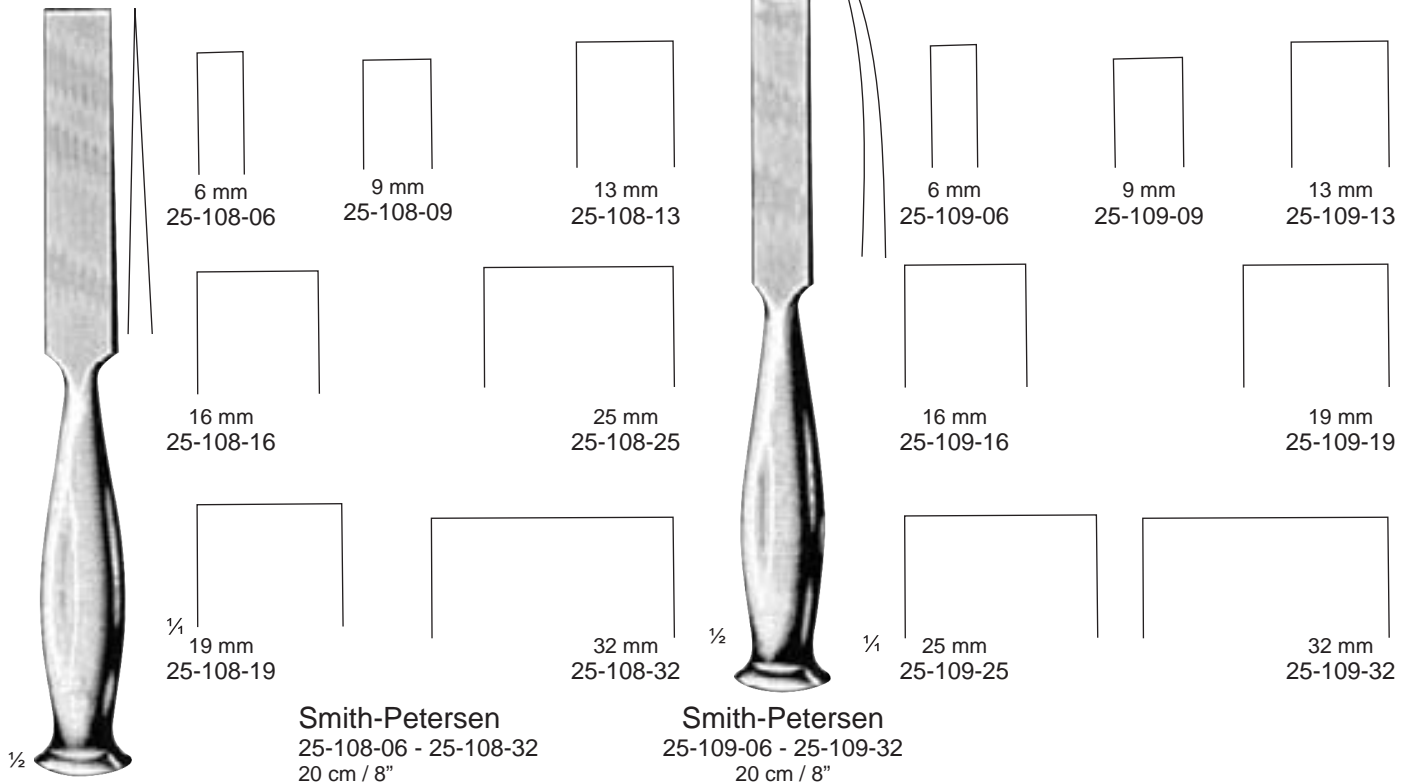

**Smith-Petersen**  
25-108-06 - 25-108-32  
20 cm / 8"

**Smith-Petersen**  
25-109-06 - 25-109-32  
20 cm / 8"

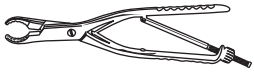

**Gouges, Bone Chisels, Osteotomes**

Hohlmeißel, Knochenmeißel, Osteotome  
Gubias, Cinceles, Osteótomos

Gouges, Ciseaux-burins, Ostéotomes  
Sgorbie, Scalpelli, Osteotomi

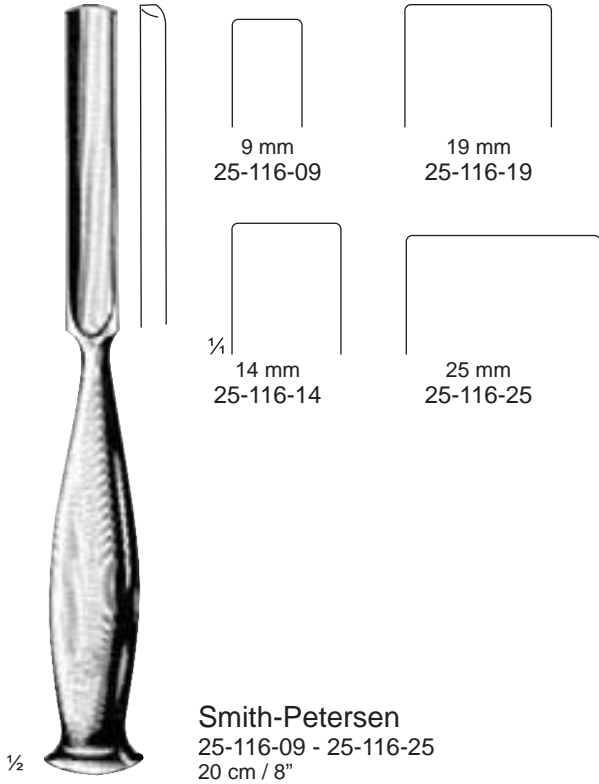

**Smith-Petersen**  
25-116-09 - 25-116-25  
20 cm / 8"

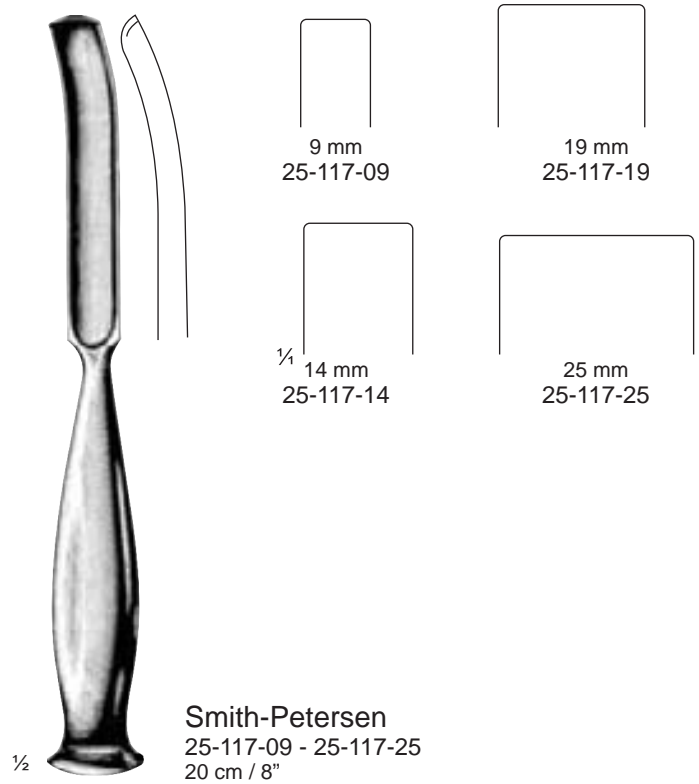

**Smith-Petersen**  
25-117-09 - 25-117-25  
20 cm / 8"

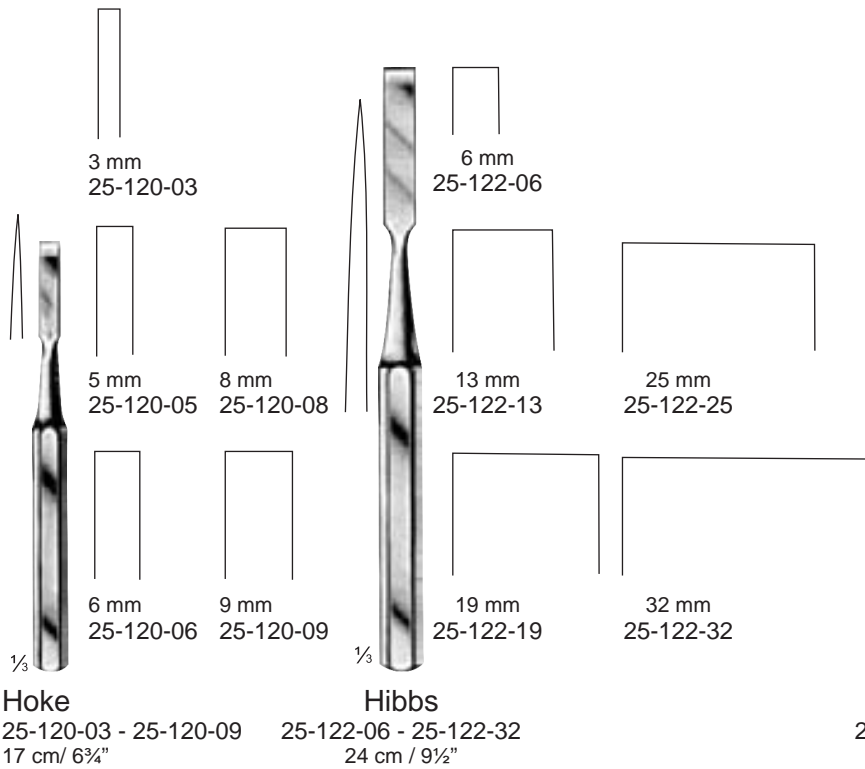

**Hoke**  
25-120-03 - 25-120-09  
17 cm / 6 3/4"

**Hibbs**  
25-122-06 - 25-122-32  
24 cm / 9 1/2"

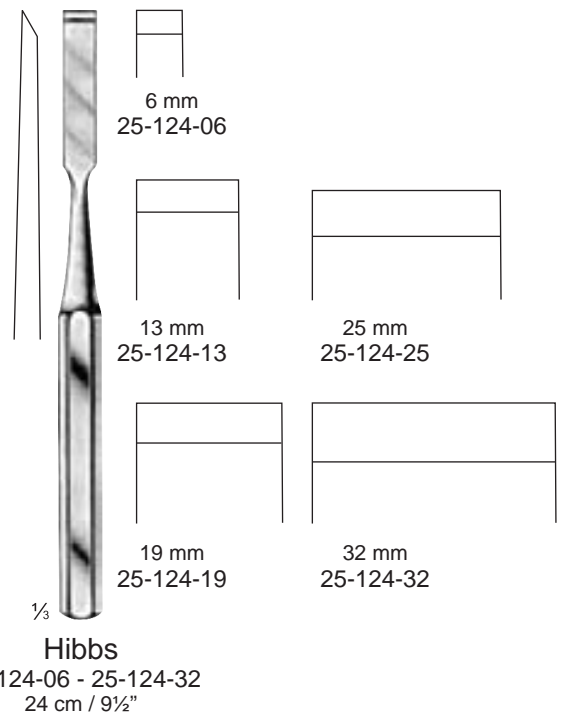

**Hibbs**  
25-124-06 - 25-124-32  
24 cm / 9 1/2"

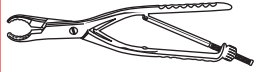

**Chisels, Gouges**

Flachmeißel, Hohlmeißel  
Cinceles, Gubias

Ciseaux-burins, Gouges  
Scalpelli, Sgorbie

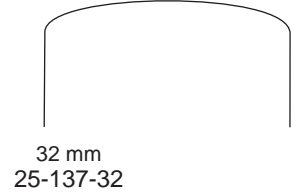
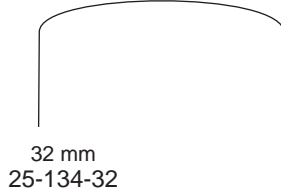
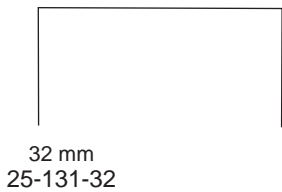
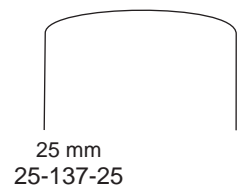
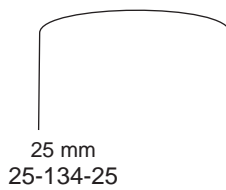
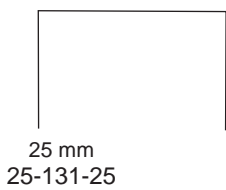
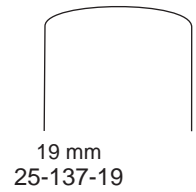
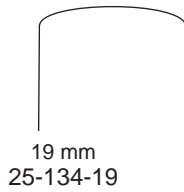
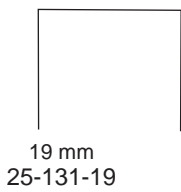
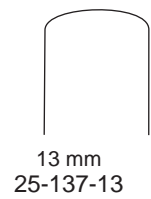
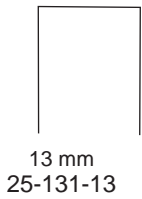
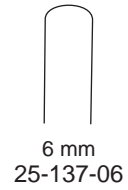
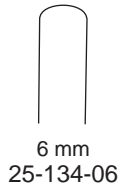
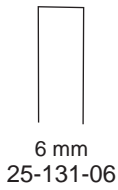

1/3

Hibbs

25-131-06 - 25-131-32  
24 cm / 9½"



1/3

Hibbs

25-134-06 - 25-134-32  
24 cm / 9½"



1/3

Hibbs

25-137-06 - 25-137-32  
24 cm / 9½"

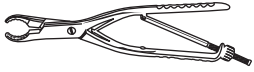

### Tampers, Bone Rasps

Stößel, Knochenraspeln  
 Punzones metálicos, Escofinas para hueso

Pilons métalliques, Râpes pour os  
 Pestoni metallici, Raspe per ossa

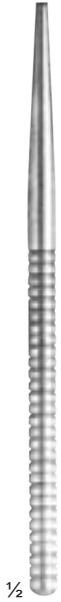

$\frac{1}{4}$  2 mm ø  
 25-144-02

3 mm ø  
 25-144-03

4 mm ø  
 25-144-04

5 mm ø  
 25-144-05

6 mm ø  
 25-144-06

8 mm ø  
 25-144-08

10 mm ø  
 25-144-10

$\frac{1}{2}$

25-144-02 - 25-144-10  
 15.5 cm / 6"



$\frac{1}{3}$   
**Putti**  
 25-147-27  
 27cm / 10½"



$\frac{1}{3}$   
**Putti**  
 25-149-30  
 30 cm / 12"

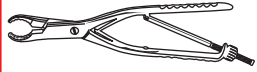

**Mallets**

Hämmer  
Martillos

Maillets  
Martelli

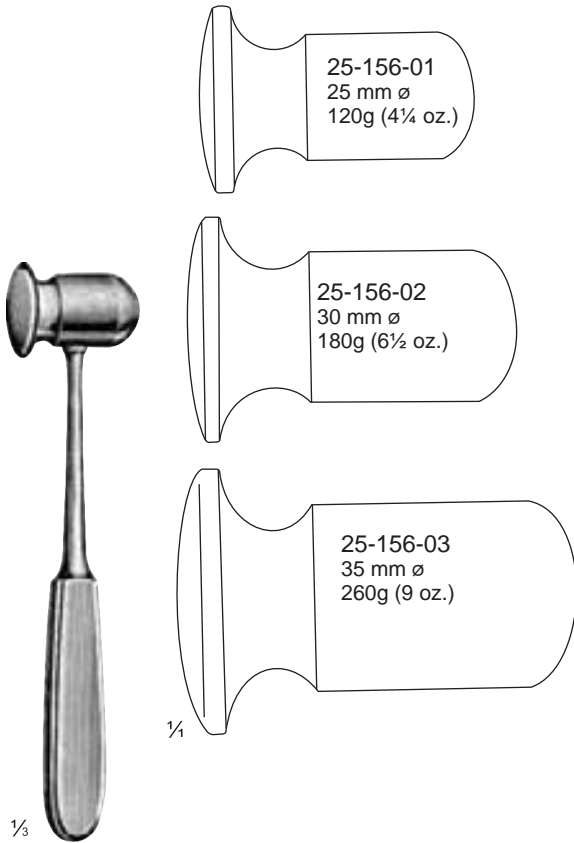

**Doyen**  
25-156-01- 25-156-03  
21 cm / 8¼"



**Williger**  
25-158-01 - 25-158-03  
24 cm / 9½"

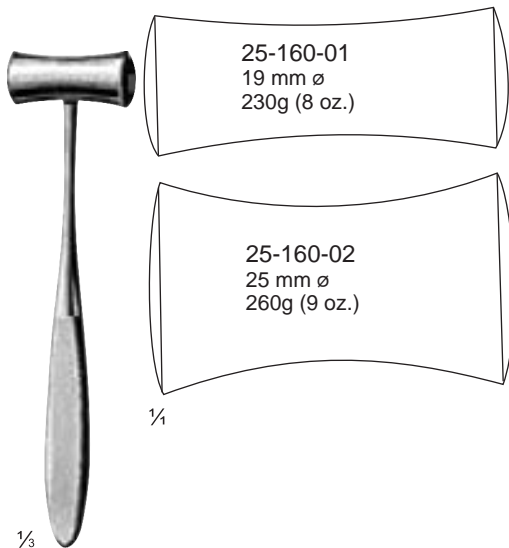

**Lucae**  
25-160-01 - 25-160-02  
19 cm / 7½"



**Collin**  
25-162-20  
20 cm / 8"



**Thiess**  
25-164-01  
16.5 cm / 6½"

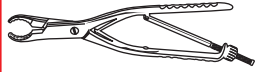

**Mallets**

Hämmer

Maillets

Martillos

Martelli

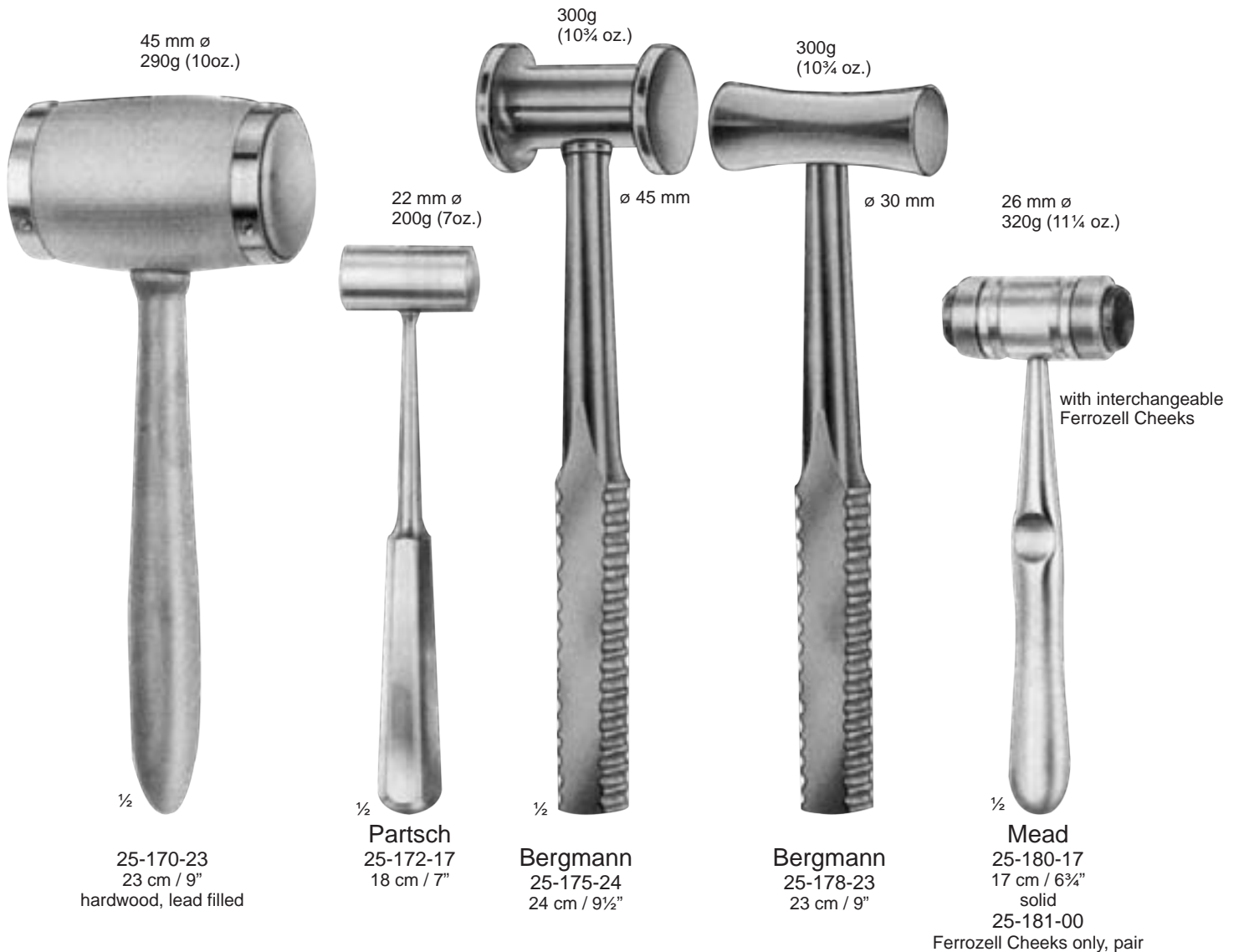

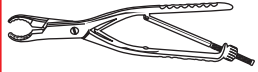

**Mallets**

Hämmer                      Maillets  
 Martillos                    Martelli



25-187-26  
26.5 cm / 10 1/2"



25-190-26  
26 cm / 10 1/4"  
Ferozell, lead filled



**Steinbach**  
25-192-24  
24 cm / 9 1/2"



25-194-26  
26 cm / 10 1/4"  
Ferozell, without lead

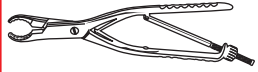

**Mallets**

Hämmer

Maillets

Martillos

Martelli

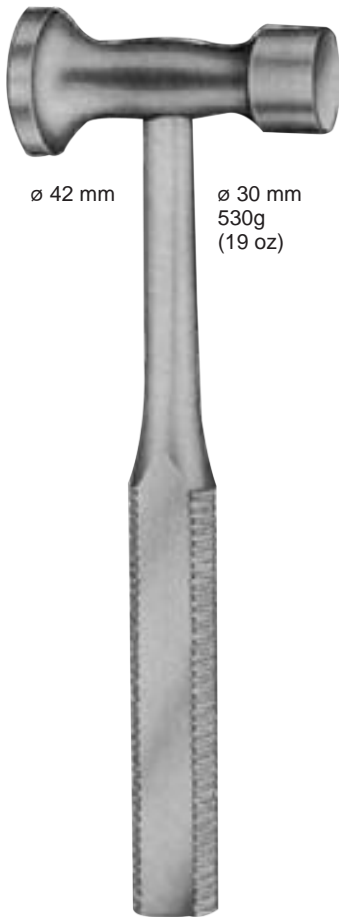

ø 42 mm

ø 30 mm  
530g  
(19 oz)

25-200-24  
24 cm / 9½"



30 mm ø  
480g

⅓

25-202-24  
24 cm / 9½"  
steel, solid  
with Ferrozell handle

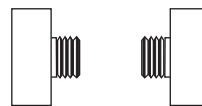

37 mm ø  
370g  
12¾oz

25-205-00  
Spare Cheeks, pair

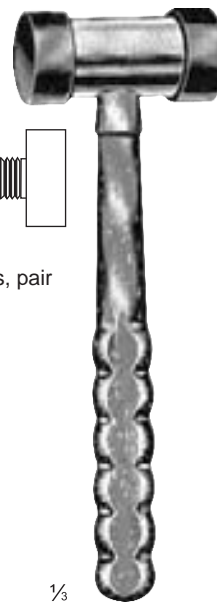

⅓

**Ferozell**  
25-204-22  
22.5 cm / 9"  
steel, solid,  
with Ferrozell cheeks  
and handle



30 mm ø  
125g (4 oz.)

⅓

**Ferozell**  
25-206-20  
20 cm / 8"  
Ferozell, solid



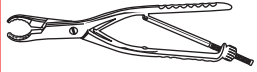

**Mallets**

Hämmer

Maillets

Martillos

Martelli

35 mm ø  
450g (1 lb.)



25-212-26  
26.5 cm / 10½"  
steel, solid

50 mm ø  
900g



25-214-26  
26.5 cm / 10½"  
steel, solid



1/3  
25-216-24  
24 cm / 9½"  
steel, solid,  
with ferrozell handle

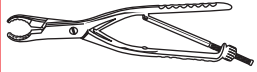

**Mallets**

Hämmer

Maillets

Martillos

Martelli

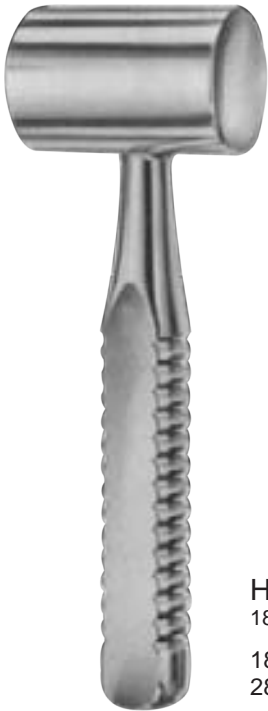

**Heath**

18.5 cm / 7¼"

18oz. = ø 40 mm = 25-222-18

28oz. = ø 45 mm = 25-223-18



ø 23 mm  
190g

**Fickling**

25-225-19  
19 cm / 7½"



ø 22 mm  
165g

25-228-19  
19 cm / 7½"



ø 27 mm  
140g

**Hajek**

25-230-22  
22 cm / 8¾"

**Bone Currettes**

Scharfe Löffel  
Cucharillas cortantes

Curettes tranchantes  
Curette taglienti

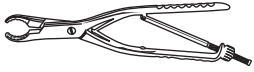

1/2

**Volkman**

25-236-01 - 25-236-40  
17 cm / 6 3/4"  
Handle from artificial wood



Fig. 0000  
25-236-40



Fig. 000  
25-236-30



Fig. 00  
25-236-20



Fig. 0  
25-236-10



Fig. 1  
25-236-01



1/4 Fig. 2  
25-236-02



Fig. 3  
25-236-03



Fig. 4  
25-236-04

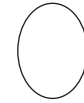

Fig. 5  
25-236-05

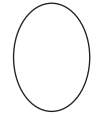

Fig. 6  
25-236-06



1/2

**Schede**

25-238-10 - 25-239-04  
17 cm / 6 3/4"



Fig. 000  
25-238-30



Fig. 00  
25-238-20



Fig. 0  
25-238-10



Fig. 1  
25-239-01



Fig. 2  
25-239-02



Fig. 3  
25-239-03



1/4 Fig. 4  
25-239-04



Fig. 0  
25-242-10



Fig. 1  
25-242-01



Fig. 2  
25-242-02



Fig. 3  
25-242-03



1/4 Fig. 4  
25-242-04



1/2

**Volkman**

25-242-01 - 25-242-10  
27 cm / 10 3/4"  
Handle from artificial wood

**Bone Currettes**

Scharfe Löffel  
Cucharillas cortantes

Curettes tranchantes  
Curette taglienti

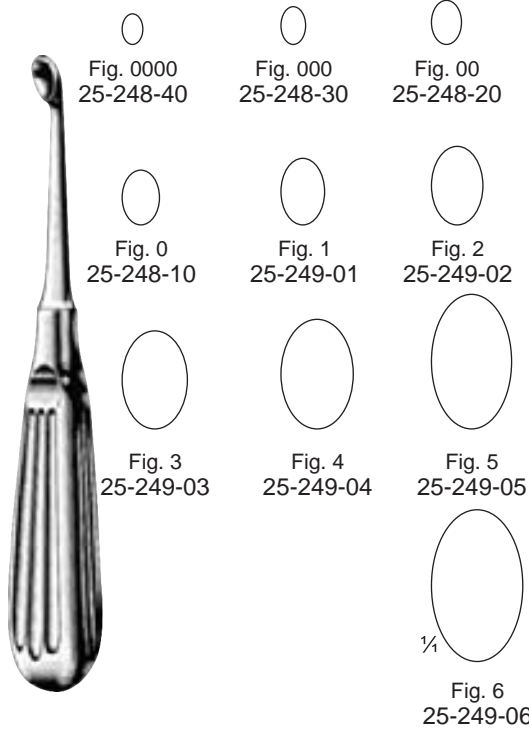

**Volkmann**  
25-248-10 - 25-249-06  
17 cm / 6<sup>3</sup>/<sub>4</sub>"

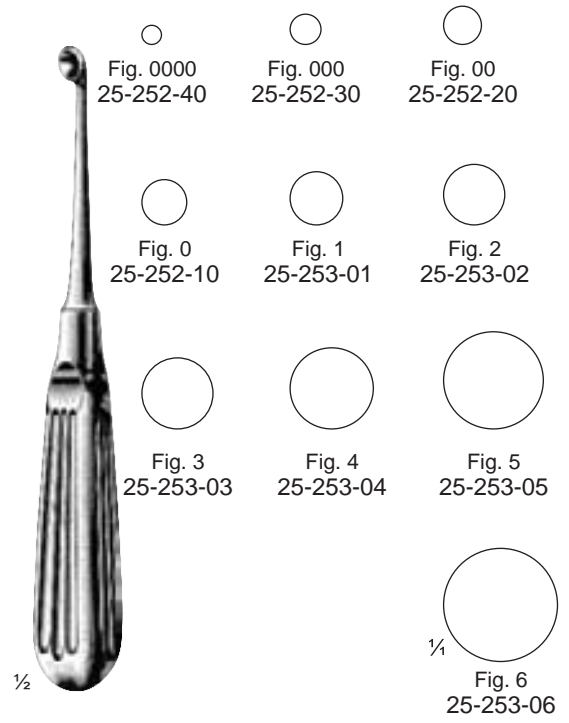

**Bruns**  
25-252-10 - 25-253-06  
17 cm / 6<sup>3</sup>/<sub>4</sub>"

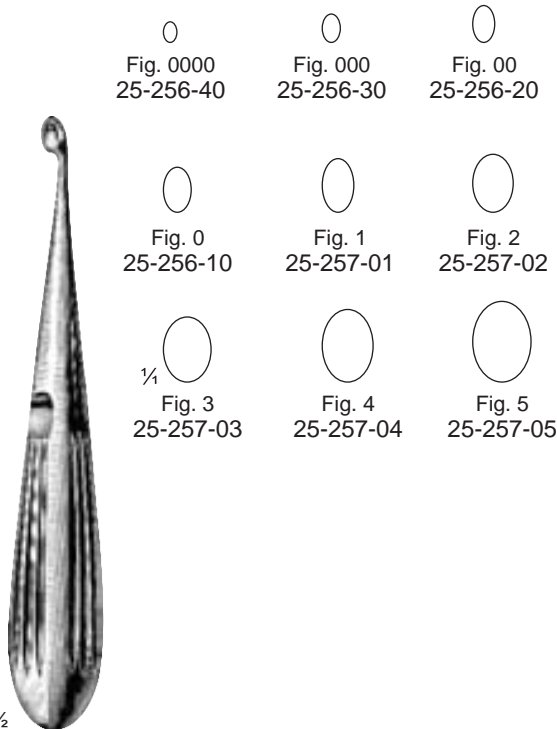

**Spratt**  
25-256-10 - 25-257-05  
17 cm / 6<sup>3</sup>/<sub>4</sub>"

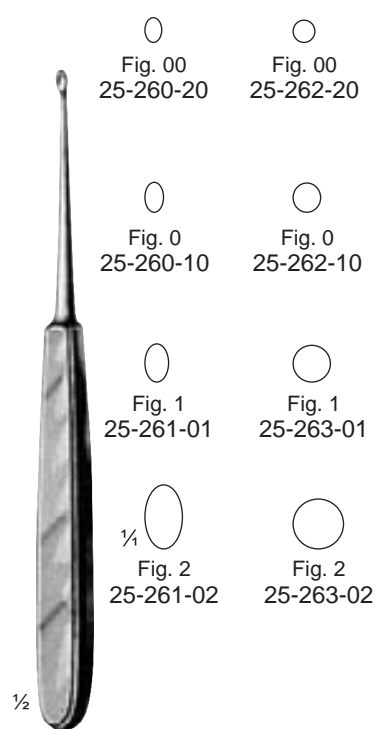

**Williger**  
25-260-10 - 25-263-02  
17.5 cm / 7"

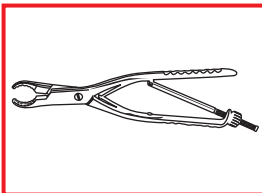

**Bone Currettes**

Scharfe Löffel  
Cucharillas cortantes

Curettes tranchantes  
Curette taglienti



- 25-270-30
- 25-270-20
- 25-270-10
- 25-271-01
- 25-271-02
- 25-271-03
- 25-271-04
- 25-271-05
- 25-271-06

**Brun's**  
25-270-10 - 25-271-06  
23 cm / 9"



- 25-274-25
- 25-275-25
- 25-277-25

**Scoville**  
25-274-25- 25-277-25  
25 cm / 9¾"



- 25-280-01
- 25-280-02
- 25-280-03
- 25-280-04
- 25-280-05
- ¼ ○  
25-280-06

**Simon**  
25-280-01 - 25-280-06  
24 cm / 9½"



- Fig. 1  
25-282-01
- Fig. 2  
25-282-02
- Fig. 3  
25-282-03
- Fig. 4  
25-282-04
- Fig. 5  
25-282-05
- Fig. 6  
25-282-06
- Fig. 1  
25-283-01
- Fig. 2  
25-283-02
- Fig. 3  
25-283-03
- Fig. 4  
25-283-04
- Fig. 5  
25-283-05
- Fig. 6  
25-283-06

- Fig. 1  
25-285-01
- Fig. 2  
25-285-02
- Fig. 3  
25-285-03
- ¼ ○  
Fig. 4  
25-285-04
- Fig. 5  
25-285-05
- Fig. 6  
25-285-06

**Mod. USA**  
25-282-01 - 25-285-06  
16 cm / 6¼"

**Bone Currettes**

Scharfe Löffel  
Cucharillas cortantes

Curettes tranchantes  
Curette taglienti

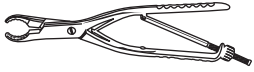

○  
25-292-01  
○  
25-292-02  
○  
¼  
25-292-03

**Halle**  
25-292-01 - 25-292-03  
21 cm / 8¼"



○  
25-294-13  
13 cm / 5"  
○  
25-294-14  
14 cm / 5½"  
○  
25-294-17  
17 cm / 6¼"

**Volkmann**  
25-294-13 - 25-294-17



○  
¼  
25-296-13  
13 cm / 5"  
○  
25-296-16  
16 cm / 6¼"  
○  
25-296-20  
20 cm / 8"

**Volkmann**  
25-296-13 - 25-296-20



○  
00  
○  
0  
○  
¼  
0  
○  
1  
25-298-00 25-298-01  
○  
1  
○  
2  
25-298-12

**Martini**  
25-298-00 - 25-298-12  
13.5 cm / 5¼"



○  
00  
○  
0  
○  
¼  
0  
○  
1  
25-300-00 25-300-01  
○  
1  
○  
2  
25-300-12

**Williger**  
25-300-00 - 25-300-12  
13.5 cm / 5¼"

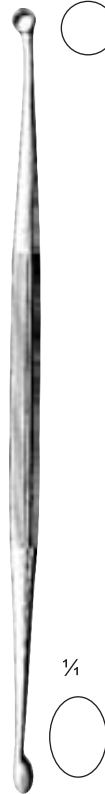

**Volkmann**  
25-302-21  
21 cm / 8¼"  
Oval/round



25-305-01



25-305-02



25-305-03



**Volkmann**  
25-305-01 - 25-305-03  
22 cm / 8½"



**Periosteal Elevators**

Raspatorien  
Periostótomos

Rugines-raspatoires  
Periostotomi

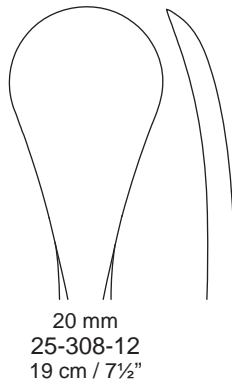
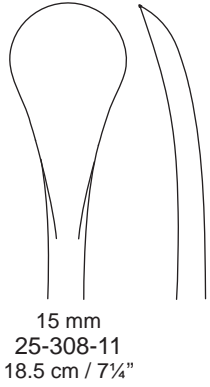
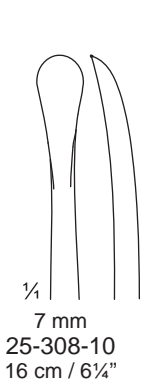

**Hoehn**  
25-308-10 - 25-308-12



**Langenbeck**  
25-310-01 - 25-310-04

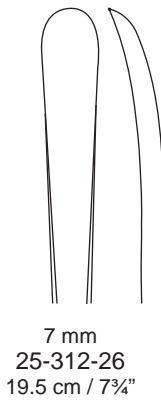
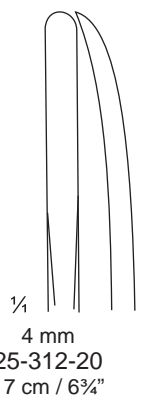
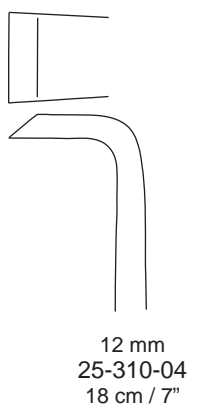
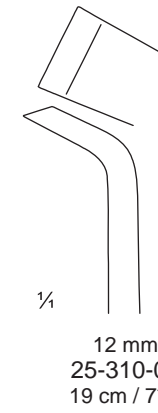
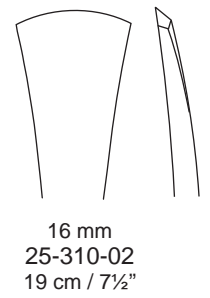
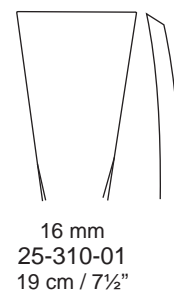

**Cushing**  
25-312-20 - 25-312-26

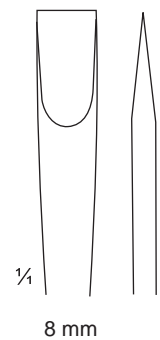

**Cushing**  
25-314-17  
17 cm / 6¾"

**Periosteal Elevators**

Raspatorien  
Periostótomos

Rugines-raspatoires  
Periostotomi

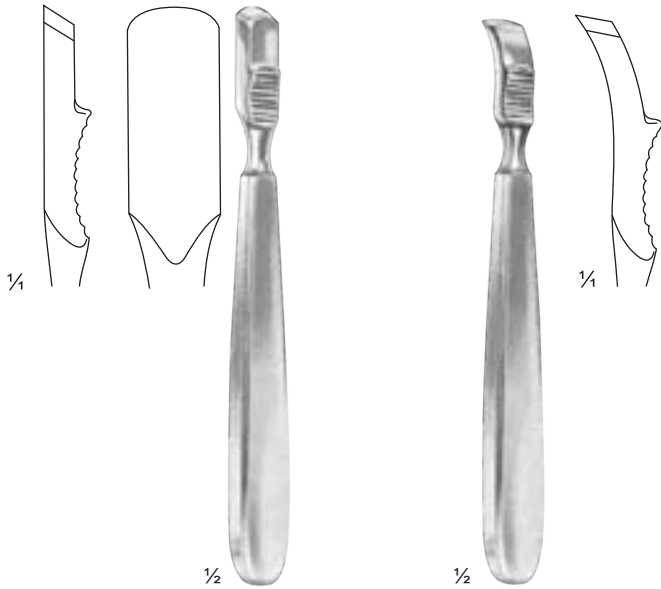

**Farabeuf**  
25-320-15  
15 cm / 6"

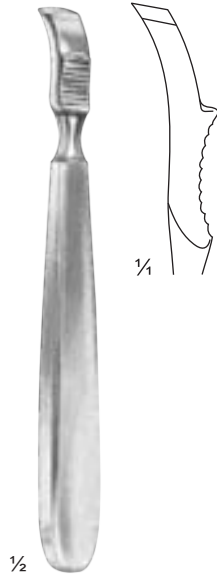

**Farabeuf**  
25-323-15  
15 cm / 6"

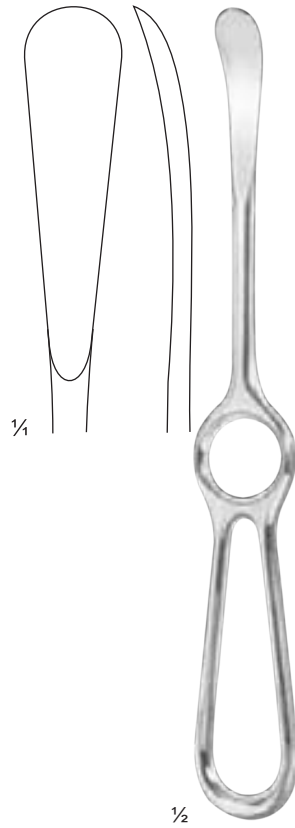

**Sedillot**  
25-325-21  
21 cm / 8 1/4"

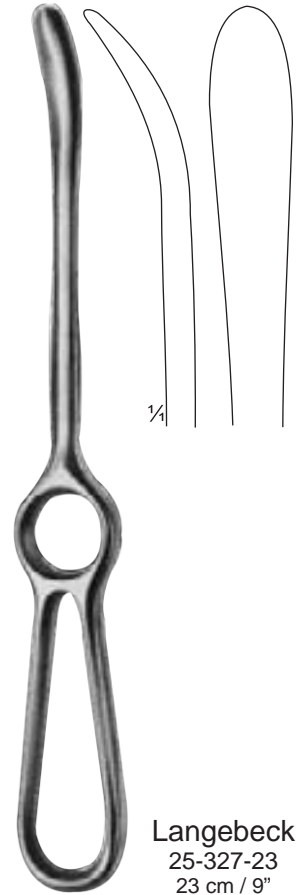

**Langebeck**  
25-327-23  
23 cm / 9"

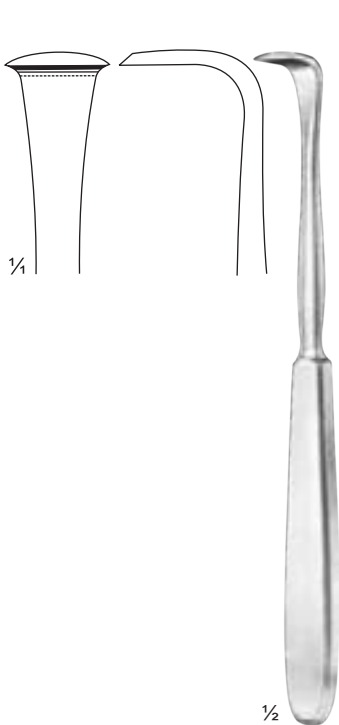

**Langenbeck**  
25-330-18  
18 cm / 7"

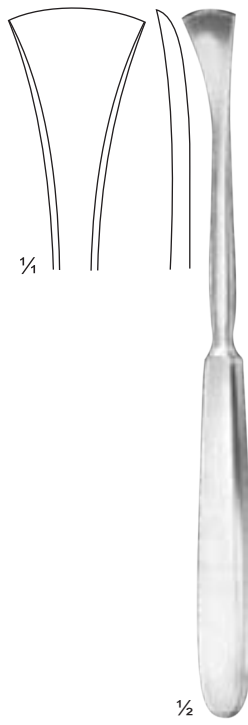

**Langenbeck**  
25-332-19  
19 cm / 7 1/2"



**Sebillaue**  
25-335-17  
17.5 cm / 7"

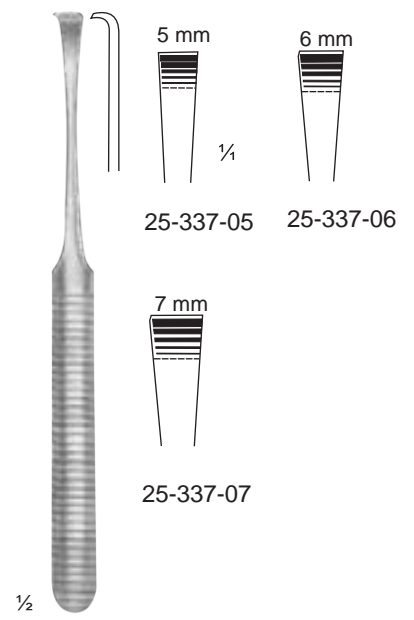

25-337-05 - 25-337-07  
16 cm / 6 1/4"



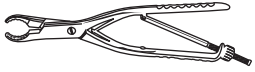

**Periosteal Elevators**

Raspatorien  
Periostótomos

Rugines-raspatoires  
Periostotomi

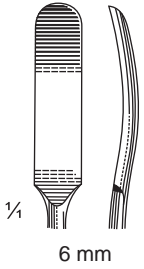

Handle  
from artificial wood

1/2  
25-344-18  
18 cm / 7"



Handle  
from artificial wood

1/2  
25-347-18  
18 cm / 7"



Handle  
from artificial wood

1/2  
25-349-18  
18 cm / 7"

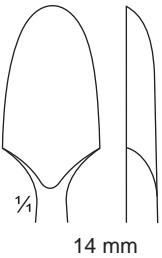

Handle  
from artificial wood

1/2  
25-352-20  
20 cm / 8"

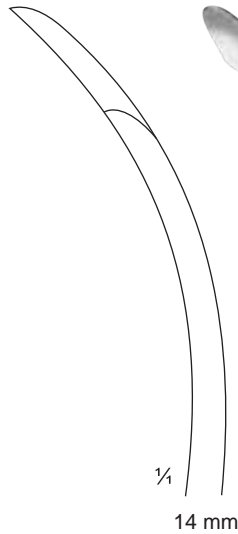

Handle  
from artificial wood

1/2  
25-355-20  
20 cm / 8"

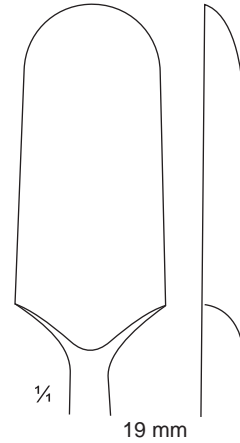

Handle  
from artificial wood

1/2  
25-357-20  
20 cm / 8"

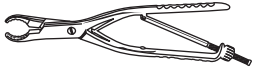

**Periosteal Elevators**

Raspatorien                      Rugines-raspatoires  
 Periostótomos                  Periostotomi

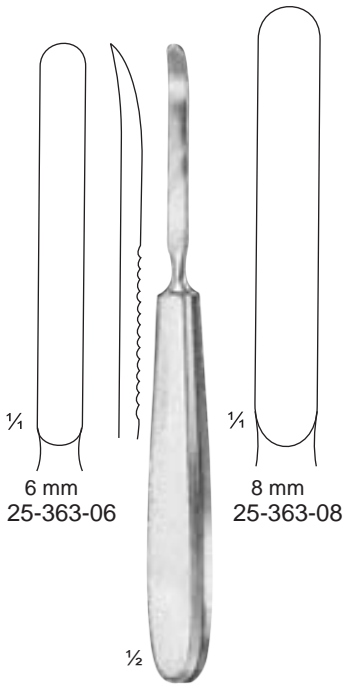

6 mm  
25-363-06

8 mm  
25-363-08

25-363-06 - 25-363-08  
17 cm / 6 3/4"

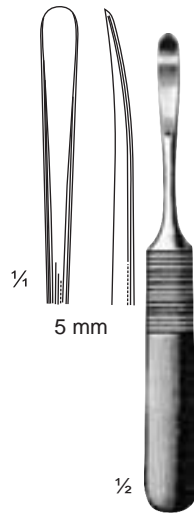

5 mm

Williger  
25-366-13  
13 cm / 5"

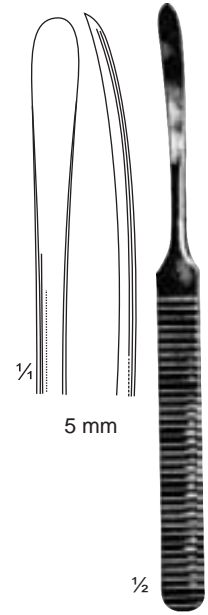

5 mm

Williger  
25-368-16  
16 cm / 6 1/4"



Lambotte  
25-371-10 - 25-371-25  
21 cm / 8 1/4"

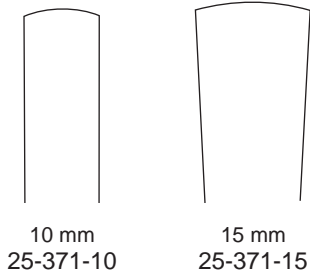

10 mm  
25-371-10

15 mm  
25-371-15

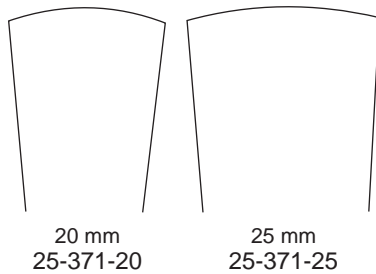

20 mm  
25-371-20

25 mm  
25-371-25

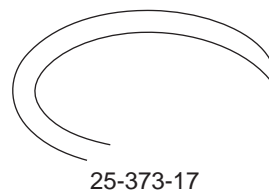

25-373-17



25-375-17

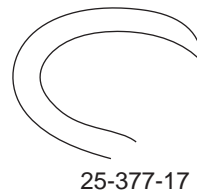

25-377-17



25-379-17



Doyen  
25-373-17 - 25-379-17  
17 cm / 6 3/4"



**Periosteal Elevators**

Raspatorien  
Periostótomos

Rugines-raspatoires  
Periostotomi

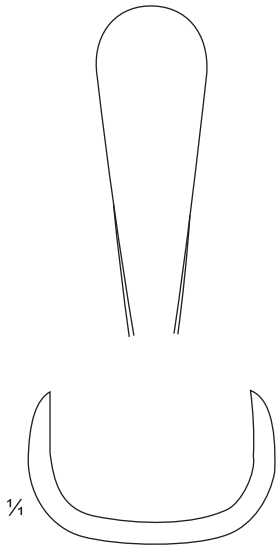

**Matson**  
25-385-22  
22 cm / 8 3/4"



25-387-19  
sharp  
25-388-19  
blunt

**Freer**  
19 cm / 7 1/2"



**Freer**  
25-391-18  
18 cm / 7"

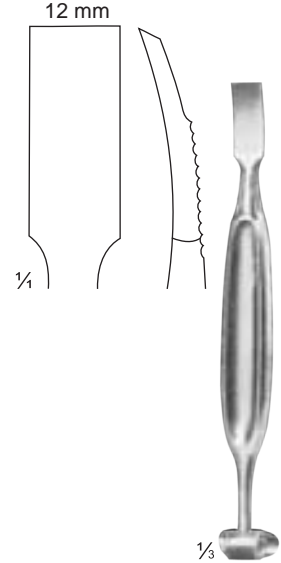

**Alexander**  
25-393-20  
20 cm / 8"



**Semb**  
25-396-01 - 25-396-05

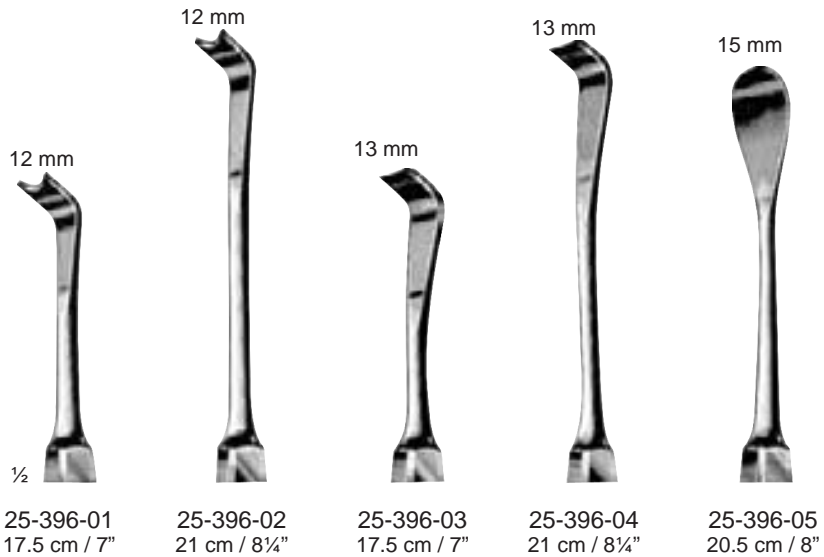

25-396-01  
17.5 cm / 7"

25-396-02  
21 cm / 8 1/4"

25-396-03  
17.5 cm / 7"

25-396-04  
21 cm / 8 1/4"

25-396-05  
20.5 cm / 8"

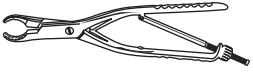

### Bone Files

Knochenfeilen  
Limas para huesos

Limes à os  
Lime per ossa

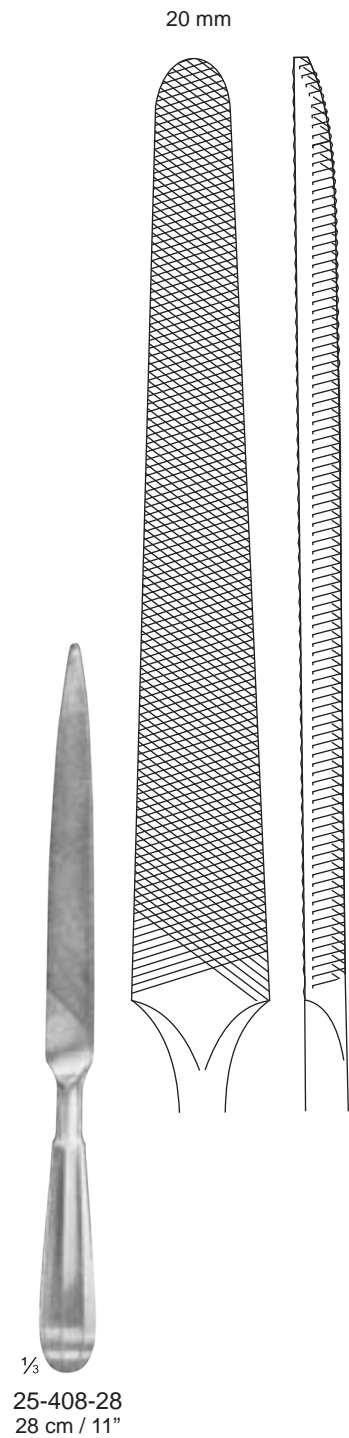
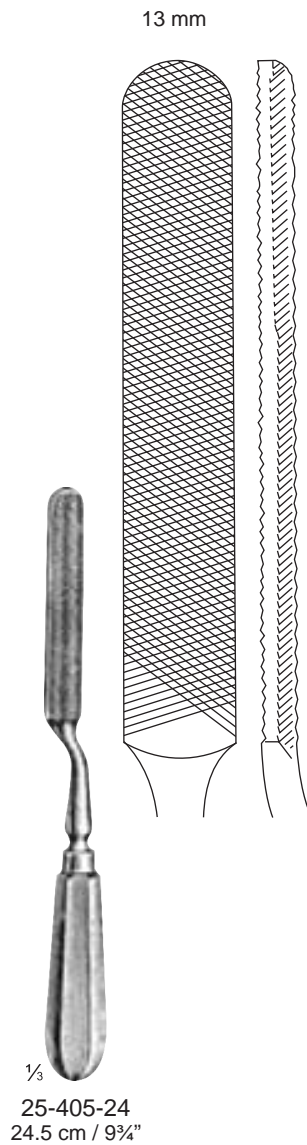

**Elevators**

Elevatorien  
Elevadores

Elévateurs  
Elevatori

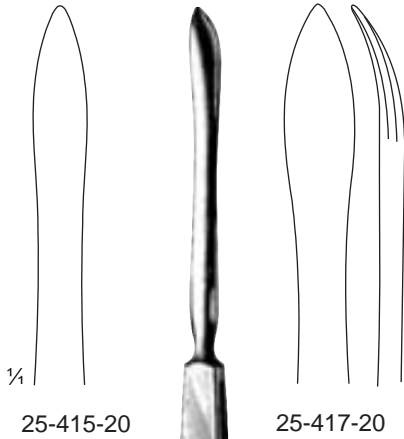
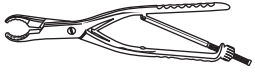

¼  
25-415-20

25-417-20

½  
**Langenbeck**

25-415-20 - 25-417-20  
20 cm / 8"

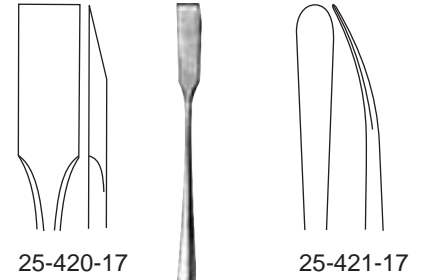

25-420-17

25-421-17

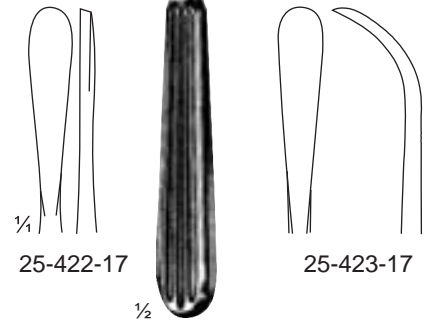

¼  
25-422-17

25-423-17

½  
**Adson**

25-420-17 - 25-423-17  
17 cm / 6¾"

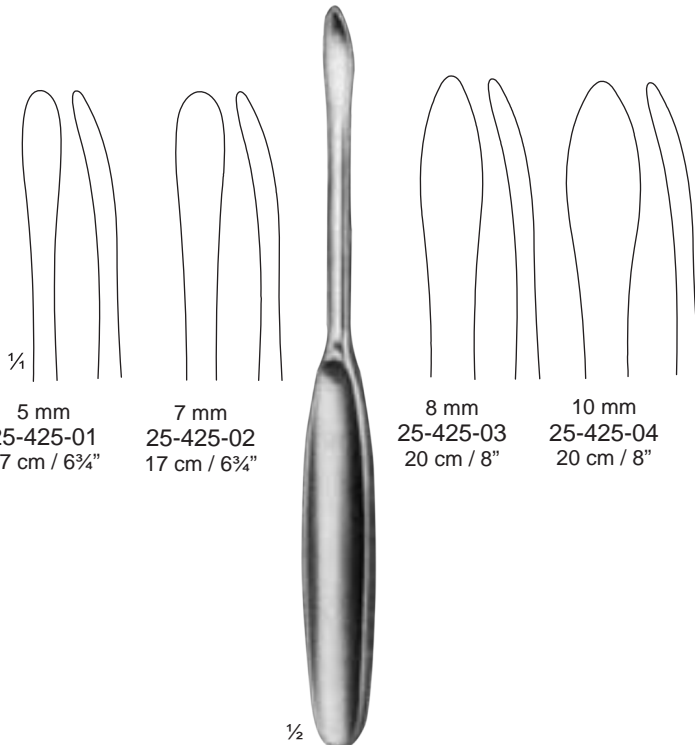

¼  
5 mm  
25-425-01  
17 cm / 6¾"

7 mm  
25-425-02  
17 cm / 6¾"

8 mm  
25-425-03  
20 cm / 8"

10 mm  
25-425-04  
20 cm / 8"

½  
**Langenbeck**

25-425-01 - 25-425-04

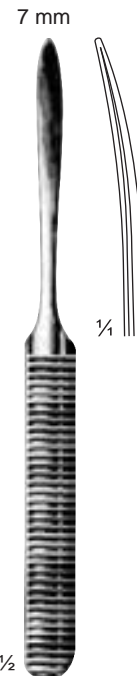

7 mm  
¼  
½  
**Williger**  
25-428-17  
17 cm / 6¾"

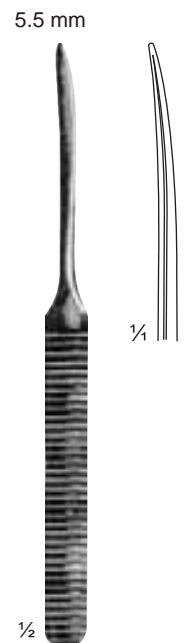

5.5 mm  
¼  
½  
**Williger**  
25-431-16  
16 cm / 6¼"

**Elevators**

Elevatorien  
Elevadores

Elévateurs  
Elevatori

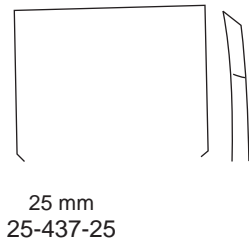

25-437-06 - 25-437-25  
19 cm / 7 1/2"



Micro-Elevator



25-450-16  
16 cm / 6 1/4"



extremely lightweight



25-452-17  
17.5 cm / 6 3/4"

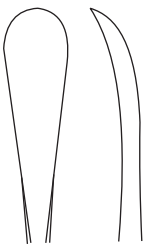

**Alderdyce**  
25-455-21  
21 cm / 8 1/4"

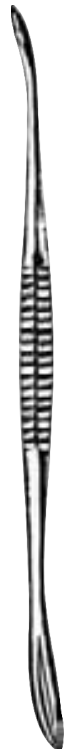

**Durham**  
25-458-18  
18 cm / 7"

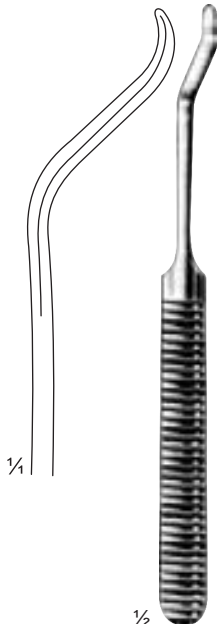

25-461-16  
16 cm / 6 1/4"



**London Hosp.**  
25-464-19  
19 cm / 7 1/2"



**McDonald**  
25-467-19  
19 cm / 7 1/2"  
blunt blunt



**Watson-Cheyne**  
25-469-17  
17.5 cm / 7"

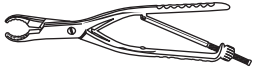

**Bone Levers**

Knochenhebel  
Elevadores para hueso

Leviers à os  
Elevatori per ossa

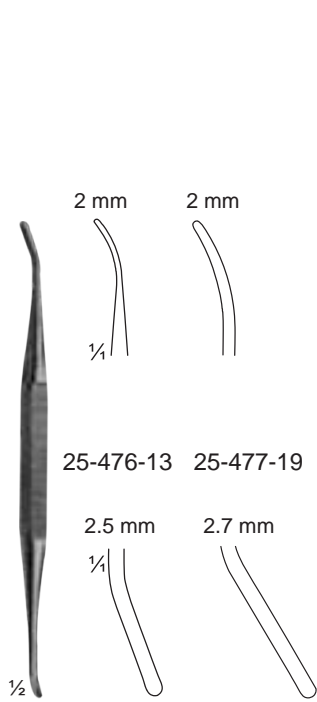

25-476-13 25-477-19

**Watson-Cheyne**  
25-476-13 = 13 cm / 5 1/8"  
25-477-19 = 19 cm / 7 1/2"



**Syme**  
25-481-18  
sharp  
18 cm / 7 1/4"

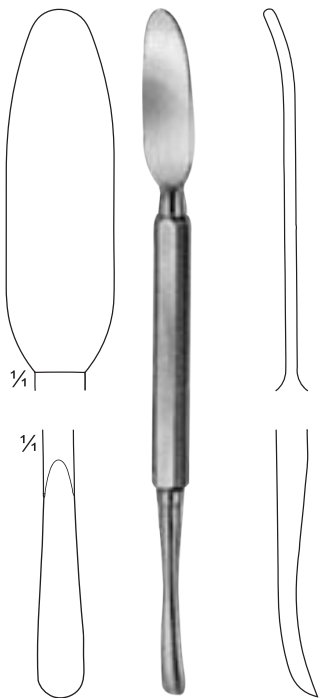

**Roberts**  
25-484-18  
sharp  
18.5 cm / 7 1/4"

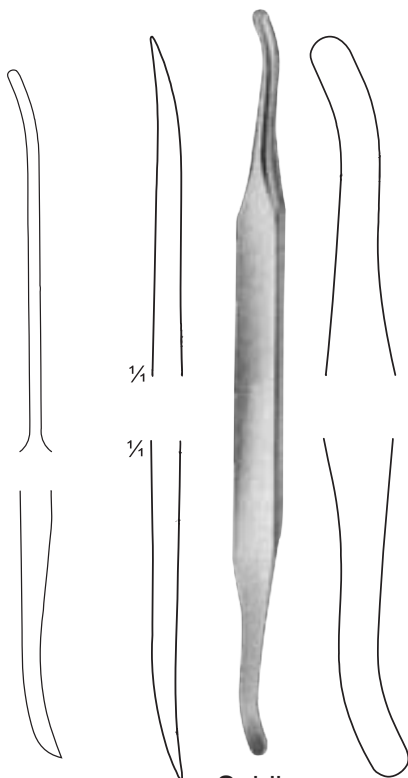

**Seldin**  
25-486-19  
19.5 cm / 7 3/4"

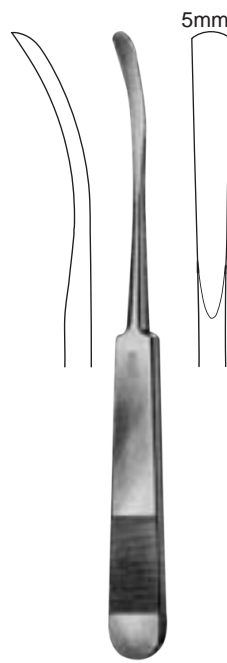

**Adson**  
25-489-16  
16.5 cm / 6 1/2"

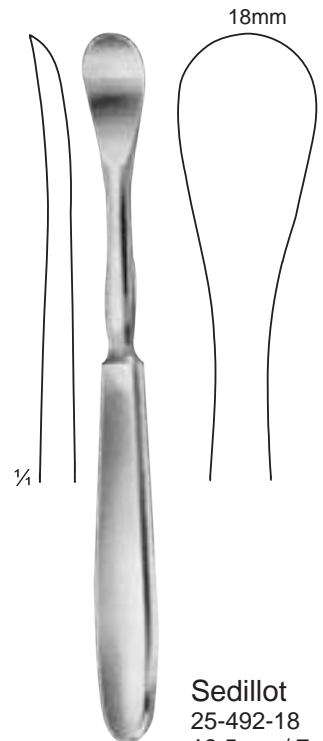

**Sedillot**  
25-492-18  
18.5 cm / 7 1/4"

**Bone Levers**

Knochenhebel  
Elevadores para hueso

Leviers à os  
Elevatori per ossa

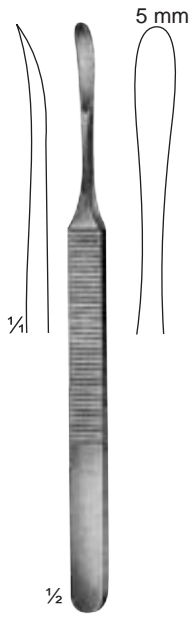
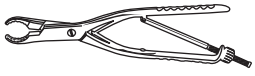

**König**  
25-501-15  
15.5 cm / 6"

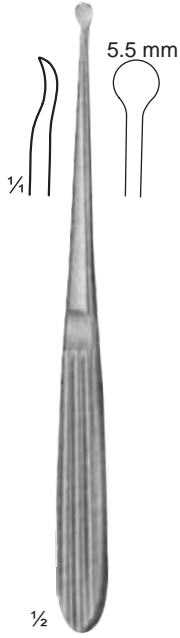

**Ward**  
25-504-17  
17 cm / 6 3/4"



**Trelat**  
25-507-15  
15 cm / 6"

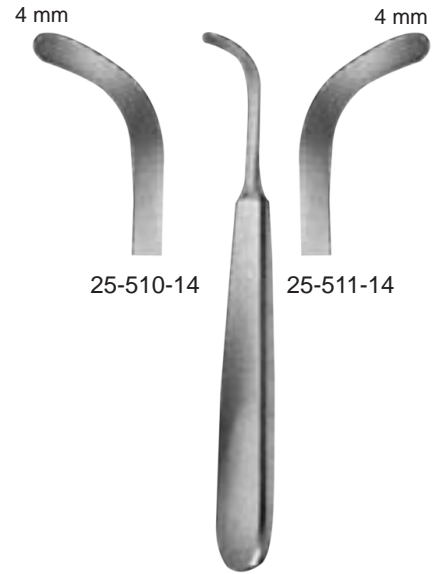

25-510-14 - 25-511-14  
14 cm / 5 1/2"



**Fickling**  
25-515-13  
13 cm / 5"

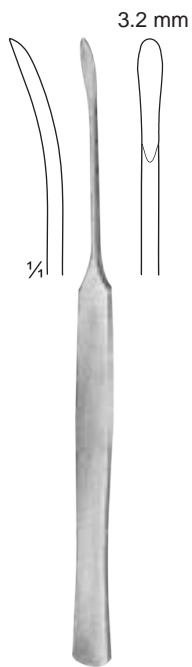

**Lempert**  
25-517-16  
16.5 cm / 6 1/2"

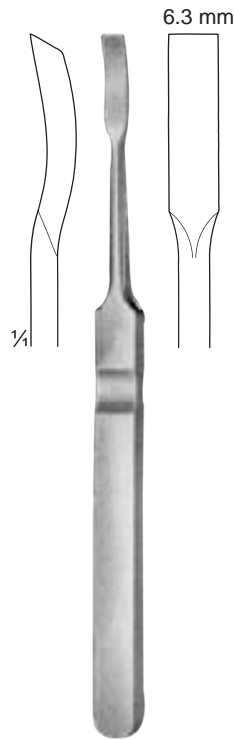

**Lempert**  
25-520-18  
18.5 cm / 7 1/4"



**ST Clair Thompson**  
25-523-16 sharp  
25-524-16 blunt  
16 cm / 6 1/4"



**Bone Levers**

Knochenhebel  
Elevadores para hueso

Leviers à os  
Elevatori per ossa

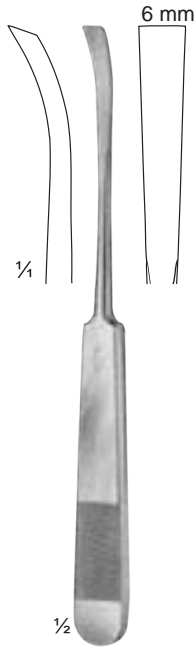

**Pennybaker**  
25-532-16  
16.5 cm / 6½"

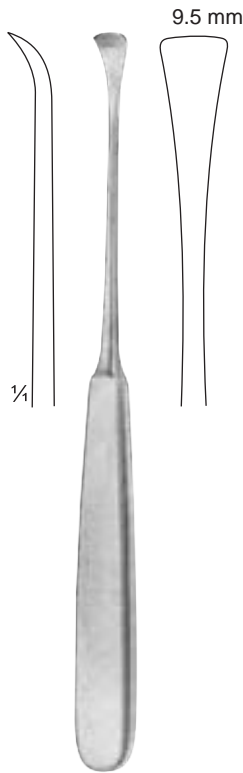

**Büchs**  
25-534-19  
19 cm / 7½"

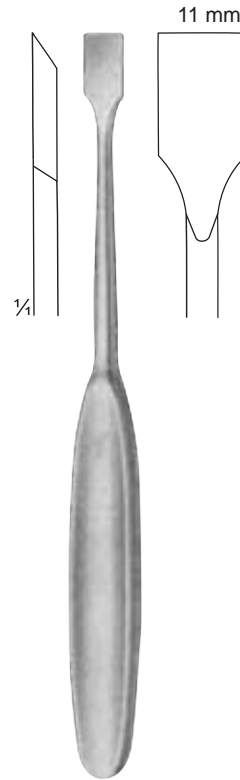

**Mckissock**  
25-537-19  
19.5 cm / 7¾"

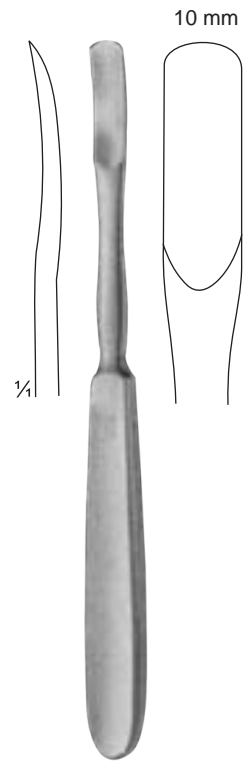

**Kramer**  
25-540-18  
18.5 cm / 7¼"

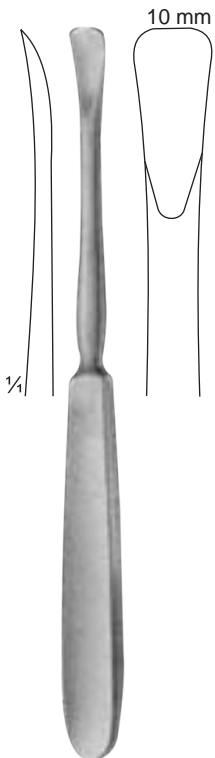

**Kramer**  
25-543-19  
19 cm / 7½"

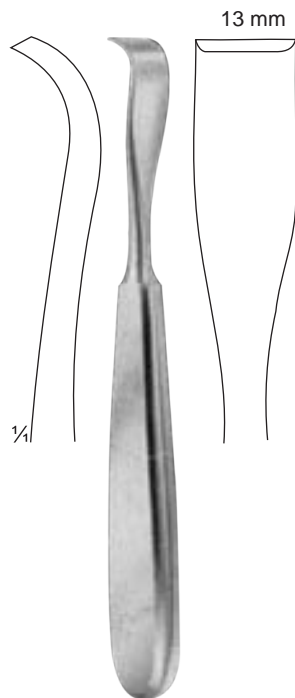

**Schneider**  
25-545-17  
17.5 cm / 7"

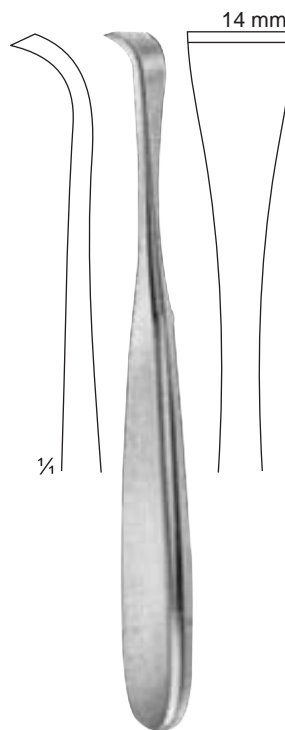

**Schneider-Sauerbruch**  
25-548-19  
19 cm / 7½"

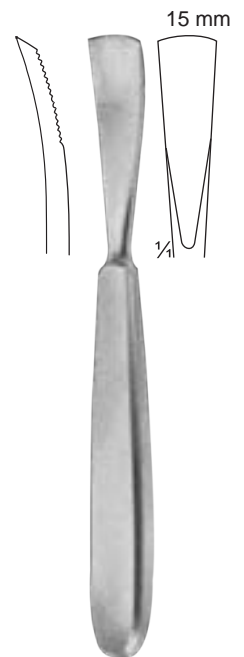

**Jansen**  
25-550-16  
16.5 cm / 6½"

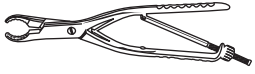

**Bone Levers**

Knochenhebel  
Elevadores para hueso

Leviers à os  
Elevatori per ossa



**Mitchells**  
25-556-21  
21 cm / 8½"



**Jones**  
25-559-17  
17 cm / 6¾"



**Cobb**  
25-562-29 = 10 mm  
25-563-29 = 13 mm  
25-564-29 = 19 mm  
spinal elevator  
29 cm / 11½"



**Lane**  
25-566-23  
23 cm / 9"



**Lane**  
25-569-23  
23 cm / 9"



**Lane**  
25-571-27  
27 cm / 10½"



**Lane**  
25-574-36  
36 cm / 14"

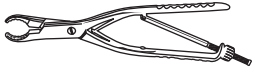

**Bone Levers**

Knochenhebel  
Elevadores para hueso

Leviers à os  
Elevatori per ossa



12 mm

1/2

**Täger**  
25-580-17  
17.5 cm / 7"



1/2

**Lane Trethowan**  
25-583-21  
21.5 cm / 8½"



1/2

**Lane**  
25-586-25  
25.5 cm / 10"



1/2

**Bristow**  
25-588-23  
23 cm / 9"



1/2

**Waston-Jones**  
25-590-28  
28 cm / 11"



1/2

**Murphy-Lane**  
25-593-34  
34 cm / 13½"



**Bone Levers**

Knochenhebel  
Elevadores para hueso

Leviers à os  
Elevatori per ossa

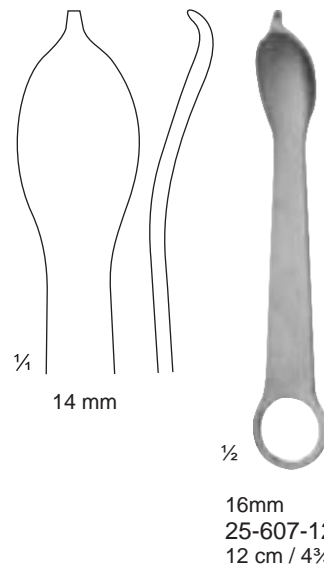
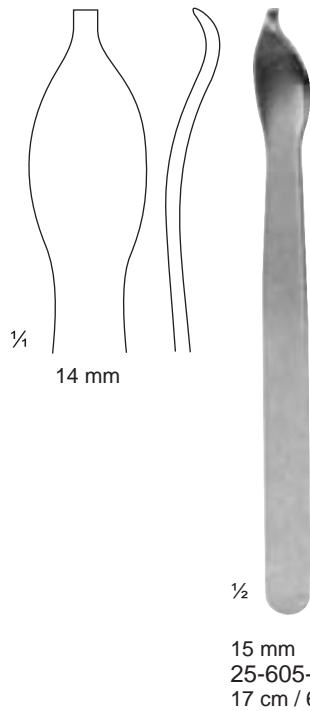
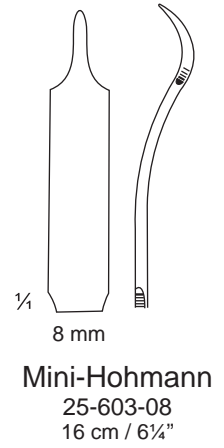
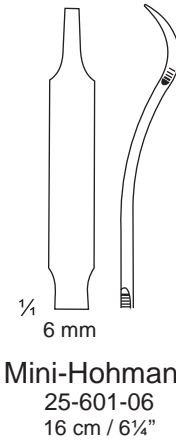
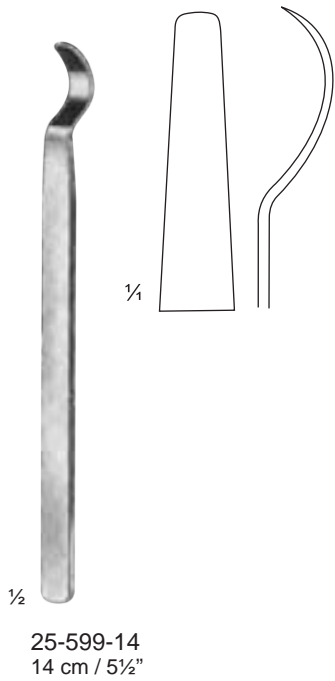

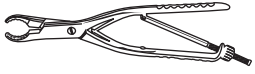

**Bone Levers**

Knochenhebel  
Elevadores para hueso

Leviers à os  
Elevatori per ossa

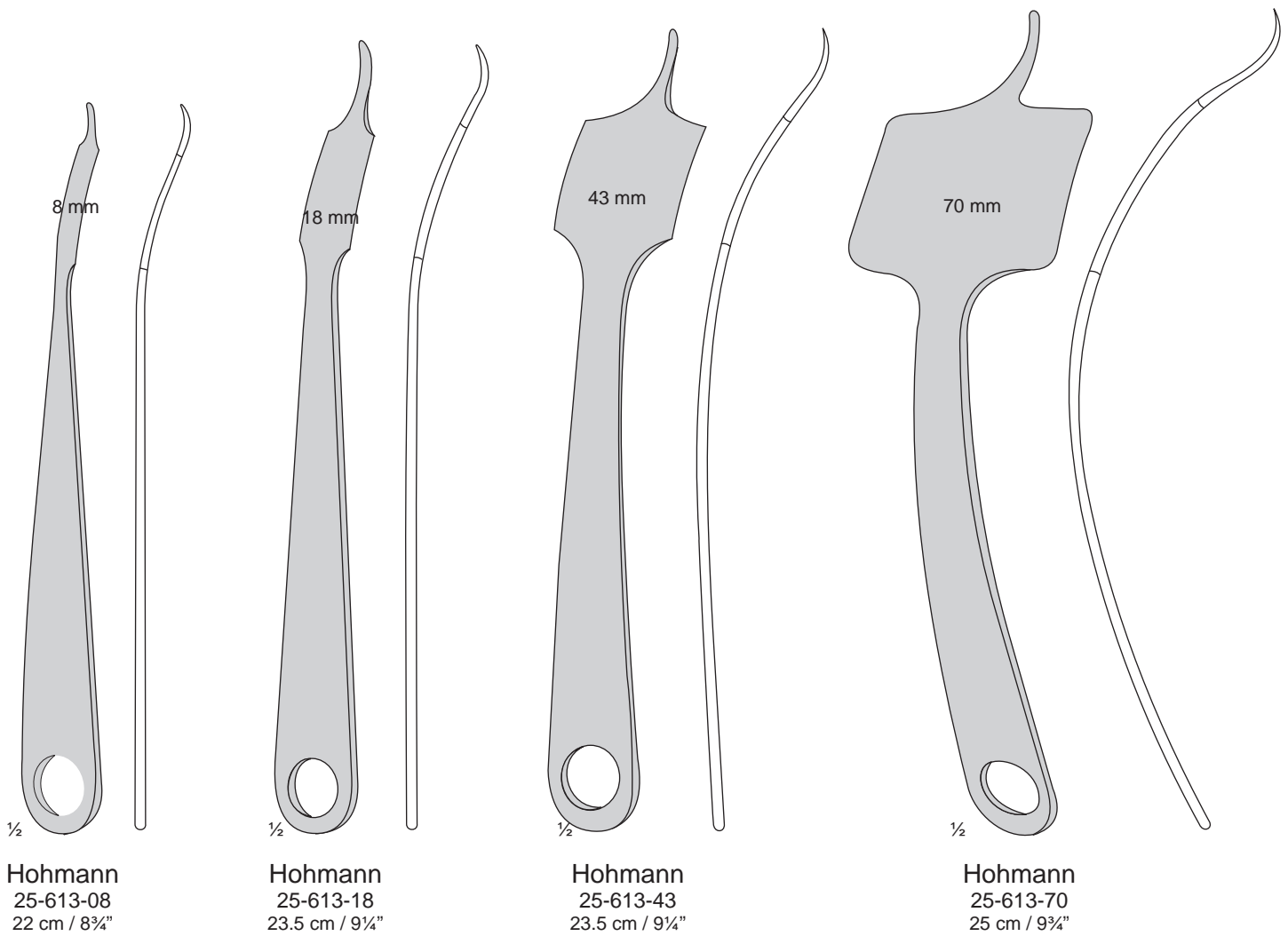

Hohmann  
25-613-08  
22 cm / 8 3/4"

Hohmann  
25-613-18  
23.5 cm / 9 1/4"

Hohmann  
25-613-43  
23.5 cm / 9 1/4"

Hohmann  
25-613-70  
25 cm / 9 3/4"



**Bone Levers**

Knochenhebel  
Elevadores para hueso

Leviers à os  
Elevatori per ossa

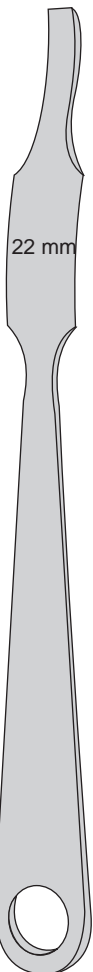

1/2  
**Lange-Hohmann**  
25-619-22  
25 cm / 9 3/4"

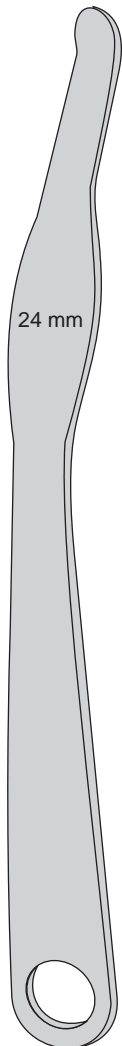

1/2  
**Lange-Hohmann**  
25-621-24  
27.5 cm / 10 3/4"

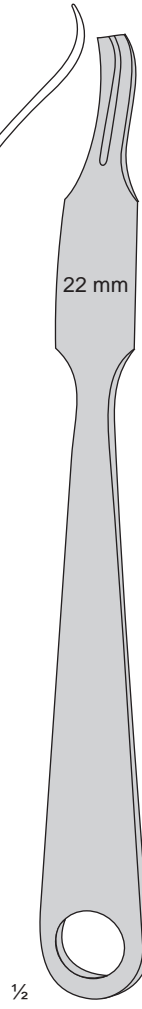

1/2  
**Hohmann**  
25-623-22  
25.5 cm / 10"

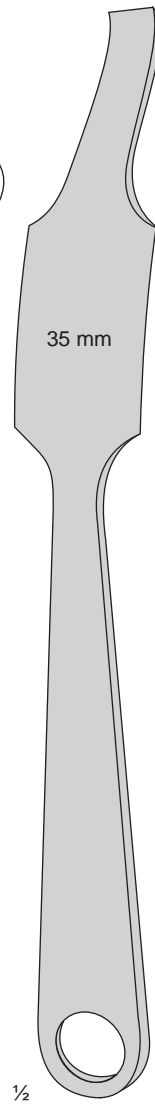

1/2  
**Hohmann**  
25-623-35  
29 cm / 11 1/2"

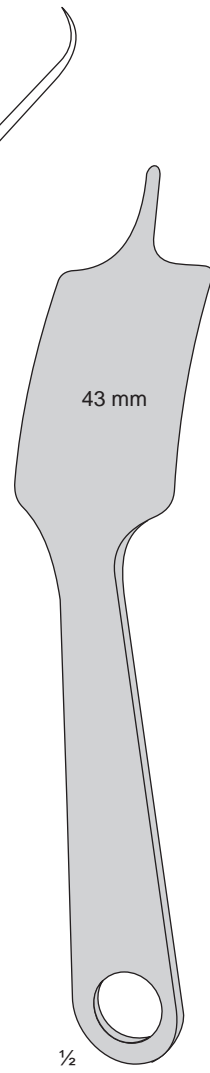

1/2  
**Hohmann**  
25-625-43  
23.5 cm / 9 1/4"

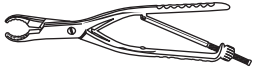

**Bone Levers**

Knochenhebel  
Elevadores para hueso

Leviers à os  
Elevatori per ossa

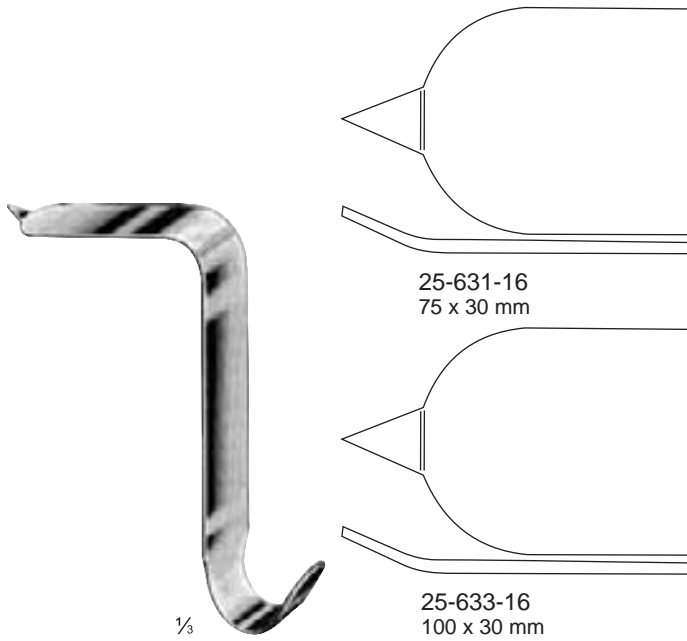

**Taylor**  
25-631-16 - 25-633-16  
16.5 cm / 6½"

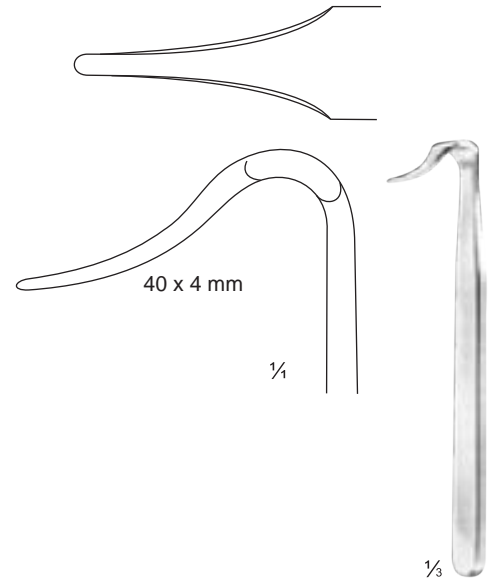

**Blount**  
25-635-17  
17.5 cm / 7"



**Bennett**  
25-637-24  
24 cm / 9½"



**Blount**  
25-639-26  
26 cm / 10¼"



**Blount**  
25-641-26  
26 cm / 10¼"



### Knee Retractors

Wund-und Meniskushaken  
Separadores para rodilla

Ecarteurs pour le genou  
Divaricatori per il ginocchio

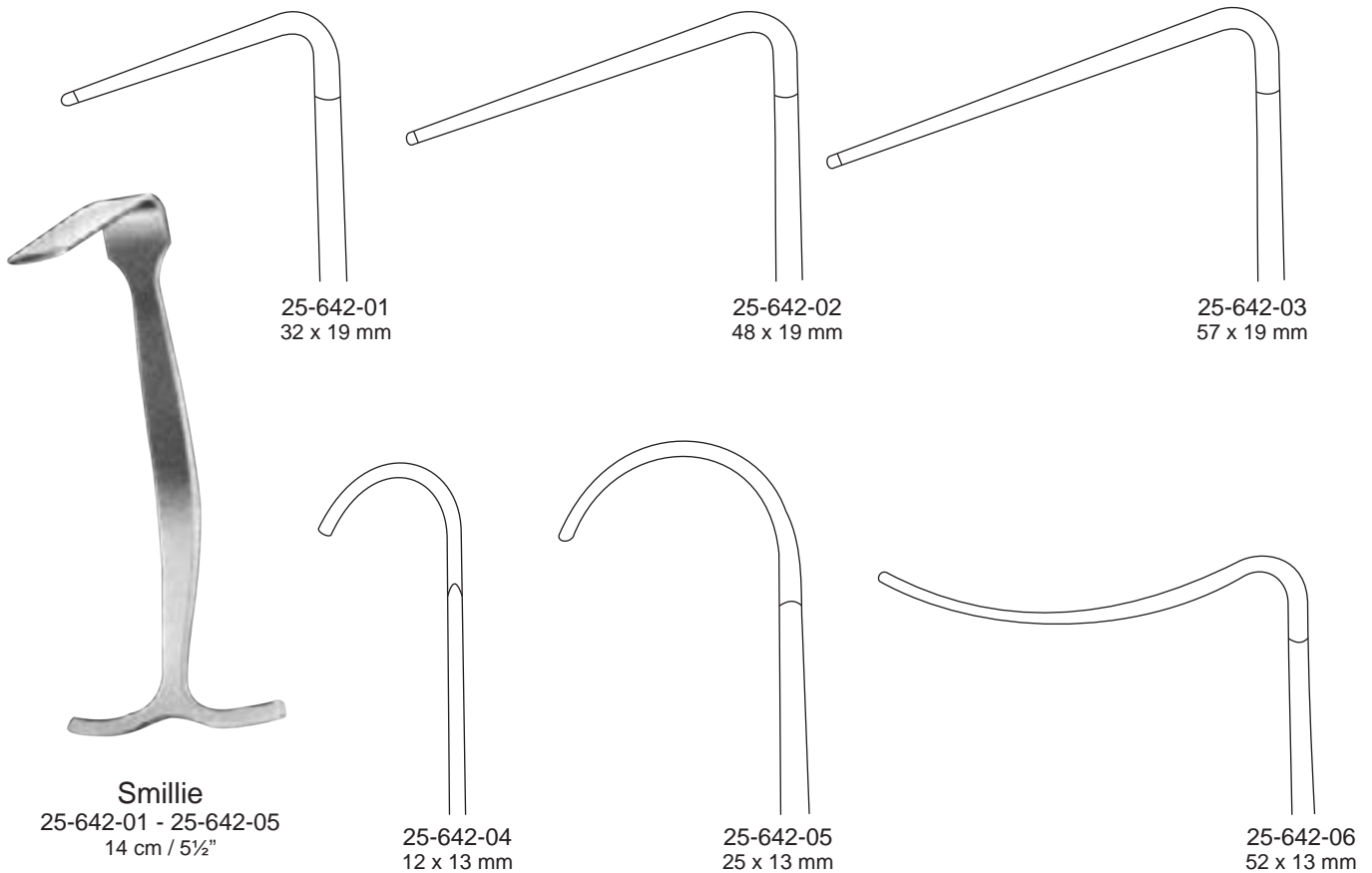



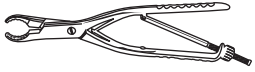

**Meniscus Knives**

Meniskotome, Meniskusmesser  
Cuchillos para menisco

Bistouris à ménisque  
Meniscotomi

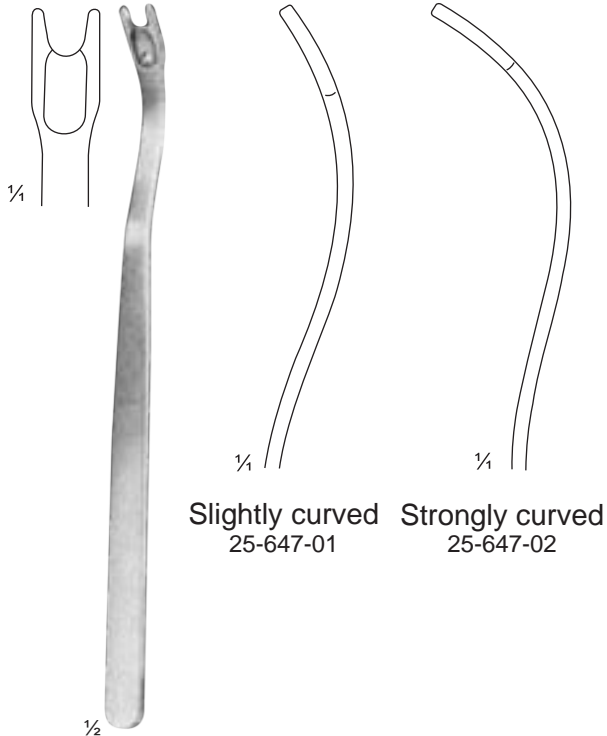

¼  
25-647-24  
Spare Blades,

Slightly curved 25-647-01  
Strongly curved 25-647-02

½  
**Stryker-Scholl**  
25-647-01 - 25-647-02  
19 cm / 7½"

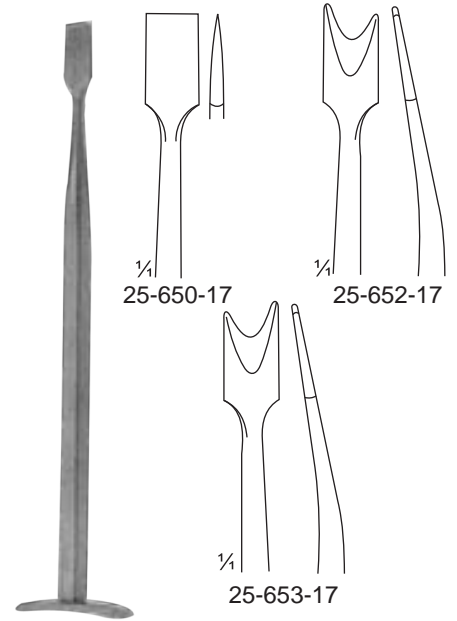

½  
**Smillie**  
25-650-17 - 25-653-17  
17 cm / 6¾"

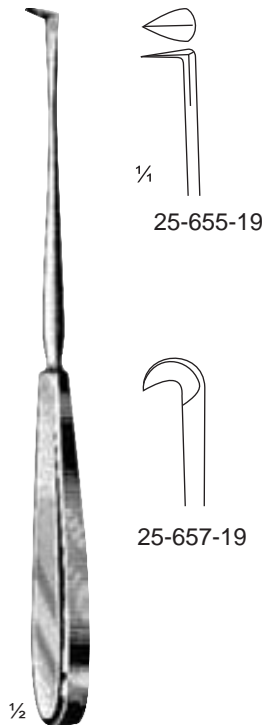

½  
**Bircher**  
25-655-19 - 25-657-19  
19 cm / 7½"

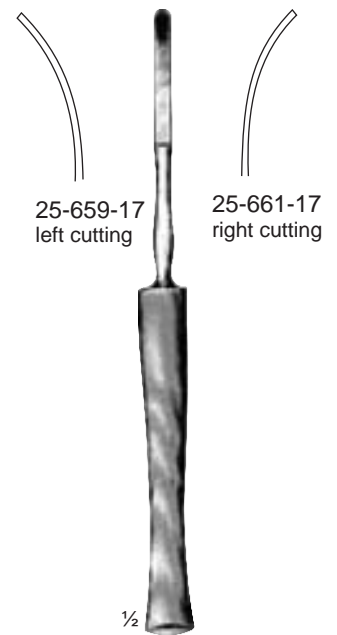

½  
**Mod. Schweden**  
25-659-17 - 25-661-17  
17 cm / 6¾"

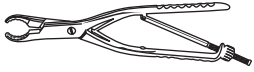

**Meniscus Knives**

Meniskotome, Meniskusmesser  
Cuchillos para menisco

Bistouris à ménisque  
Meniscotomi

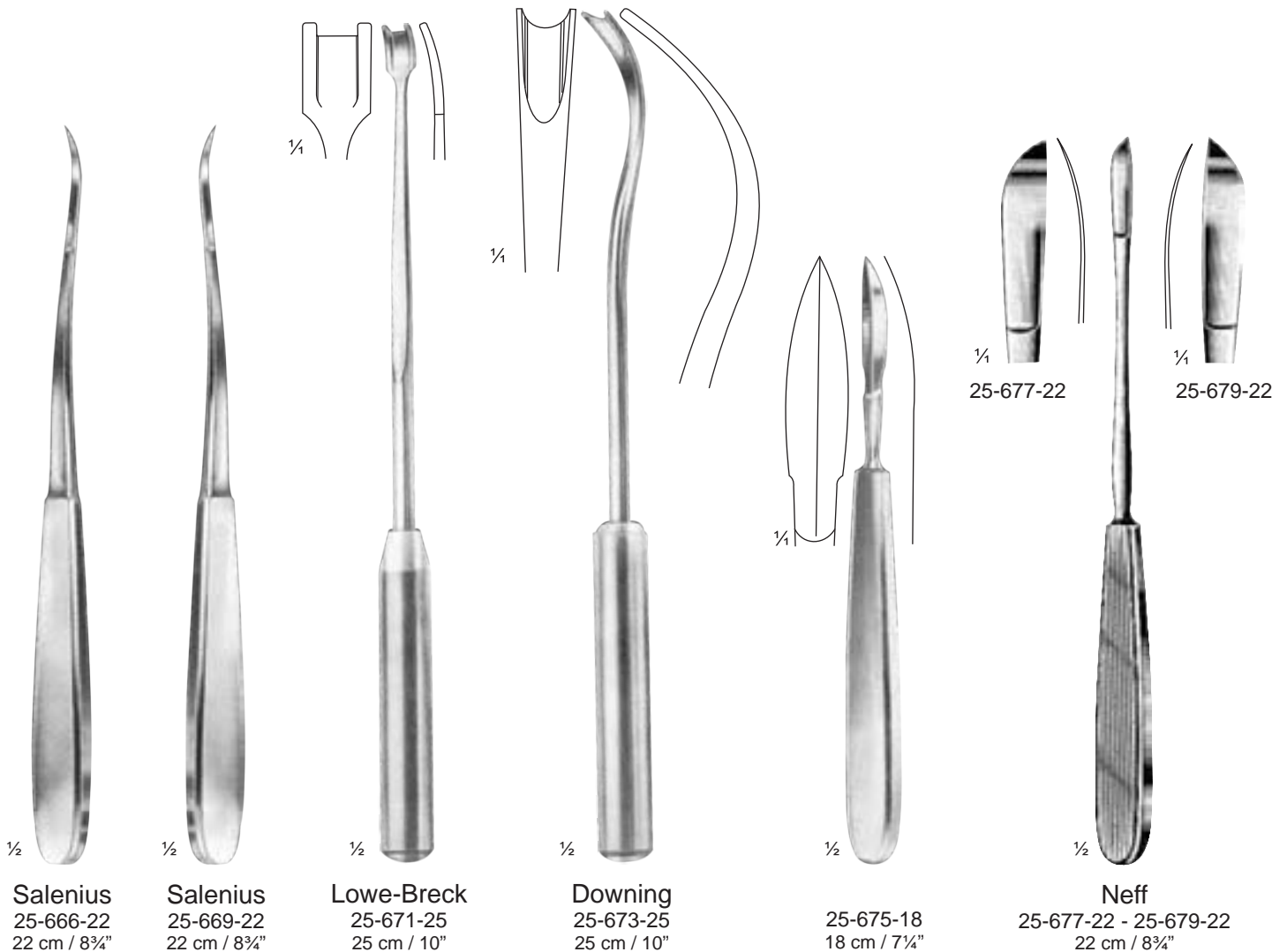

1/2  
**Salenius**  
25-666-22  
22 cm / 8 3/4"

1/2  
**Salenius**  
25-669-22  
22 cm / 8 3/4"

1/2  
**Lowe-Breck**  
25-671-25  
25 cm / 10"

1/2  
**Downing**  
25-673-25  
25 cm / 10"

1/2  
**25-675-18**  
18 cm / 7 1/4"

1/2  
**Neff**  
25-677-22 - 25-679-22  
22 cm / 8 3/4"



### Tendon Strippers

Sehnenstripper  
Enucleadores de tendones

Instruments à écorcher les tendons  
Scollatendini

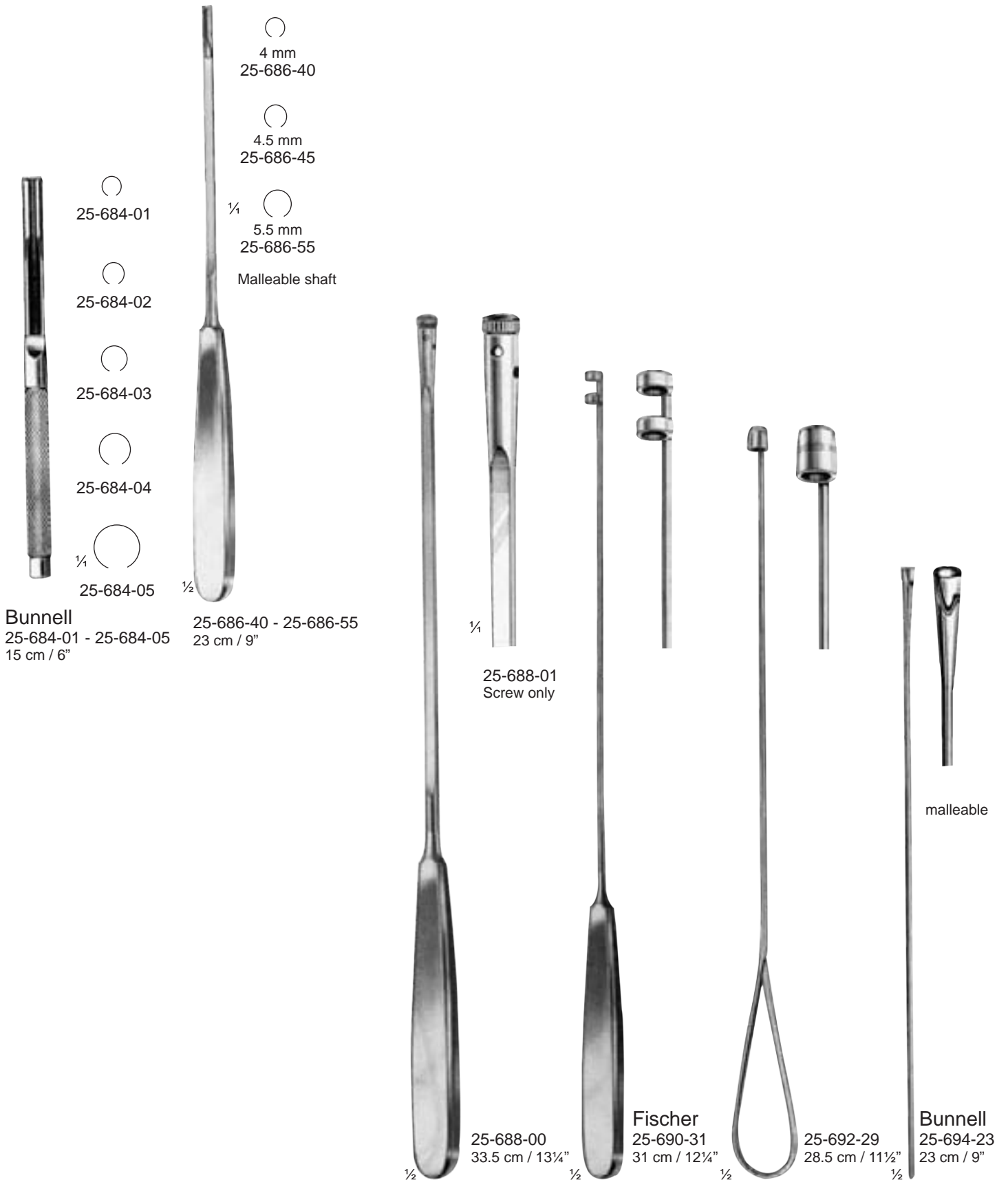



### Tendon Holding Forceps, Tendon Tunnelling Forceps

Sehnenfasszangen, Sehnedurchzugzangen  
Pinzas para coger tendones, Pinzas para pasar tendones

Pinces pour saisir les tendons, Pinces pour passer les tendons  
Pinze per afferrare tendini, Pinze passa-tendini



**Steinmann**  
25-698-16  
16 cm / 6¼"

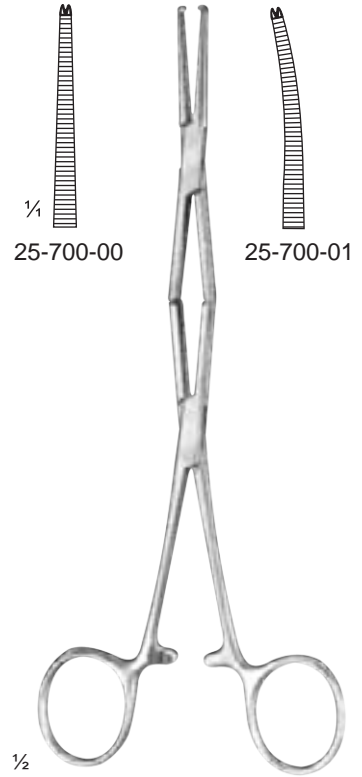

25-700-00 - 25-700-01  
20.5 cm / 8"

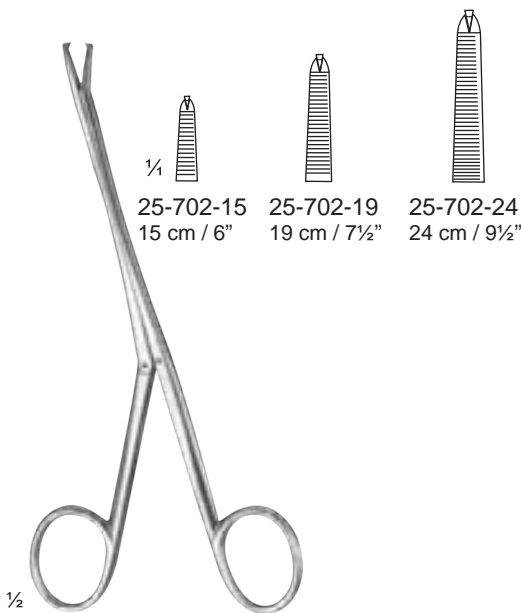

**Brand**  
25-702-15 - 25-702-24

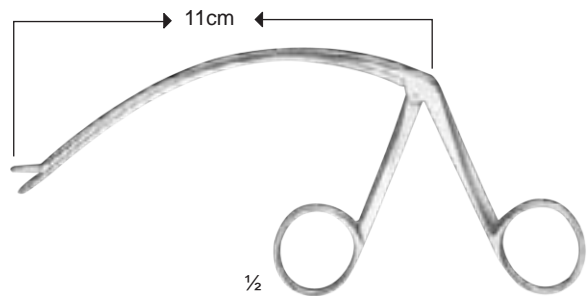

**Carroll**  
25-705-11  
11.5 cm / 4½"



### Tendon Holding Forceps, Tendon Interlacing Forceps

Sehnenfasszangen, Sehneneinflechtzangen  
 Pinzas para coger tendones, Pinzas para entrelazar tendones

Pinces pour saisir les tendons, pincettes pour entrelacer les tendons  
 Pinze per afferrare tendini, Pinze per allacciare tendini

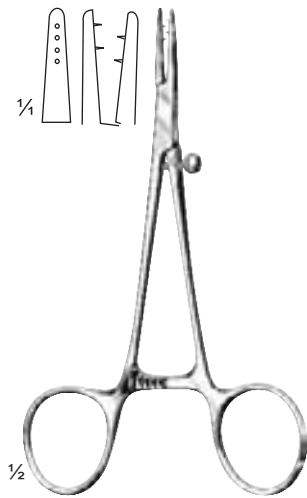

25-710-13  
 13 cm / 5"



Kleinert-Kutz  
 25-713-20  
 20 cm / 8"

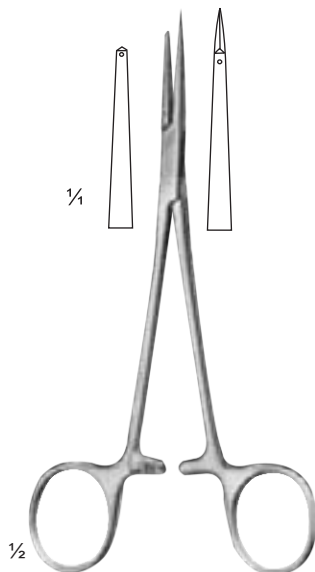

25-716-15  
 15 cm / 6"

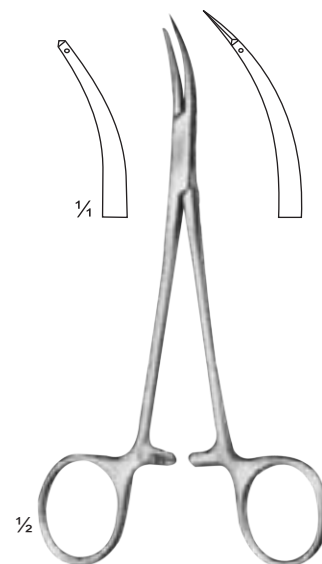

25-719-15  
 15 cm / 6"



**Cartilage Seizing Forceps**

Knorpelfasszangen  
Pinzas para cartilago

Pinces à cartilage  
Pinze per cartilagine

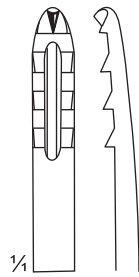

25-724-20

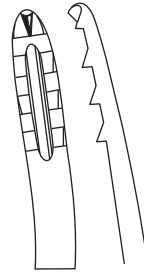

25-725-20  
curved upwards

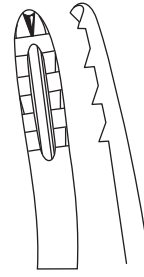

25-727-20  
curved sideways

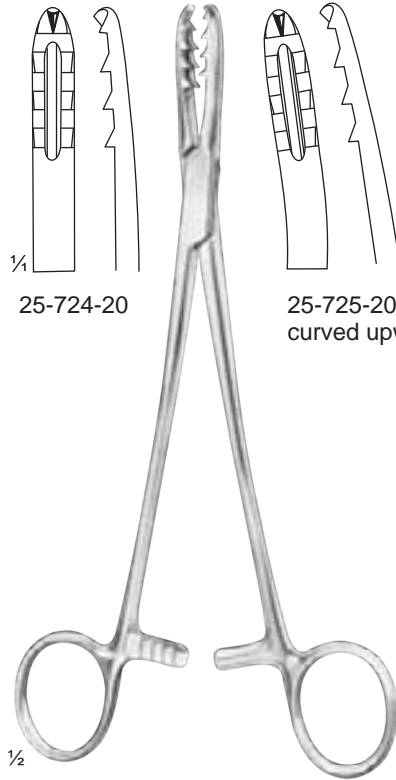

1/2

**Bircher-Ganske**  
25-724-20 - 25-727-20  
20 cm / 8"

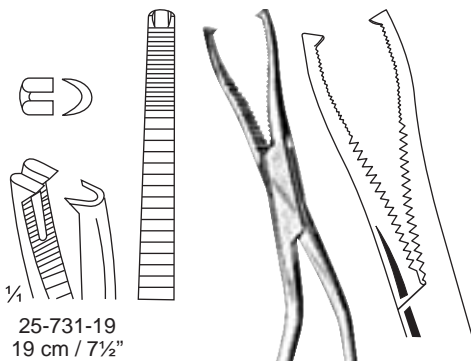

25-731-19  
19 cm / 7 1/2"

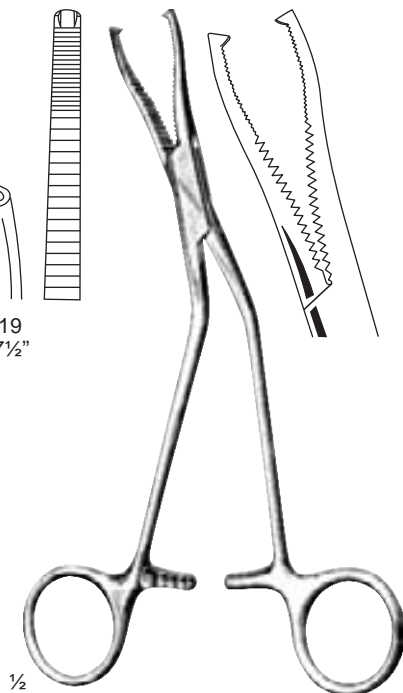

1/2

**Dingmann**  
25-729-19  
19 cm / 7 1/2"

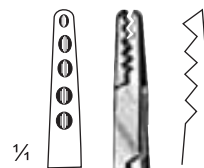

1/2



**Martin**  
25-732-19  
19 cm / 7 1/2"

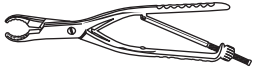

**Reposition Forceps, Bone Holding Forceps**

Repositionszangen, Knochenhaltezangen  
Pinzas para reposición, Pinzas para hueso

Pinces à réduction, Daviers porte-os  
Pinze per riposizioni, Tenaglie per ossa

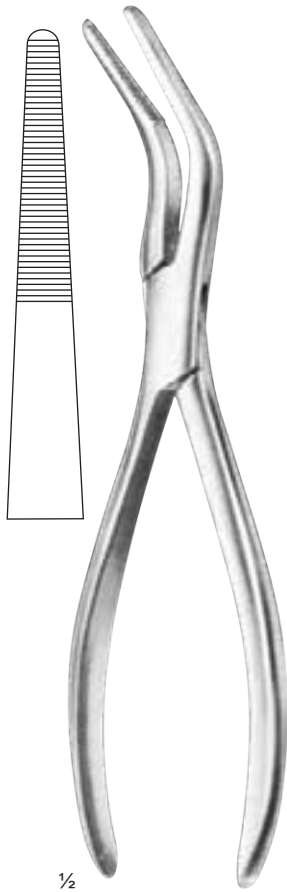

1/2  
**Van Buren**  
25-735-23  
23 cm / 9"

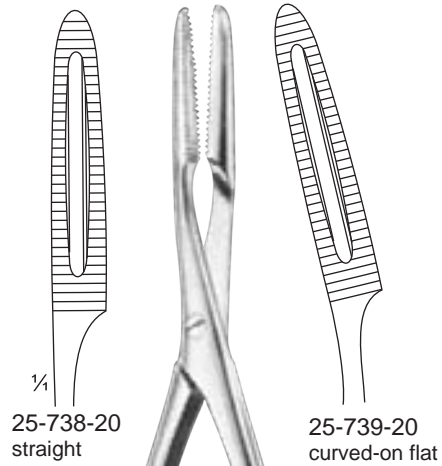

1/4  
25-738-20  
straight

25-739-20  
curved-on flat

1/2  
**Sequestrum**  
25-738-20 - 25-739-20  
20 cm / 8"

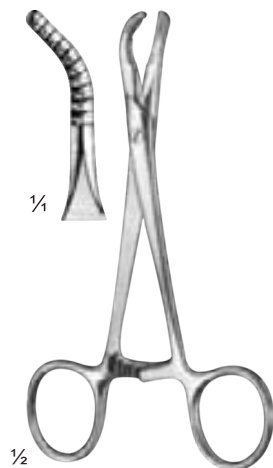

1/4  
1/2  
**25-742-14**  
13.5 cm / 5 1/4"



1/4  
1/2  
**25-745-12**  
13.5 cm / 5 1/4"



**Reposition Forceps, Bone Holding Forceps**

Repositionszangen, Knochenhaltezangen  
Pinzas para reposición, Pinzas para hueso

Pinces à réduction, Daviers porte-os  
Pinze per riposizioni, Tenaglie per ossa

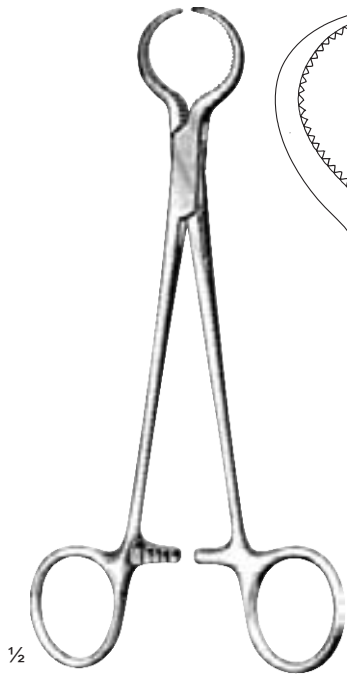

**Lewin**  
25-748-18  
18.5 cm / 7¼"

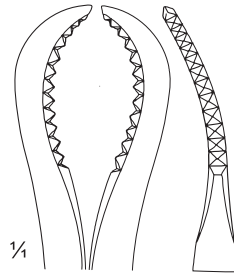

25-749-17  
17 cm / 6¾"

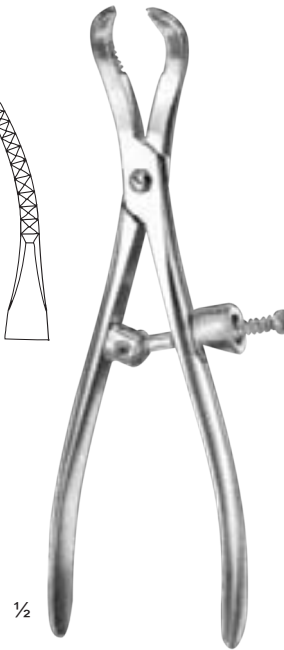

25-749-24  
24 cm / 9½"

25-749-17 - 25-749-24

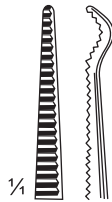

25-750-14  
14 cm 5½"



25-751-14  
13.5 cm / 5¼"

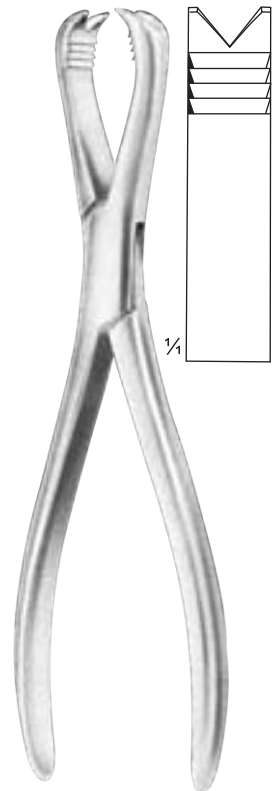

**Langenbeck**  
25-752-21  
21 cm / 8¼"



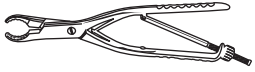

**Bone Holding Forceps**

Knochenhaltezaugen  
Pinzas para hueso

Daviers porte-os  
Tenaglie per ossa

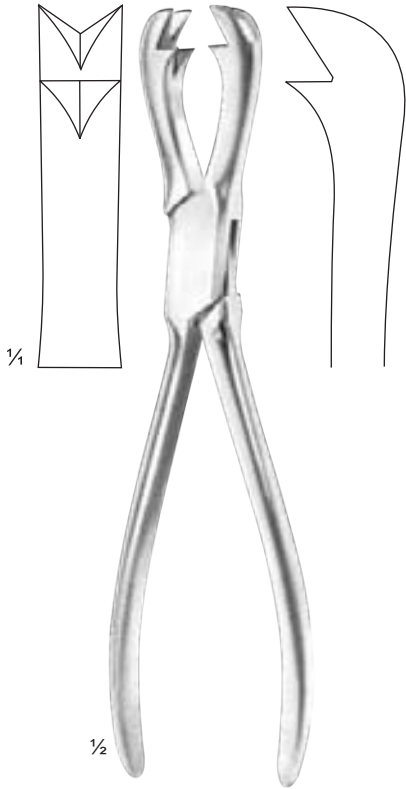

**Fergusson**  
25-756-21  
21 cm / 8 1/4"



**Frosch**  
25-758-18  
18 cm / 7"

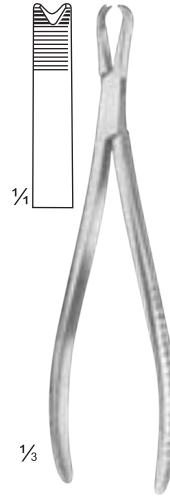

25-759-20  
20 cm / 8"

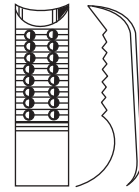

25-760-15  
15 cm / 6"  
without ratchet

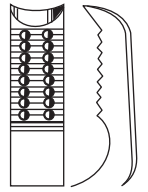

25-760-17  
17 cm / 6 3/4"  
without ratchet



25-760-21  
21 cm / 8 1/4"  
without ratchet

**Kern**  
25-760-15 - 25-760-21

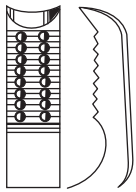

25-762-15  
15 cm / 6"  
with ratchet

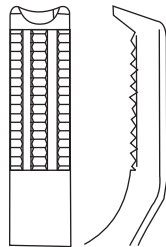

25-762-21  
21 cm / 8 1/4"  
with ratchet

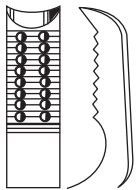

25-762-17  
17 cm / 6 3/4"  
with ratchet

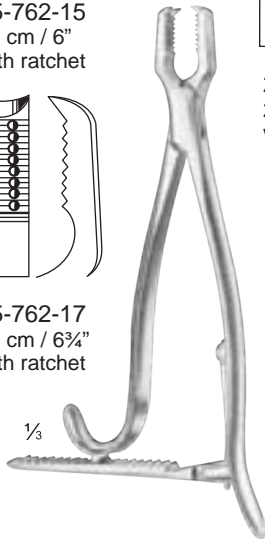

**Kern**  
25-762-15 - 25-762-21



25-763-19  
19 cm / 7 1/2"

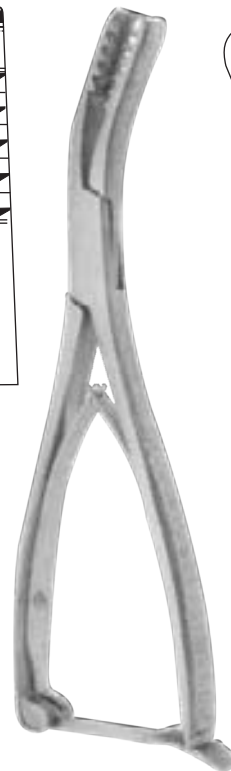

**Semb**  
25-764-19  
19 cm / 7 1/2"

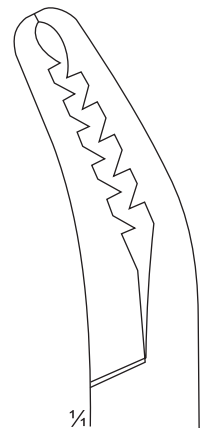

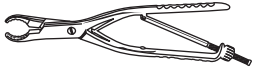

**Bone Holding Forceps**

Knochenhalte­zangen  
Pinzas para hueso

Daviers porte-os  
Tenaglie per ossa

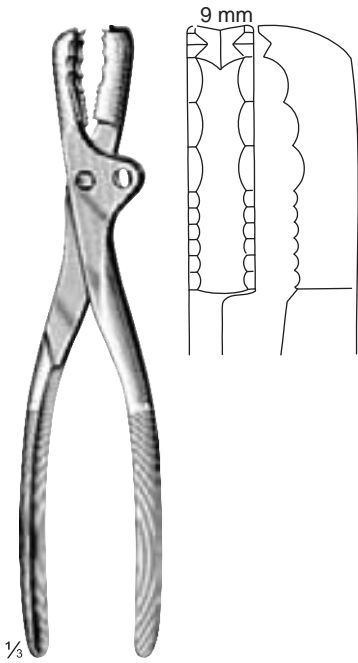

**Farabeuf**  
25-768-23 = 23 cm / 9"  
25-768-26 = 26 cm / 10 1/4"

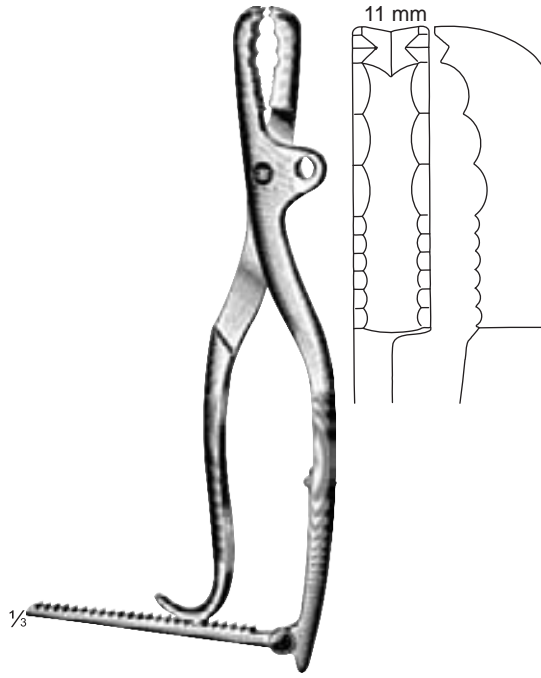

**Farabeuf-Lambotte**  
25-770-26  
26 cm / 10 1/4"

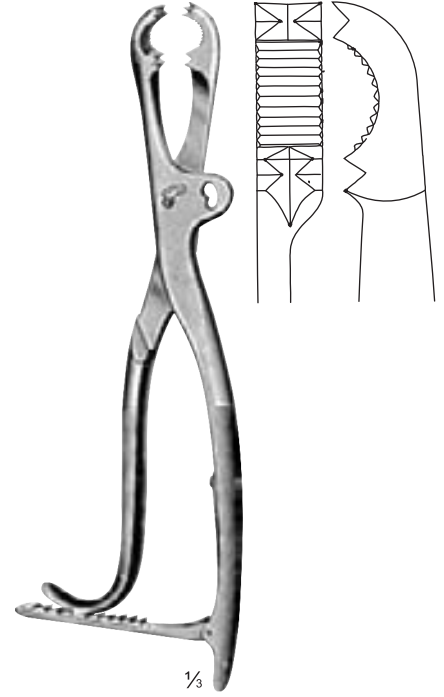

**Tuffier**  
25-772-27  
27 cm / 10 1/2"

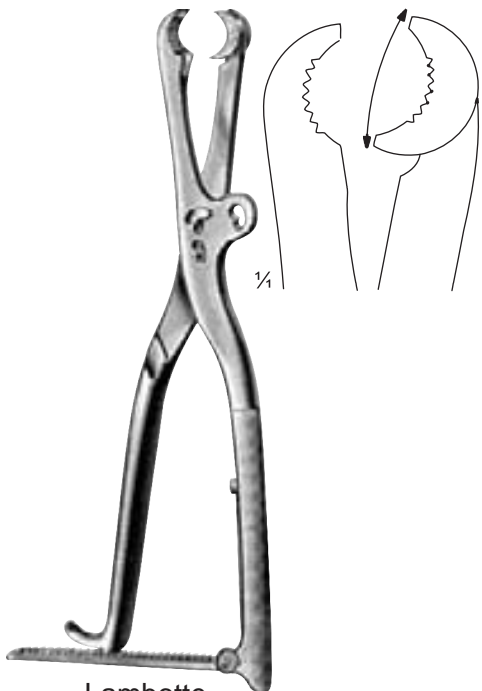

**Lambotte**  
25-774-22 = 22 cm / 8 3/4"  
25-774-27 = 27 cm / 10 1/2"  
25-774-30 = 30 cm / 12"

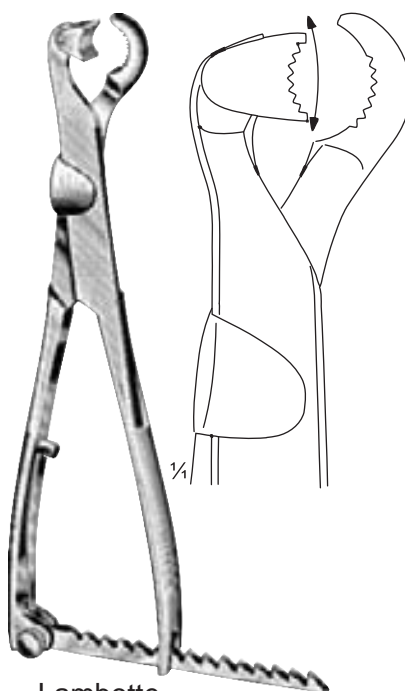

**Lambotte**  
25-776-22 = 22 cm / 8 3/4"  
25-776-26 = 26 cm / 10 1/4"  
25-776-33 = 33 cm / 13"

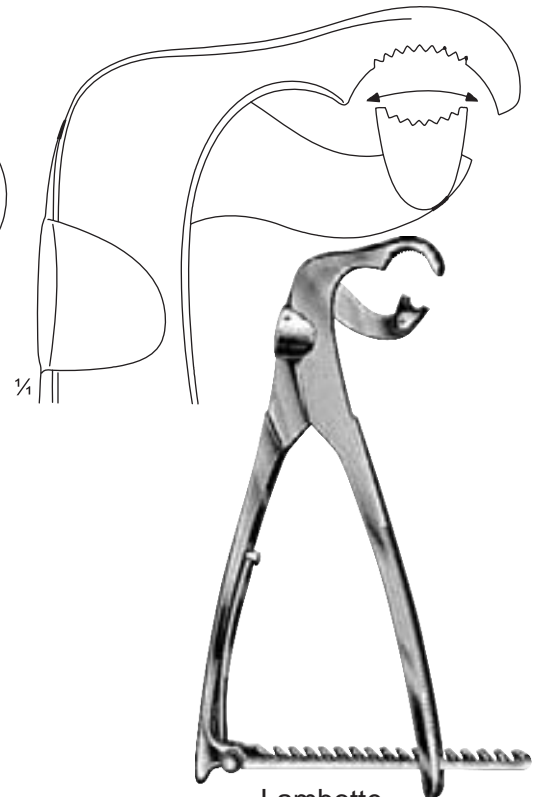

**Lambotte**  
25-779-19 = 19 cm / 7 1/2"  
25-779-23 = 23 cm / 9"  
25-779-26 = 26 cm / 10 1/4"

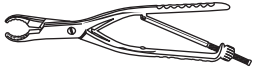

**Bone Holding Forceps**

Knochenhalte­zangen  
Pinzas para hueso

Daviers porte-os  
Tenaglie per ossa

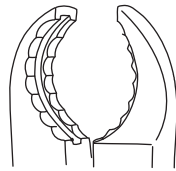

25-782-23  
25-783-23  
23 cm / 9"

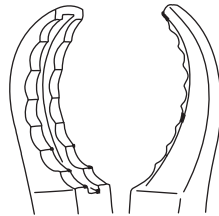
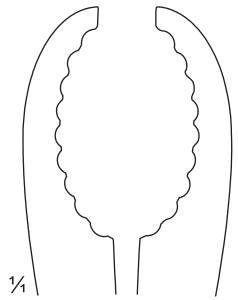

25-782-25  
25-783-25  
25 cm / 10"

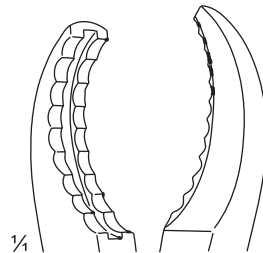
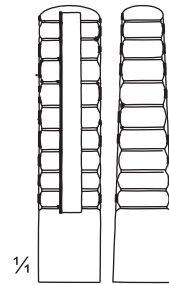

25-782-28  
25-783-28  
28 cm / 11"



Ulrich  
25-782-23 - 25-782-28



Ulrich  
25-783-23 - 25-783-28



**Reposition Forceps, Bone Holding Forceps**

Repositionszangen, Knochenhalte­zangen  
Pinzas para reposición, Pinzas para hueso

Pinces à réduction, Daviers porte-os  
Pinze per riposizioni, Tenaglie per ossa

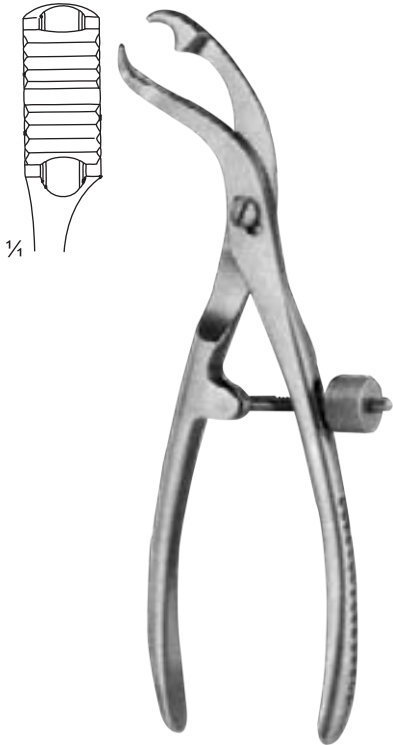

25-785-15 - 25-785-28  
Self Centering Forceps

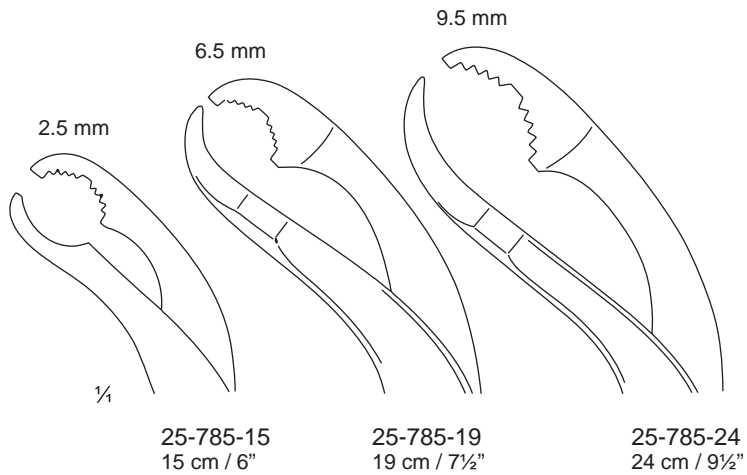

25-785-15  
15 cm / 6"

25-785-19  
19 cm / 7½"

25-785-24  
24 cm / 9½"

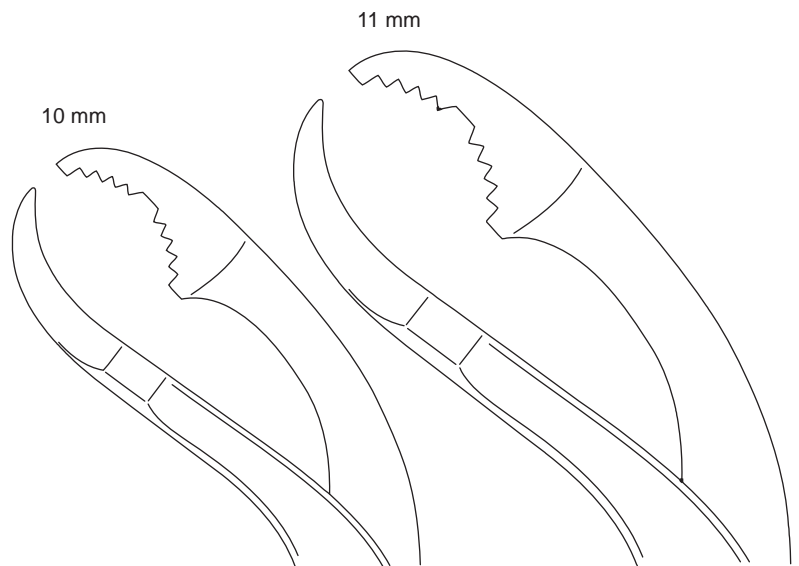

25-785-26  
26 cm / 10¼"

25-785-28  
28 cm / 11"

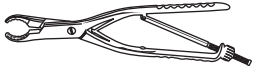

**Bone Holding Forceps**

Knochenhalte­zangen  
Pinzas para hueso

Daviers porte-os  
Tenaglie per ossa



Lane  
25-788-33 - 25-790-45

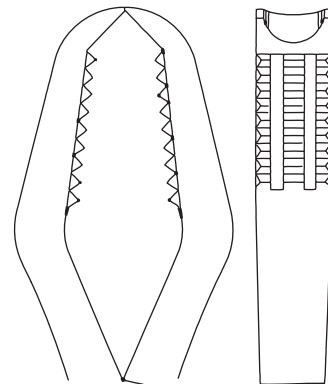

25-788-33 = 33 cm / 13"  
without ratchet  
25-790-33 = 33 cm / 13"  
with ratchet

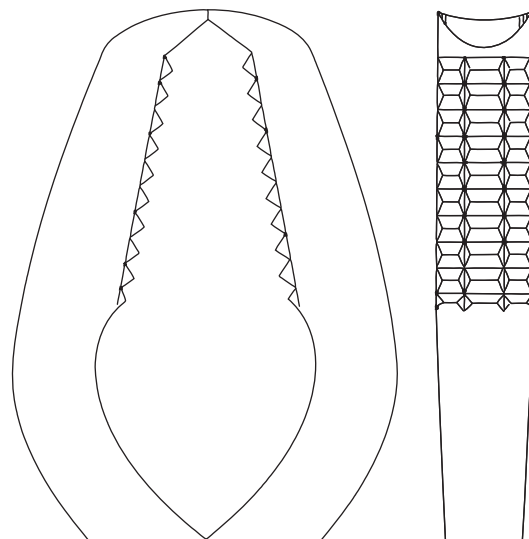

25-788-45 = 45 cm / 17¼"  
without ratchet  
25-790-45 = 45 cm / 17¼"  
with ratchet



**Bone Holding Forceps**

Knochenhalte­zangen  
Pinzas para hueso

Daviers porte-os  
Tenaglie per ossa



25-797-27  
27 cm / 10¾"



25-798-30  
30.5 cm / 12"

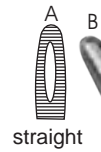

straight



**Fergusson**  
25-792-15 = 15 cm / 6"  
25-793-20 = 20 cm / 8"



**Lane**  
25-794-32 = 32 cm / 12½"  
25-795-39 = 39 cm / 15½"



**Hey Groves**  
25-796-21  
21 cm / 8¼"



**Sequestrum**  
25-800-20 = A = 20 cm / 8"  
25-801-20 = B = 20 cm / 8"

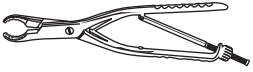

### Bone Holding Forceps

Knochenhaltezaugen  
Pinzas para hueso

Daviers porte-os  
Tenaglie per ossa

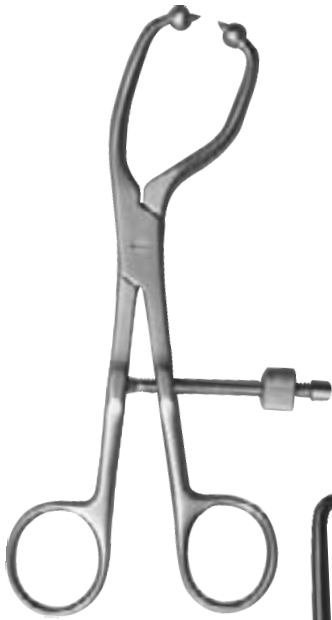

25-802-19  
19 cm / 7½"

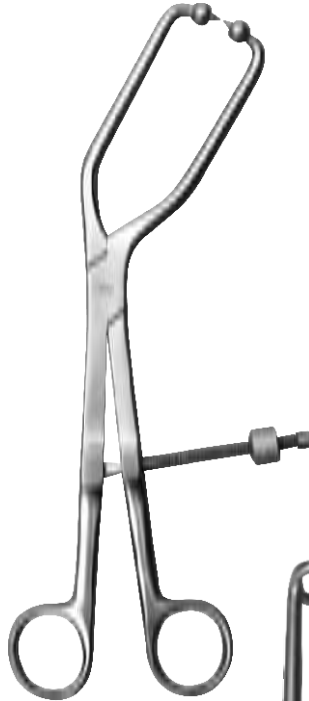

25-803-23  
23 cm / 9"

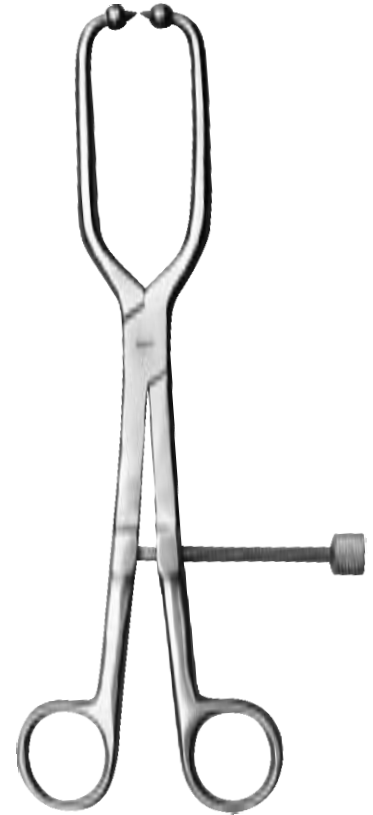

25-804-25  
25 cm / 10"



25-805-40  
40 cm / 15¾"



25-806-40  
40 cm / 15¾"



**Reposition Forceps, Bone Holding Forceps**

Repositionszangen, Knochenhaltezangen  
Pinzas para reposición, Pinzas para hueso

Pinces à réduction, Daviers porte-os  
Pinze per riposizioni, Tenaglie per ossa

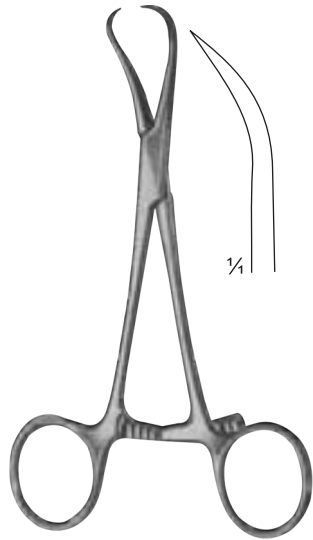

25-813-13  
13 cm / 5 1/8"

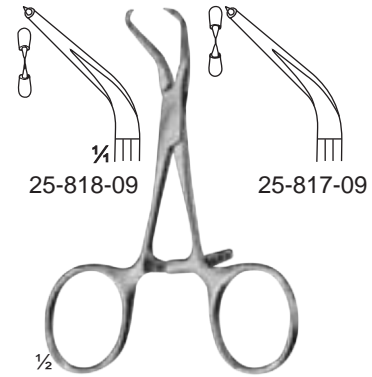

25-817-09 - 25-818-09  
9.5 cm / 3 3/4"



25-819-21  
21 cm / 8 1/4"

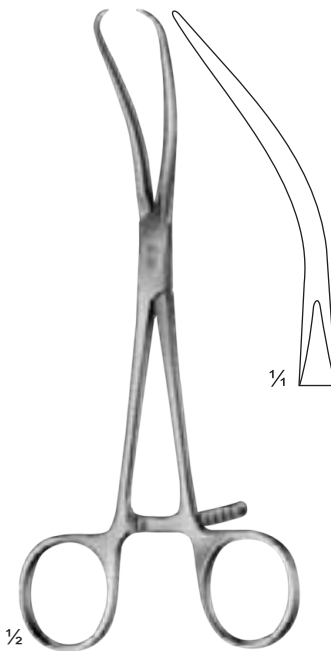

Reill  
25-820-17  
17 cm / 6 3/4"



25-822-20  
20.5 cm / 8"



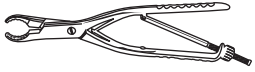

### Bone Holding Forceps, Amputation Retractor

Knochenhalte­zangen, Amputationsschild  
Pinzas para hueso, Retractor para amputación

Daviers porte-os, Retracteur pour amputation  
Tenaglia per ossa, Retrattore per amputazione

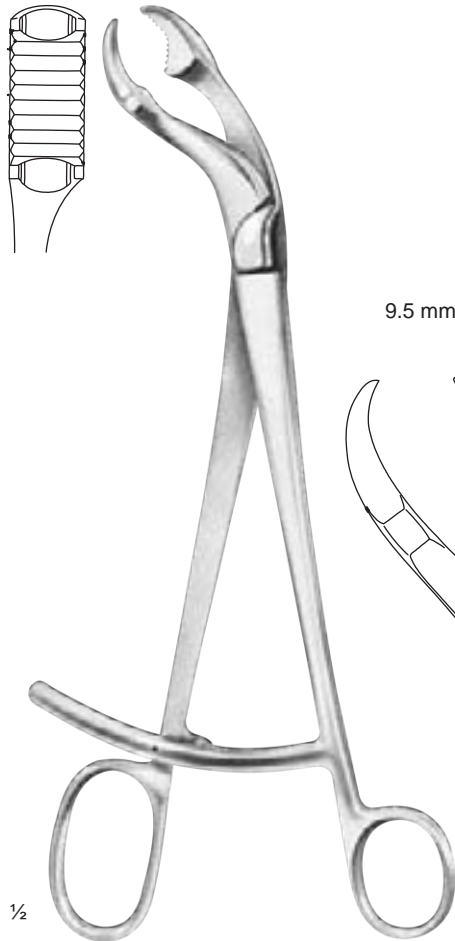
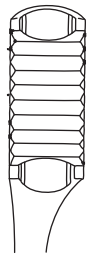

9.5 mm

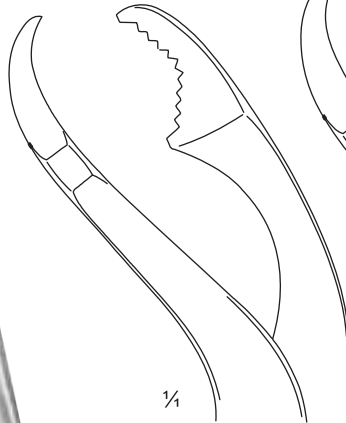

1/4

25-825-01  
25 cm / 10"

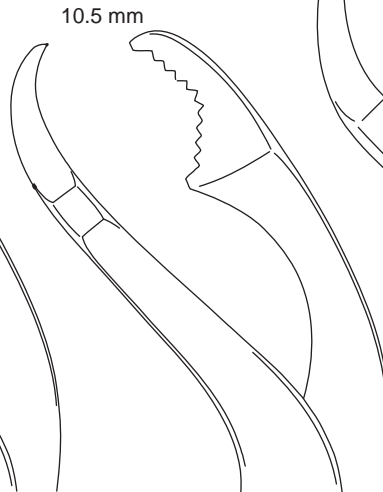

10.5 mm

25-825-02  
26 cm / 10 1/2"

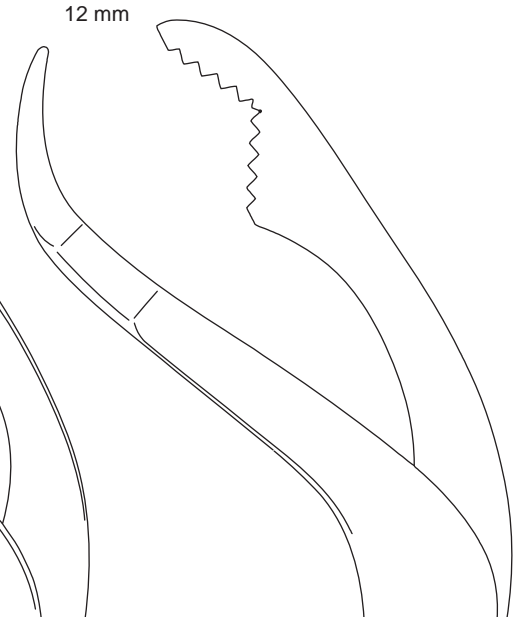

12 mm

25-825-03  
27 cm / 11"

Verburgge  
25-825-01 - 25-825-03

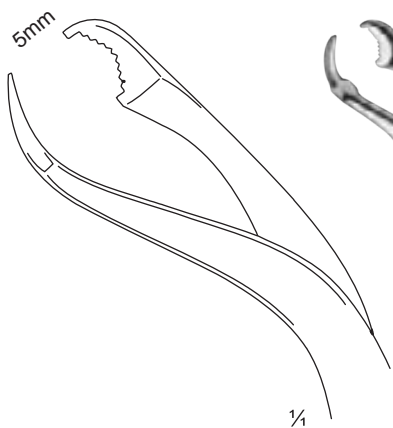

5mm

1/4

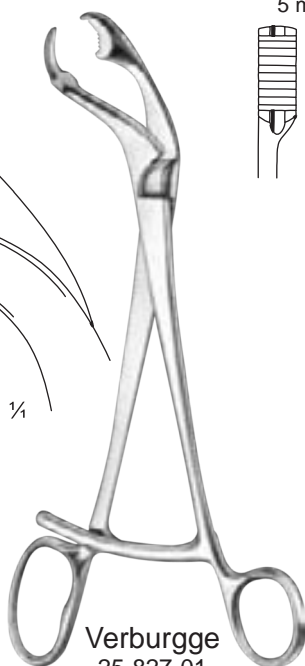

Verburgge  
25-827-01  
17.5 cm / 6 3/4"

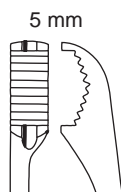

5 mm

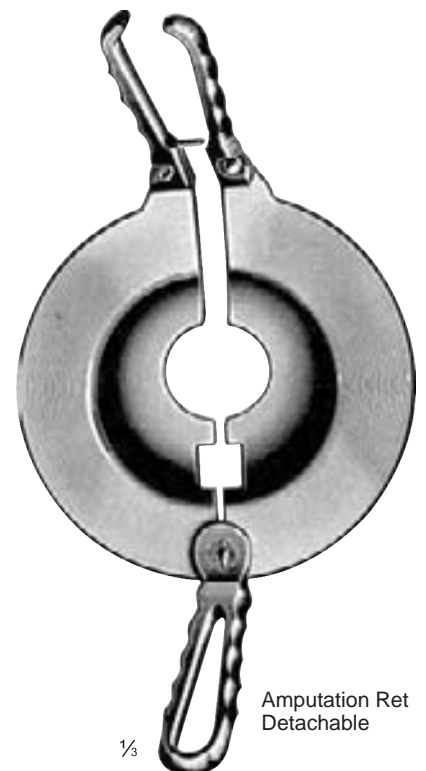

Amputation Ret  
Detachable

1/3

Percy  
25-828-30

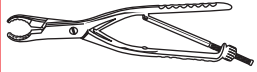

**Bone Rongeurs**

Hohlmeißelzangen  
Pinzas gubias

Pinces-gouges  
Pinze-sgorbie

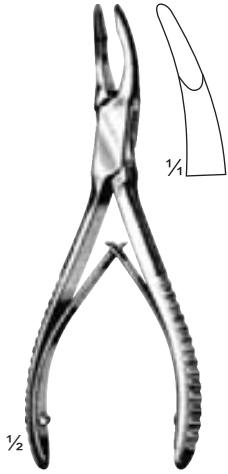

**Mini-Friedman**  
25-831-12  
12 cm / 5"

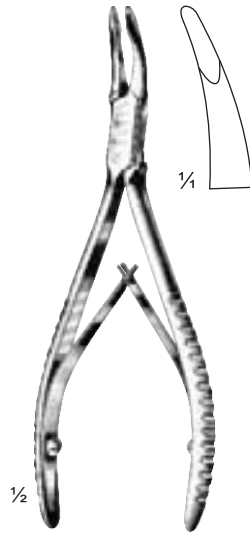

**Friedman**  
25-833-14  
14 cm / 5½"

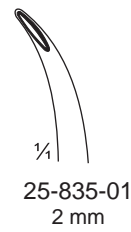

25-835-01  
2 mm

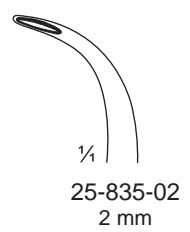

25-835-02  
2 mm

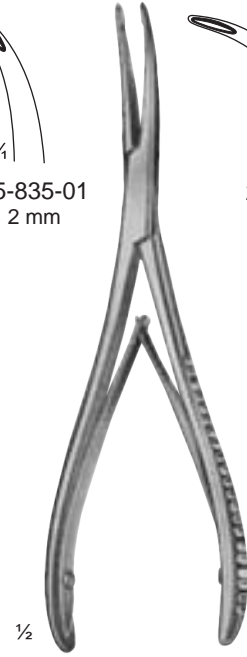

**Stellbrink**  
17 cm / 6¾"

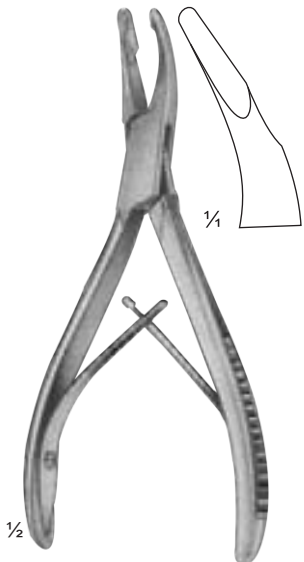

**Universal**  
25-837-13  
13.5 cm / 5¼"

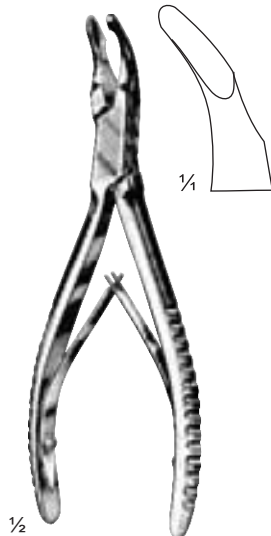

**Cleveland**  
25-839-14  
14 cm / 5½"



**Cleveland**  
25-841-17  
17 cm / 6¾"

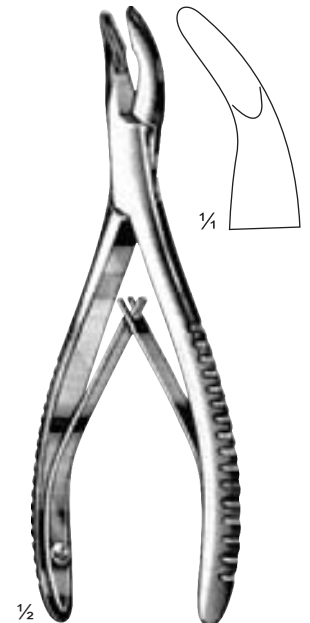

**Mead**  
25-843-16  
16.5 cm / 6½"

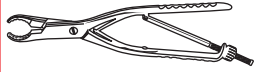

**Bone Rongeurs**

Hohlmeißelzangen  
Pinzas gubias

Pinces-gouges  
Pinze-sgorbie

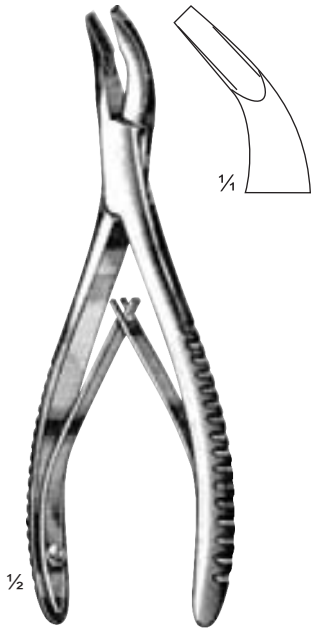

**Mead**  
25-845-16  
16.5 cm / 6½"



**Hartmann**  
25-847-18  
18.5 cm / 7¼"



**Jansen**  
25-850-18 - 25-853-18  
18 cm / 7"

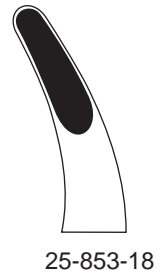
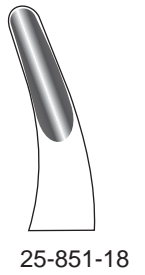

**Lempert**  
25-854-19  
19 cm / 7½"

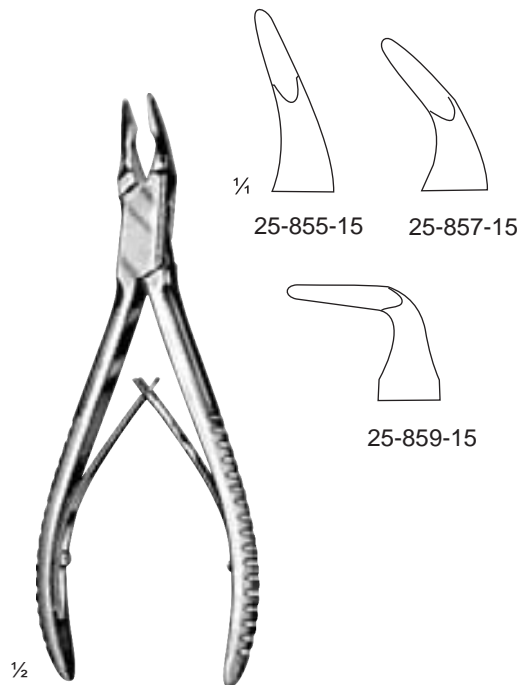

**Blumenthal**  
25-855-15 - 25-859-15  
15.5 cm / 6"



**Luer**  
25-860-17 - 25-861-17  
17 cm / 6¾"

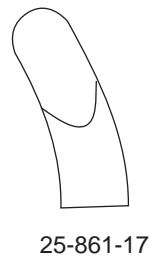
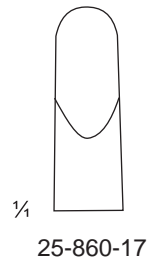



**Bone Rongeurs**

Hohlmeißelzangen  
Pinzas gubias

Pinces-gouges  
Pinze-sgorbie

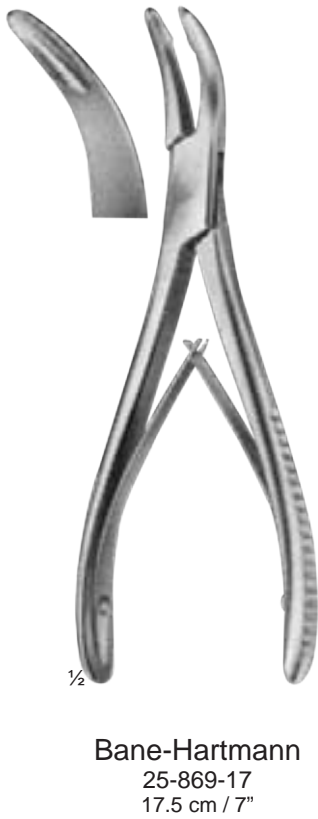
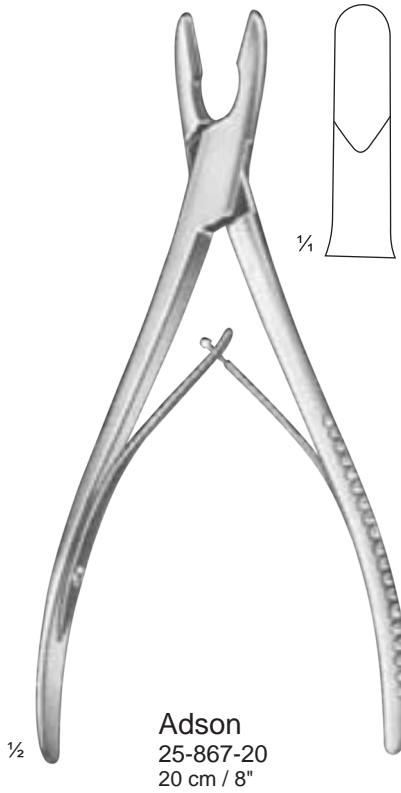

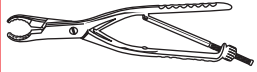

**Bone Rongeurs**

Hohlmeißelzangen  
Pinzas gubias

Pinces-gouges  
Pinze-sgorbie

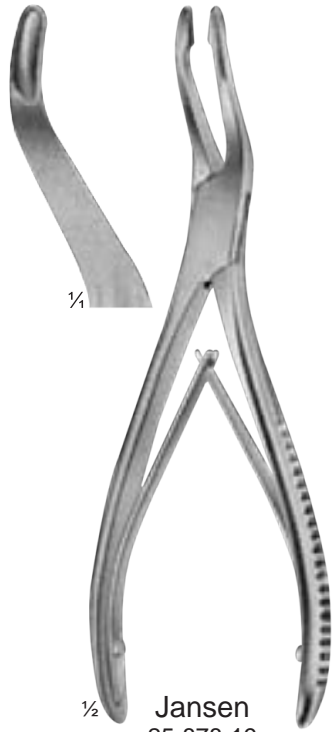

1/2 **Jansen**  
25-878-19  
19 cm / 7 1/2"

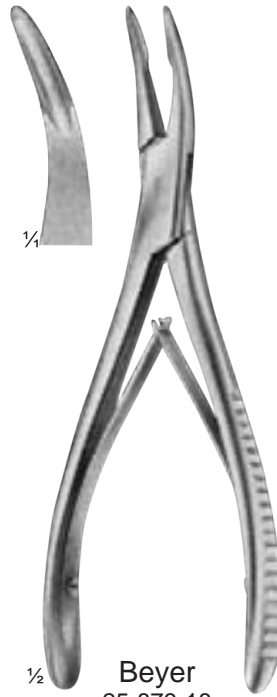

1/2 **Beyer**  
25-879-18  
18 cm / 7"

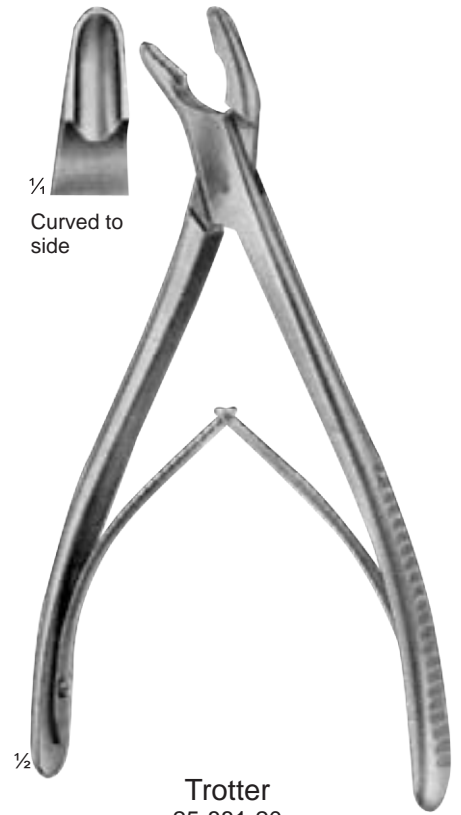

1/2 **Trotter**  
25-881-20  
20.5 cm / 8"



1/2 **Guleke**  
25-882-20  
20.5 cm / 8"

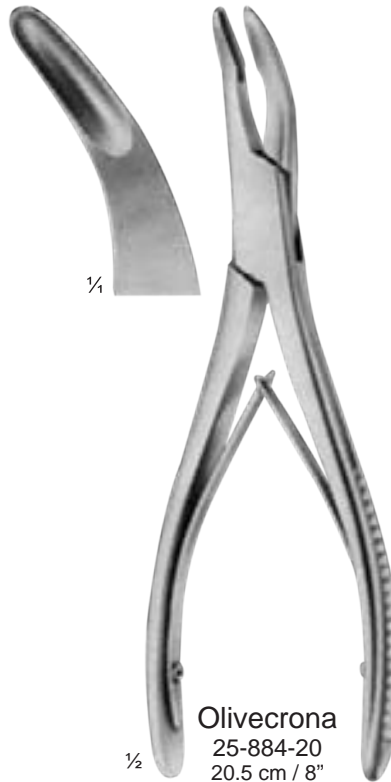

1/2 **Olivecrona**  
25-884-20  
20.5 cm / 8"

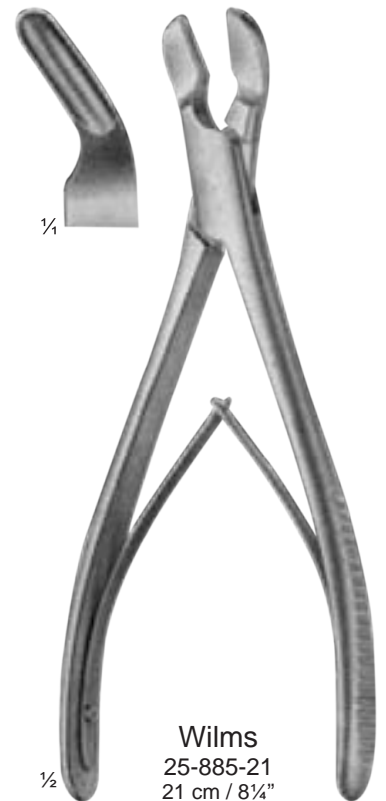

1/2 **Wilms**  
25-885-21  
21 cm / 8 1/4"

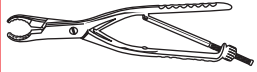

**Bone Rongeurs**

Hohlmeißelzangen  
Pinzas gubias

Pinces-gouges  
Pinze-sgorbie

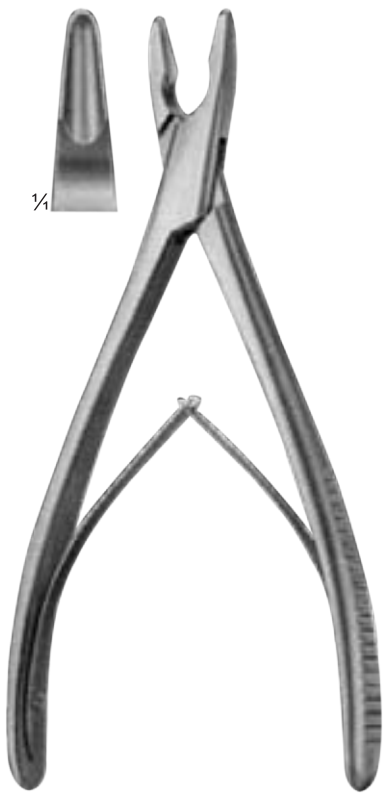

**Pennybacker**  
25-889-20  
20.5 cm / 8"



**Northfield**  
25-890-21  
21 cm / 8 1/4"

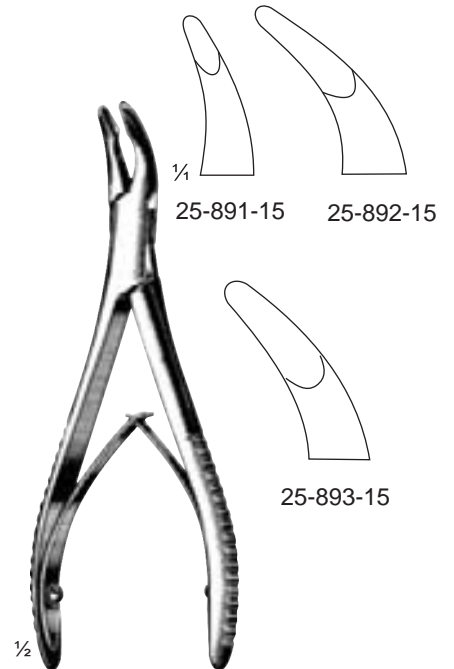

**Luer**  
25-891-15 - 25-893-15  
15 cm / 6"

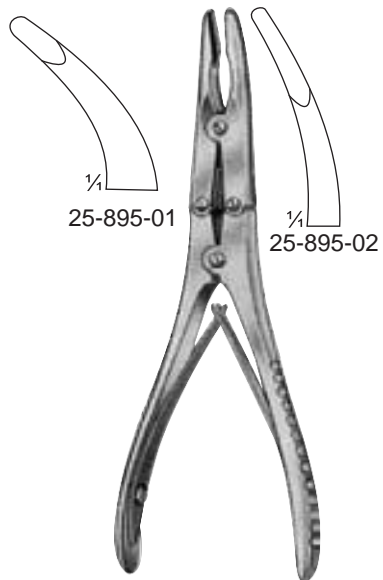

**Kleinert-Kutz**  
15 cm / 6"

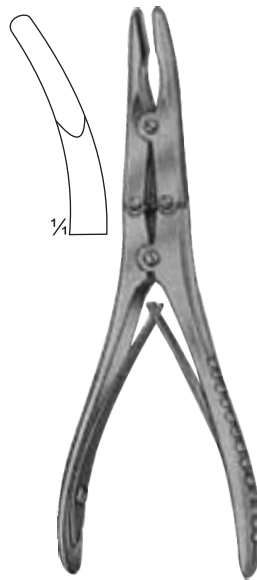

**Ruskin-Mini**  
25-897-15  
15 cm / 6"

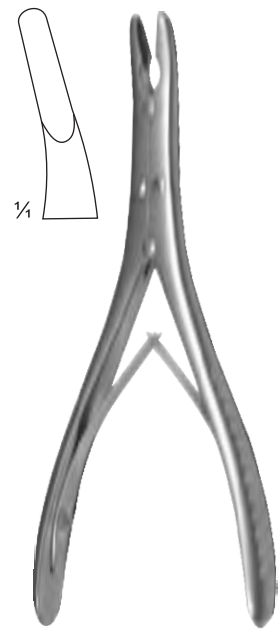

**Jansen Middleton**  
25-899-18  
18 cm / 7"

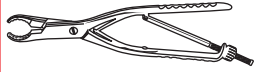

**Bone Rongeurs**

Hohlmeißelzangen  
Pinzas gubias

Pinces-gouges  
Pinze-sgorbie

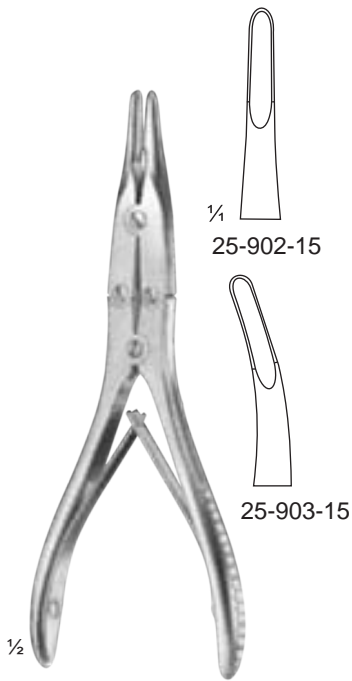

**Bohler**  
25-902-15 - 25-903-15  
15 cm / 6"

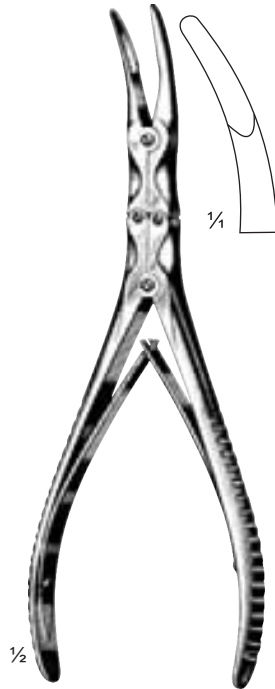

**Beyer**  
25-905-18  
18 cm / 7"

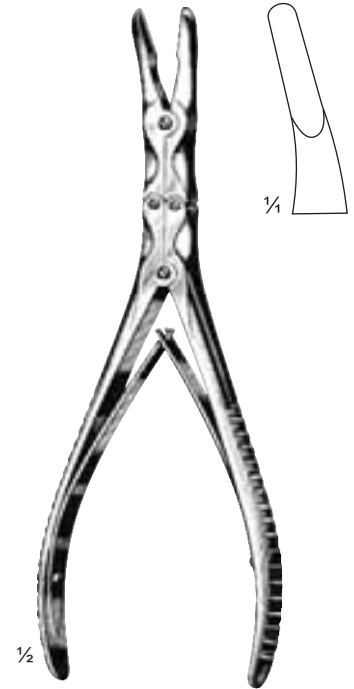

**Zaufal-Jansen**  
25-907-18  
18 cm / 7"

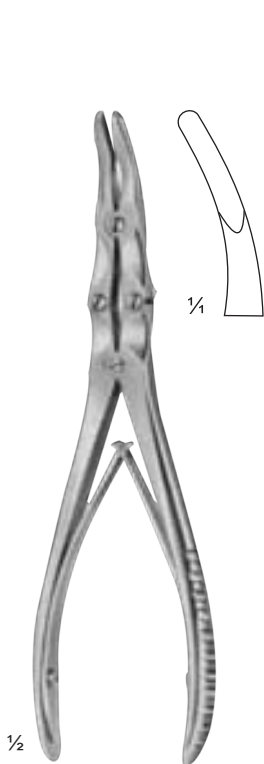

**Mayfield**  
25-909-17  
17 cm / 6 3/4"



**Marquardt**  
25-911-20  
20 cm / 8"

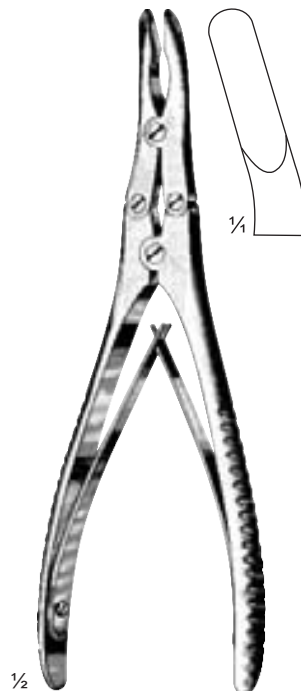

**Ruskin**  
25-913-18  
18 cm / 7"



**Ruskin**  
25-915-23  
23 cm / 9"

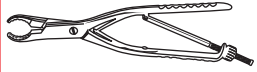

**Bone Rongeurs**

Hohlmeißelzangen  
Pinzas gubias

Pinces-gouges  
Pinze-sgorbie

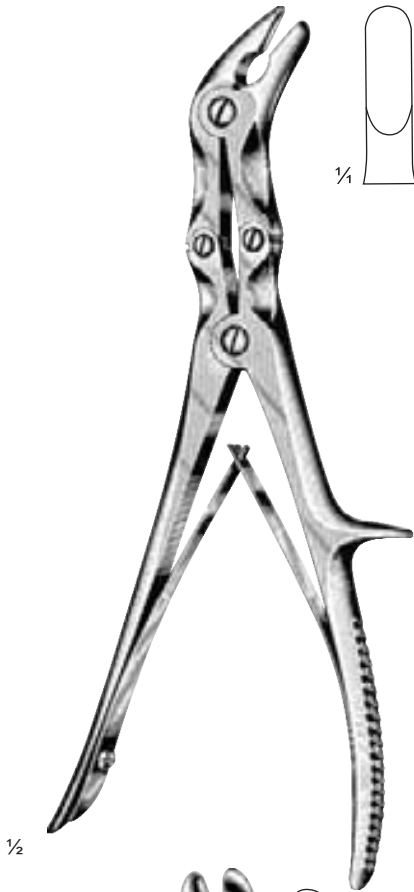

**Stille**  
25-917-23  
23 cm / 9"

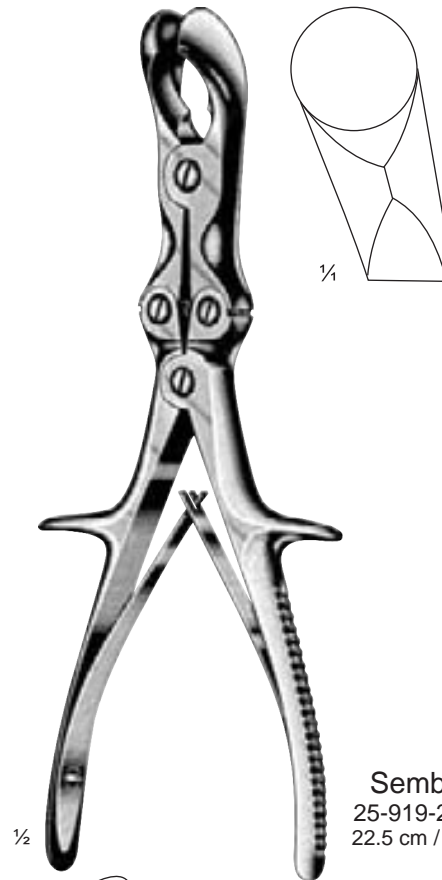

**Semb**  
25-919-22  
22.5 cm / 9"



**Stille-Ruskin**  
25-921-23  
23 cm / 9"

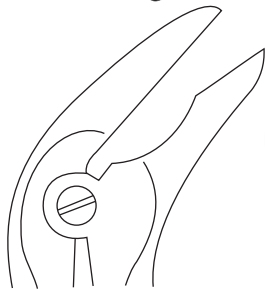

**Echlin**  
25-923-02 - 25-923-04  
23 cm / 9"

1/4  
25-923-02

1/4  
25-923-03

1/4  
25-923-04



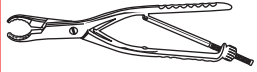

**Bone Rongeurs**

Hohlmeißelzangen  
Pinzas gubias

Pinces-gouges  
Pinze-sgorbie



**Frykholm**  
25-925-24  
24 cm / 9½"



**Leksell-Stille**  
25-927-24 - 25-929-24  
24 cm / 9½"

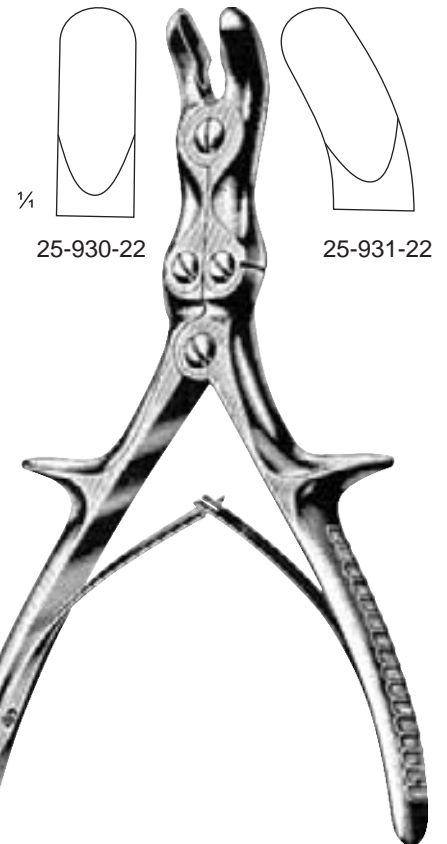

**Stille-Luer**  
25-930-22 - 25-931-22  
22 cm / 8¾"

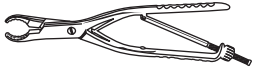

**Bone Rongeurs**

Hohlmeißelzangen  
Pinzas gubias

Pinces-gouges  
Pinze-sgorbie

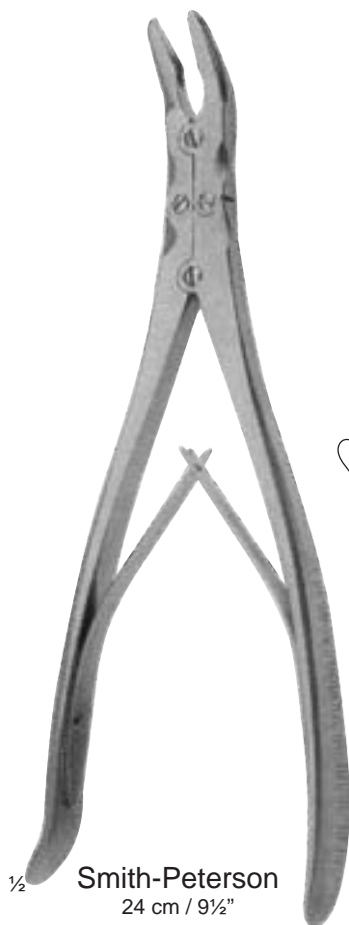

$\frac{1}{2}$  Smith-Peterson  
24 cm / 9½"



$\frac{1}{4}$   
3 mm  
25-933-03



$\frac{1}{4}$   
4 mm  
25-933-04



$\frac{1}{4}$   
5 mm  
25-933-05



$\frac{1}{4}$   
3 mm  
25-935-03



$\frac{1}{4}$   
4 mm  
25-935-04



$\frac{1}{4}$   
5 mm  
25-935-05



$\frac{1}{2}$  Ruskin  
25-936-23  
23 cm / 9"

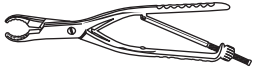

**Bone Rongeurs**

Hohlmeißelzangen  
Pinzas gubias

Pinces-gouges  
Pinze-sgorbie

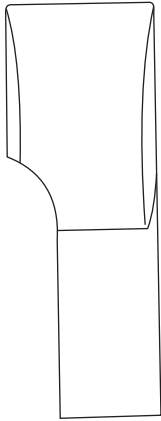

25-938-31

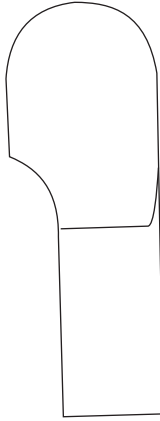

25-940-31

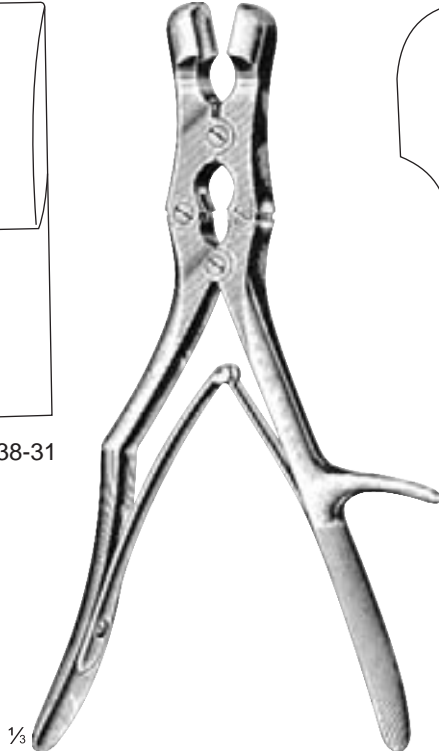

1/3

**Sauerbruch**  
25-938-31 - 25-940-31  
31 cm / 12 1/4"



25-942-23 = 23 cm / 9"  
25-942-27 = 27 cm / 10 1/2"



25-943-23 = 23 cm / 9"  
25-943-27 = 27 cm / 10 1/2"

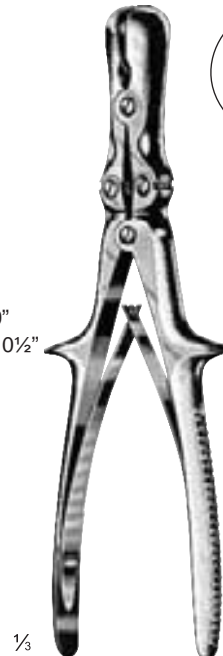

1/3

**Stille-Luer**  
25-942-23 - 25-943-27



**Bone Cutting Forceps**

Knochensplitterzangen  
Pinzas cortantes para hueso

Pincas coupantes à os  
Cesoie per ossa



**Paton**  
25-946-14  
14 cm / 5½"

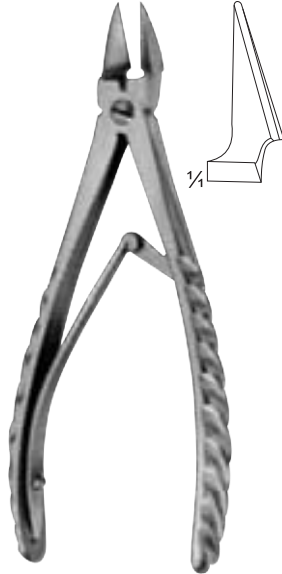

**Stamm**  
25-948-15  
15 cm / 6"

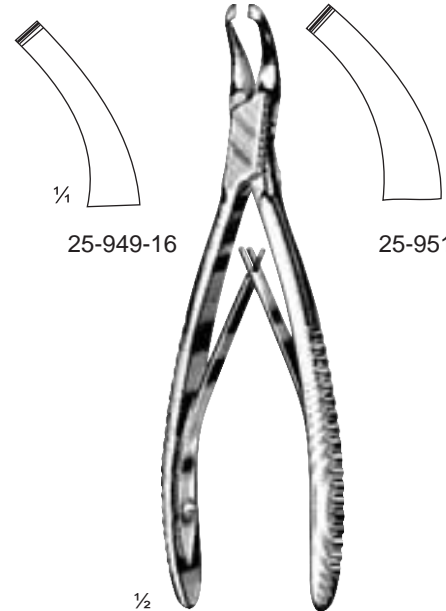

**Cleveland-Gardner**  
25-949-16 - 25-951-16  
16 cm / 6¼"

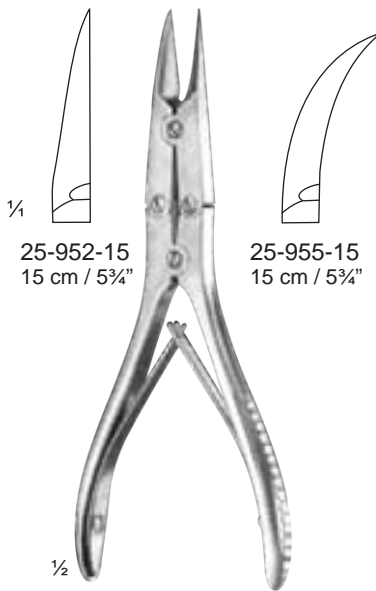

25-952-15  
15 cm / 5¾"

25-955-15  
15 cm / 5¾"

25-952-15 - 25-955-15  
15 cm / 5¾"

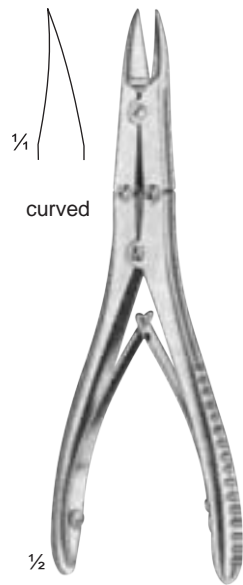

1/4  
curved

**Walton-Liston**  
25-958-15  
15 cm / 5¾"

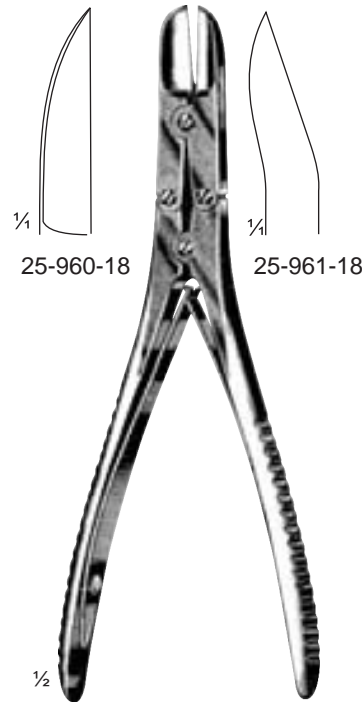

25-960-18

25-961-18

**Ruskin-Liston**  
25-960-18 - 25-961-18  
18.5 cm / 7¼"



**Mc Indoe**  
25-962-17  
17.5 cm / 7"



**Bone Cutting Forceps**

Knochensplitterzangen  
Pinzas cortantes para hueso

Pinces coupantes à os  
Cesoie per ossa

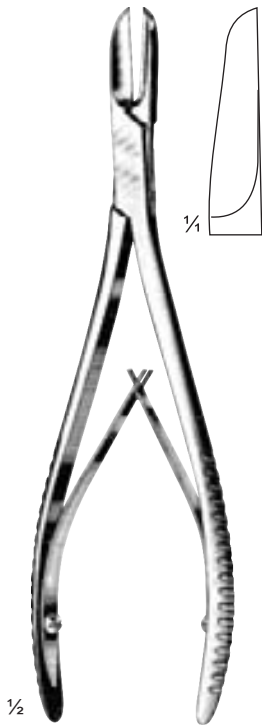

**Cottle Kazanjan**  
25-964-19  
19 cm / 7½"

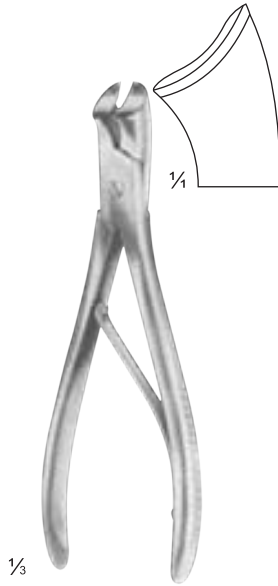

**Markwalder**  
25-966-20  
20 cm / 8"

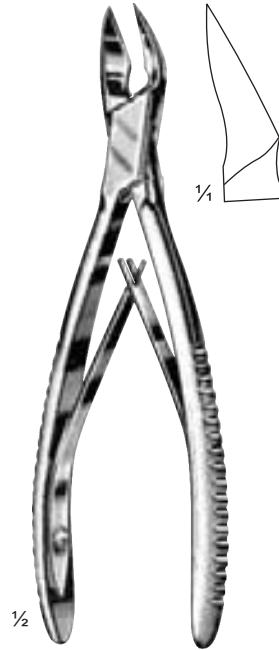

**Cleveland**  
25-969-17  
17 cm / 6¾"

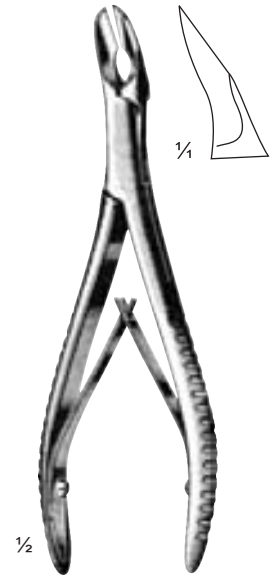

**Cleveland**  
25-971-15  
15 cm / 6"



25-974-14  
14 cm / 5½"



25-974-17  
17 cm / 6¾"

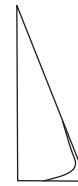

25-975-14  
14 cm / 5½"



25-975-17  
17 cm / 6¾"

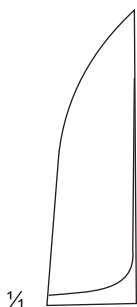

25-974-19  
19 cm / 7½"



25-974-22  
22 cm / 8¾"



**Liston**  
25-974-14 - 25-975-22

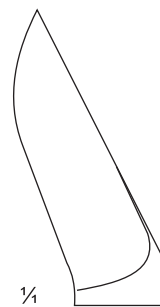

25-975-19  
19 cm / 7½"

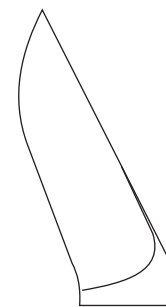

25-975-22  
22 cm / 8¾"



**Bone Cutting Forceps**

Knochensplitterzangen  
Pinzas cortantes para hueso

Pinces coupantes à os  
Cesoie per ossa

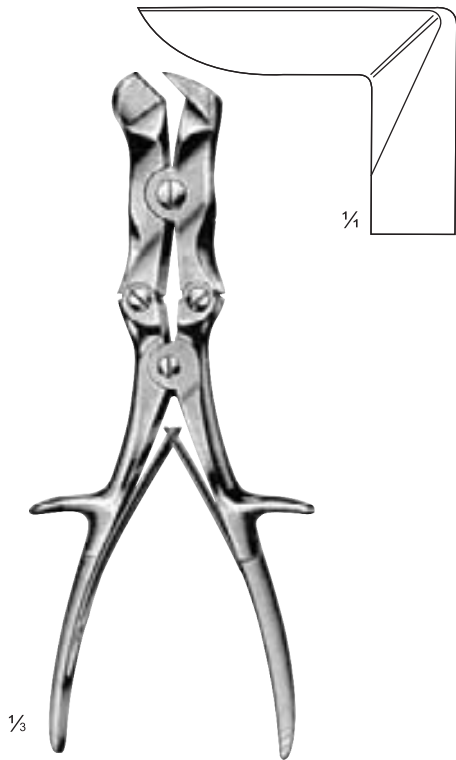

**Stille-Liston**  
25-976-27  
27 cm / 10½"

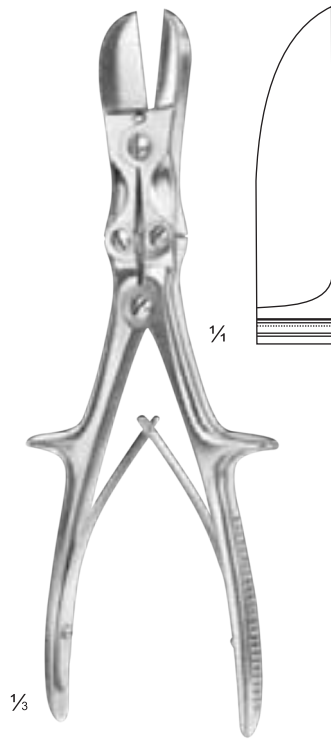

**Stille-Liston**  
25-978-27  
27 cm / 10½"

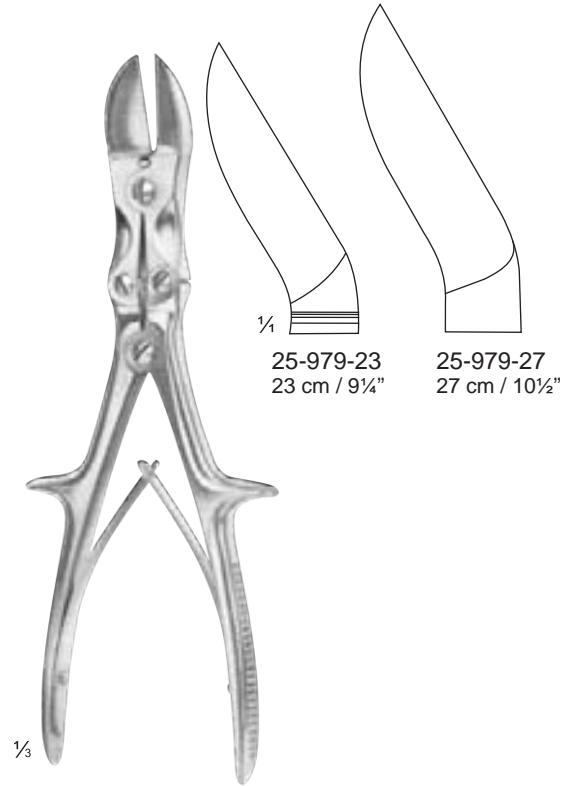

**Stille-Liston**  
25-979-23 - 25-979-27

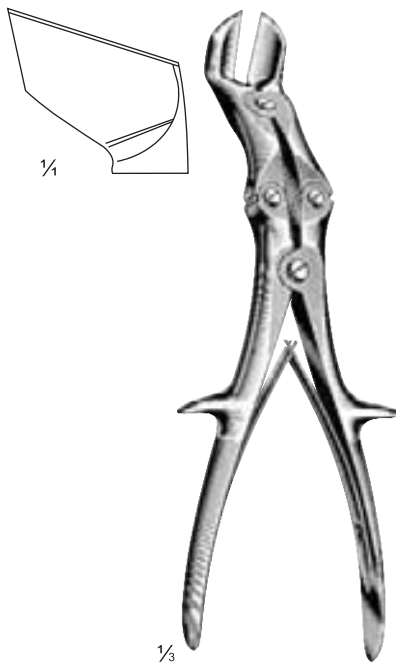

**Liston-Key (Tuder-Edwards)**  
25-981-27  
27 cm / 10½"

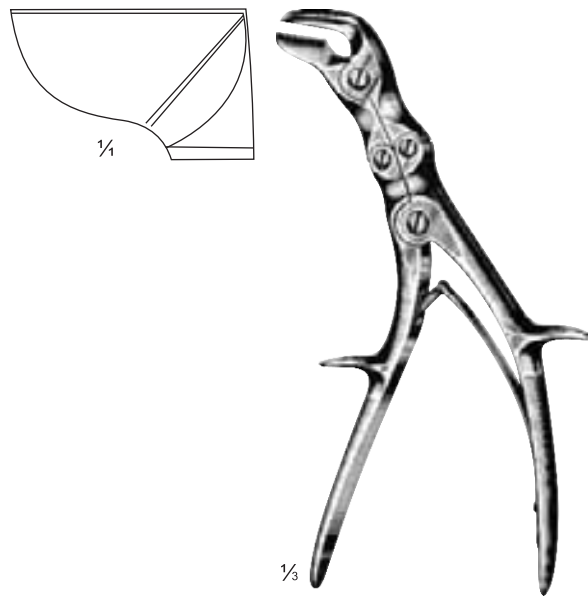

**Semb**  
25-983-24  
24 cm / 9½"



**Lead Hands, Tourniquet, Finger Nail Drill**

Bleihände, Kompressorium, Fingernagelbohrer  
 Manoplas de plomo, Compresor, Perforador para uñas

Manches en plomb, Compresseur, Perforateur à ongles  
 Mani di piombo, compressorio, Perforatore per unghie

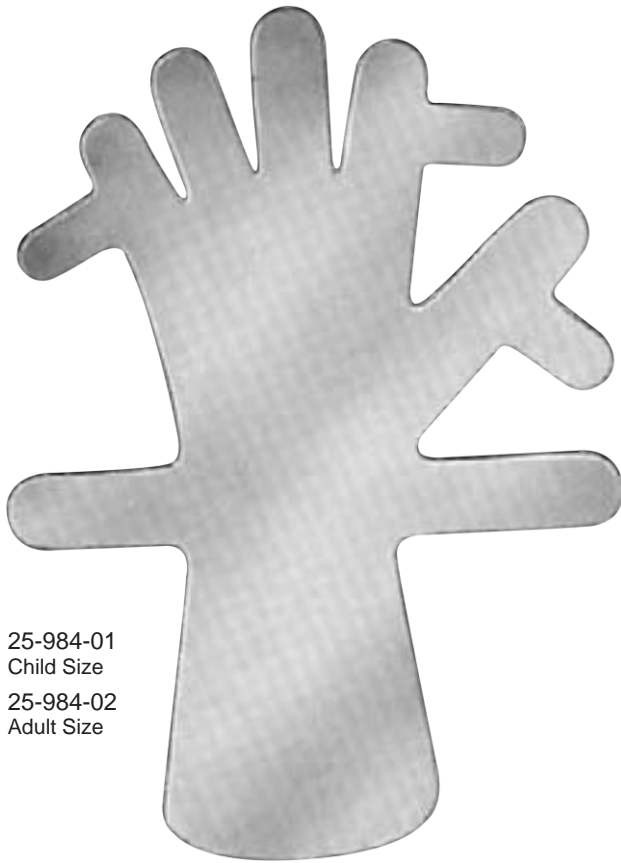

25-984-01  
 Child Size  
 25-984-02  
 Adult Size

Lead hand



Feldheim  
 25-986-10  
 10 cm / 4"



1/2  
 Ideal  
 25-987-10



25-988-01



25-988-02



25-988-03

25-988-00 = Set

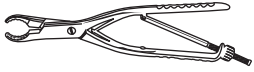

### Finger Ring Saws, Nail Extracting Forceps

Fingerringssägen, Nagelextraktionszangen  
Sierras para abrir anillos, Pinzas para arrancar uñas

Scies pour couper les bagues, Pinces pour extraire les ongles  
Seghe per anelli, Pinze per la lacerazione delle unghie



25-991-01  
Spare blade only

1/2

Walton  
25-990-16  
16 cm / 6 1/4"



25-994-01  
Spare blade only

1/2

25-993-17  
17 cm / 6 3/4"

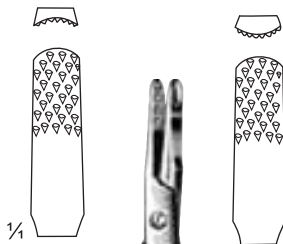

1/4

1/2

Radolf  
25-996-13  
13.5 cm / 5 1/4"

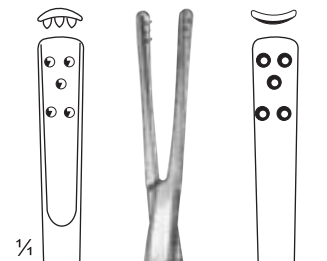

1/4

1/2

Penner  
25-998-15  
15.5 cm / 6"