

Falcon[®]

Surgical
Instruments



33

GYNECOLOGY

GYNÄKOLOGIE
GINECOLOGÍA
GYNÉCOLOGIE
GINECOLOGIA





Vaginal Specula

Vaginālspekula
Espéculos vaginales

Spéculums vaginaux
Specoli vaginali



Fergusson

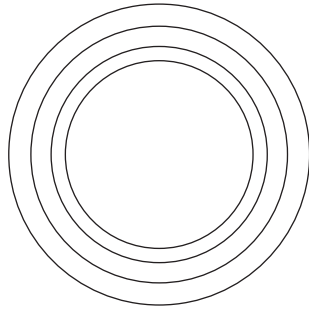

Fig.	mm ø	
1	25	33-002-01
2	30	33-002-02
3	35	33-002-03
4	40	33-002-04

Metal Specula, tubular shape



for children

Collin
33-004-01
55 x 10 mm



Cusco virgin
33-006-01
75 x 18 mm



Cusco
33-008-01 = 75 x 32 mm
33-008-02 = 85 x 35 mm
33-008-03 = 100 x 35 mm



Vaginal Specula

Vaginalspekula
Espéculos vaginales

Spéculums vaginaux
Specoli vaginali



Cusco

33-016-01 = 75 x 32 mm
33-016-02 = 85 x 35 mm
33-016-03 = 100 x 37 mm



Cusco

33-018-01 = 80 x 22 mm
33-018-02 = 100 x 25 mm
33-018-03 = 105 x 27 mm
Swiss pattern



Collin

33-020-01 = 85 x 30 mm
33-020-02 = 100 x 35 mm
33-020-03 = 110 x 40 mm



Collin

33-022-01
65 x 20 mm



Trelat

33-024-01 = 85 x 33 mm
33-024-02 = 95 x 35 mm
33-024-03 = 115 x 43 mm

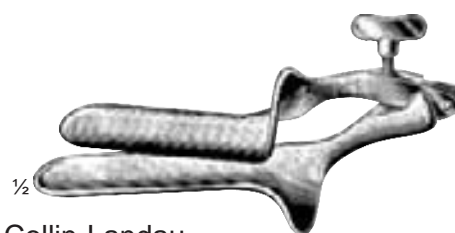

Collin-Landau

33-026-00
100 x 35 mm



Vaginal Specula

Vaginalspekula
Espéculos vaginales

Spéculums vaginaux
Specoli vaginali

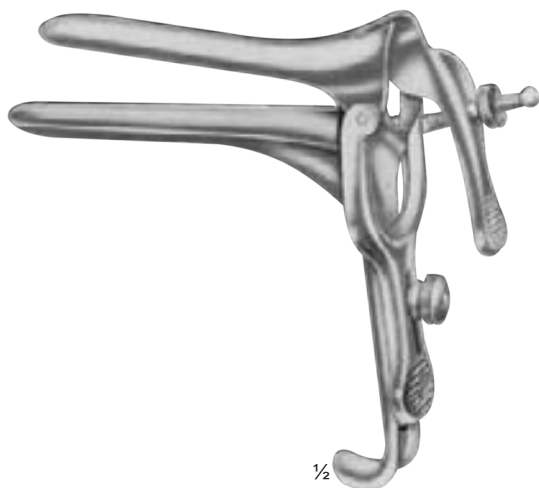

½

Pederson

33-030-01 = 75 x 13 mm
33-030-02 = 100 x 22 mm
33-030-03 = 120 x 25 mm



½

Grave

33-032-01 = 75 x 20 mm
33-032-02 = 95 x 35 mm
33-032-03 = 115 x 35 mm



½

Semm

33-034-01 = 100 x 17/20 mm
33-034-02 = 100 x 25/30 mm



½

Seyffert

33-036-01 = 100 x 17 mm
33-036-02 = 110 x 33 mm



½

Seyffert

33-038-02 = 110 x 33 mm

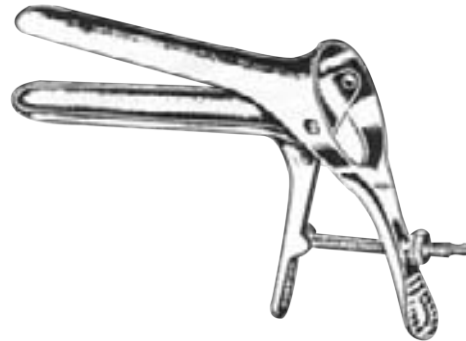
**Vaginal Specula, Vaginal Retractors**Vaginalspekula, Scheidenhalter
Espéculos vaginales, Valvas vaginalesSpéculums vaginaux, Valves vaginales
Specoli vaginali, Valve vaginali**Cusco-British Patt**33-043-01 = 65 x 15 mm Virgin
33-043-02 = 80 x 25 mm Small
33-043-03 = 90 x 30 mm Medium
33-043-04 = 95 x 35 mm Large
33-043-05 = 115 x 30 mm MXL**Winterton**33-045-09
115 x 25 mm**Liverpool Hosp Patt**

33-047-27 = 100 x 16 mm = 100 x 22 mm

**St. George Hosp Patt**33-050-01 = 95 x 25 mm = 115 x 30 mm
33-050-02 = 100 x 28 mm = 120 x 30 mm



Vaginal Specula, Vaginal Retractors

Vaginalspekula, Scheidenhalter
Especulos vaginales, Valvas vaginales

Spéculums vaginaux, Valves vaginales
Specoli vaginali, Valve vaginali

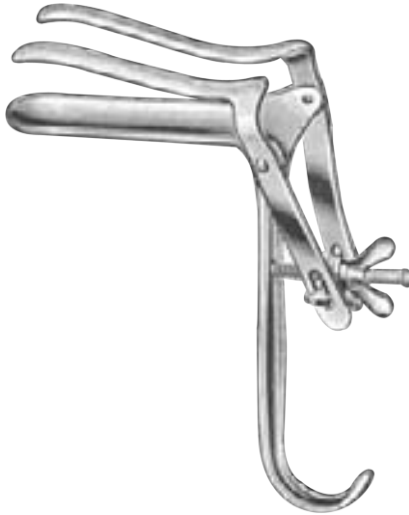

Nott

33-055-01 = 90 x 30 mm
33-055-02 = 110 x 30 mm



Breisky

33-056-01 70 x 22 mm/76 x 25 mm
33-056-02 76 x 25 mm/82 x 30 mm
33-056-03 82 x 30 mm/ 95 x 38 mm



1/2

Jackson

33-058-01 = 75 x 35 mm
33-058-02 = 90 x 35 mm
33-058-03 = 100 x 35 mm
33-060-01 = 75 x 40 mm
33-060-02 = 90 x 40 mm
33-060-03 = 100 x 40 mm



1/2

Sims

33-062-01 = 65x25 mm
= 70x30 mm
33-062-02 = 70x30 mm
= 70x35 mm
33-062-03 = 85x35 mm
= 90x40 mm



1/2

Guttmann

33-064-01
90 x 35 mm

Vaginal Specula, Vaginal Retractors

Vaginalspekula, Scheidenhalter
 Espéculos vaginales, Valvas vaginales

Spéculums vaginaux, Valves vaginales
 Specoli vaginali, Valve vaginali

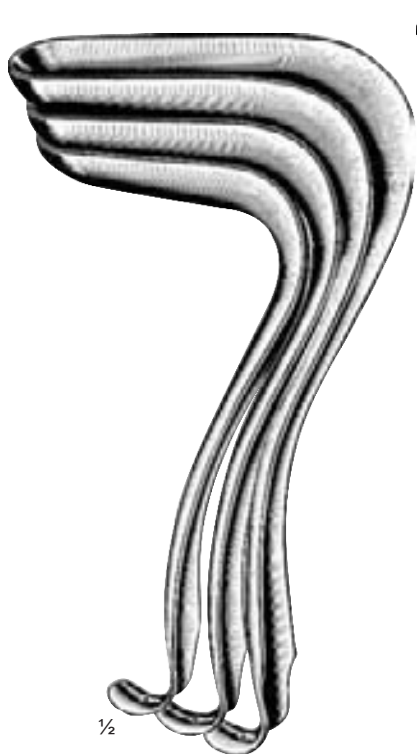

1/2

**Kirsteller
 Specula**

- Fig.1 33-070-01 = 70 x 27 mm
- Fig.2 33-070-02 = 80 x 30 mm
- Fig.3 33-070-03 = 90 x 36 mm



1/2

**Kristeller
 Retractors**

- Fig.1 33-073-01 = 75 x 23 mm
- Fig.2 33-073-02 = 85 x 26 mm
- Fig.3 33-073-03 = 100 x 32 mm



1/2

Kristeller

- Set of 1 Speculum and 1 Retractor each
- Fig. 1 33-075-01
- Fig. 2 33-075-02
- Fig. 3 33-075-03

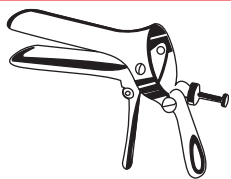

Vaginal Specula, Vaginal Retractors

Vaginalspekula, Scheidenhalter
 Espéculos vaginales, Valvas vaginales

Spéculums vaginaux, Valves vaginales
 Specoli vaginali, Valve vaginali

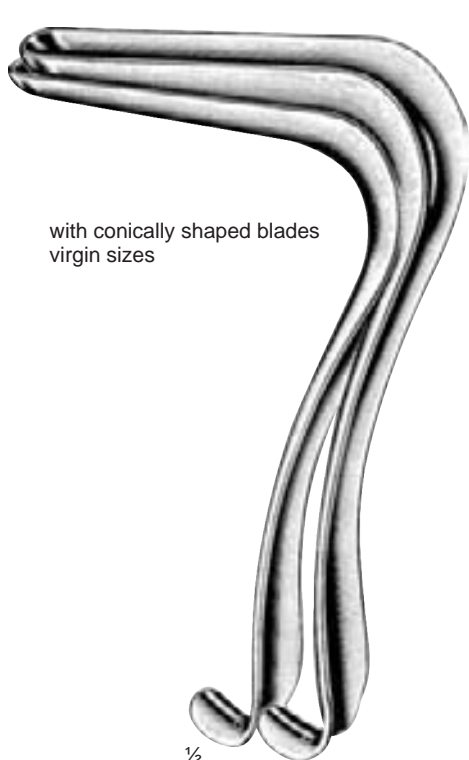

with conically shaped blades
 virgin sizes

1/2

**Kirsteller
 Specula**

33-078-01 = 105 x 18 mm
 33-078-02 = 105 x 21 mm



1/2

**Kirsteller
 Retractors**

33-081-01 = 110 x 14 mm
 33-081-02 = 110 x 17 mm



1/2

Kirsteller

set of 1 Speculum and
 1 Retractor each
 33-083-01
 33-083-02

Vaginal Specula, Vaginal Retractors

Vaginalspekula, Scheidenhalter
Especulos vaginales, Valvas vaginales

Spéculums vaginaux, Valves vaginales
Specoli vaginali, Valve vaginali

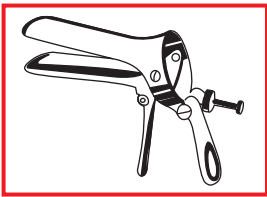

1/2

Kristeller Specula

- Fig.1 33-086-01 = 105 x 26 mm
- Fig.2 33-086-02 = 105 x 28 mm
- Fig.3 33-086-03 = 105 x 33 mm



Specula flat hollow

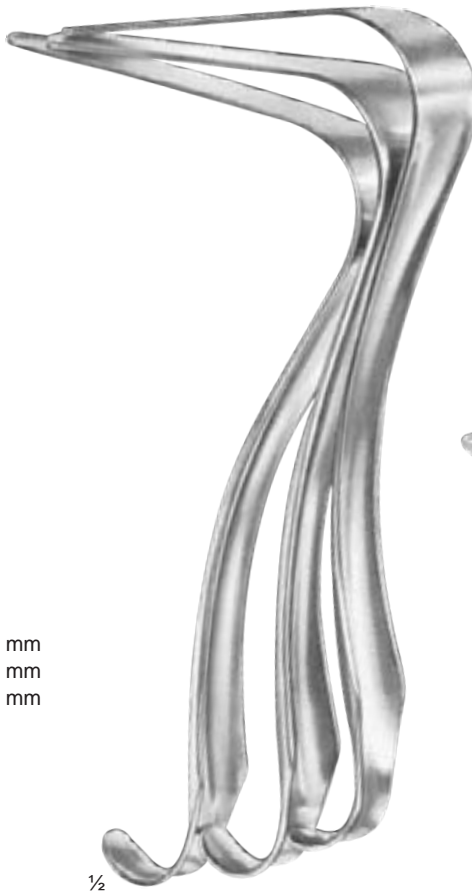

1/2

Kristeller Retractors

- Fig.1 33-089-01 = 115 x 22 mm
- Fig.2 33-089-02 = 115 x 24 mm
- Fig.3 33-089-03 = 115 x 29 mm



1/2

Kristeller

Set of 1 Speculum and
1 Retractor each

- Fig.1 33-091-01
- Fig.2 33-091-02
- Fig.3 33-091-03



Vaginal Specula, Vaginal Retractors

Vaginalspekula, Scheidenhalter
Especulos vaginales, Valvas vaginales

Spéculums vaginaux, Valves vaginales
Specoli vaginali, Valve vaginali

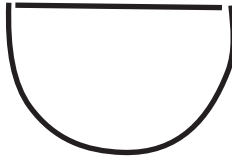
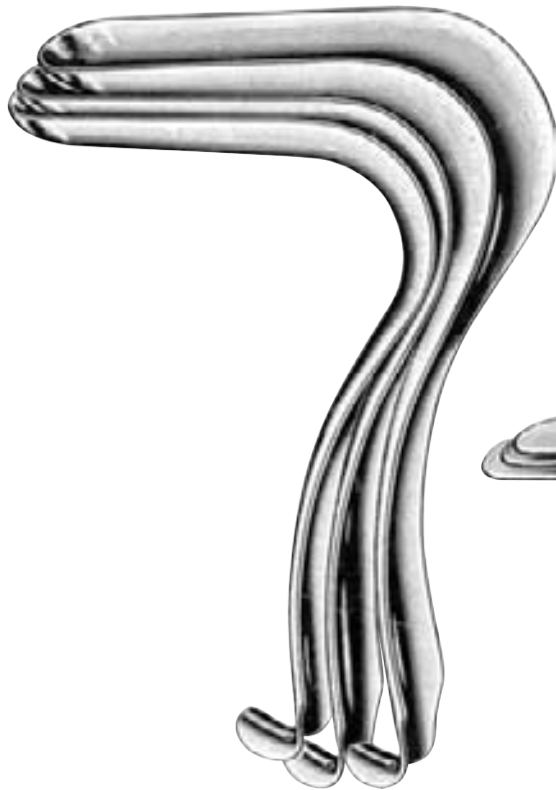

Specula deep hollow



**Kirsteller
Specula**

- 33-094-01 = 110 x 27 mm
- 33-094-02 = 110 x 30 mm
- 33-094-03 = 110 x 36 mm

**Kirsteller
Retractors**

- 33-097-01 = 115 x 23 mm
- 33-097-02 = 115 x 26 mm
- 33-097-03 = 115 x 32 mm



Kirsteller

- Set of 1 Speculum and 1 Retractor each
- 33-099-01
- 33-099-02
- 33-099-03

Vaginal Specula, Vaginal Retractors

Vaginalspekula, Scheidenhalter
 Espéculos vaginales, Valvas vaginales

Spéculums vaginaux, Valves vaginales
 Specoli vaginali, Valve vaginali

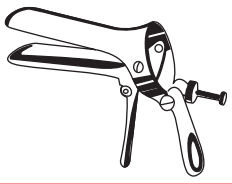

56 x 13 mm

½

Braun
 33-102-01
 18 cm / 7"



60 x 10 mm

½

Braun
 33-105-01
 18 cm / 7"

½

33-108-03
 140 x 30 mm

½

33-111-03
 135 x 36 mm

½

33-113-03

Set of 1 Speculum
 and 1 Retractor

Vaginal Specula, Vaginal Retractors

Vaginalspekula, Scheidenhalter
Espéculos vaginales, Valvas vaginales

Spéculums vaginaux, Valves vaginales
Specoli vaginali, Valve vaginali



Kallmorgen
Vaginal Specula
33-118-01 = 70 x 40 mm
33-118-02 = 90 x 40 mm

Kallmorgen
Vaginal Retractors
33-119-01 = 70 x 33 mm
33-119-02 = 90 x 33 mm

Set
33-121-01
33-121-02

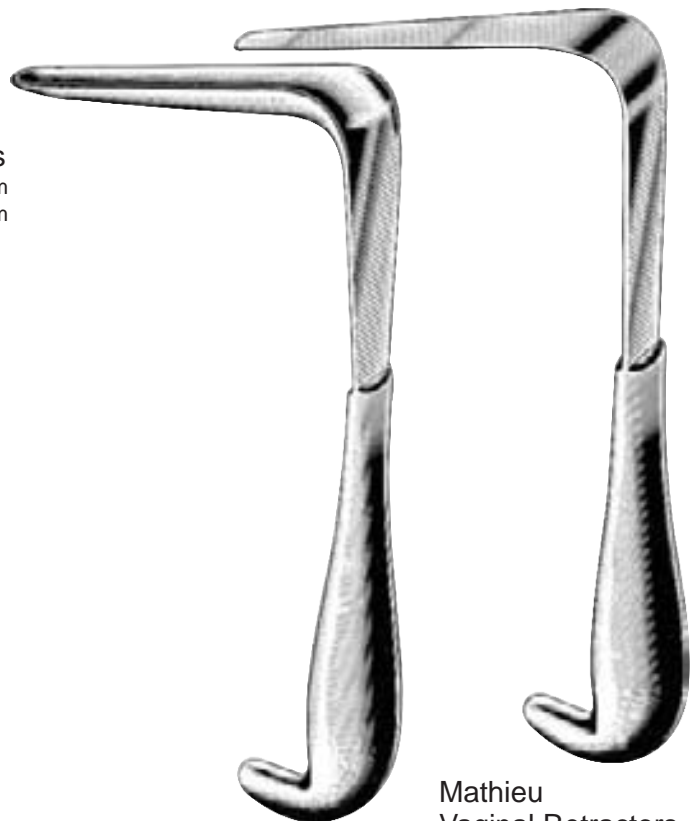

Mathieu
Vaginal Specula
33-124-01 = 95 x 16 mm
= 95 x 26 mm
33-124-02 = 95 x 16 mm
= 95 x 30 mm

Mathieu
Vaginal Retractors
33-125-01 = 100 x 11 mm
= 100 x 20 mm
33-128-02 = 100 x 14 mm
= 100 x 26 mm

Set
33-127-01
33-127-02



Vaginal Specula

Vaginālspekula
Espéculos vaginales

Spéculums vaginaux
Specoli vaginali

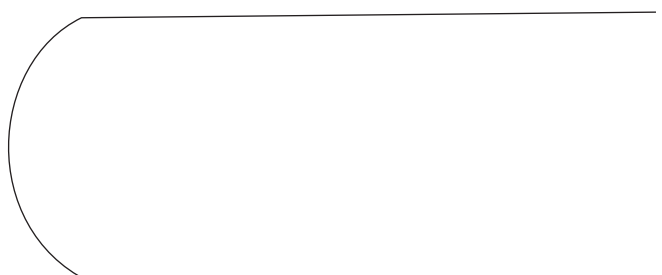
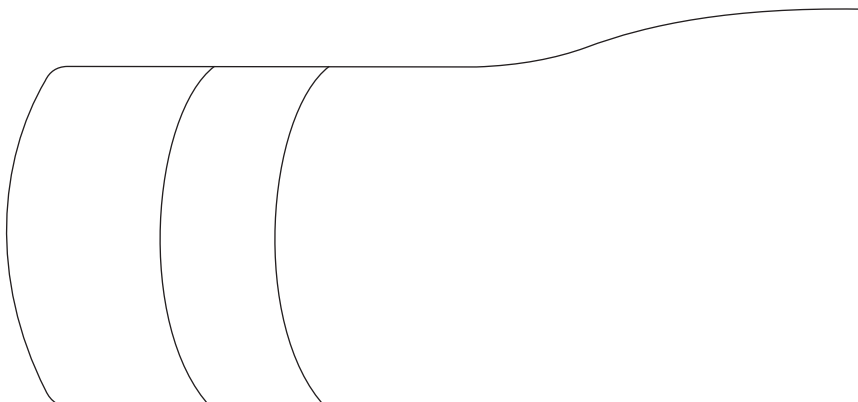

¼

¼



½

Fig.	a mm	b mm	Slightly-concave
1	55	35	33-133-01
2	85	35	33-133-02
3	115	35	33-133-03
1	55	45	33-134-01
2	85	45	33-134-02
3	115	45	33-134-03
4	160	45	33-134-04
1	55	60	33-135-01
2	85	60	33-135-02
3	115	60	33-135-03
4	160	60	33-135-04

½

Doyen
33-133-01 - 33-135-04

Fig.	a mm	b mm
33-138-01 = 1	75	45
33-138-02 = 2	90	45
33-138-03 = 3	110	45

Doyen
33-138-01 - 33-138-03

Vaginal Specula

Vaginālspekula
Espéculos vaginales

Spéculums vaginaux
Specoli vaginali

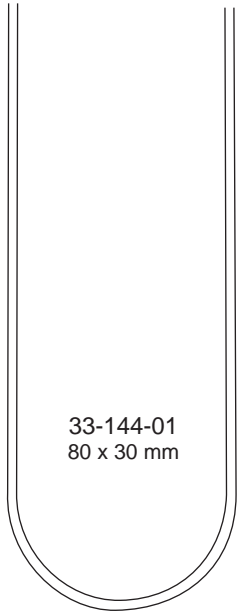

33-144-01
80 x 30 mm

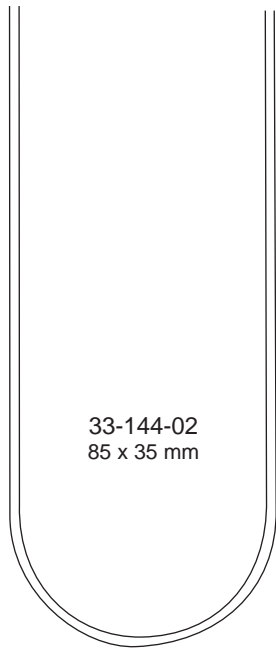

33-144-02
85 x 35 mm

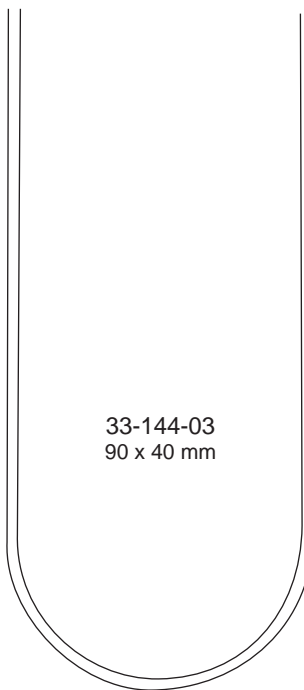

33-144-03
90 x 40 mm



½

33-144-01 - 33-144-03



33-144-04
55 x 40/60 mm

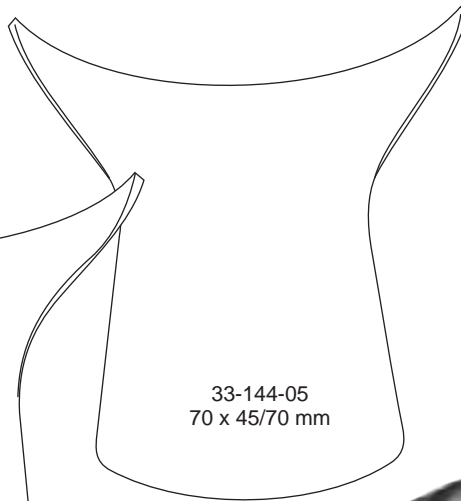

33-144-05
70 x 45/70 mm

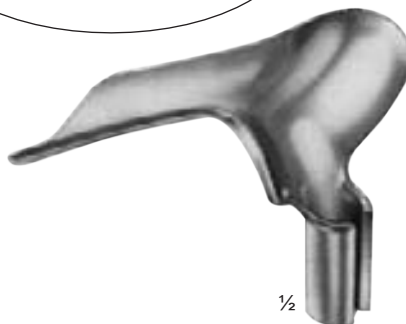

½

33-144-04 - 33-144-05



33-144-10
Weight, light, 400 grs.
33-144-12
Weight, heavy, 800 grs.

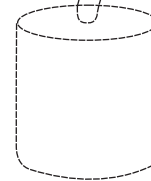

Scherbak
33-144-00



½

33-144-10 - 33-144-12

Vaginal Specula

Vaginalspekula
Espéculos vaginales

Spéculums vaginaux
Specoli vaginali



80 x 38 mm

½

Auvard
33-148-00
complete, with removable weight



Auvard
with fixed weight
23 cm / 9"
45 x 90 mm = 33-150-01
50 x 90 mm = 33-150-02



85 x 36mm

½

Samuel
33-152-00



Auvard
23 cm / 9"
a b
33-154-01 = 80 x 38 mm
33-154-02 = 102 x 45 mm



Vaginal Specula, Vaginal Retractors

Vaginalspekula, Scheidenhalter
Especulos vaginales, Valvas vaginales

Spéculum vaginaux, Valves vaginales
Specoli vaginali, Valve vaginali

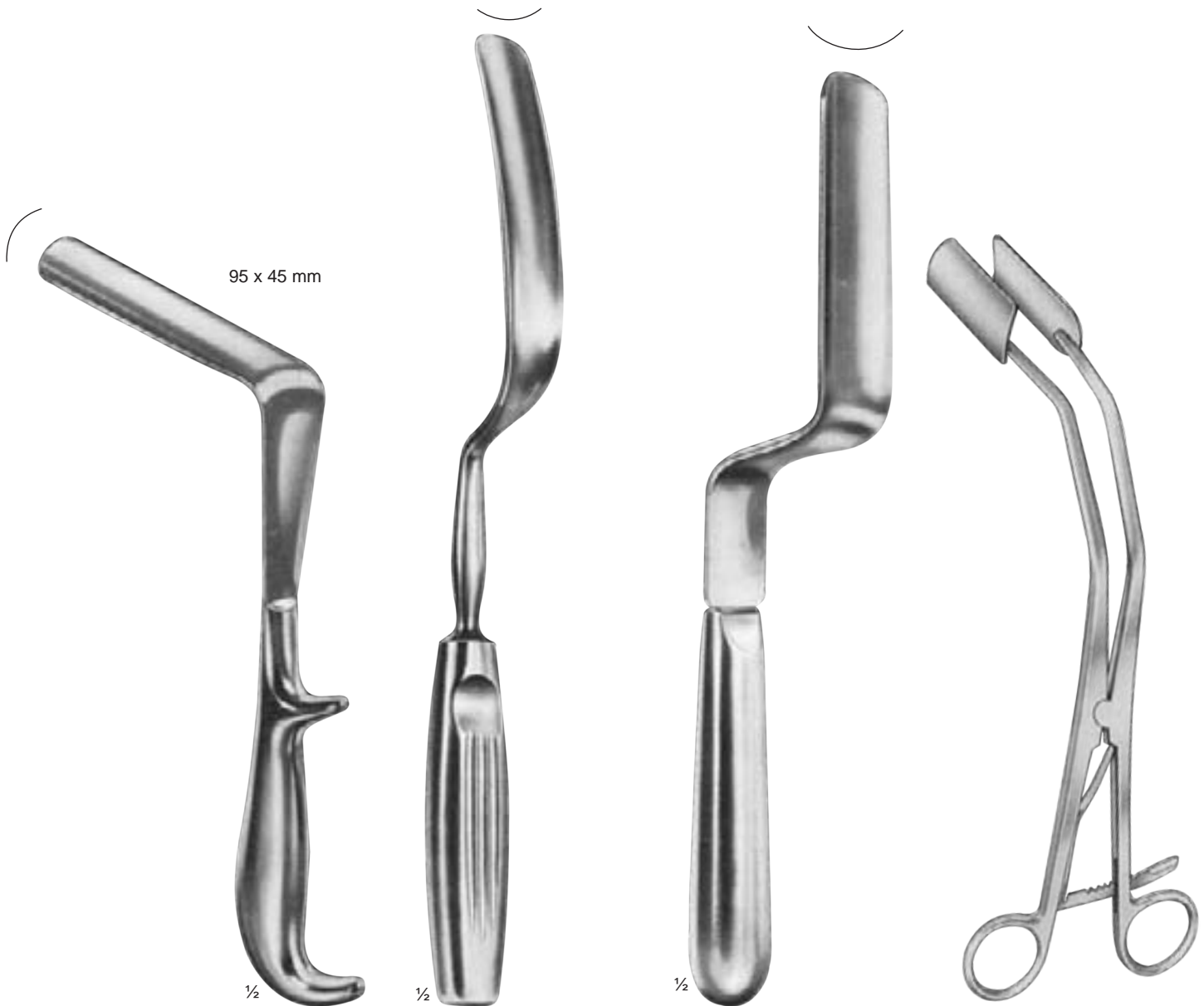

95 x 45 mm

½

½

½

Dunkel
33-160-22

Breisky
33-163-20 - 33-165-40

Landau
33-168-01 - 33-168-02
33-168-01 = 105 x 28 mm
33-168-02 = 105 x 38 mm

New Port
33-170-00
25 cm / 10"

33-163-20 = 100 x 20 mm
33-163-25 = 100 x 25 mm
33-163-30 = 100 x 30 mm
33-163-35 = 100 x 35 mm
33-163-40 = 100 x 40 mm

33-164-20 = 130 x 20 mm
33-164-25 = 130 x 25 mm
33-164-30 = 130 x 30 mm
33-164-35 = 130 x 35 mm
33-164-40 = 130 x 40 mm

33-165-40 = 155 x 40 mm



Vaginal Specula, Vaginal Retractors

Vaginalspekula, Scheidenhalter
Especulos vaginales, Valvas vaginales

Spéculum vaginaux, Valves vaginales
Specoli vaginali, Valve vaginali

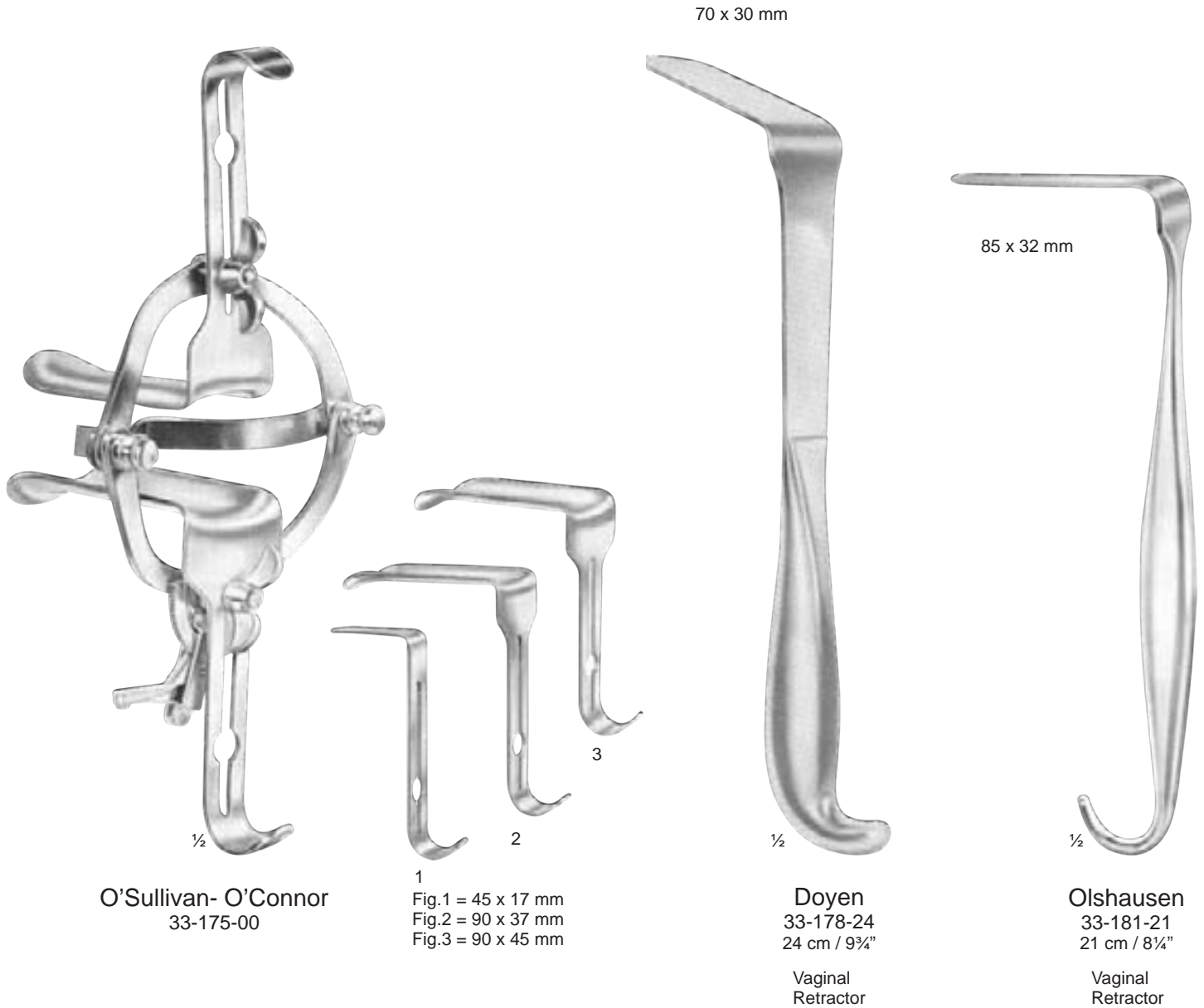

O'Sullivan- O'Connor
33-175-00

1
Fig.1 = 45 x 17 mm
Fig.2 = 90 x 37 mm
Fig.3 = 90 x 45 mm

Doyen
33-178-24
24 cm / 9 3/4"

Vaginal Retractor

Olshausen
33-181-21
21 cm / 8 1/4"

Vaginal Retractor

- Vaginal Speculum, for examination and operative work, self-retaining, with adjustable frame, Loktiite ratchet, 2 mobile lateral valves, and 3 interchangeable blades fig. 1-3

Endocervical Specula, Vaginal Retractors

Endospekula, Scheidenhalter
 Espéculos endocervicales, Valvas vaginales

Endospéculums, Valves vaginales
 Endospecoli, Valve vaginali



Kogan
 33-187-24
 24 cm / 9½"



Kogan
 33-189-24
 24 cm / 9½"



Kogan
 24 cm / 9½"
 33-191-03 = 3 mm
 33-191-07 = 7 mm



Friedman / Blair Bell
 33-193-10
 10 cm / 4"



Uterine Dilators

Uterusdilatoren
Dilatadores uterinos

Dilateurs du col de l' utérus
Dilatatori uterini

mm ø with sloped handle

1.0	33-198-01
2.0	33-198-02
3.0	33-198-03
4.0	33-198-04
5.0	33-198-05
6.0	33-198-06
7.0	33-198-07
8.0	33-198-08
9.0	33-198-09
10.0	33-198-10
11.0	33-198-11
12.0	33-198-12
13.0	33-198-13
14.0	33-198-14
15.0	33-198-15
16.0	33-198-16
17.0	33-198-17
18.0	33-198-18
19.0	33-198-19
20.0	33-198-20
21.0	33-198-21
22.0	33-198-22
23.0	33-198-23
24.0	33-198-24
25.0	33-198-25
26.0	33-198-26



½

Hegar

33-198-01 - 33-198-26
33-201-01 - 33-201-19
with very conical point

mm ø with sloped handle

1.5	33-201-01
2.5	33-201-02
3.5	33-201-03
4.5	33-201-04
5.5	33-201-05
6.5	33-201-06
7.5	33-201-07
8.5	33-201-08
9.5	33-201-09
10.5	33-201-10
11.5	33-201-11
12.5	33-201-12
13.5	33-201-13
14.5	33-201-14
15.5	33-201-15
16.5	33-201-16
17.5	33-201-17
18.5	33-201-18
19.5	33-201-19

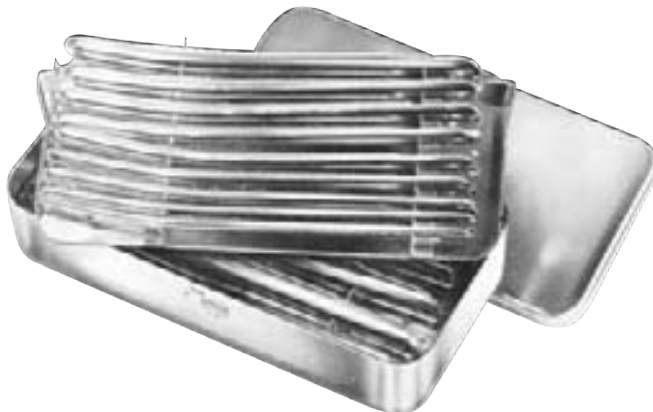

33-198-84 Set of 14 dilators 33-198-04 - 33-198-17
(4.0-17.0 mm ø), in metal case with hinged lid.
33-198-94 Set of 26 dilators 33-198-01 - 33-198-26
(1.0-26.0 mm ø), in metal case with hinged lid.



Uterine Dilators

Uterusdilatoren
Dilatadores uterinos

Dilatateurs du col de l'utérus
Dilatatori uterini



1/2

mm ø	
1.0/ 2.0	33-206-02
3.0/ 4.0	33-206-04
5.0/ 6.0	33-206-06
7.0/ 8.0	33-206-08
9.0/ 10.0	33-206-10
11.0/ 12.0	33-206-12
13.0/14.0	33-206-14
15.0/16.0	33-206-16
17.0/18.0	33-206-18
19.0/20.0	33-206-20
21.0/22.0	33-206-22
23.0/24.0	33-206-24
25.0/26.0	33-206-26

Hegar

33-206-02 - 33-206-26

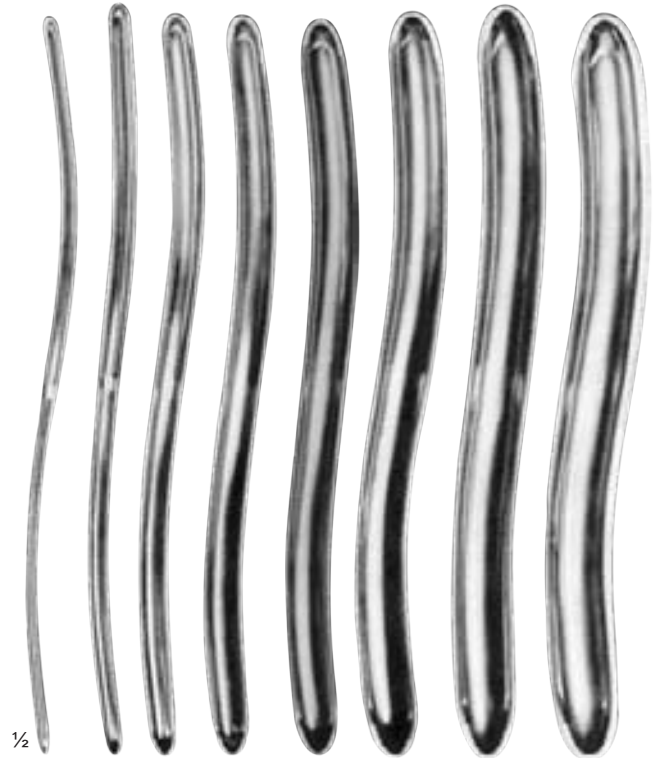

1/2

Hegar

33-206-80

Set of 8 dilators 3.0/4.0-17.0/18.0 mm ø

33-206-90

Set of 13 dilators 1.0/2.0-25.0/26.0 mm ø

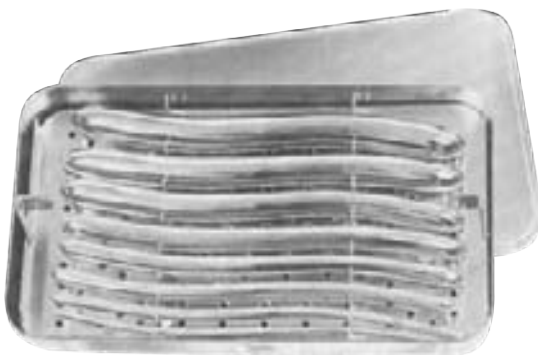

33-206-84

Set of 8 dilators 3.0/4.0-17.0/18.0 mm ø
in metal case with hinged lid

33-206-94

Set of 13 dilators 1.0/2.0-25.0/26.0mm ø
in metal case with hinged lid

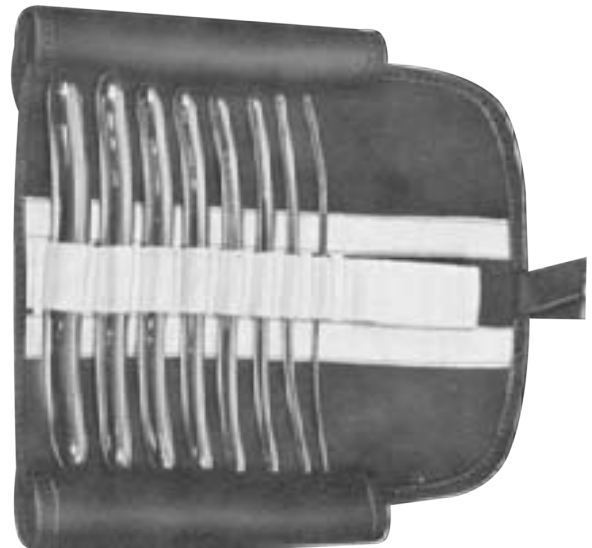

33-206-82

Set of 8 dilators 3.0/4.0-17.0/18.0 mm ø
in boilable canvas roll

Uterine Dilators

Uterusdilatoren
Dilatadores uterinos

Dilatateurs du col de l'utérus
Dilatatori uterini



Hank

- Fig. 9/10 33-210-10 = 4.5/5 mm
- Fig. 11/12 33-210-12 = 5.5/6 mm
- Fig. 13/14 33-210-14 = 6.5/7 mm
- Fig. 15/16 33-210-16 = 7.5/8 mm
- Fig. 17/18 33-210-18 = 8.5/9 mm
- Fig. 19/20 33-210-20 = 9.5/10 mm



Hank
33-210-10
33-210-20



Hank
33-210-80
set of 6 Pieces

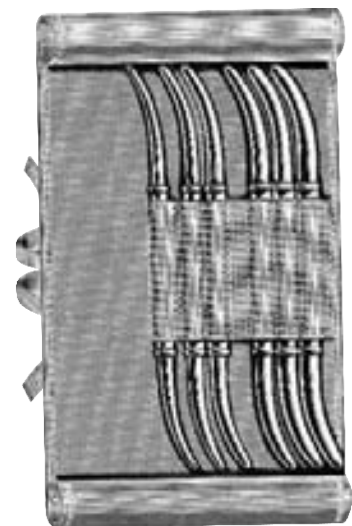

Hank
33-210-82
set of 6 pieces
in canvas roll



Uterine Dilators

Uterusdilatoren
Dilatadores uterinos

Dilateurs du col de l'utérus
Dilatatori uterini



- 33-216-03 = 3/6 mm diam
- 33-216-04 = 4/7 mm diam
- 33-216-05 = 5/8 mm diam
- 33-216-06 = 6/9 mm diam
- 33-216-07 = 7/10 mm diam
- 33-216-08 = 8/11 mm diam
- 33-216-09 = 9/12 mm diam
- 33-216-10 = 10/13 mm diam
- 33-216-11 = 11/14 mm diam
- 33-216-12 = 12/15 mm diam
- 33-216-13 = 13/16 mm diam
- 33-216-14 = 14/17 mm diam
- 33-216-15 = 15/18 mm diam
- 33-216-16 = 16/19 mm diam
- 33-216-17 = 17/20 mm diam
- 33-216-18 = 18/21 mm diam
- 33-216-00 = Set of 16
Uterine Dilators

Hawkin Ambler
33-216-03 - 33-216-18
17.5 cm / 7"



- 33-235-01 Size 1 = ø 3 to 7 mm
- 33-235-02 Size 2 = ø 5 to 9 mm
- 33-235-03 Size 3 = ø 7 to 12 mm
- 33-235-04 Size 4 = ø 9 to 15 mm
- 33-235-05 Size 5 = ø 12 to 18 mm
- 33-235-06 Size 6 = ø 15 to 21 mm
- 33-235-07 Size 7 = ø 18 to 24 mm
(available only by sets)

Jolly
Uterine Dilators,
cone shaped

- 33-235-00 Set of 5, containing
1 of each size 1 to 5
- 33-235-08 Set of 7, containing
1 of each size 1 to 7



- 33-238-13 Size13/15 = (4½ + 5 mm)
- 33-238-17 Size17/19 = (5¾ + 6½ mm)
- 33-238-21 Size21/23 = (7 + 7 ¾ mm)
- 33-238-25 Size25/27 = (8¾ + 9 mm)
- 33-238-29 Size29/31 = (9¾ + 10 mm)
- 33-238-33 Size33/35 = (11 + 11¾ mm)
- 33-238-37 Size37/39 = (12 + 13 mm)
- 33-238-41 Size41/43 = (13¾ + 14¼ mm)
- 33-238-45 Size45/47 = (15+15¾ mm)
- 33-238-49 Size49/51 = (16¾ + 17 mm)
- 33-238-53 Size53/55 = (17¾+ 18¾ mm)
- 33-238-57 Size57/59 = (19 + 19¾ mm)
- 33-238-42 Set of 8 PRATT Uterine
Dilators, double-ended.
sizes 13/15 to 41/43
in canvas roll

Pratt
Uterine Dilators,
double-ended



- 33-241-01 = 3-5 mm diam
- 33-241-02 = 4-6 mm diam
- 33-241-03 = 5-7 mm diam
- 33-241-04 = 6-8 mm diam
- 33-241-05 = 7-9 mm diam
- 33-241-06 = 8-10 mm diam
- 33-241-07 = 9-11 mm diam
- 33-241-08 = 10-12 mm diam
- 33-241-09 = 11-13 mm diam
- 33-241-10 = 12-14 mm diam
- 33-241-11 = 13-15 mm diam
- 33-241-12 = 14-16 mm diam
- 33-241-13 = 15-17 mm diam
- 33-241-14 = 16-18 mm diam
- 33-241-15 = 17-19 mm diam
- 33-241-16 = 18-20 mm diam

Bonney Barker
33-241-00
(Set of 16 in box)

Uterine Dilators

Uterusdilatoren
Dilatadores uterinos

Dilatateurs du col de l'utérus
Dilatatori uterini

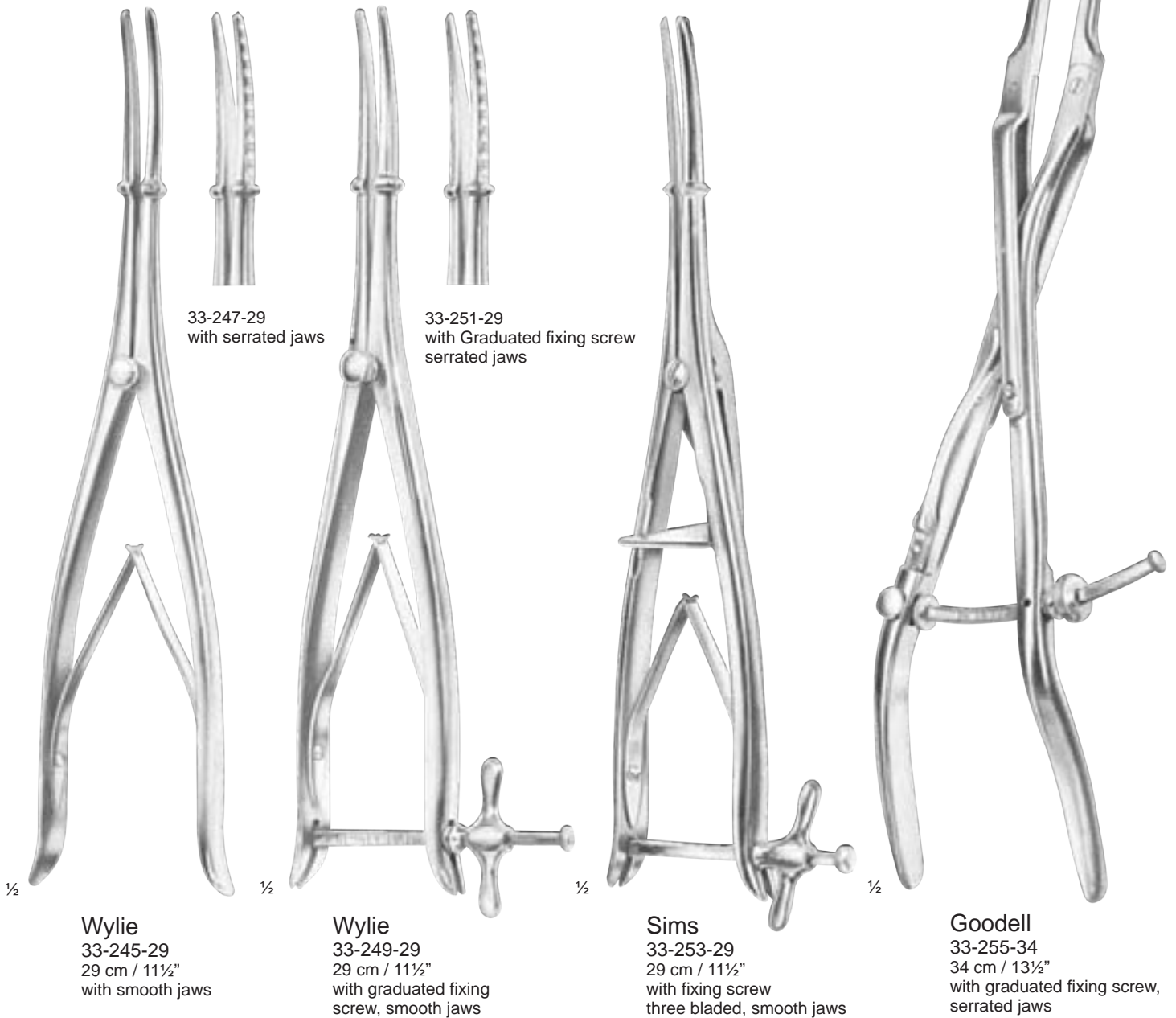

33-247-29
with serrated jaws

33-251-29
with Graduated fixing screw
serrated jaws

Wylie
33-245-29
29 cm / 11½"
with smooth jaws

Wylie
33-249-29
29 cm / 11½"
with graduated fixing
screw, smooth jaws

Sims
33-253-29
29 cm / 11½"
with fixing screw
three bladed, smooth jaws

Goodell
33-255-34
34 cm / 13½"
with graduated fixing screw,
serrated jaws

Uterine Sounds

Uterussonden
Histerómetros

Hystéromètres
Isterometri



5 mm



1/2

Mayo
33-261-33
33 cm / 13"
malleable

4 mm



1/2

Galabins
33-263-29
29.5 cm / 11 3/4"
malleable



1/2

Simpson
33-266-31
31 cm / 12 1/2"
malleable
silver-plated



1/2

Valleix
33-269-25
25 cm / 10"
graduated with slider

3 mm



1/2

Collin
33-271-28
28 cm / 11"



1/2

Martin
33-273-32 = rigid =
33-274-32 =malleable=
32 cm / 12 1/2"

4 mm



1/2

Sims
33-277-32
33-278-32
32 cm / 12 1/2"



Uterine Sounds, Uterine Depressor

Uterussonden, Uterusdepressor
Histerómetros, Depresor uterino

Hystéromètres, Dépresseur utérin
Isterometri, Depressore uterino



Horrocks
33-282-30
(Malleable-SP)
30 cm / 12"



Ramathibodi
33-285-27
27.5 cm / 11"

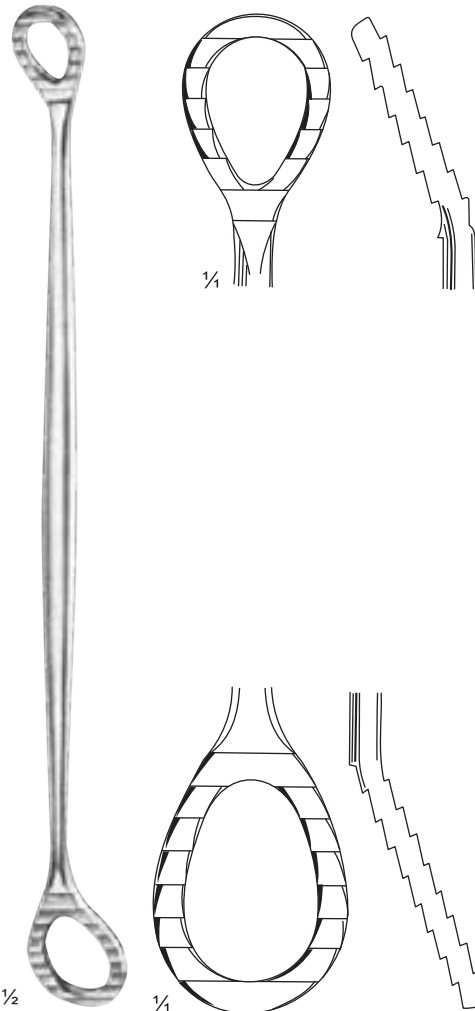

Sims
33-287-26
26 cm / 10¼"



Braun
33-289-28
28 cm / 11"

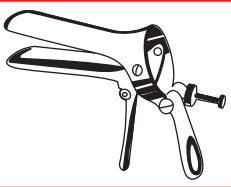

Uterine Tenaculum Forceps

Hakenzangen
Pinza para cuello uterino

Pince pour le col de l' utérus
Pinza per il collo dell' utero



1/3

Staude-Moore
33-294-17
17 cm / 6 3/4"



1/3

Barrett
33-296-18
18 cm / 7"



1/3

Pozzi
33-298-26
25.5 cm / 10 1/4"



1/3

Schroeder
23 cm / 9" 33-300-23
25 cm / 10" 33-300-25



1/3

Braun
33-302-25
25 cm / 10"



1/3

Duplay
33-305-28
28 cm / 11"

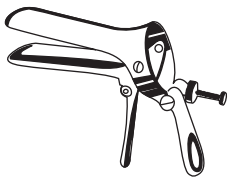

Uterine Tenaculum Forceps, Amniotome

Hakenzangen, Amniotom
Pinza para cuello uterino, Amniótomo

Pince pour le col de l' utérus, Amniotome
Pinza per il collo dell' utero, Amniotomo



Beacham
33-311-26
26 cm / 10 1/4"



Skene
33-313-24
24 cm / 9 1/2"



Abel
33-316-27
27 cm / 10 1/2"

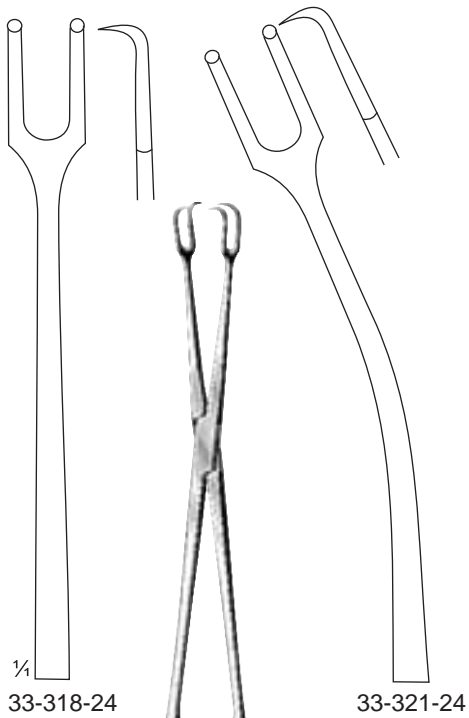

Schroeder
33-318-24 - 33-321-24
24 cm / 9 1/2"



Teale
33-323-18 = 18 cm / 7"
33-323-23 = 23 cm / 9"

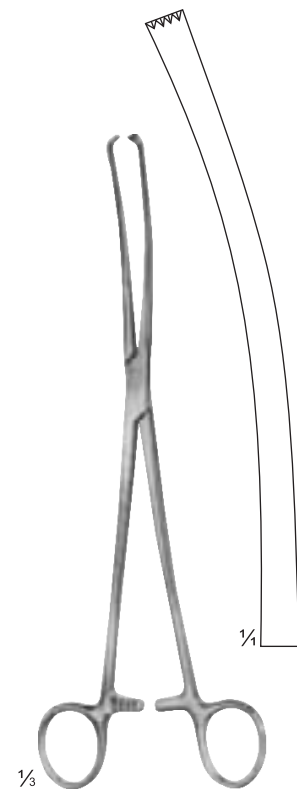

Iowa
33-325-26
26 cm / 10 1/4"



Uterine Tenaculum Forceps

Hakenzangen
Pinza para cuello uterino

Pince pour le col de l' utérus
Pinza per il collo dell' utero

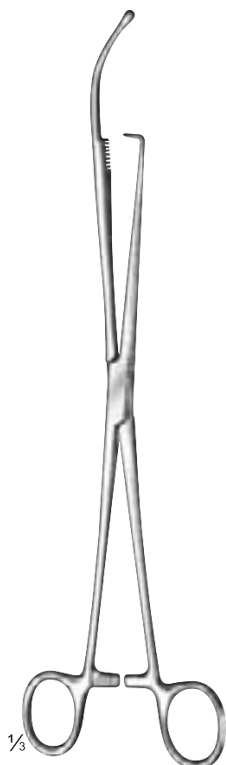

Hulka
33-331-30
28 cm / 11"



Museux-Palmer
33-334-24
24 cm / 9½"



Lewer
33-337-23
23 cm / 9"



Bierer
33-339-23
23 cm / 9"



Pratt
33-342-28
28 cm / 11"

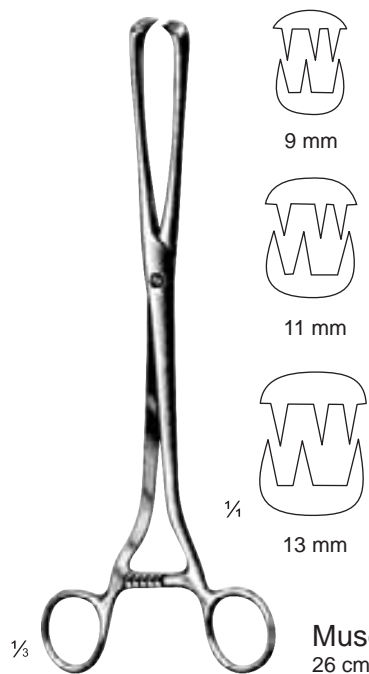

Museux
26 cm / 10¼"

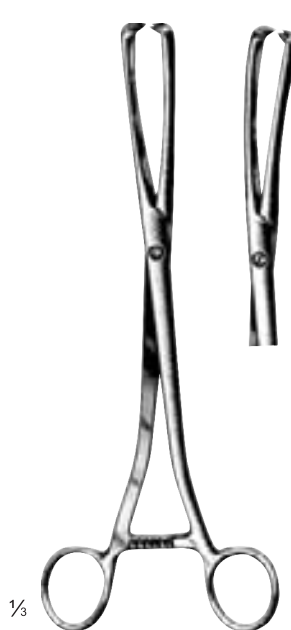

Museux
24 cm / 9½"



Museux
24 cm / 9½"

straight	jaw width	curved sideways
33-344-26	9 mm	33-345-26
33-346-26	11 mm	33-347-26
33-348-26	13 mm	33-349-26

straight	curved sideways	jaw width	straight	curved sideways
33-352-24	33-353-24	6 mm	33-360-24	33-361-24
33-354-24	33-355-24	8 mm	33-362-24	33-363-24
33-356-24	33-357-24	10 mm	33-364-24	33-365-24



Uterine Tenaculum Forceps

Hakenzangen
Pinza para cuello uterino

Pince pour le col de l' utérus
Pinza per il collo dell' utero



Goodwin
33-371-26
26 cm / 10¼"

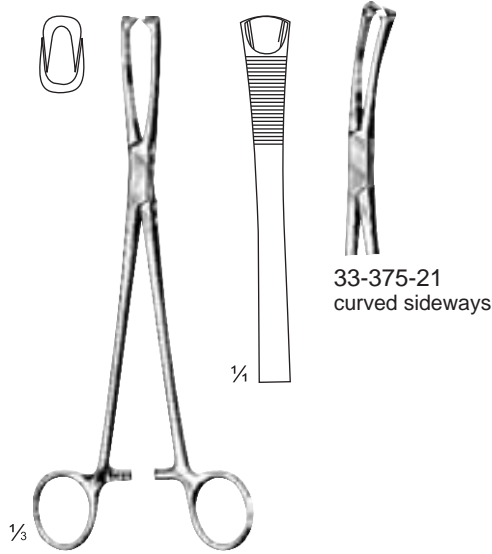

Jacobs
33-374-21 - 33-375-21
21 cm / 8¼"

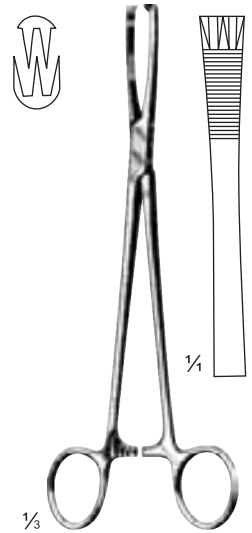

Henrotin
33-378-20
20.5 cm / 8"

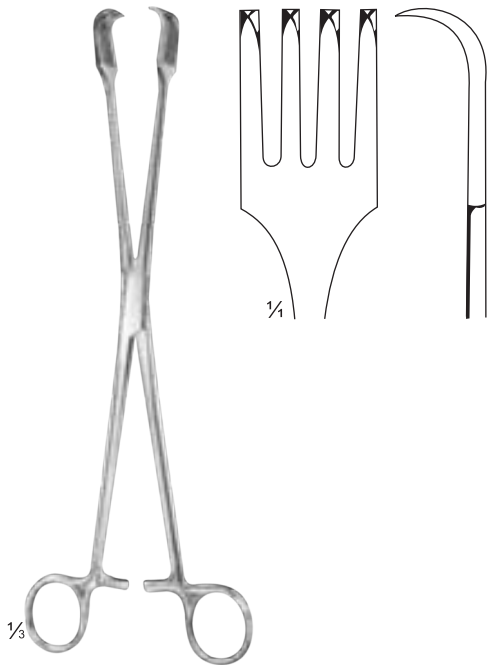

Pratt
33-380-26
26 cm / 10¼"

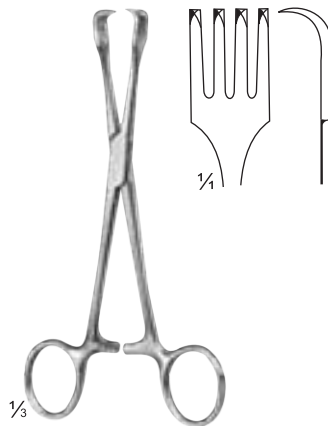

Braun
33-382-16
16 cm / 6¼"

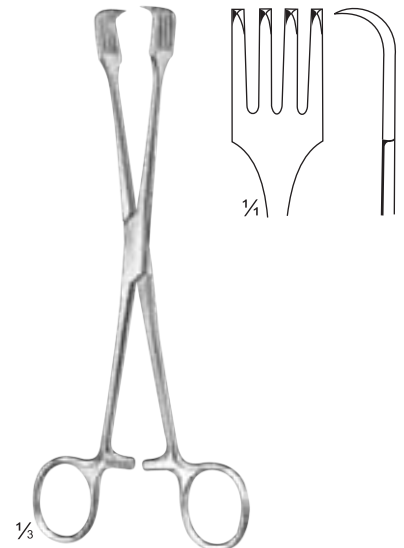

Czerny
33-384-21
20.5 cm / 8¼"



Uterine Polypus Forceps

Uterus-Polypenzangen
Pinzas para pólipos uterinos

Pinces à polypes utérins
Pinze per polipi uterini



Kelly
33-397-32
32 cm / 12½"



Laufe
33-391-20 = 20 cm / 8"
33-391-23 = 23 cm / 9"



Vant
24 cm / 9½" 33-394-24
27 cm / 10½" 33-394-27

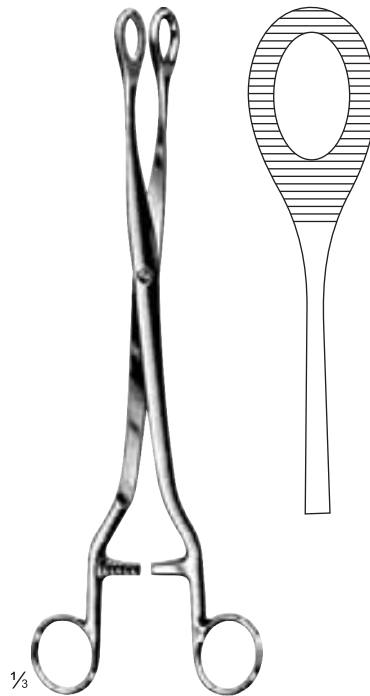

Noto
33-400-27
27 cm / 10½"

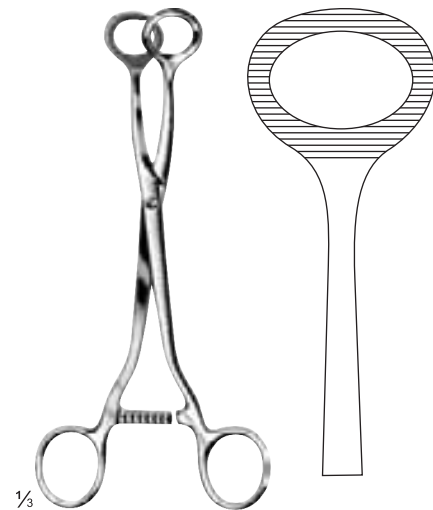

Doyen
33-402-20
20 cm / 8"



Myoma Instruments, Uterine Elevating Forceps

Myom-Instrumente, Uterus-Fasszangen
Instrumentos para fibroma, Pinzas para el útero

Instruments pour fibrome, Pinces hystérolabes
Strumenti per fibromi, Pinze per afferrare l'utero



Doyen
33-407-17
17 cm / 6¾"



Doyen
33-409-17
17 cm / 6¾"

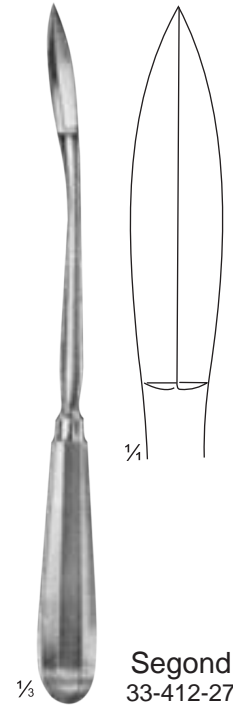

Segond
33-412-27
27 cm / 10½"

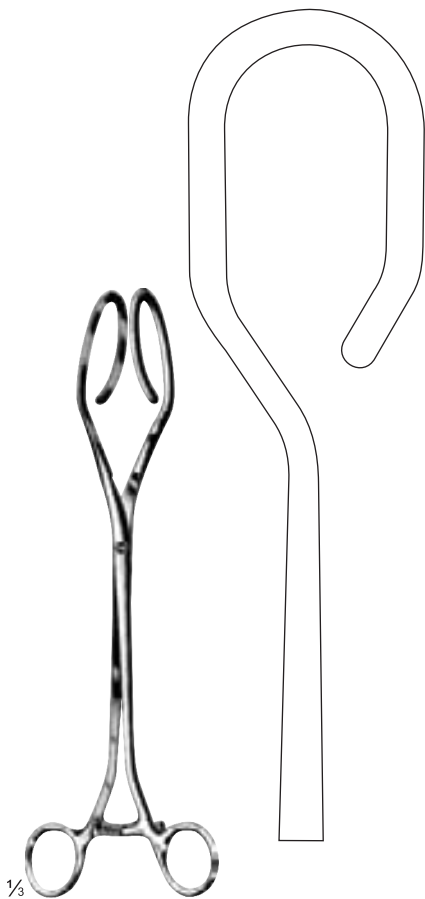

Dartigues
33-415-27
27 cm / 10½"

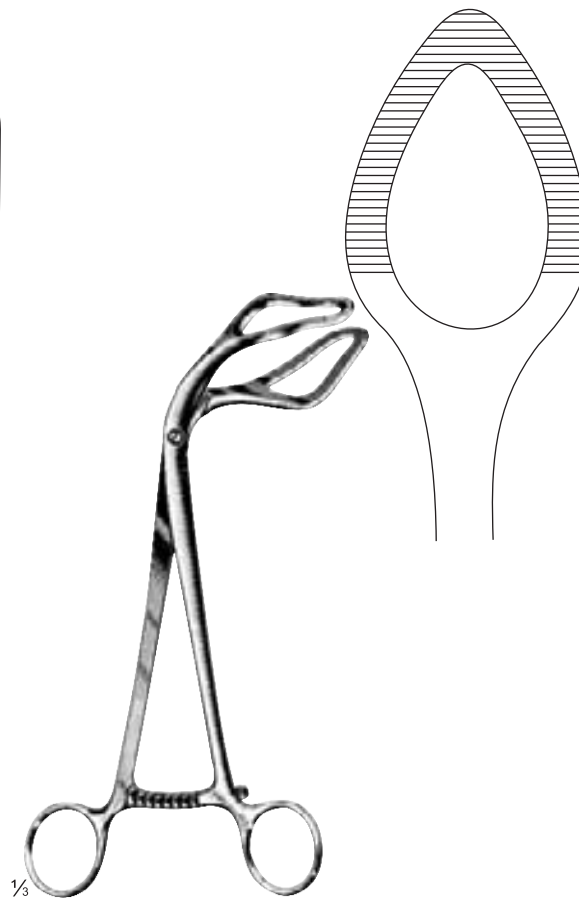

Somer
33-417-23
23 cm / 9"



Collin
33-419-25
25 cm / 10"

Fistula Hooks, Suction Curettes

Fistelhaken, Saugküretten
Ganchos para fístulas, Curetas aspiradoras

Crochets pour fistules, Curettes à aspiration
Uncini per fistole, Curette d'aspirazione

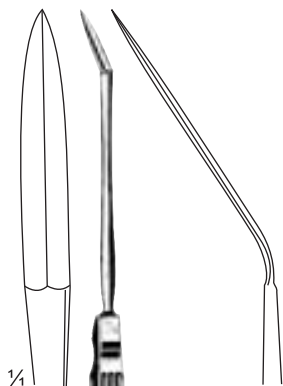

Ayre
33-425-23
23 cm / 9"



Simon
33-428-22
22 cm / 8 3/4"



Simon
33-430-22
22 cm / 8 3/4"



Emmet
22 cm / 8 3/4"



33-432-01



33-432-02



33-432-03



33-432-04



33-432-05

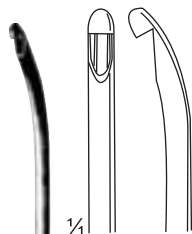

Randall
33-435-24
24 cm / 9 1/2"
4 mm ø



Sherman
33-438-23
23 cm / 9"

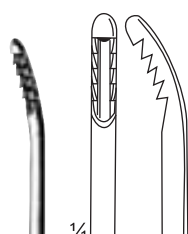

Novak
33-441-23
23 cm / 9"
4 mm ø



33-443-30
6 mm ø

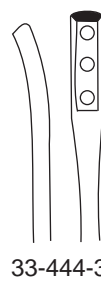

33-444-30
6 mm ø

Kevorkian/younge
33-443-30 - 33-444-30
30 cm / 12"

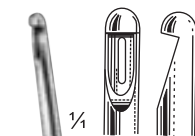

München
33-447-27
27 cm / 10 1/2"



Uterine Biopsy Forceps

Probeexzisionszangen
Pinzas para biopsia

Pinces pour biopsie
Pinze per biopsia



Schubert

33-452-21 = 21 cm / 8¼"
33-452-29 = 29 cm / 11½"



Thoms-Gaylor

33-455-24
24 cm / 9½"



Gellhorn

33-457-23
23 cm / 9"

Faure

33-459-21
21 cm / 8¼"

Uterine Biopsy Forceps

Probeexzisionszangen
Pinzas para biopsia

Pinces pour biopsie
Pinze per biopsia

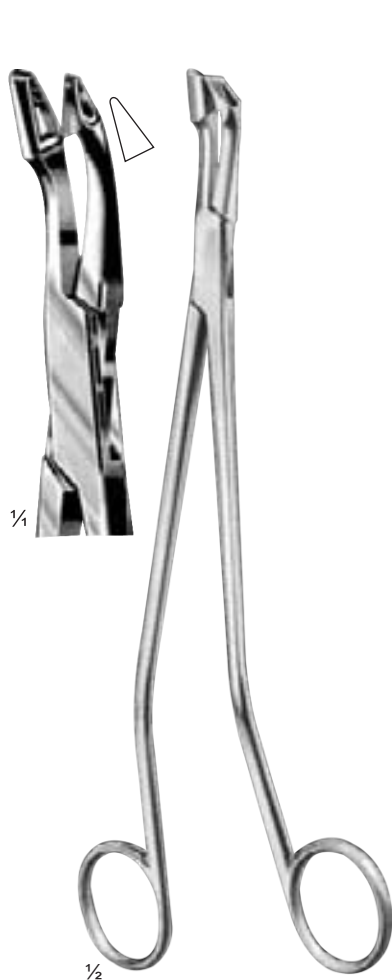

Van Doren
33-465-25
25 cm / 10"



Thoms-Gaylor
33-467-22 = 22 cm / 8½"
33-467-24 = 24 cm / 9½"

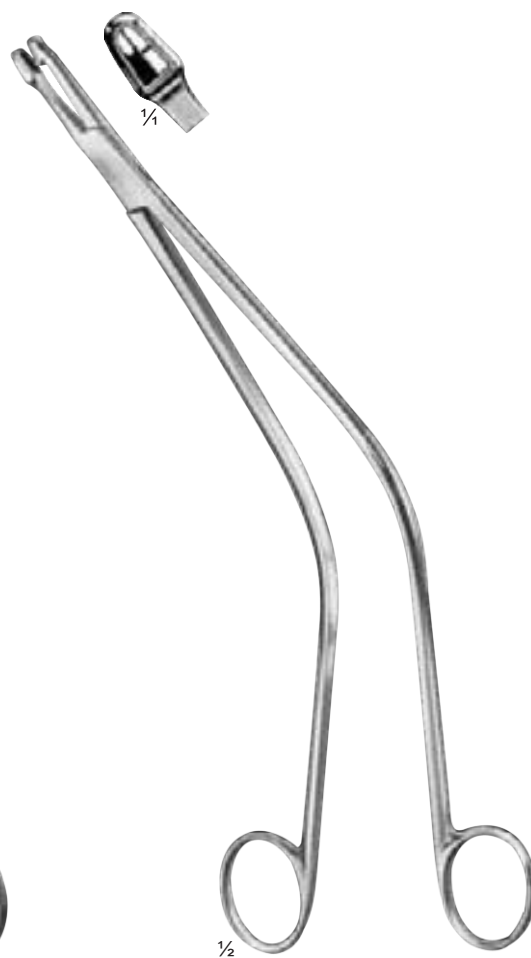

Schubert
33-469-26
26 cm / 10¼"

Uterine Biopsy Forceps

Probeexzisionszangen
Pinzas para biopsia

Pinces pour biopsie
Pinze per biopsia

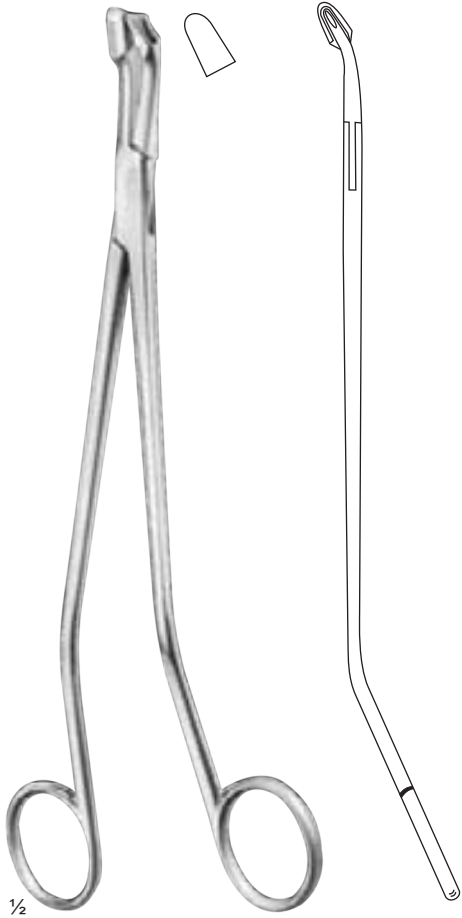
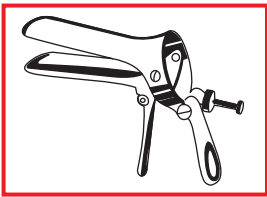

Van Doren
33-473-25
25 cm / 10"



Tischler
33-476-27
27 cm / 10³/₄"

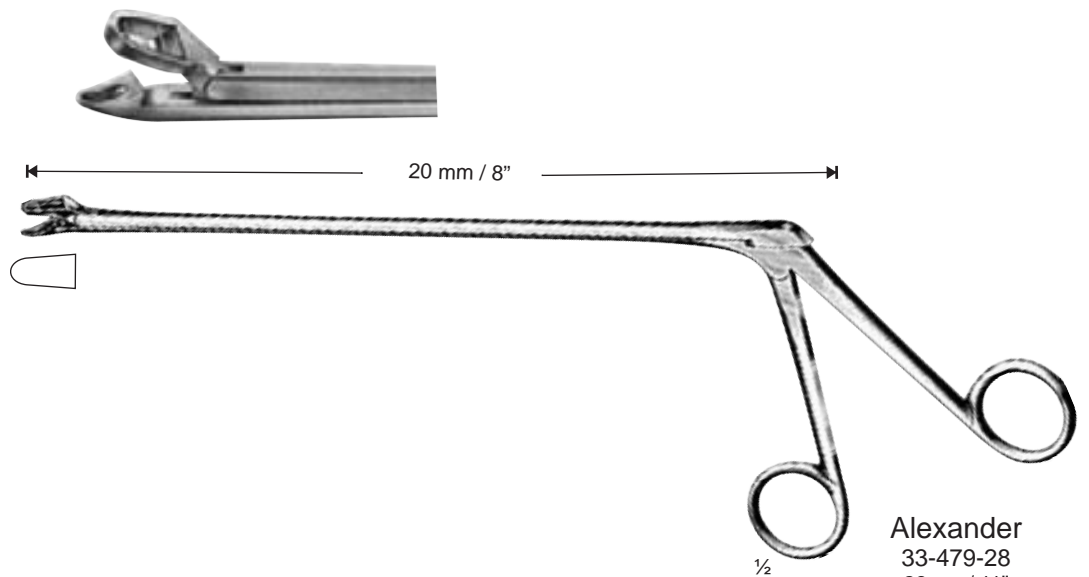

Alexander
33-479-28
28 cm / 11"

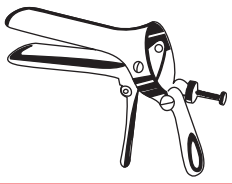

Uterine Biopsy Forceps

Probeexzisionszangen
Pinzas para biopsia

Pinces pour biopsie
Pinze per biopsia

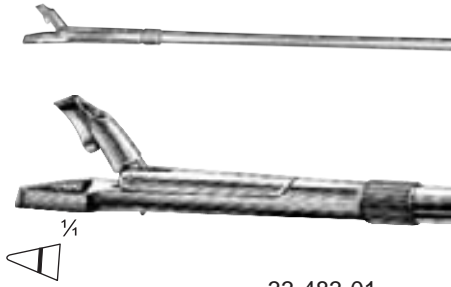

33-483-01



Schumacher
33-483-00

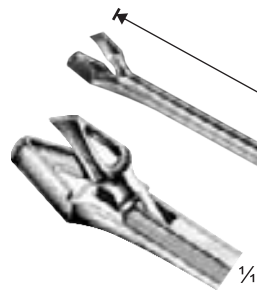

Kevorkian
33-487-32

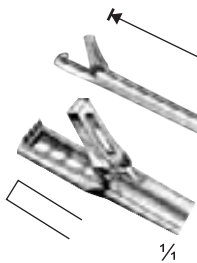

33-485-01

33-485-02

24 mm / 9½"

24.5 mm / 9¾"



Schumacher
33-485-01 - 02



Uterine Biopsy Forceps

Probeexzisionszangen
Pinzas para biopsia

Pinces pour biopsie
Pinze per biopsia

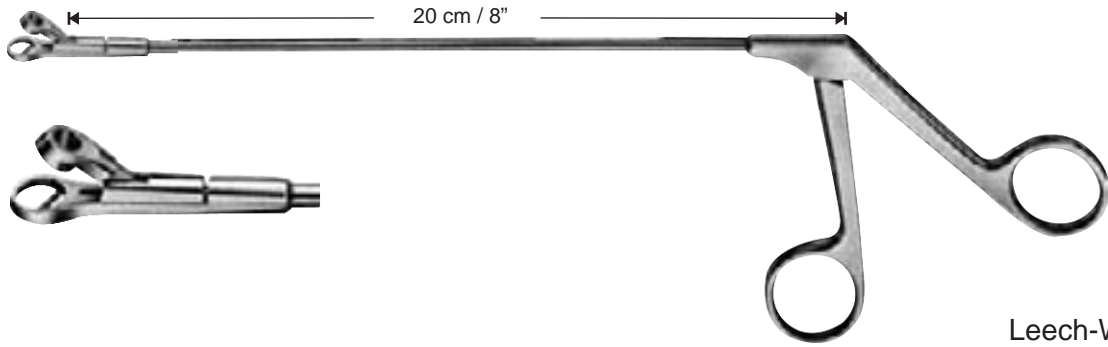

Leech-Wilkinson
33-491-20

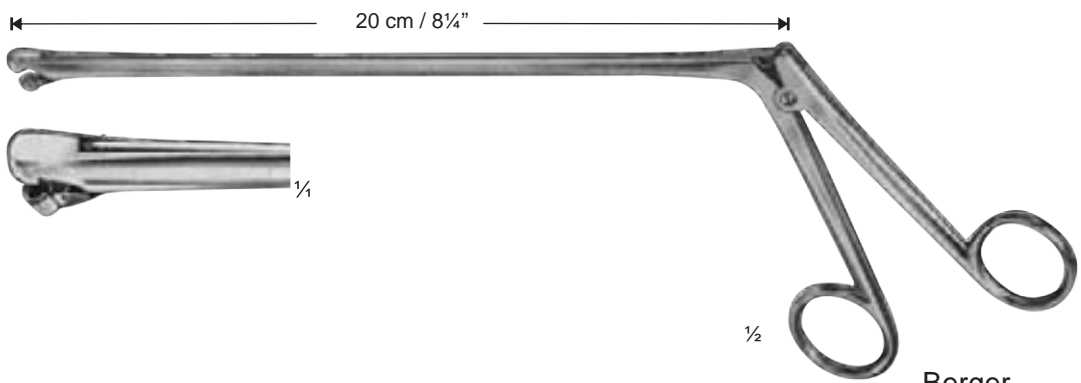

Berger
33-494-20

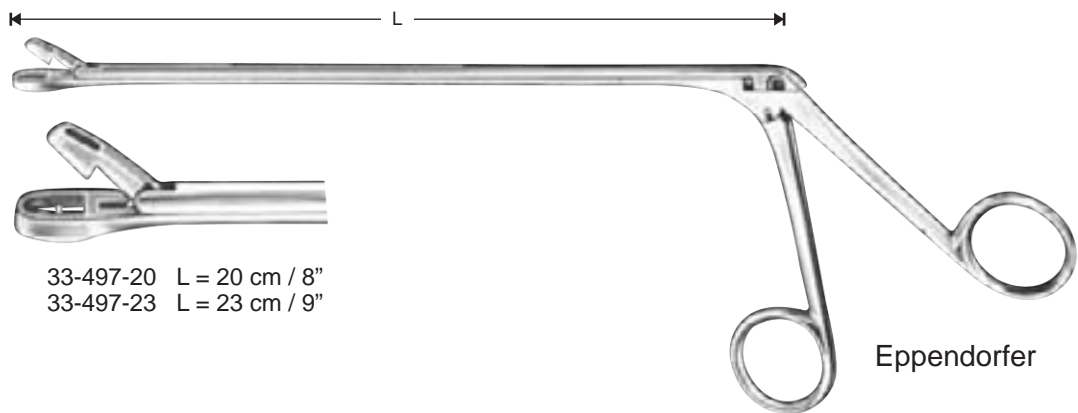

33-497-20 L = 20 cm / 8"
33-497-23 L = 23 cm / 9"

Eppendorfer

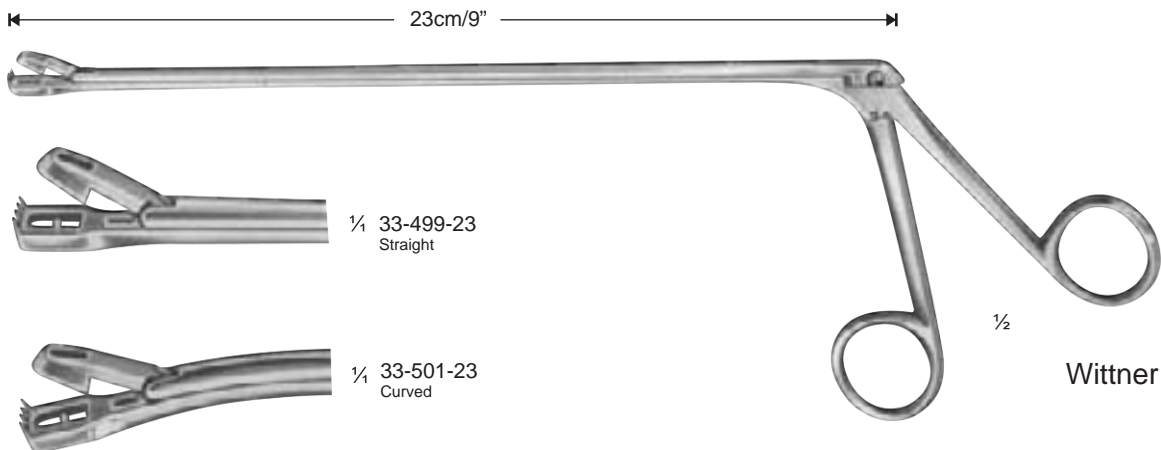

1/4 33-499-23
Straight

1/4 33-501-23
Curved

1/2

Wittner

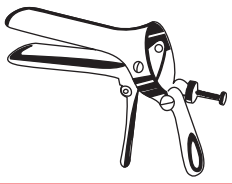

Uterine Biopsy Forceps

Probeexzisionszangen
Pinzas para biopsia

Pinces pour biopsie
Pinze per biopsia

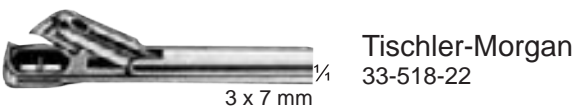
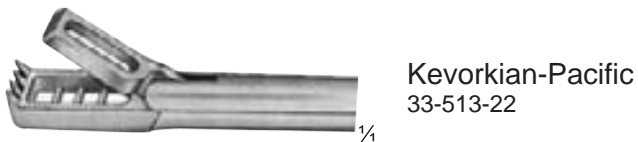
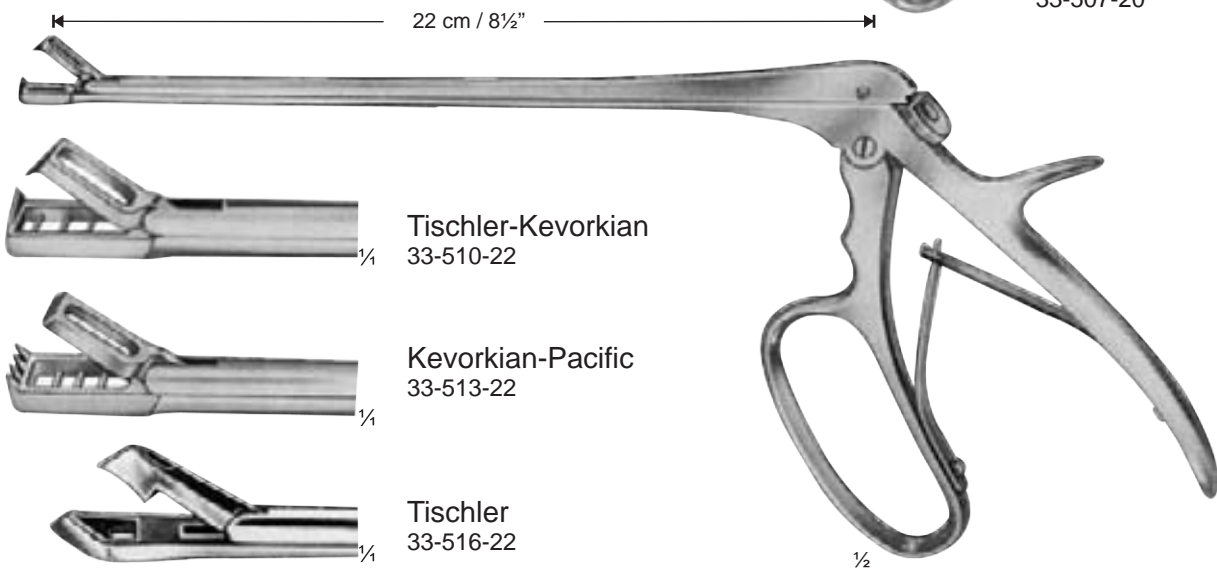
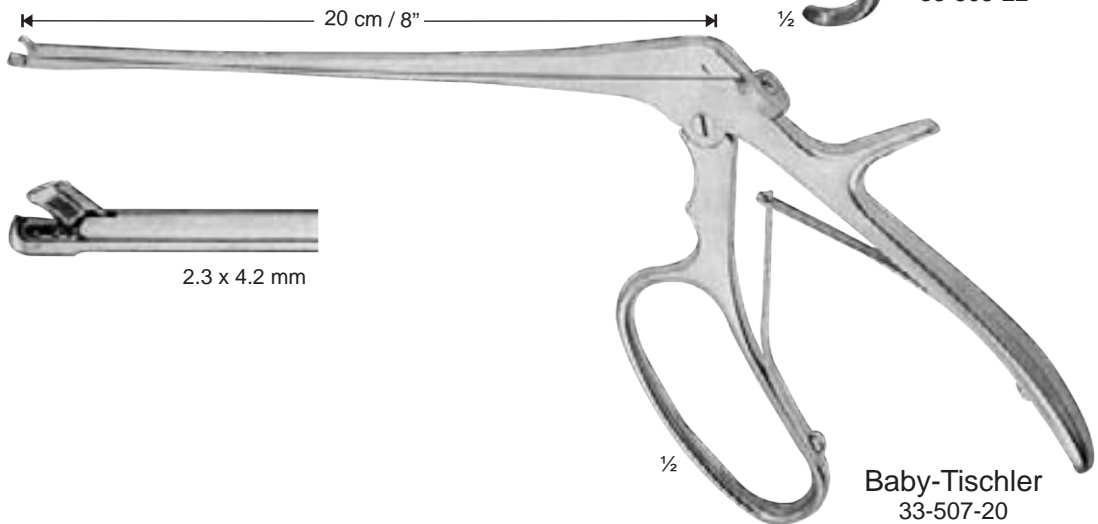
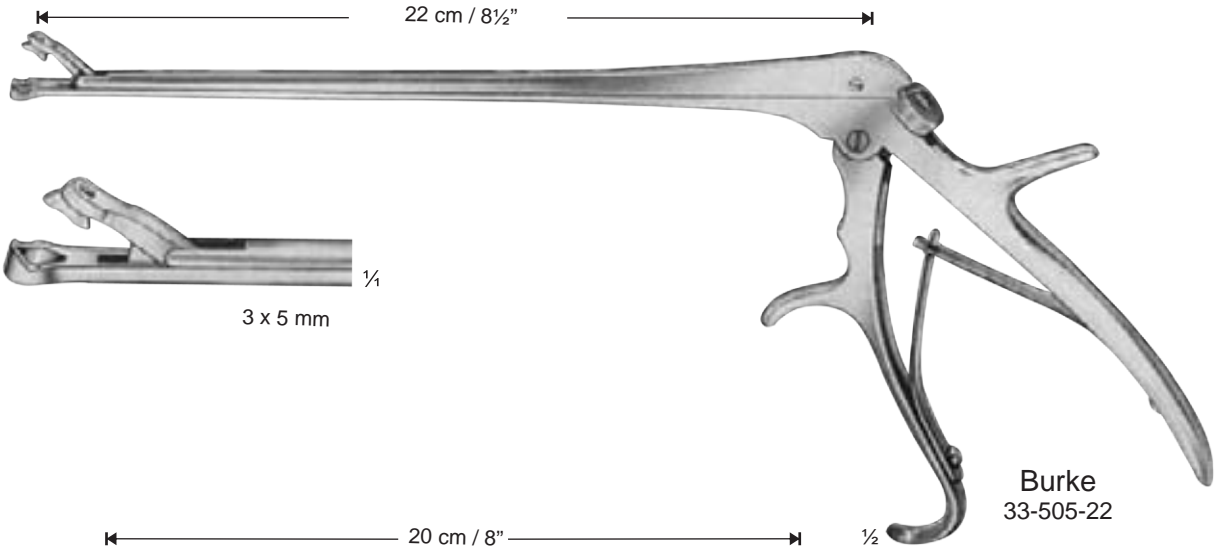



Uterine Curettes

Uterusküretten
Curetas uterinas

Curettes utérines
Curette uterine

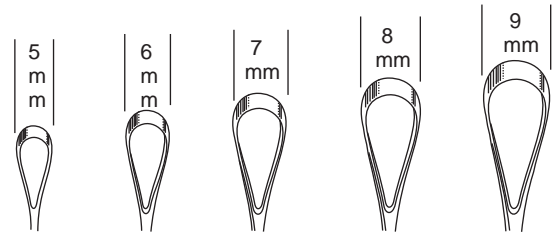
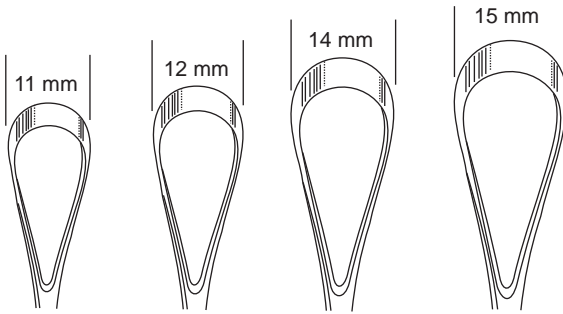

Fig. 00 0 1 2 3



4 5 6 7

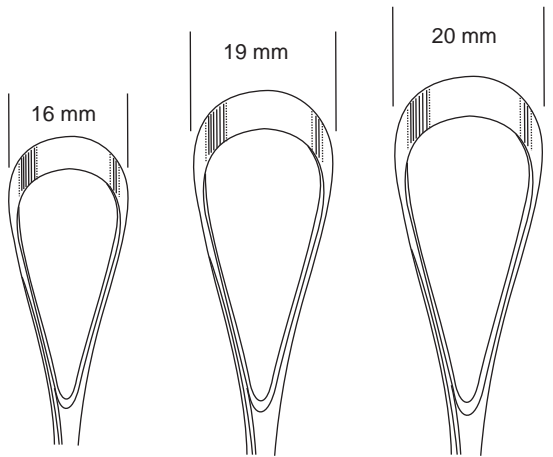
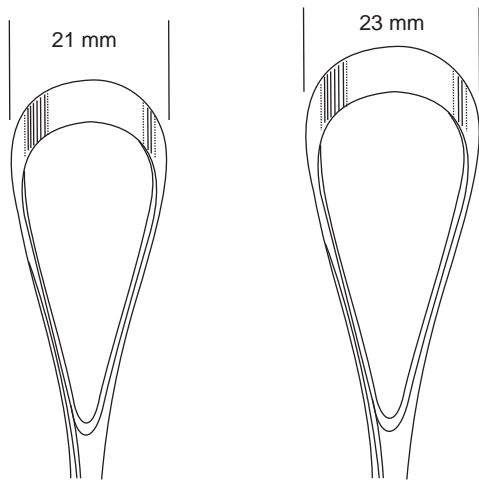

Fig. 8 9 10



11 12



31 cm / 12½"

Recamier/Sims

26 cm / 10½"

Fig.00	33-522-20	33-526-20	33-530-20	33-534-20
Fig.0	33-523-10	33-527-10	33-531-10	33-535-10
Fig.1	33-524-01	33-528-01	33-532-01	33-536-01
Fig.2	33-524-02	33-528-02	33-532-02	33-536-02
Fig.3	33-524-03	33-528-03	33-532-03	33-536-03
Fig.4	33-524-04	33-528-04	33-532-04	33-536-04
Fig.5	33-524-05	33-528-05	33-532-05	33-536-05
Fig.6	33-524-06	33-528-06	33-532-06	33-536-06
Fig.7	33-524-07	33-528-07	33-532-07	33-536-07
Fig.8	33-524-08	33-528-08	33-532-08	33-536-08
Fig.9	33-524-09	33-528-09	33-532-09	33-536-09
Fig.10	33-524-10	33-528-10	33-532-10	33-536-10
Fig.11	33-524-11	33-528-11	33-532-11	33-536-11
Fig.12	33-524-12	33-528-12	33-532-12	33-536-12



Uterine Curettes

Uterusküretten
Curetas uterinas

Curettes utérines
Curette uterine

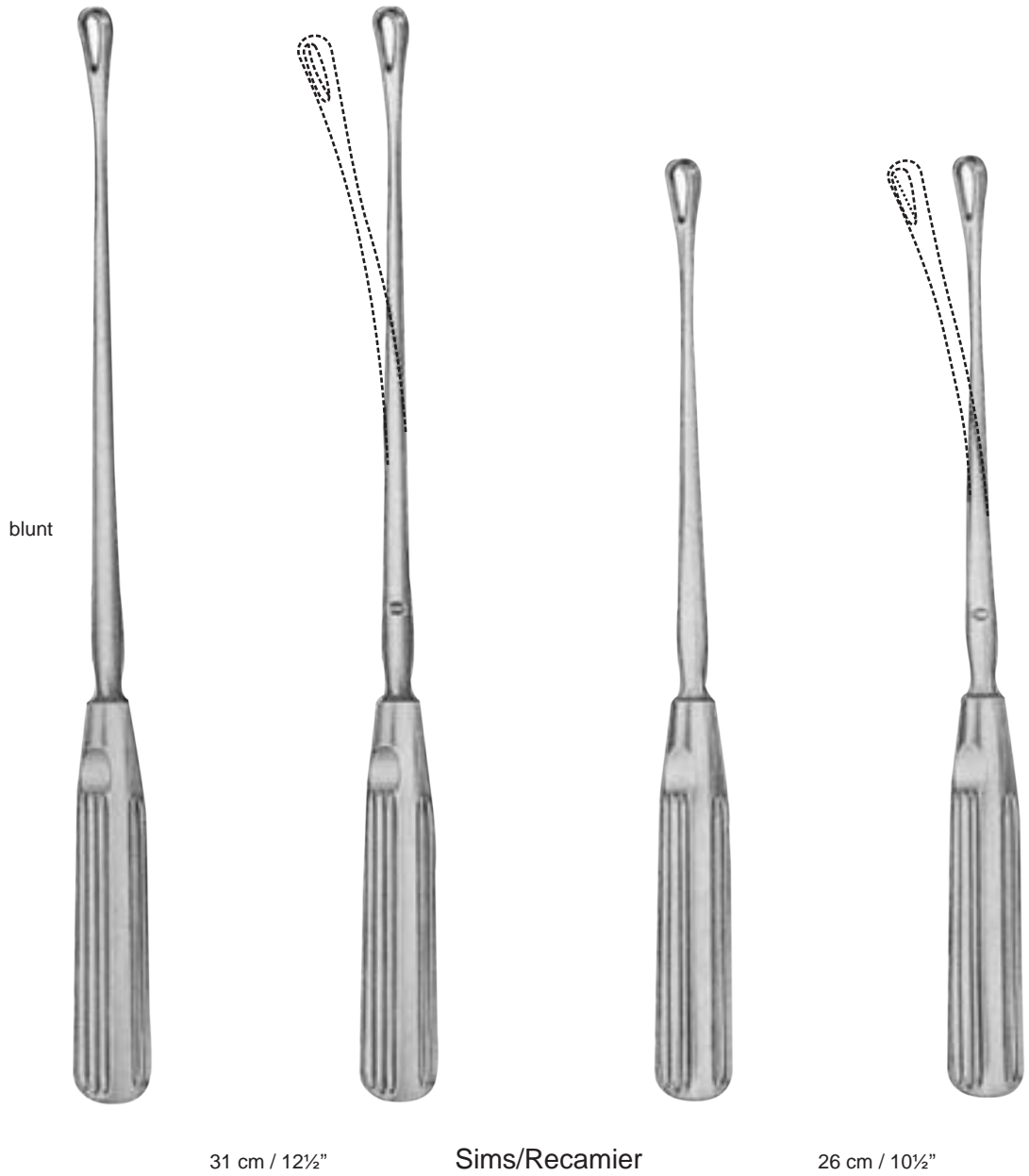

Fig.00	5 mm	33-540-20	33-544-20	33-548-20	33-552-20
Fig.0	6 mm	33-541-10	33-545-10	33-549-10	33-553-10
Fig.1	7 mm	33-542-01	33-546-01	33-550-01	33-554-01
Fig.2	8 mm	33-542-02	33-546-02	33-550-02	33-554-02
Fig.3	9 mm	33-542-03	33-546-03	33-550-03	33-554-03
Fig.4	11 mm	33-542-04	33-546-04	33-550-04	33-554-04
Fig.5	12 mm	33-542-05	33-546-05	33-550-05	33-554-05
Fig.6	14 mm	33-542-06	33-546-06	33-550-06	33-554-06
Fig.7	15 mm	33-542-07	33-546-07	33-550-07	33-554-07
Fig.8	16 mm	33-542-08	33-546-08	33-550-08	33-554-08
Fig.9	19 mm	33-542-09	33-546-09	33-550-09	33-554-09
Fig.10	20 mm	33-542-10	33-546-10	33-550-10	33-554-10
Fig.11	21mm	33-542-11	33-546-11	33-550-11	33-554-11
Fig.12	23 mm	33-542-12	33-546-12	33-550-12	33-554-12



Uterine Curettes

Uterusküretten
Curetas uterinas

Curettes utérines
Curette uterine

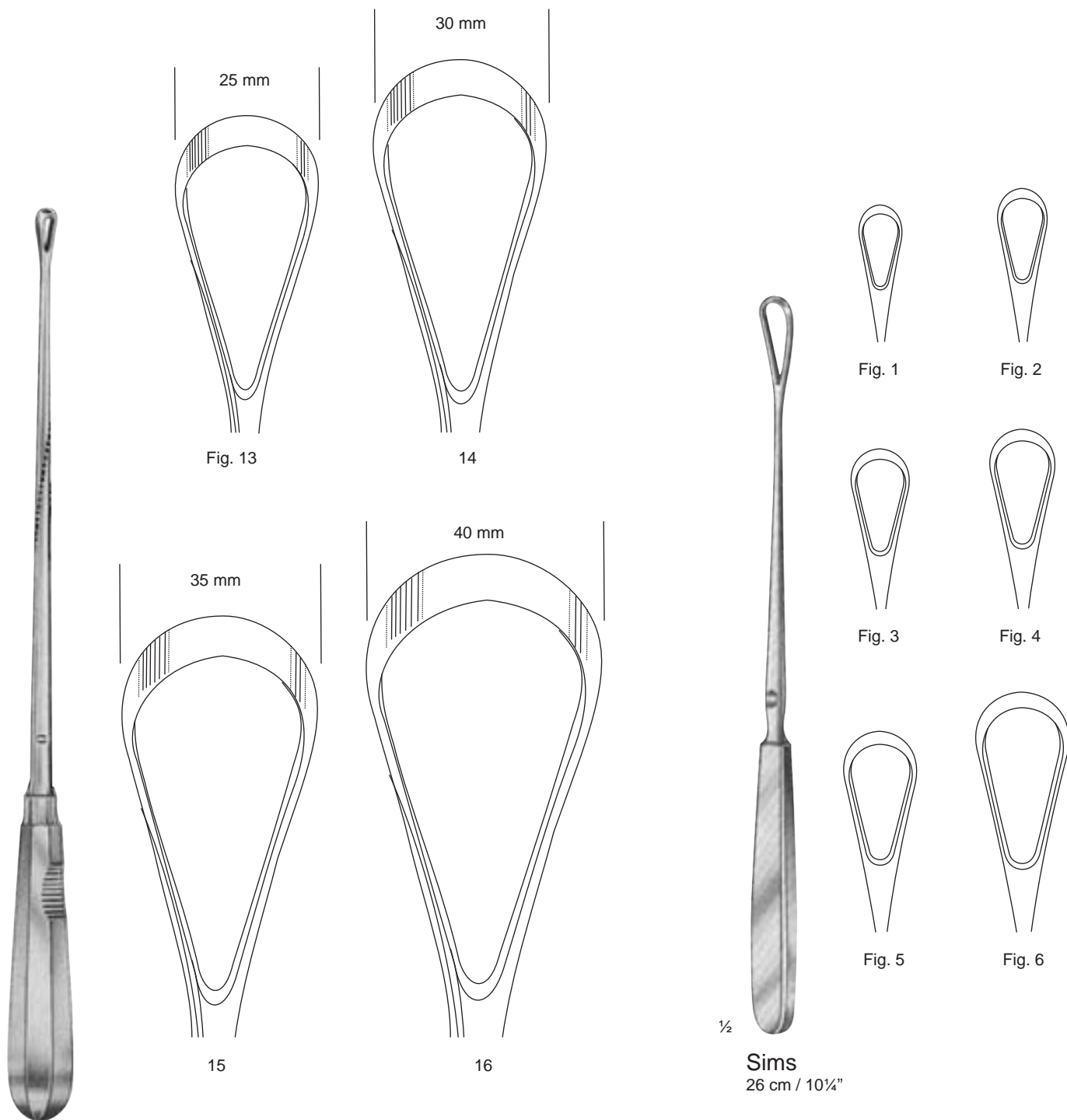

Bumm

Flexible-sharp

Flexible-blunt

33-558-01 Fig 13
33-558-02 Fig 14
33-558-03 Fig 15
33-558-04 Fig 16
34 cm / 13½"

33-559-01
33-559-02
33-559-03
33-559-04
34 cm / 13½"

Sharp

rigid

Sharp

malleable

33-561-01
33-561-02
33-561-03
33-561-04
33-561-05
33-561-06

33-563-01
33-563-02
33-563-03
33-563-04
33-563-05
33-563-06

Fig.

1
2
3
4
5
6

blunt

rigid

33-565-01
33-565-02
33-565-03
33-565-04
33-565-05
33-565-06

blunt

malleable

33-567-01
33-567-02
33-567-03
33-567-04
33-567-05
33-567-06

Uterine Curettes

Uterusküretten
Curetas uterinas

Curettes utérines
Curette uterine

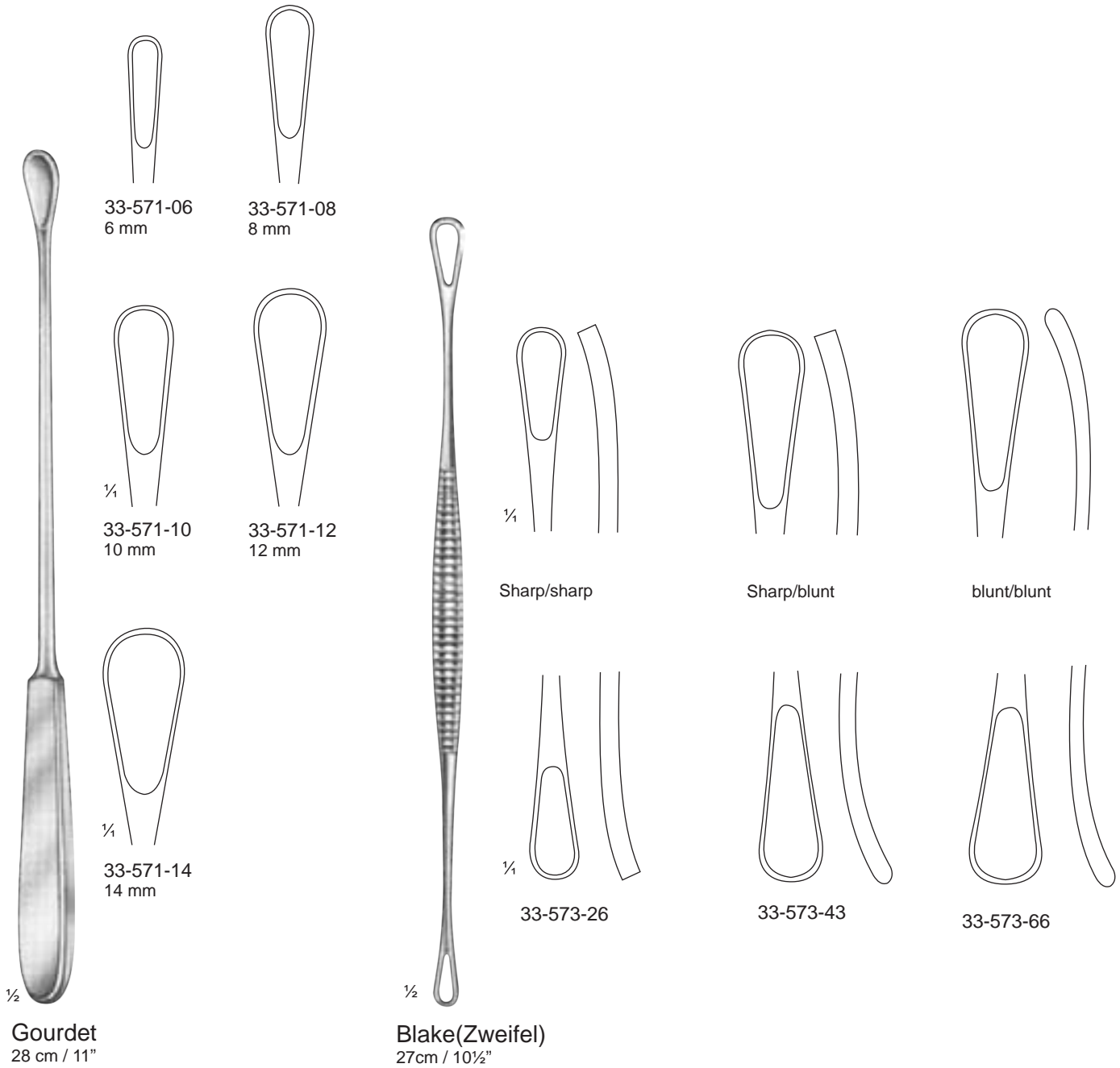

33-571-06
6 mm

33-571-08
8 mm

1/4
33-571-10
10 mm

33-571-12
12 mm

1/4
33-571-14
14 mm

1/4
Sharp/sharp

Sharp/blunt

blunt/blunt

1/4
33-573-26

33-573-43

33-573-66

1/2
Gourdet
28 cm / 11"

1/2
Blake(Zweifel)
27cm / 10 1/2"

Uterine Curettes

Uterusküretten Curettes utérines
Curetas uterinas Curette uterine

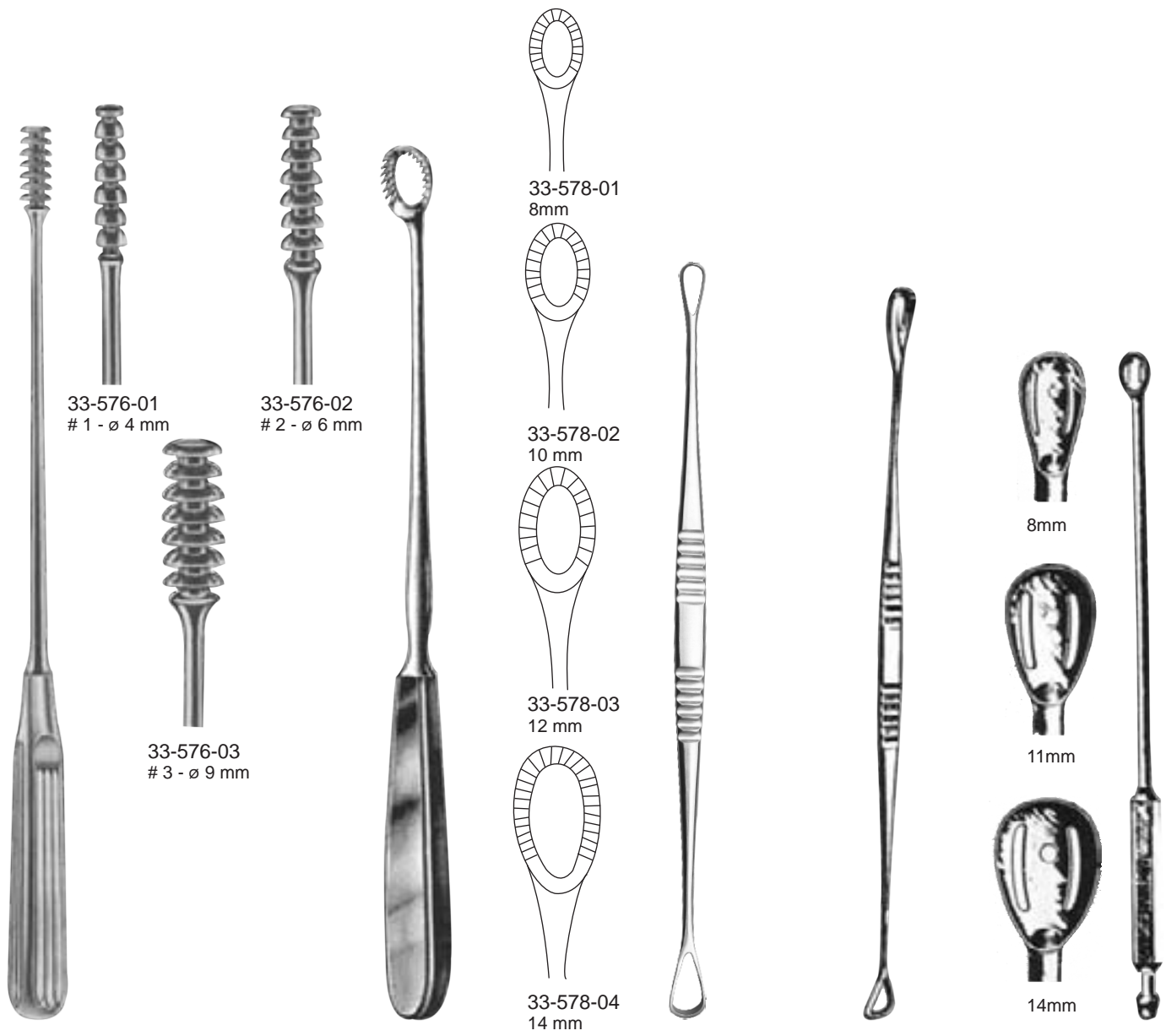

33-576-01
1 - ø 4 mm

33-576-02
2 - ø 6 mm

33-576-03
3 - ø 9 mm

33-578-01
8 mm

33-578-02
10 mm

33-578-03
12 mm

33-578-04
14 mm

8mm

11mm

14mm

Milan
28 cm / 11"

Collin
28 cm / 11"

Sims
(Sh/Bl)
33-581-01 Fig. 1
33-581-02 Fig. 2
33-581-03 Fig. 3
25 cm / 10"

Gervis
(SH/SH)
33-584-26
26 cm / 10¼"

Rheinstadter
(Sharp-CP)
33-587-01 8 mm
33-587-02 11 mm
33-587-03 14 mm

33-578-01 = 8 mm wide
33-578-02 = 10 mm wide
33-578-03 = 12 mm wide
33-578-04 = 14 mm wide

Rheinstadter
(Blunt-CP)
33-588-01 8 mm
33-588-02 11 mm
33-588-03 14 mm
29 cm / 11½"



Uterine Curettes

Uterusküretten
Curetas uterinas

Curettes utérines
Curette uterine



33-591-01
#1 - 10 mm

33-591-02
#2 - 11 mm

33-591-03
#3 - 12 mm

33-591-04
#4 - 13 mm

33-591-05
#5 - 14 mm

33-591-06
#6 - 15 mm

Thomas
blunt, malleable shaft,
28 cm / 11"

- 33-591-01 = Fig. 1
- 33-591-02 = Fig. 2
- 33-591-03 = Fig. 3
- 33-591-04 = Fig. 4
- 33-591-05 = Fig. 5
- 33-591-06 = Fig. 6



33-593-01
10 mm

33-593-02
12 mm

33-593-03
14 mm

Greene
blunt, malleable shaft,
28 cm / 11"

- 33-593-01 10 mm wide
- 33-593-02 12 mm wide
- 33-593-03 14 mm wide

Uterine Scoops

Uteruslöffel

Curettes utérines

Cucharillas y curetas uterinas

Curette uterine



¼

Simon
25 cm / 10"



Fig. 1
33-596-01



Fig. 2
33-596-02



Fig. 3
33-596-03

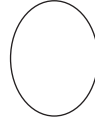

Fig. 4
33-596-04

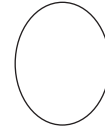

Fig. 5
33-596-05

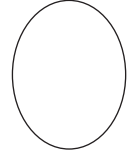

Fig. 6
33-596-06



⅓

Schroeder
30 cm / 12"



Fig. 1
33-598-01



Fig. 2
33-598-02

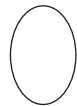

Fig. 3
33-598-03



Fig. 4
33-598-04



Fig. 5
33-598-05

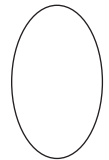

Fig. 6
33-598-06



Biopsy and Aspirating Curettes

Biopsie- und Absaugküretten
Curetas para biopsia y de aspiración

Curettes pour biopsie et d'aspiration
Curette per biopsia et per aspirazione

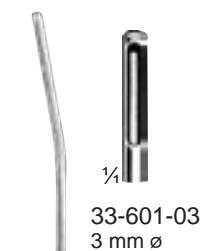

1/4

33-601-03
3 mm ø



33-601-04
4.5 mm ø



1/2

Aspirating
33-601-03 - 33-601-14
29 cm / 11 1/2"



1/2



33-601-06
6 mm ø



33-601-08
8 mm ø



33-601-10
10 mm ø



33-601-12
12 mm ø

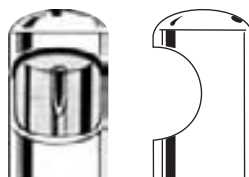

33-601-14
14 mm ø



1/2

For vacuum Biopsy
Suction Curettes, metal,
working ends slightly curved,
graduated.



Bierer
33-604-08 - 33-604-18
(Intra-Uterine)



33-604-08
8 mm ø

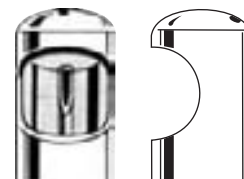

33-604-14
14 mm ø



33-604-10
10 mm ø



33-604-18
18 mm ø



33-604-12
12 mm ø



Uterine Cannulas

Uterus Kanülen
Uterinas de aspiración

Utérines d' aspiration
Uterine d' aspirazione

Intra-Uterine Cannulas



Spackman
33-609-35
35 cm / 14"



Speckman
33-611-35
35 cm / 14"
(Rubber Cone)



Provis
33-614-28
28 cm / 11"



Hayes-Provis
33-617-27
27 cm / 10¾"



Uterine Cannulas

Uterus Kanülen
Uterinas de aspiración

Utérines d' aspiration
Uterine d' aspirazione



Currie
33-621-35
35 cm / 14"



Leech-Wilkinson
33-623-26 - 33-625-26
26.5 cm / 10½"



33-623-26 small
ø 10 x 25 mm 33-624-26 Medium
ø 13 x 30 mm



33-625-26 Large
ø 16 x 30 mm



Behrman
33-627-30
30.5 cm / 12"

Metal Catheters

Metall-Katheter
Sondas metálicas

Sondes métalliques
Sonde metalliche



Bozemann-Fritsch
35 cm / 14"

mm ø	
8	33-631-08
10	33-631-10
12	33-631-12



Drew-Smythe
33-634-35
35 cm / 14"

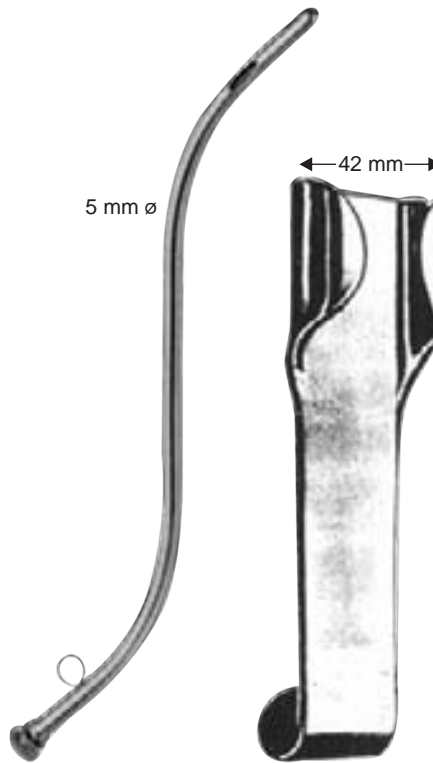

Rotunda
33-637-20
20 cm / 8"

(Pessary Introducer)
33-639-15
15 cm / 6"



Amann
33-641-32
uterine gauze
packer
32 cm / 12 3/4"

Instruments for Removal of I.U.D.

Instrumente für die Entfernung von Spiralen
Instrumentos para remover dispositivo intrauterino

Instruments pour retirer le stérilet
Strumenti per la rimozione dello I.U.D.

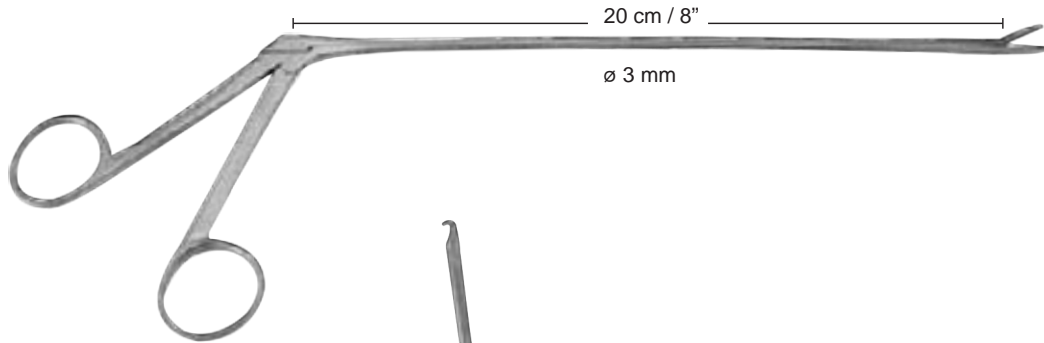
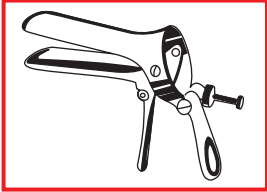

33-646-20

Tubal Hooks for Mini-Lap



33-647-27
Uterine secretion scoop
27 cm / 10¾"



Asch
33-649-20
Uterine secretion scoop
20 cm / 8"



Saunders
33-652-31
I.U.D. Removing hook
31 cm / 12½"



Ramathibodi
33-654-24
24 cm / 9½"



Covault
33-656-22
22 cm / 8¾"



Snook
33-658-20
20 cm / 8"

Falcon[®]

Surgical
Instruments



34

OBSTETRICS

GEBURTSHILFE
OBSTETRICIA
OBSTÉTRIQUE
OSTETRICIA

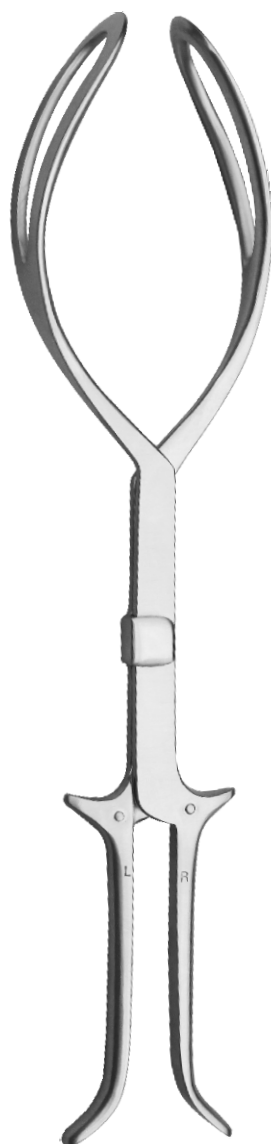

Pelvimeter, Obstetrical Forceps

Beckenzirkel, Geburtszangen
Pelvímetro, Forceps obstétricos

Pelvimètre, Forceps obstétriques
Pelvimetri, Forcipi obstetrici



Martin
34-001-34
34 cm / 13½"
cm/inch scale



Collyer
34-003-30
30 cm / 12"
cm/inch scale



Collin
34-005-35
35 cm / 13¾"
cm scale



Breisky
34-007-33
33 cm / 13"
cm/inch scale



De Lee
34-009-20
20 cm / 8"
cm/inch scale



Naegele
34-011-36 = 36 cm / 14"
34-011-40 = 40 cm / 16"



Simpson
34-013-30
30 cm / 12"

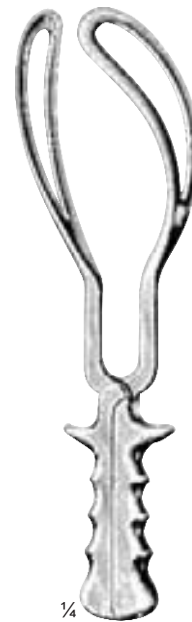

Simpson-Braun
34-015-36
36 cm / 14"



Simpson-Luikart
34-017-36
36 cm / 14"



Obstetrical Forceps

Geburtszangen
Forceps obstétricos

Forceps obstétriques
Forcipi obstetrici



De Lee
34-023-30
30 cm / 12"



De Lee
34-025-36 = 36 cm / 14"
34-025-39 = 39 cm / 15½"



Elliot
34-027-32 = 32 cm / 12½"
34-027-38 = 38 cm / 15"



Mc Lean
34-029-36
36 cm / 14"



Kielland
34-031-41
41 cm / 16"



Kielland-Luikart
34-033-40
40 cm / 15¾"

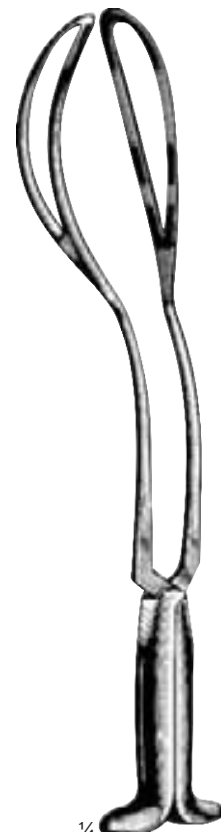

Piper
34-035-44
44 cm / 17¼"



Obstetrical Forceps

Geburtszangen
Forceps obstétricos

Forceps obstétriques
Forcipi obstetrici



¼

Hirst
34-041-26
26 cm / 10¼"



Simpson
34-044-23
23 cm / 9"



Wrigley
34-046-28
28 cm / 11"



¼

Murless
34-049-26
26 cm / 10¼"



¼

MC Lean-Luikart
34-051-39
39 cm / 15½"



Boerma
34-054-28
28 cm / 11"

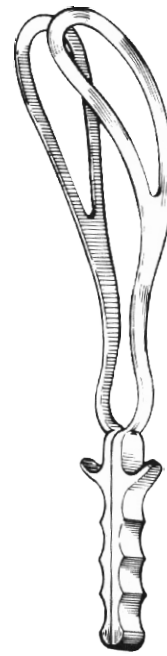

Anderson
34-057-38
38 cm / 15"



Obstetrical Forceps

Geburtszangen
Forceps obstétricos

Forceps obstétriques
Forcipi obstetrici



with traction handle

¼

Dewey
34-061-37
37 cm / 14½"

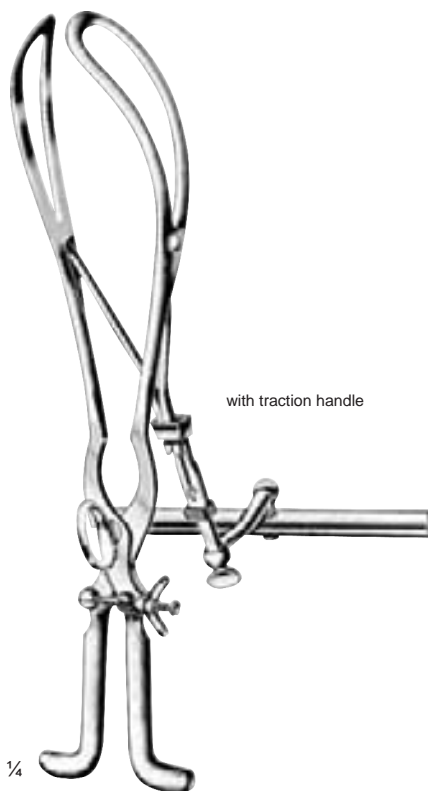

with traction handle

¼

Tarnier
34-063-40
40 cm / 15¾"



with traction handle

¼

Piper
34-065-40
40 cm / 15¾"



¼

Barton
34-067-36
36 cm / 14"

Traction Handle for
obstetrical forceps
34-067-36



¼

Barton
34-069-17
17 cm / 6¾"

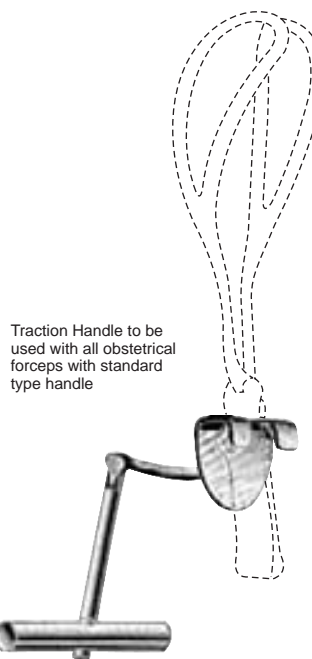

Traction Handle to be
used with all obstetrical
forceps with standard
type handle



Bill
34-071-20

Traction Handle for
obstetrical forceps



¼

Luikart-Bill
34-073-21
21 cm / 8¼"



Obstetrical Forceps

Geburtszangen
 Forceps obstétricos

Forceps obstétriques
 Forcipi obstetrici

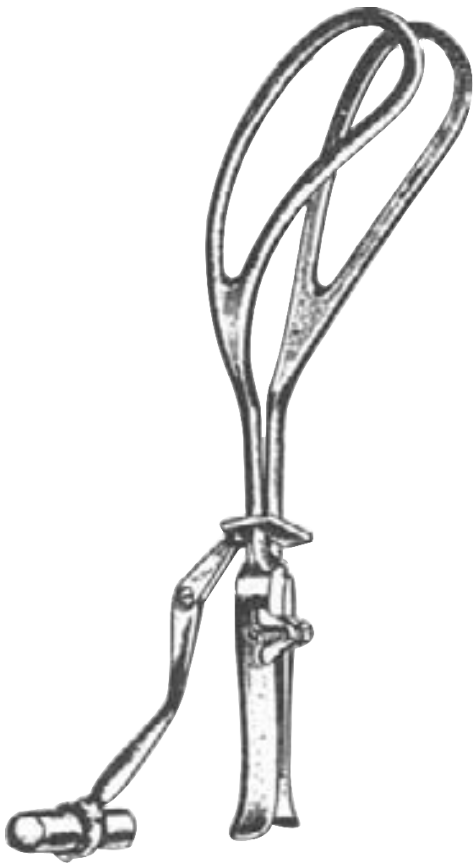

Haig-Fergusson
 34-078-40
 40 cm / 15¾"

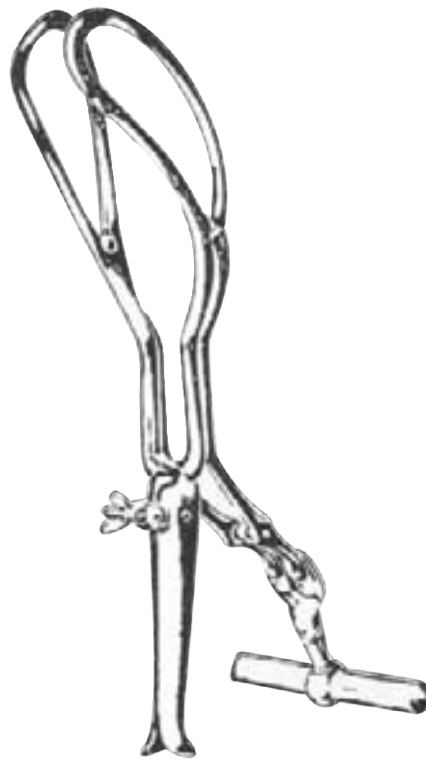

Milne-Murray
 34-081-38
 38 cm / 15"



Barnes-Neville
 34-083-43
 43.5 cm / 17"
 with traction handle

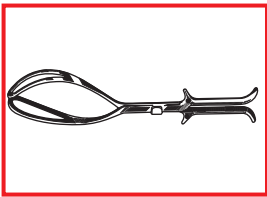

Placenta and Ovum Forceps

Abortuszangen
Pinzas para aborto

Pinces placentaires et pour poste-abortum
Pinze per placenta e per ovaie



Sellheim
34-091-28
28 cm / 11"

1/3



Green-Armytage
34-094-19
19.5 cm / 7 3/4"

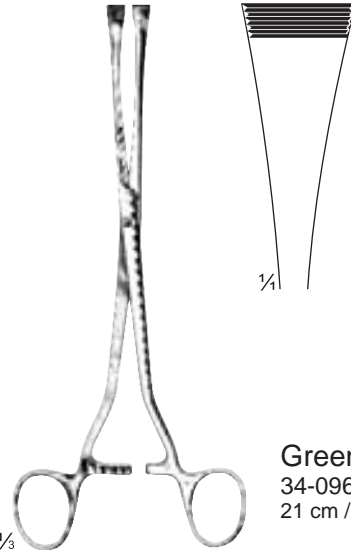

1/4

Green-Armytage
34-096-21
21 cm / 8 1/4"

1/3

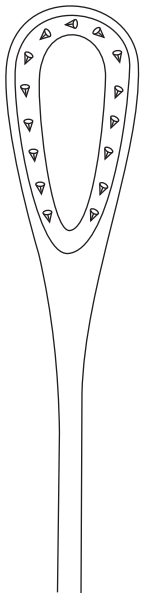

34-098-27

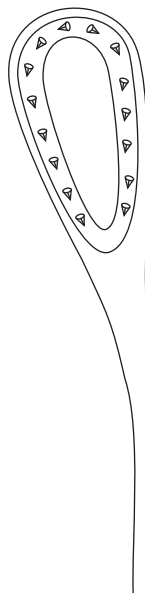

34-099-27

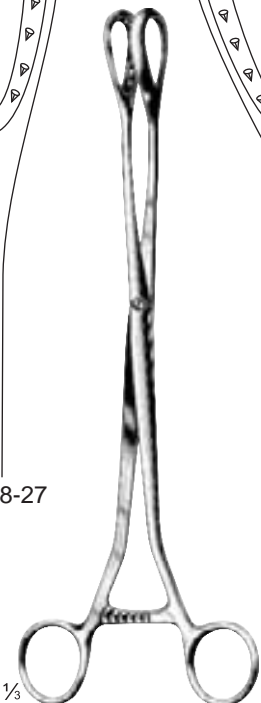

1/3

Saenger
34-098-27 - 34-099-27
27 cm / 10 1/2"



34-102-01
Straight



34-103-01
Curved



1/3

Winter
34-102-01 - 34-103-02
28 cm / 11"

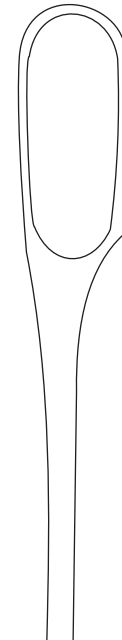

34-102-02
Straight

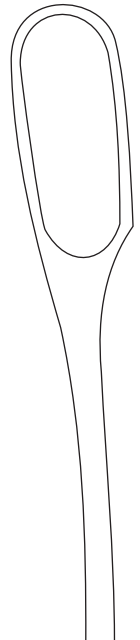

34-103-02
Curved



Placenta and Ovum Forceps

Abortuszangen
Pinzas para aborto

Pinces placentaires et pour poste-abortum
Pinze per placenta e per ovaie

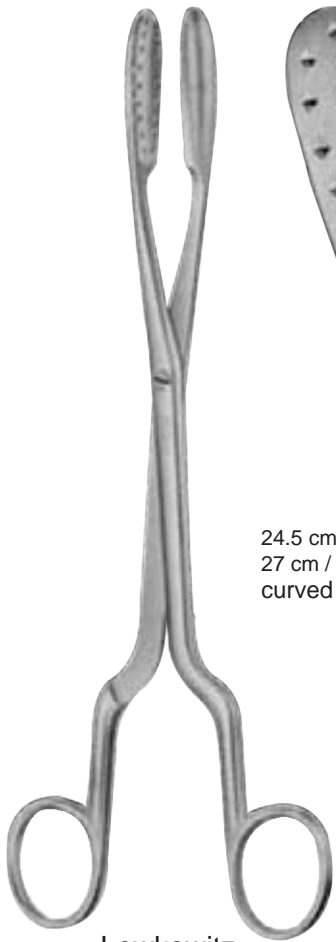

Lewkowitz
24.5 cm / 9¾" 34-108-24
27 cm / 10½" 34-108-27



24.5 cm / 9¾" 34-108-24
27 cm / 10½" 34-108-27
curved



MC Clintock
34-111-24
24 cm / 9½"

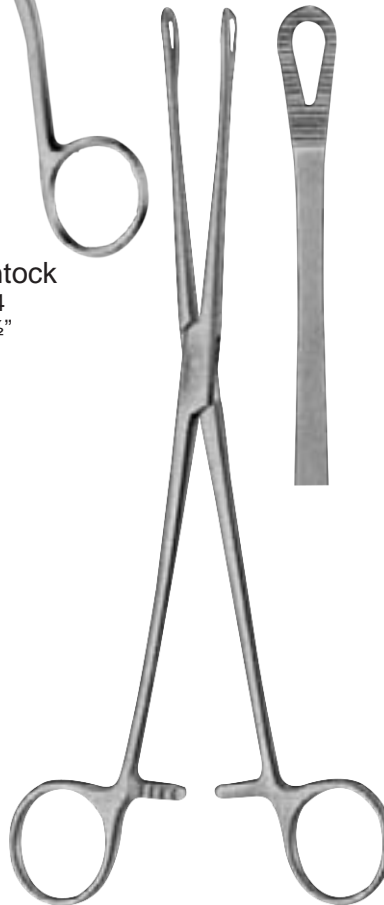

Bonney
34-114-24
24 cm / 9½"



Bumm
34-116-28
28 cm / 11"



Placenta and Ovum Forceps

Abortuszangen
Pinzas para aborto

Pinces placentaires et pour poste-abortum
Pinze per placenta e per ovaie



$\frac{1}{3}$
Corey (Greenhalg)
34-121-24
24 cm / 9½"

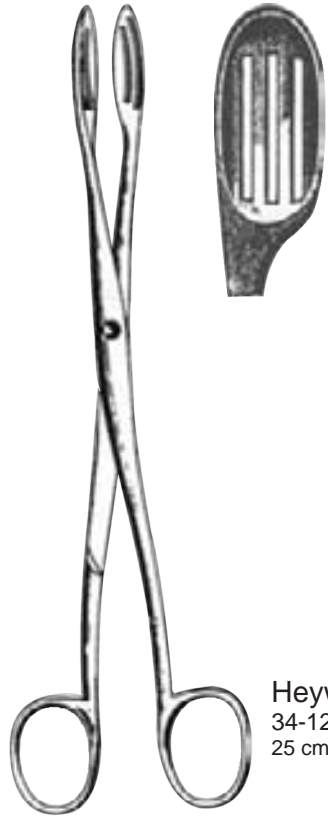

Heywood Smith
34-124-25
25 cm / 10"

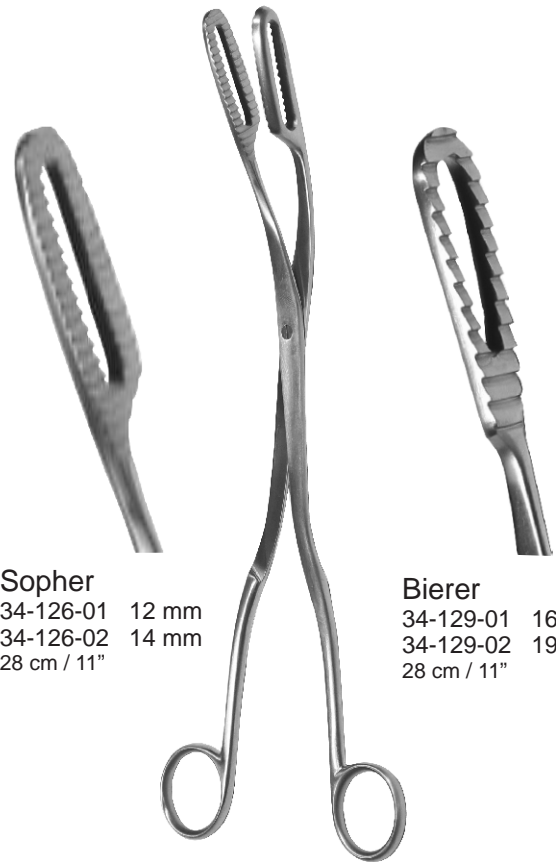

Sopher
34-126-01 12 mm
34-126-02 14 mm
28 cm / 11"

Bierer
34-129-01 16 mm
34-129-02 19 mm
28 cm / 11"

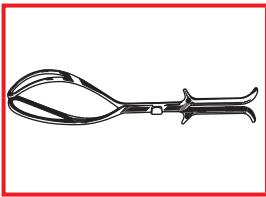

Uterine Forceps, Vaginal Clamp

Uterus-Klemmen, Vaginalklemme
Pinza uterinoś, Pinza vaginal

Pince utérinś, Pince vaginale
Pinze uterini, Pinza vaginale

Uterine Controlling Forceps



Positioned for insertion



(Opens 5cm to the shape of Uterine cavity)

Hulks
(Spring action)
34-135-00

Myomectomy & Vaginal Clamps



Bonney
(Myomectomy)
34-138-27
27 cm / 10½"



Bonney
(Vaginal)
34-141-34
34.5 cm / 13½"



Placenta Scoops

Abortuslöffel
Cucharillas para aborto

Curettes a avortement et placenta
Cucchiai per placenta e ovaie

14 ½ mm



34-148-01
blunt

18 mm



34-148-02
blunt

21 mm



34-148-03
blunt



toothed back

¼

34-150-02
blunt

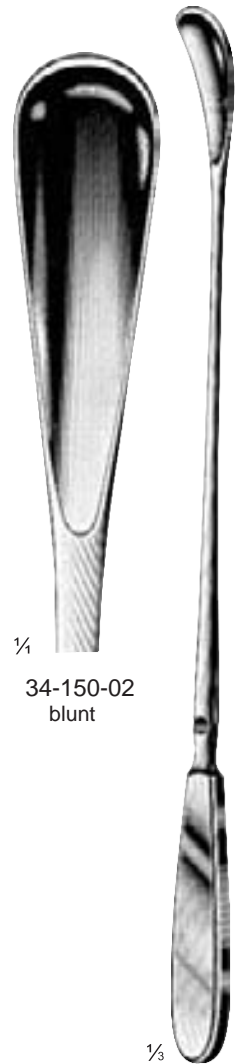

⅓

Wallich
42 cm / 16½"

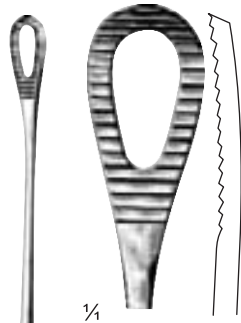

¼

⅓

Pestalozza
34-146-30
30 cm / 12"



Cuzzi
34-148-01 - 34-148-03
30 cm / 12"

Perforators, Umbilical Cord Clamps

Perforatorien, Nabelschnurklemmen
 Perfora-crâneos, Clamps umbilicales

Perce-crânes, Clamps ombilicaux
 Spezzacrani, Clamps ombelicali



1/3

Smellie
 34-154-25
 25 cm / 10"

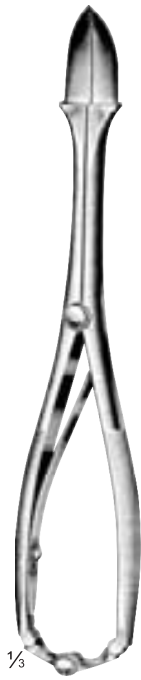

1/3

Naegele
 34-156-25
 25 cm / 10"



1/2

Kane
 34-159-08
 8.5 cm / 3 1/2"



1/2

Collin
 34-161-09
 9 cm / 3 1/2"



Umbilical Dilator
 34-164-09
 9.5 cm / 3 3/4"



1/2

Carton
 34-167-30
 30 cm / 12"
 5 mm ø



Decapitating Hooks, Basiotribe, Cranioclast

Dekapitationshaken, Basiotrib, Kranioklast
 Ganchos para decapitación, Basiotribo, Craneoclasto

Crochets pour détroncation, Basiotribe, Cranioclaste
 Uncino per detroncazione, Basiotribo, Cranioclaste



Smellie
 34-173-30
 30 cm / 12"



Braun
 34-175-30
 30 cm / 12"
 Decapitating Hook



Braun
 34-177-42
 42 cm / 16½"
 Cranioclast

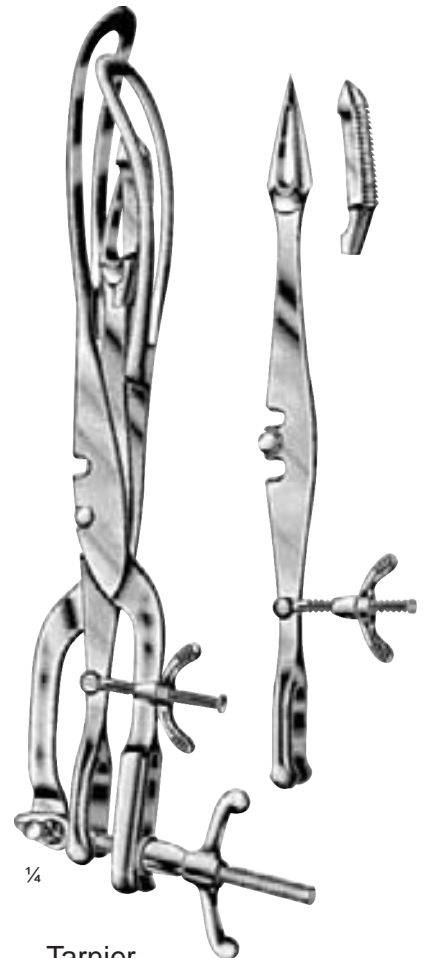

Tarnier
 34-179-46
 46 cm / 18"
 Basiotribe