

Falcon[®]

Surgical
Instruments



29

TRACHEOTOMY

TRACHEOTOMIE
TRAQUEOTOMÍA
TRACHÉOTOMIE
TRACHEOTOMIA



Trocars, Dilators

Trokare, Dilatoren
Traqueótomos, Diladores

Trachéotomes, Dilateurs
Tracheotomi, Dilatori

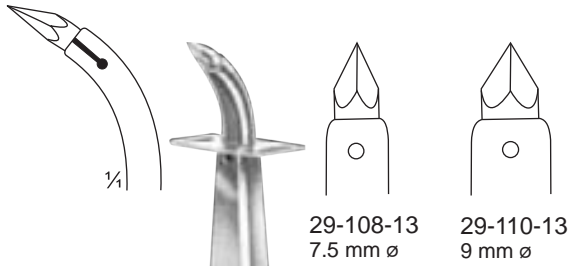
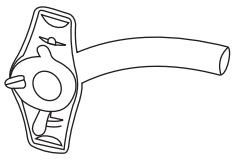

Uckermann
29-108-13 - 29-110-13
13 cm / 5"



Bose
29-112-07
7 cm / 2 3/4"

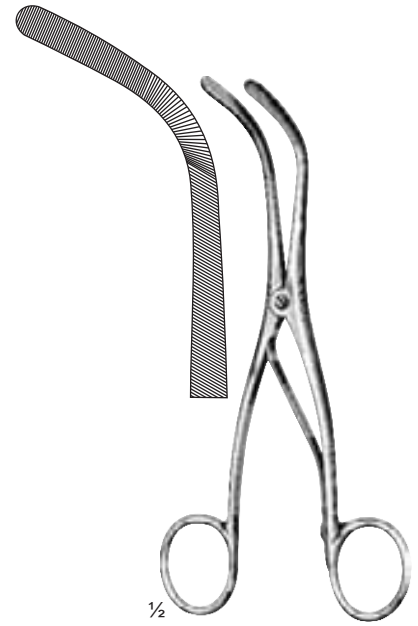

Trousseau
29-114-14
14 cm / 5 1/2"



Bowlby/Laborde
29-115-12 = 12 cm / 4 3/4"
29-115-15 = 15 cm / 6"

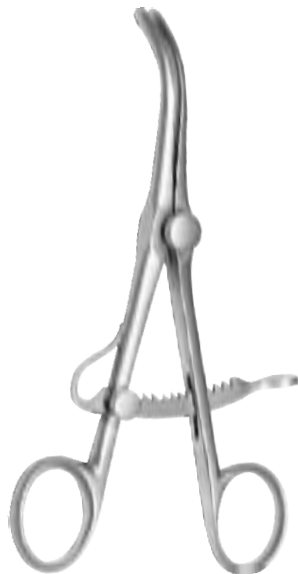

St. Clair Thompson
29-117-14
14 cm / 5 1/2"



Laborde
29-119-14
14 cm / 5 1/2"



Weerda
29-120-19
19 cm / 7 1/2"

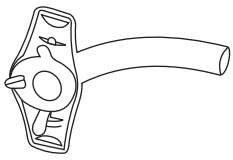

Trachea Retractors

Tracheal-Häkchen
Separadores para la tráquea

Ecarteurs pour trachéotomie
Uncini tracheali



29-125-16



29-129-16

1/2

Iterson

29-125-16 - 29-129-16
16 cm / 6 1/4"



left



1/2

Bose

29-131-16
16 cm / 6 1/4"

sharp



right

1/2

Bose

29-133-16
16 cm / 6 1/4"



1/4



1/2

Rose

29-143-13
13 cm / 5"

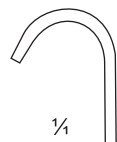

1/4



1/2

Luer

29-145-11
11 cm / 4 1/2"



1/2

Jackson

29-147-15
15 cm / 6"



1/4



1/2

News

29-149-15
15 cm / 6"

1/4

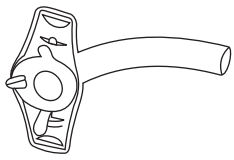

Trachea Retractors

Tracheal-Häkchen
Separadores para la tráquea

Ecarteurs pour trachéotomie
Uncini tracheali



Lukens
29-151-17
17 cm / 6 3/4"



Jakson
29-155-17
17 cm / 6 3/4"



Jakson
29-157-18 - 29-159-18
18 cm / 7"

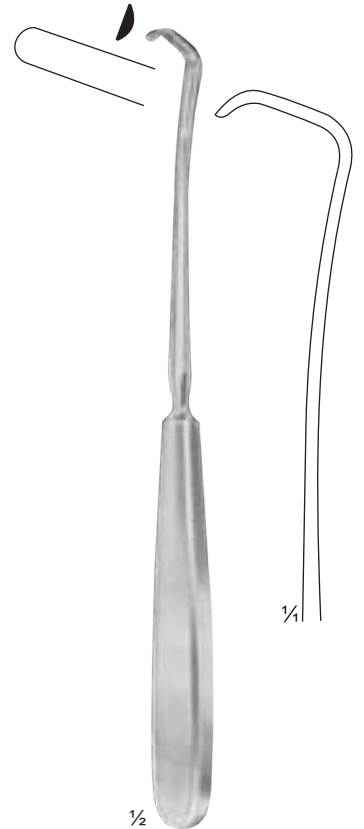

Schoenborn
29-163-21
21 cm / 8 1/4"

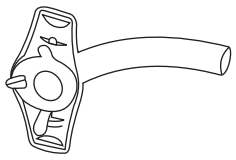

Directors, Seizing Forceps, Muscular Clamp

Sonden, Faßzangen, Muskelklemme
Sondas, Pinzas para el bocio, Pinza para músculos

Sondes, Pince á goitre, Pincés musculaire
Sonde, Pinze per gozzo, Pinza muscolare

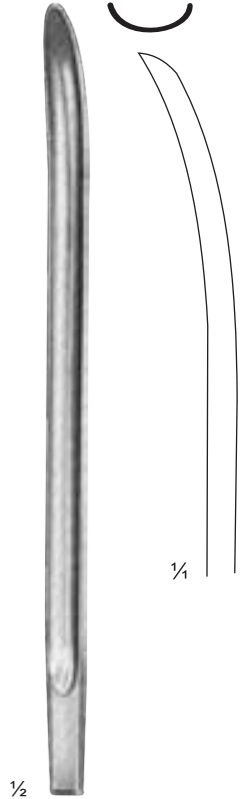

Hofmeister
29-164-21
21 cm / 8¼"

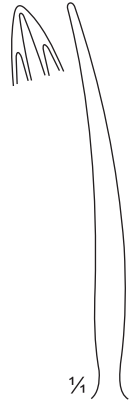

29-165-15
15 cm / 6"

29-165-16
16 cm / 6¼"

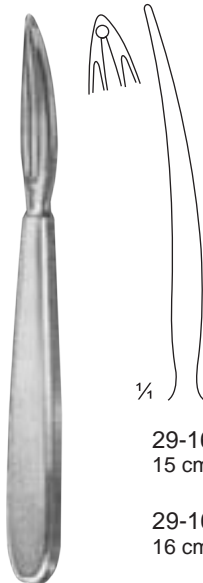

29-166-15
15 cm / 6"

29-166-16
16 cm / 6¼"

Kocher
29-165-15 - 29-166-16

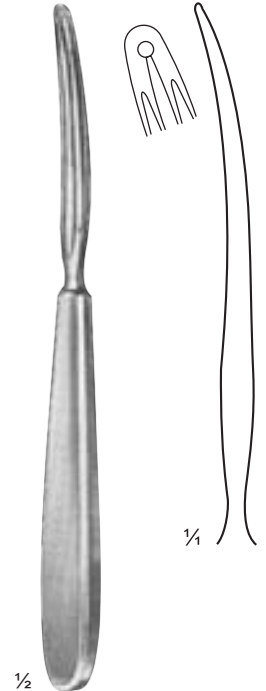

Kocher
29-170-18
18 cm / 7"

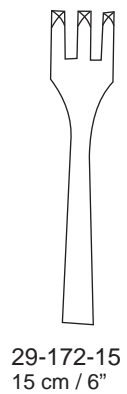

29-172-15
15 cm / 6"

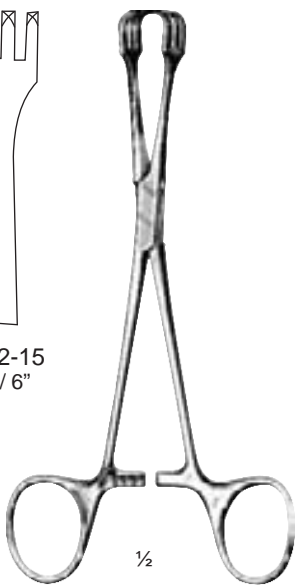

Lahey
29-172-15 - 29-172-20

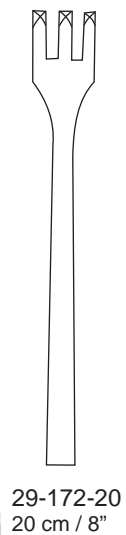

29-172-20
20 cm / 8"

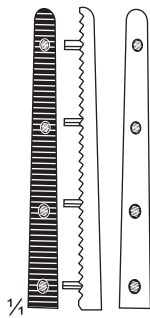

Mastin
29-174-17
17 cm / 6¼"

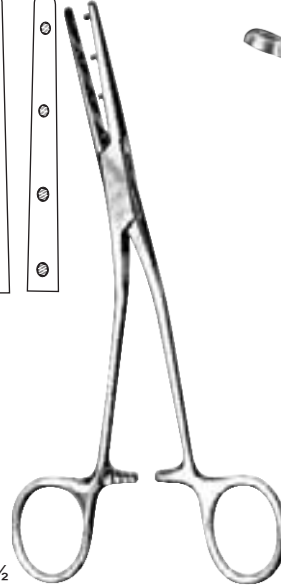

29-176-02

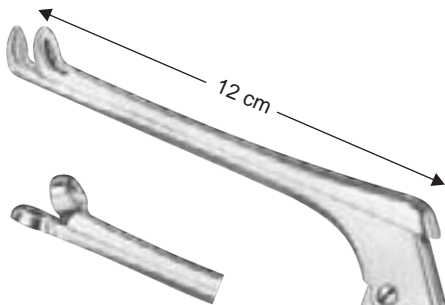

29-176-01



29-176-01 - 29-176-02
20 cm / 8"

Trachea Tubes

Tracheal-Kanülen
Cánulas traqueales

Canules pour trachéotomie
Cannule tracheali

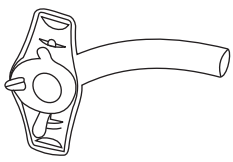

Fig.	0	1	2	3	4	5	6	7	8	9
Charr./Fr.	4	5	6	7	8	9	10	11	12	13
Length	12	15	18	21	24	27	30	33	36	39
Length of outer tube	45	50	55	60	65	70	75	80	85	90



Standard German Silver	Luer	Chevalier-Jackson	Krishaber German silver
Fig. 0	mmø 4	45-90mm 29-180-04	45-90mm 29-182-04
1	5	29-180-05	29-182-05
2	6	29-180-06	29-182-06
3	7	29-180-07	29-182-07
4	8	29-180-08	29-182-08
5	9	29-180-09	29-182-09
6	10	29-180-10	29-182-10
7	11	29-180-11	29-182-11
8	12	29-180-12	29-182-12
9	13	29-180-13	29-182-13

Negus

- 29-186-016 16Fg
 - 29-186-018 18Fg
 - 29-186-020 20Fg
 - 29-186-022 22Fg
 - 29-186-024 24Fg
 - 29-186-026 26Fg
 - 29-186-028 28Fg
 - 29-186-030 30Fg
 - 29-186-032 32Fg
 - 29-186-034 34Fg
 - 29-186-036 36Fg
 - 29-186-038 38Fg
 - 29-186-040 40Fg
- Nickle Silver

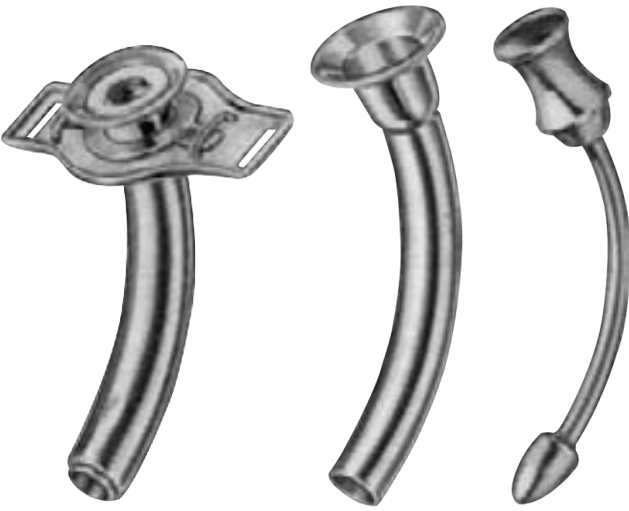

Cubley

- 29-188-016 16Fg
 - 29-188-020 20Fg
 - 29-188-024 24Fg
 - 29-188-028 28Fg
 - 29-188-032 32Fg
- Nicker silver

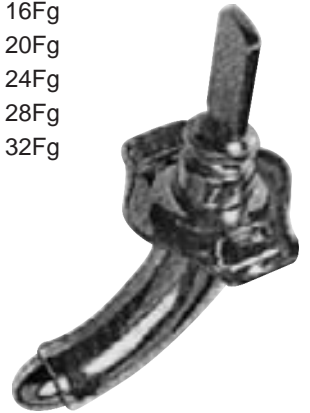

Trachea Tubes

Tracheal-Kanülen
Cánulas traqueales

Canules pour trachéotomie
Cannule tracheali

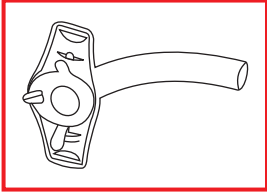

Colledge
Laryngectomy

- 29-192-01 Fig.1 12 mm
 - 29-192-02 Fig.2 14.5 mm
 - 29-192-03 Fig.3 15 mm
 - 29-192-04 Fig.4 15.5 mm
- Nickle



Speaking Tube
Sprechkanüle
Canule parlante
Cánula parlante
Cannula parlante

Fig.	mm	ø	65-90mm
4	8	_____	29-194-08
5	9	_____	29-194-09
6	10	_____	29-194-10
7	11	_____	29-194-11
8	12	_____	29-194-12
9	13	_____	29-194-13

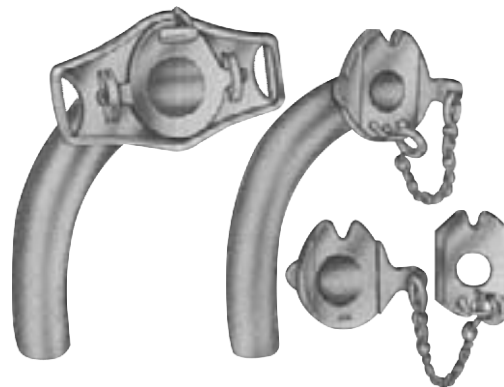

Tracheotomy Set

Tracheotomie-Besteck
Estuche para traqueotomía

Jeu d' instruments pour trachéotomie
Set per tracheotomia

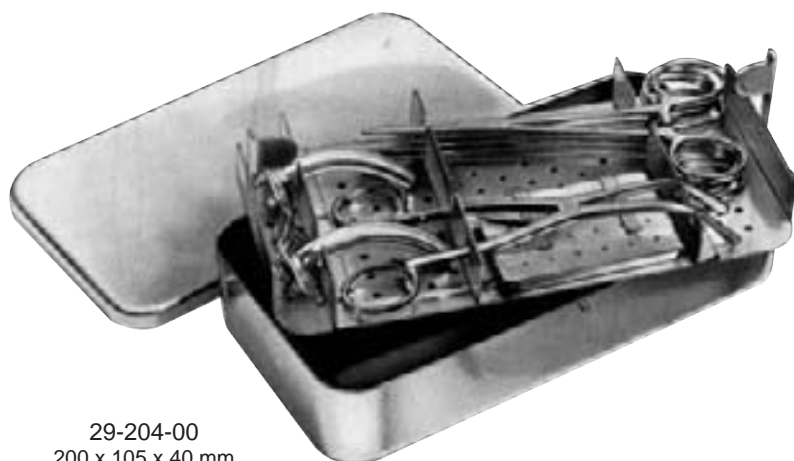
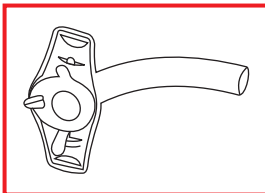

29-204-00
200 x 105 x 40 mm

29-205-00
Tracheotomy Set
complete in ss case 200 x 105 x 40 mm, with
2 Perforated trays of 18/8 containing the
following instruments:

05-044-04 1 Scalpel Handle No. 4 with 1 blade no 23

05-040-10 3 Scalpel Blades, assorted, in perforated
05-040-20 small case

07-002-13 1 Dressing forceps, serrated, 13 cm
07-135-13 2 tissue Forceps, 1 x 2 teeth, 13 cm

08-136-14 4 Crile Artery Forceps, staight, 14 cm
11-024-13 1 Grooved Director, 13cm

29-114-14 1 Trousseau Trachea dilator, 14 cm
29-129-16 2 Iterson Trachea Hooks, blunt
29-131-16 1 Bose Hook, sharp, left hand side, 16cm
29-133-16 1 ditto, right hand side, 16 cm
29-180-04 1 Luer Trachea tube, size 4 mm diam
German Silver

29-180-05 1 ditto, size 4.8 mm diam., German silver

29-212-26 1 Cleaning Brush, 12 mm diam., 26 cm
29-206-00 1 Plastic Pouch for this set

29-206-00
Tracheotomy Set
in case, consisting of:

- 05-044-04 1 Handle with 1 blade, Fig. 20
- 05-044-04 1 Handle with 1 blade, Fig. 23
- 07-002-13 1 thumb forceps 13 cm
- 07-135-13 1 Tissue forceps 13 cm 1 x 2 teeth
- 08-186-13 2 Pean Artery forceps, 13 cm
- 11-024-13 1 Grooved Director, 13 cm
- 29-114-14 1 Trachea Dilator
- 29-129-16 2 Iterson Trachea Retractors, blunt
- 29-131-16 1 Bose Trachea Retractor, sharp,
left hand side
- 29-133-16 1 ditto, right hand side
- 29-180-05 1 Luer Trachea Tube, Standard
- 29-180-06 1 ditto
- 29-212-26 1 Cleaning Brush

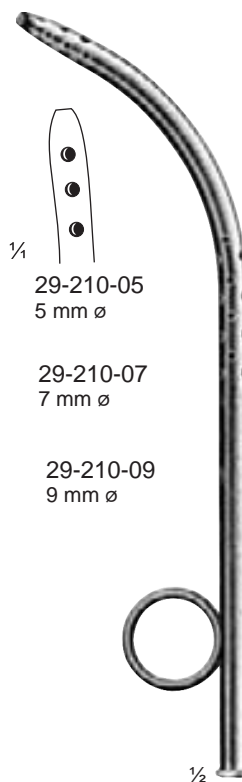

1/4
29-210-05
5 mm ø

29-210-07
7 mm ø

29-210-09
9 mm ø

1/2

Wagner-Mosher
29-210-05 - 29-210-09
20 cm / 8"



29-212-26
26 cm / 10 1/4"
12 mm ø

