

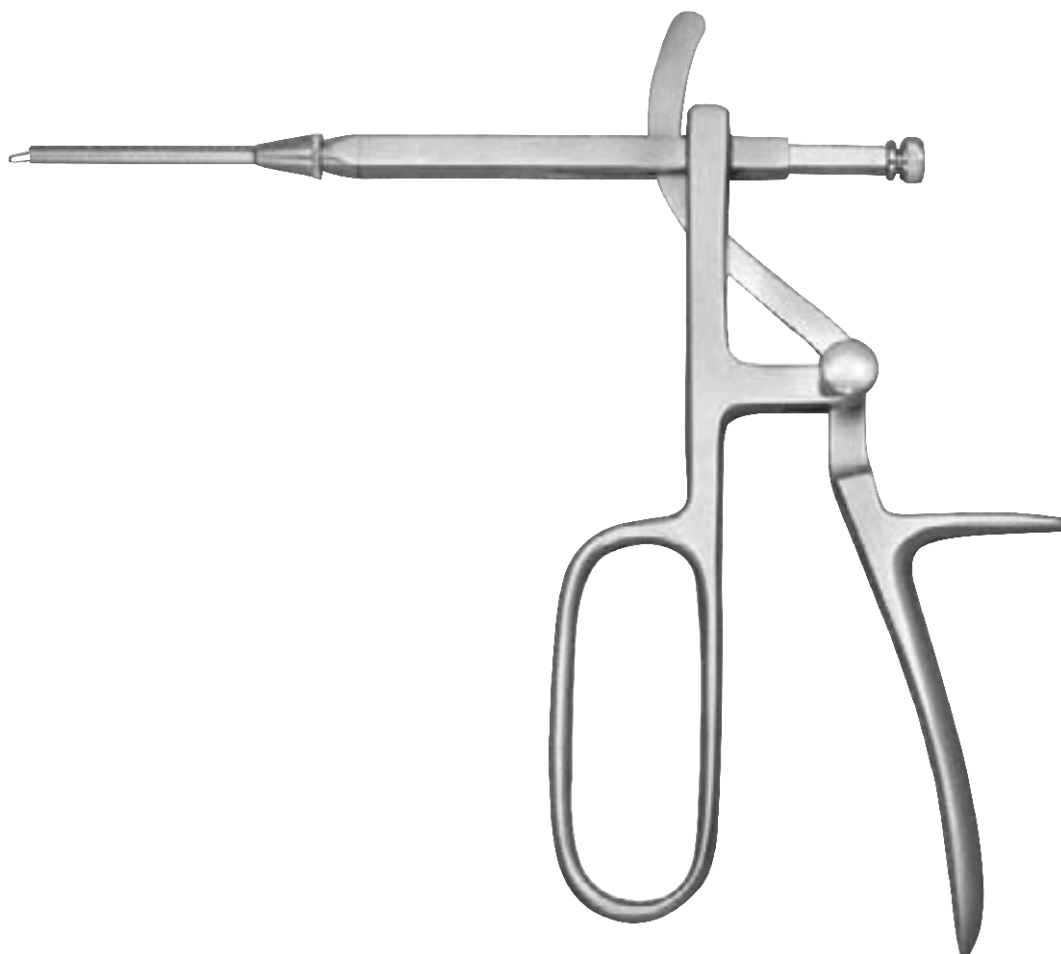

# 42

TONSILLECTOMY, LARYNGO-BRONCHOSCOPY

TONSILLEKTOMIE, LARYNGO-BRONCHOSKOPIE  
TONSILECTOMÍA, LARINGO-BRONCHOSCOPIA  
TONSILLECTOMIE, LARYNGO-BRONCHOSCOPE  
TONSILECTOMIA, LARINGO-BRONCHOSCOPIA





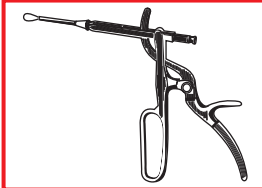

**Gauze Packers**

Tamponstopfer  
Porte-tampon

Taponeadores  
Tamponatori



42-001-02  
17.5 cm / 7"  
2 mm



42-001-03  
17.5 cm / 7"  
3 mm

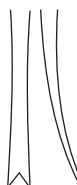
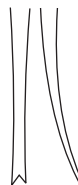

Luniatschek



42-003-17  
17.5 cm / 7"  
2 mm  
round handle



Luniatschek

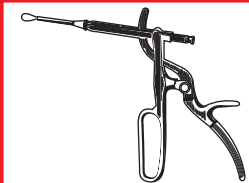

### Cleft Palate Needles

Gaumennadeln  
Agujas para sutura del paladar

Aiguilles pour suturer du palais  
Aghe per sutura del palato

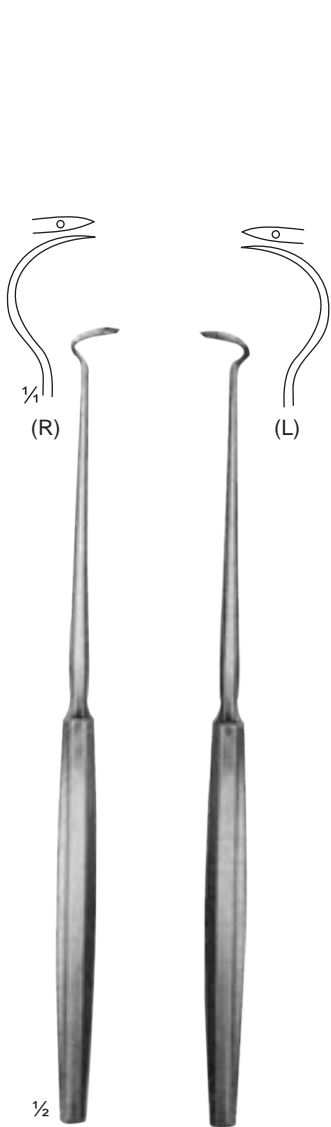

**Hurd**  
42-009-21 - 42-011-21  
20.5 cm / 8"



**Rotter**  
42-013-01 - 42-015-01  
26 cm / 10 1/4"

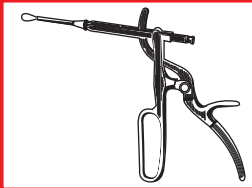

### Cleft Palate Needles

Gaumennadeln  
Agujas para sutura del paladar

Aiguilles pour suturer du palais  
Aghe per sutura del palato



**Nager**  
42-023-24  
24 cm / 9½"

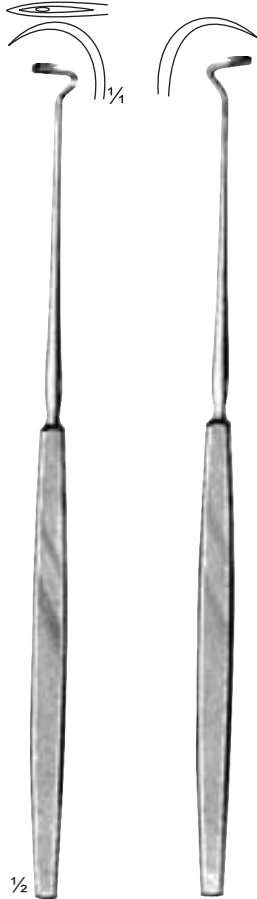

**Dupuy-Weiss**  
42-025-22 - 42-027-22  
22 cm / 8¾"



**Falk**  
42-029-24 - 42-031-24  
24 cm / 9½"

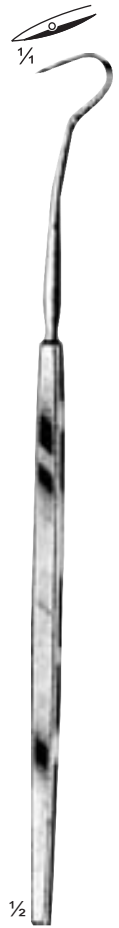

**Claus-Eicken**  
42-033-23  
23 cm / 9"

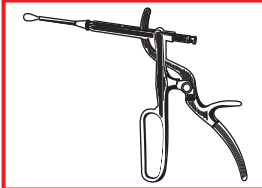

**Tonsil Knives**

Tonsillenmesser  
Bisturías para amígdalas

Bistouris pour amygdales  
Bisturi per tonsille

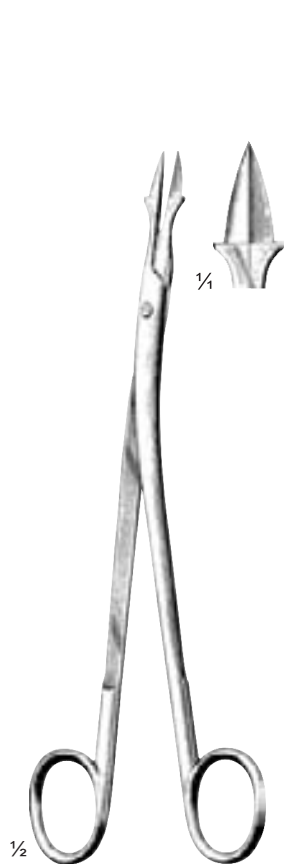

1/2

**Thilenius**  
42-041-19  
19 cm / 7 1/2"



1/2

**Fisher**  
42-043-23  
23 cm / 9"



1/2

**Abraham**  
42-045-21  
21 cm / 8 1/4"



1/2

**Bruenings**  
42-047-23  
23 cm / 9"



**Abraham**  
42-050-19  
19 cm / 7 1/2"



**Canfield**  
42-051-21  
21 cm / 8 1/4"



**Douglas**  
42-053-21  
21 cm / 8 1/4"

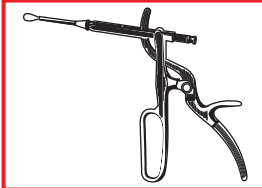

**Tonsil Knives**

Tonsillmesser  
Bisturías para amígdalas

Bistouris pour amygdales  
Bisturi per tonsille



Carpenter  
42-059-25  
25 cm / 9 3/4"



Carpenter  
42-061-24  
24 cm / 9 1/2"



Lopez Reinke  
42-064-23  
23 cm / 9"

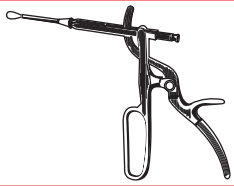

**Dissectors**

Dissektoren  
Disecadores

Dissecteurs  
Dissettori

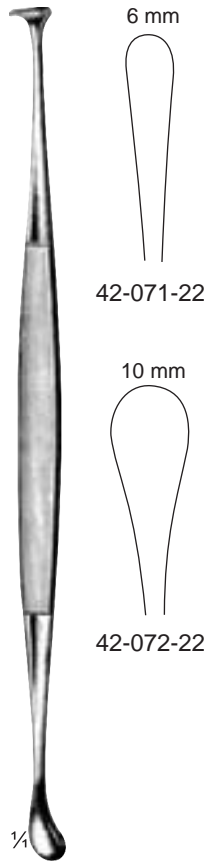

**Hurd**  
42-071-22 - 42-072-22  
22.5 cm / 8¾"

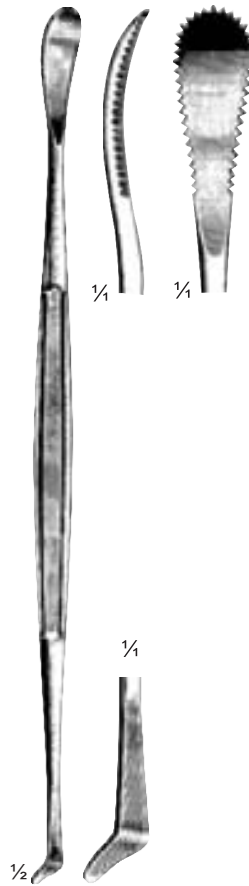

**Henke**  
42-075-23  
22.5 cm / 8¾"

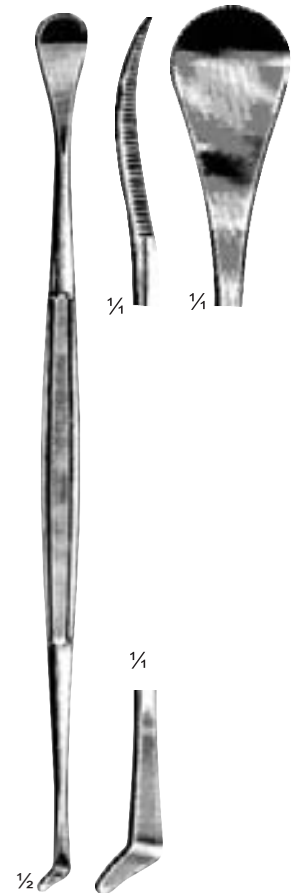

**Henke**  
42-077-23  
22.5 cm / 8¾"



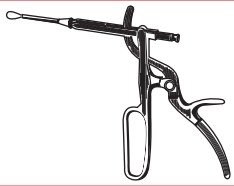

**Dissectors**

Dissektoren  
Disecadores

Dissecteurs  
Dissettori



**Negus**  
42-082-21  
Aspirator  
21 cm / 8¼"



**Wood**  
42-083-20  
(Dissector)  
20 cm / 8"



**Wood**  
42-084-20  
(Piller Retractor)  
20 cm / 8"



**Gwynne Evan**  
42-086-23  
(10 and 12mm)  
23 cm / 9"



**Gwynne Evan**  
42-089-20  
(8 and 6mm)  
20 cm / 8"

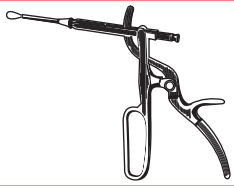

### Dissectors

Dissektoren  
Disecadores

Dissecteurs  
Dissettori



**Beavis**  
42-126-20  
(Pillar Diss)  
20 cm / 8"

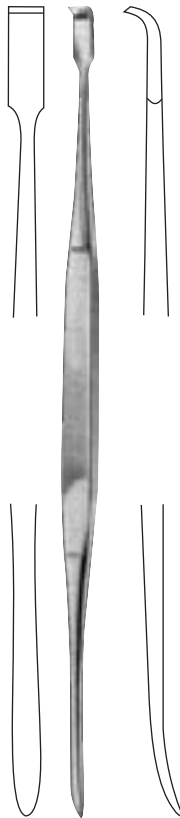

**Howarth**  
42-129-21  
(Diss and  
Rougine)  
21.5 cm / 8½"



**Hill**  
42-132-22  
(Diss and  
Rougine)  
22 cm / 8¾"



**Mollison**  
42-135-21  
(Enucleator)  
21 cm / 8¼"



**Seymour**  
42-138-21  
Jones  
21 cm / 8¼"



**Weider**  
42-141-21  
21 cm / 8¼"

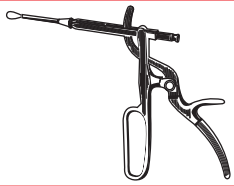

### Tonsil Dissector/Retractor, Tonsil Elevators

Tonsillenelevator/Retraktor, Tonsillenelevatorien  
 Disector/separador para amígdalas, Elevadores para amígdalas

Dissecteur/Rétracteur pour amygdales, Elévateurs pour amygdales  
 Disettori/Retrattori per tonsille, Elevattori per tonsille

42-148-01

Pack of catgut ligatures,  
sterile



**Roder**  
 42-149-00  
 26.5 cm / 10½"



**Love**  
 42-152-15 - 42-156-15  
 15 cm / 6"



**Hofer**  
 42-159-24  
 24 cm / 9½"

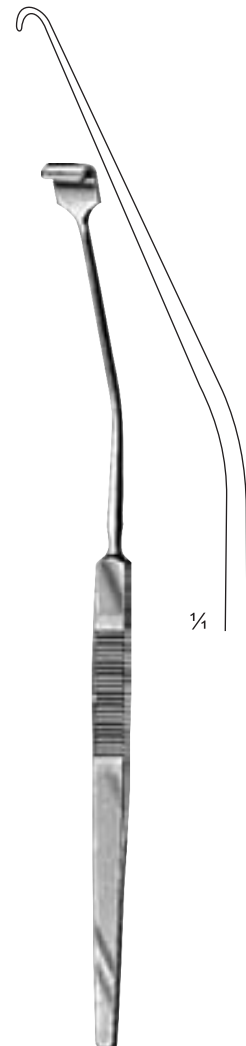

**Nager**  
 42-161-23  
 23 cm / 9"



**Marschik**  
 42-164-22  
 22 cm / 8¾"

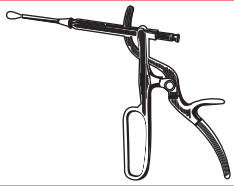

### Tonsil Forceps

Tonsillenzangen  
Pinzas para las amígdalas

Pinces pour amygdales  
Pinze per tonsille



**Blohmke**  
42-171-20  
20 cm / 8"



**Marschik-Krone**  
42-174-20  
20 cm / 8"



**Abraham**  
42-176-20  
20 cm / 8"

**Seizing Forceps, Muscular Clamp**

Faßzangen, Muskelklemme  
Pinzas para el bocio, Pinza para músculos

Pince à goitre, Pince musculaire  
Pinze per gozzo, Pinza muscolare

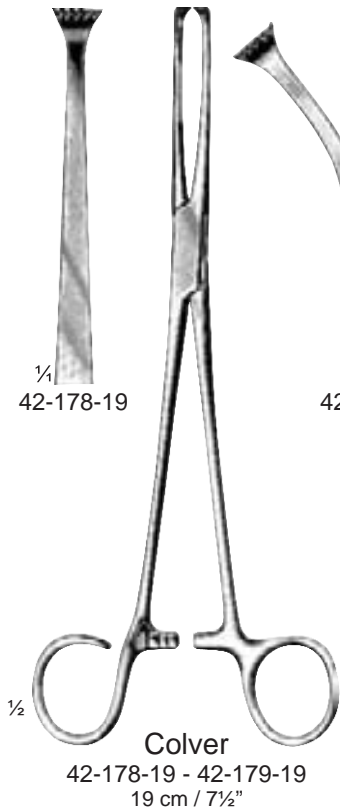
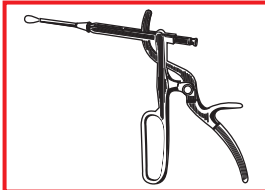

**White**  
42-184-18 = 18 cm / 7"  
42-185-23 = 23 cm / 9"

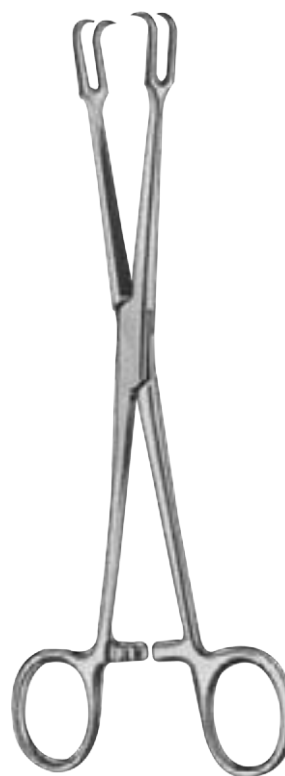

**Museux**  
42-196-20  
20 cm / 8"

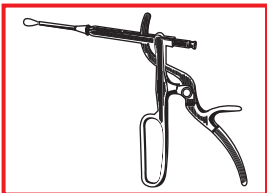

### Tonsil Snares

Tonsillenschnürer  
Cierra-Nudos para amígdalas

Serre-noeuds pour amygdales  
Serranodi per tonsille

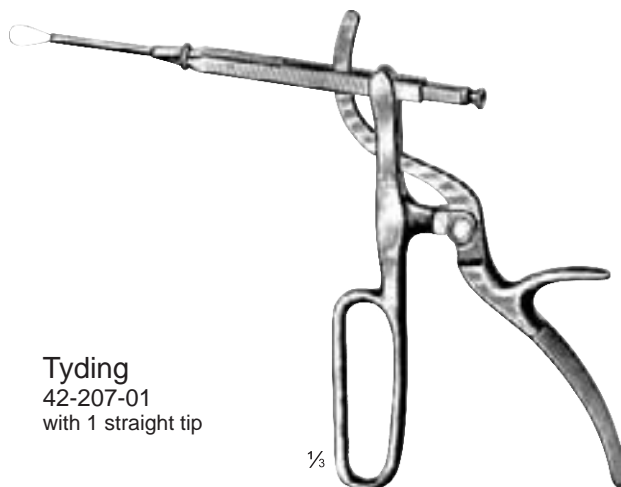

Tyding  
42-207-01  
with 1 straight tip

1/3

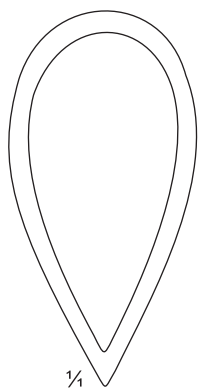
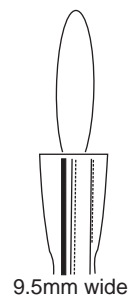

42-209-40 = 40 mm  
42-209-50 = 50 mm  
Pack of 100 pcs.  
wire loop



42-211-01  
0.3 mm ø  
Pack of 12 pcs.  
snare wire



Eves  
42-214-28  
28.5 cm / 11¼"



Eves  
42-216-28  
28.5 cm/11¼"



Bruenings  
42-218-29  
29 cm/11½"

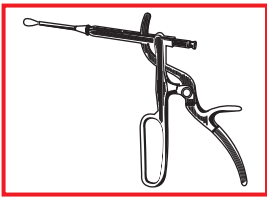

### Tonsillectome

Tonsillotom  
Amigdalótomo

Amygdalotome  
Tonsillotomo

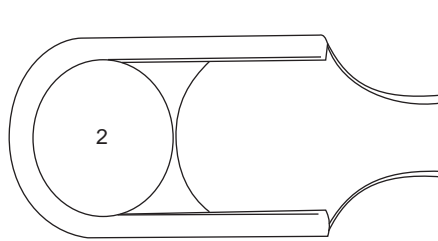

42-225-02  
Fig. 2

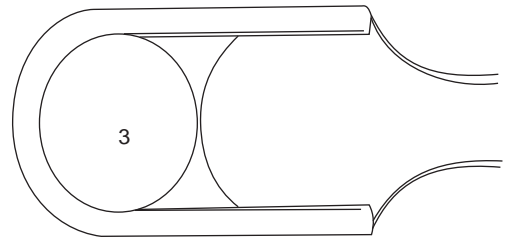

42-225-03  
Fig. 3

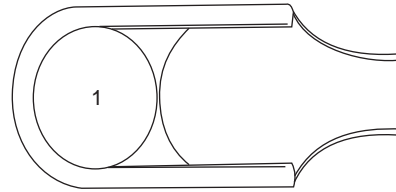

42-225-01  
Fig. 1

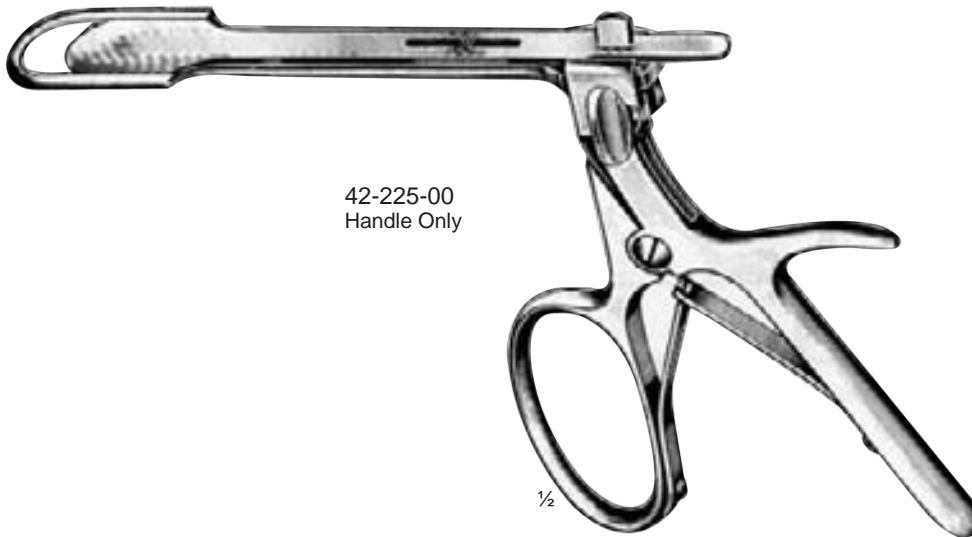

42-225-00  
Handle Only

1/2

Sluder-Ballenger  
42-225-04  
complete with 3 tips

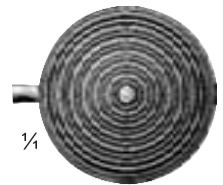

1/4



1/3

Corwin  
42-227-14  
14 cm / 5 1/2"

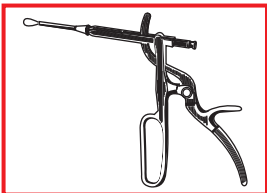

**Tonsil Punches**

Tonsillenzangen  
Pinzas para amígdalas

Pinces pour amygdales  
Pinze per tonsille

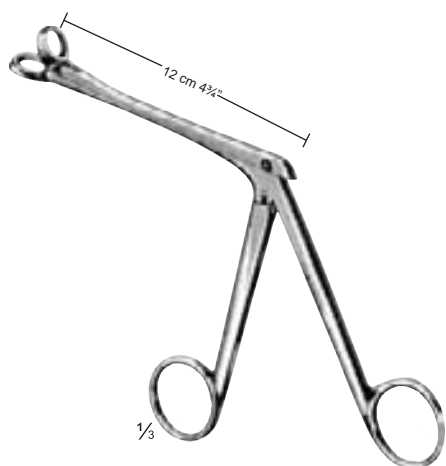

**Hartmann**  
42-235-13 - 42-235-17



42-235-13  
13 mm ø

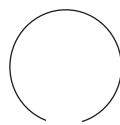

42-235-15  
15 mm ø

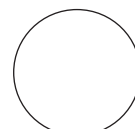

42-235-17  
17 mm ø



42-238-01



42-238-02



42-238-03



**Schmeden**  
42-238-01 - 42-238-03



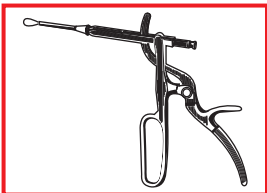

### Laryngeal Forceps

Laryngo-Zangen  
Pinzas para Laringología

Pinces pour Laryngologie  
Pinze per Laringologia

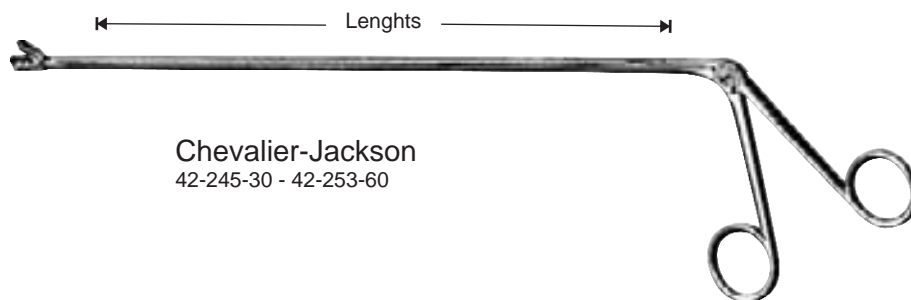

L



30 cm / 12"	42-245-30
40 cm / 16"	42-245-40
50 cm / 20"	42-245-50
60 cm / 24"	42-245-60

42-246-30
42-246-40
42-246-50
42-246-60

42-247-30
42-247-40
42-247-50
42-247-60

42-248-30
42-248-40
42-248-50
42-248-60

L



30 cm / 12"	42-249-30
40 cm / 16"	42-249-40
50 cm / 20"	42-249-50
60 cm / 24"	42-249-60

42-250-30
42-250-40
42-250-50
42-250-60

42-252-30
42-252-40
42-252-50
42-252-60

42-253-30
42-253-40
42-253-50
42-253-60

**Forceps for Laryngo-Bronchoscopy**

Zangen zur Laryngo-Bronchoskopie  
Pinzas para Laringo-Broncoscopía

Pinces pour Laryngo-Bronchoscopie  
Pinze per Laringo-Broncoscopia

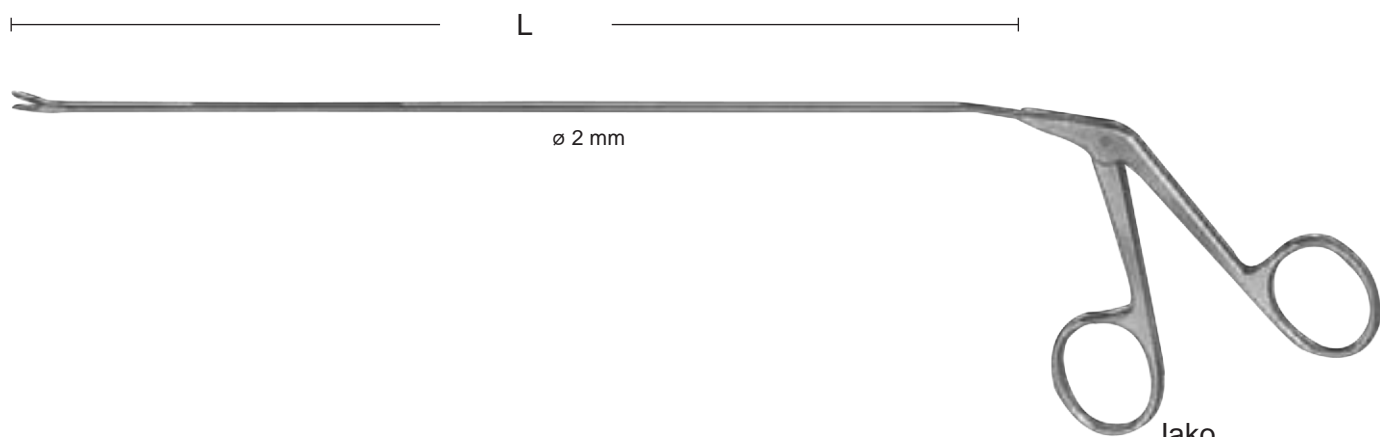
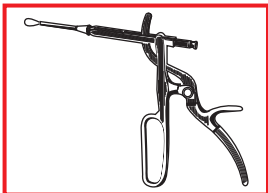

Jako

42-260-30 - 42-263-50



L

30 cm / 12"	42-260-30	42-261-30	42-262-30	42-263-30
35 cm / 16"	42-260-35	42-261-35	42-262-35	42-263-35
40 cm / 16"	42-260-40	42-261-40	42-262-40	42-263-40
45 cm / 18"	42-260-45	42-261-45	42-262-45	42-263-45
50 cm / 20"	42-260-50	42-261-50	42-262-50	42-263-50
55 cm / 22"	42-260-55	42-261-55	42-262-55	42-263-55
60 cm / 24"	42-260-60	42-261-60	42-262-60	42-263-60

**Universal handles and tips**

Universalgriffe und Aufsätze  
Mangos universales y pinzas intercambiables

Manches universels et pinces interchangeables  
Manici universali e pinze intercambiabili

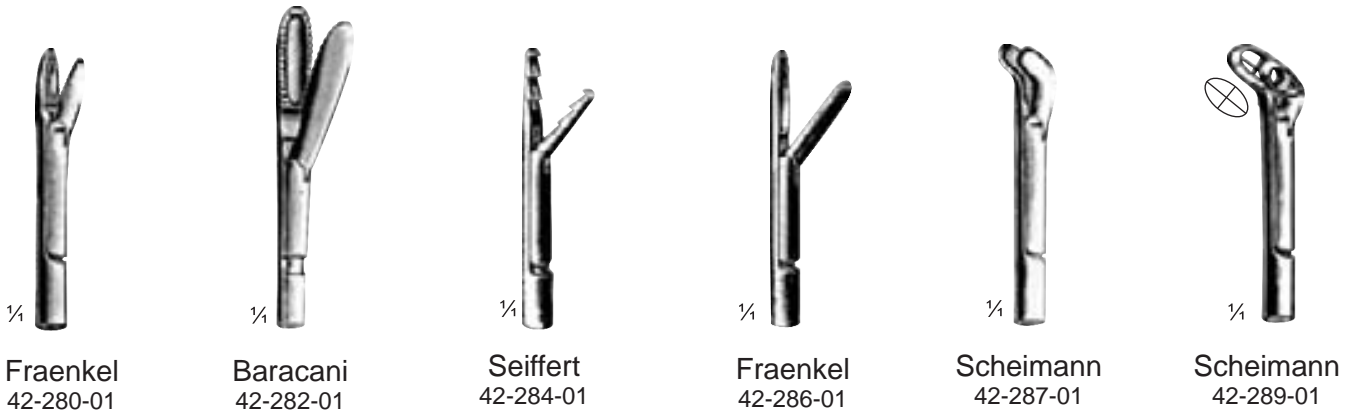
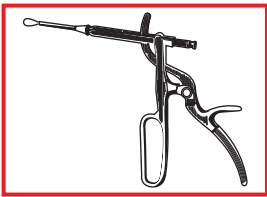

1/2  
42-274-20 - 42-274-60  
Interchangeable tube  
straight  
42-274-20 20cm 8"  
42-274-30 30cm 12"  
42-274-40 40cm 16"  
42-274-50 50cm 20"  
42-274-60 60cm 24"

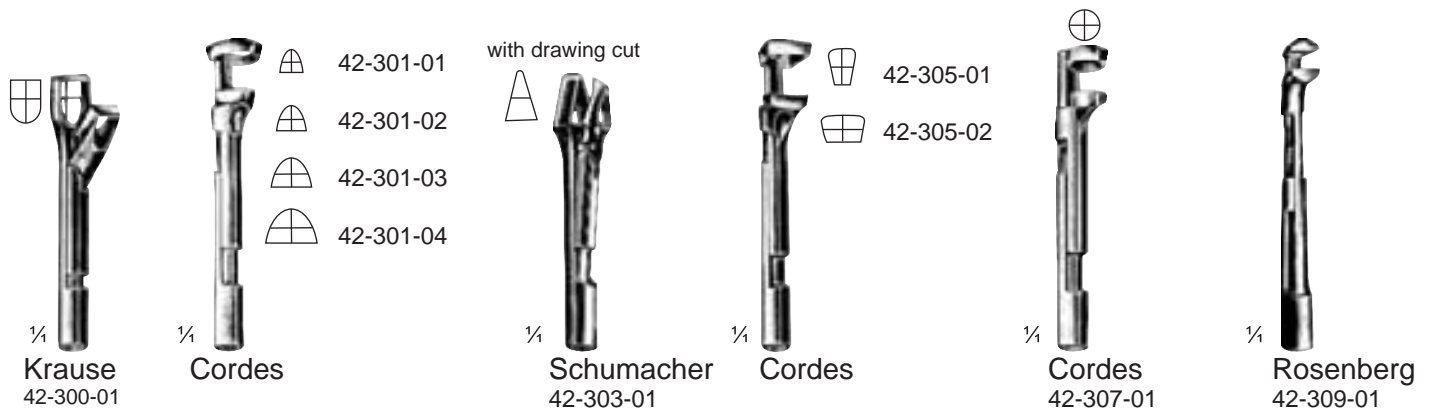
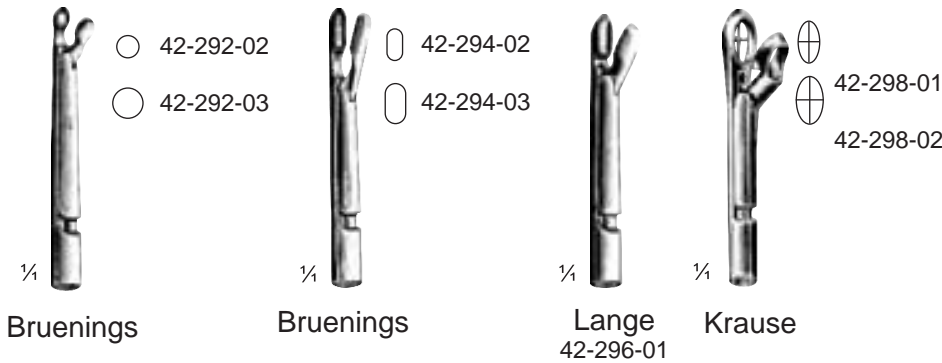
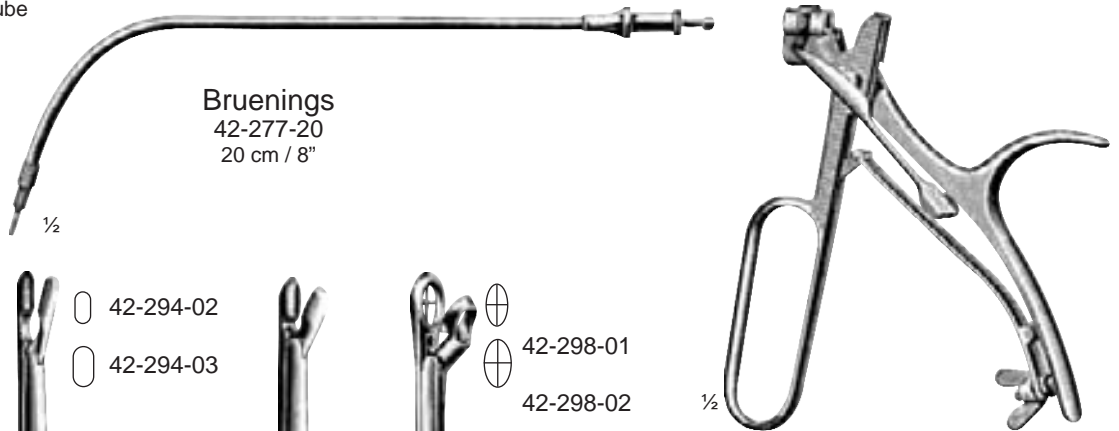

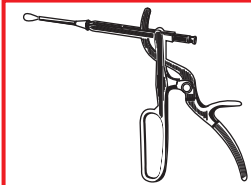

### Laryngeal Mirrors, Laryngeal Mirror Handles

Kehlkopfspiegel, Kehlkopfspiegel-Griffe  
Espejos laringeos, Mangos para espejos laringeos

Miroirs laryngiens, Manche pour miroirs laryngiens  
Specchi laringei, Manico per specchi laringei



½  
42-316-11  
11 cm / 4½"



½  
42-318-10  
10 cm / 4"



½  
42-320-12  
12.5 cm / 5"



½  
42-323-08  
42-323-10  
42-323-12  
42-323-14  
42-323-16  
42-323-18  
42-323-20  
42-323-22  
42-323-24  
42-323-26  
42-323-28  
42-323-30  
18.5 cm / 7¼"

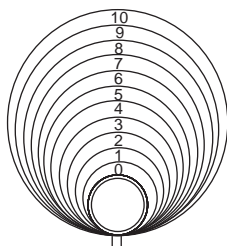

Fig. 00 = 8 mm ø  
Fig. 0 = 10 mm ø  
Fig. 1 = 12 mm ø  
Fig. 2 = 14 mm ø  
Fig. 3 = 16 mm ø  
Fig. 4 = 18 mm ø  
Fig. 5 = 20 mm ø  
Fig. 6 = 22 mm ø  
Fig. 7 = 24 mm ø  
Fig. 8 = 26 mm ø  
Fig. 9 = 28 mm ø  
Fig. 10 = 30 mm ø



½  
42-325-08  
42-325-10  
42-325-12  
42-325-14  
42-325-16  
42-325-18  
42-325-20  
42-325-22  
42-325-24  
42-325-26  
42-325-28  
42-325-30  
13.5 cm / 5¼"



½  
Michel  
42-327-10 - 42-327-18  
25 cm / 10"

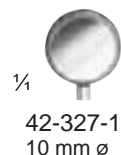

¼  
42-327-10  
10 mm ø

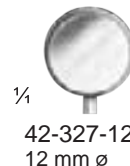

¼  
42-327-12  
12 mm ø



¼  
42-327-14  
14 mm ø



¼  
42-327-16  
16 mm ø



¼  
42-327-18  
18 mm ø

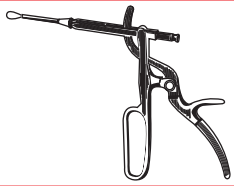

### Laryngeal Polypus Forceps

Kehlkopfpolypenzangen  
Pinzas para pólipos laríngeos

Pinces à polypes laryngiens  
Pinze per polipi laringei

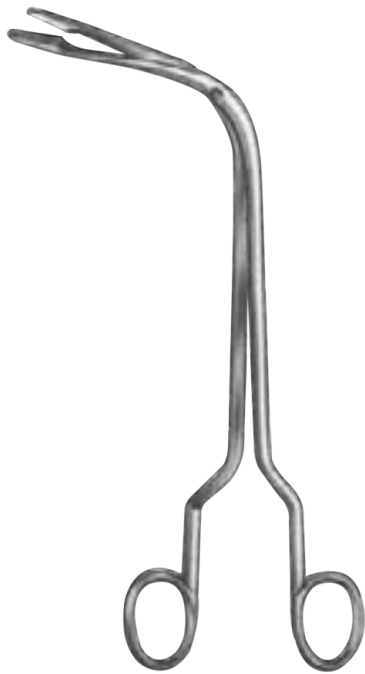

Fraenkel  
42-333-18  
18 cm / 7"

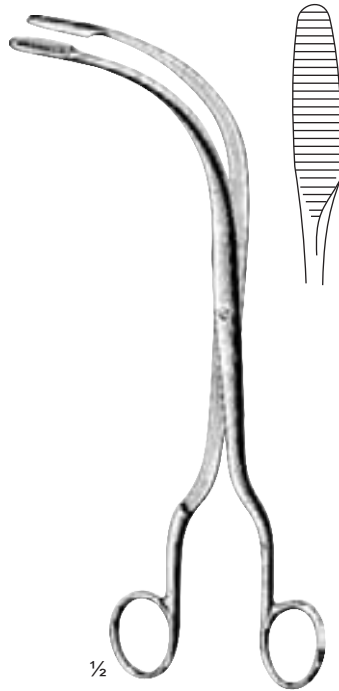

$\frac{1}{2}$   
Fraenkel  
42-335-19  
19 cm / 7½"

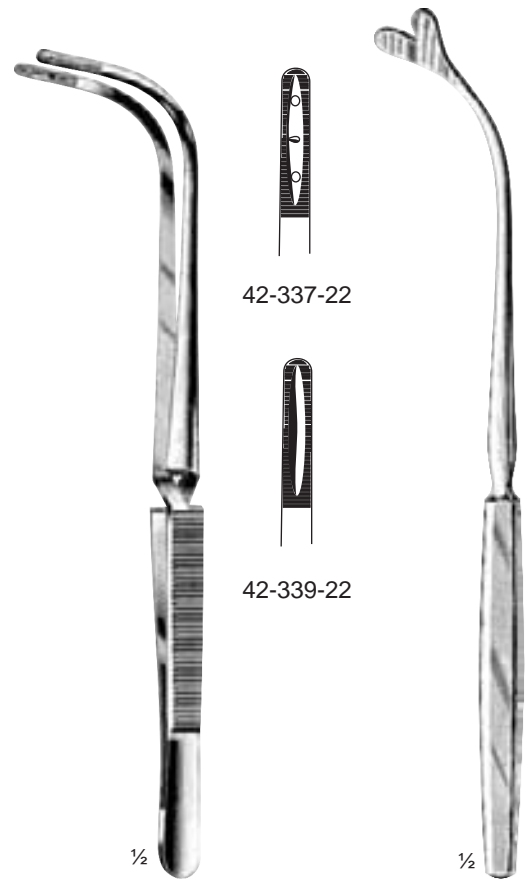

$\frac{1}{2}$   
Jackson  
42-337-22 - 42-339-22  
22 cm / 8¾"

$\frac{1}{2}$   
Reichert  
42-341-24  
24 cm / 9½"

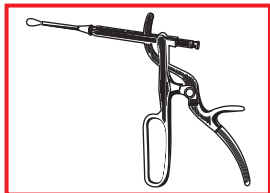

### Laryngeal Polypus Forceps

Kehlkopfpolypenzangen  
Pinzas para pólipos laríngeos

Pinces à polypes laryngiens  
Pinze per polipi laringei

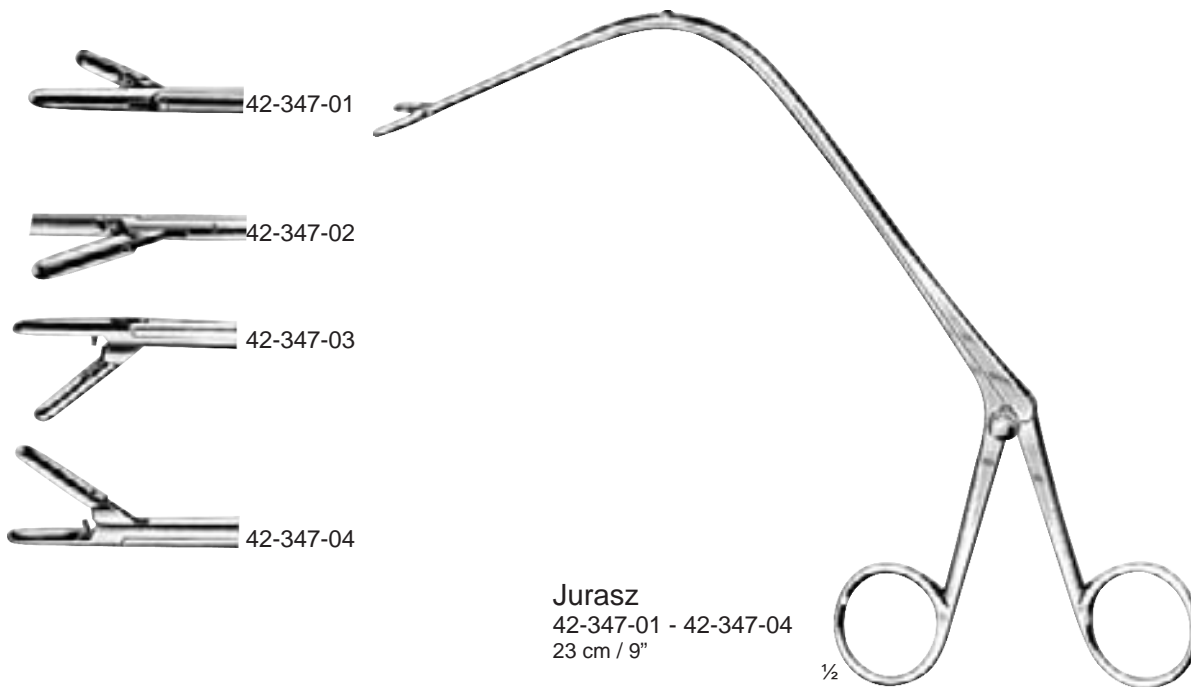

**Jurasz**  
42-347-01 - 42-347-04  
23 cm / 9"

1/2



**Lane**  
42-350-00  
26.5 cm / 10 1/2"



**Fraenkel**  
42-353-00  
26.5 cm / 10 1/2"