

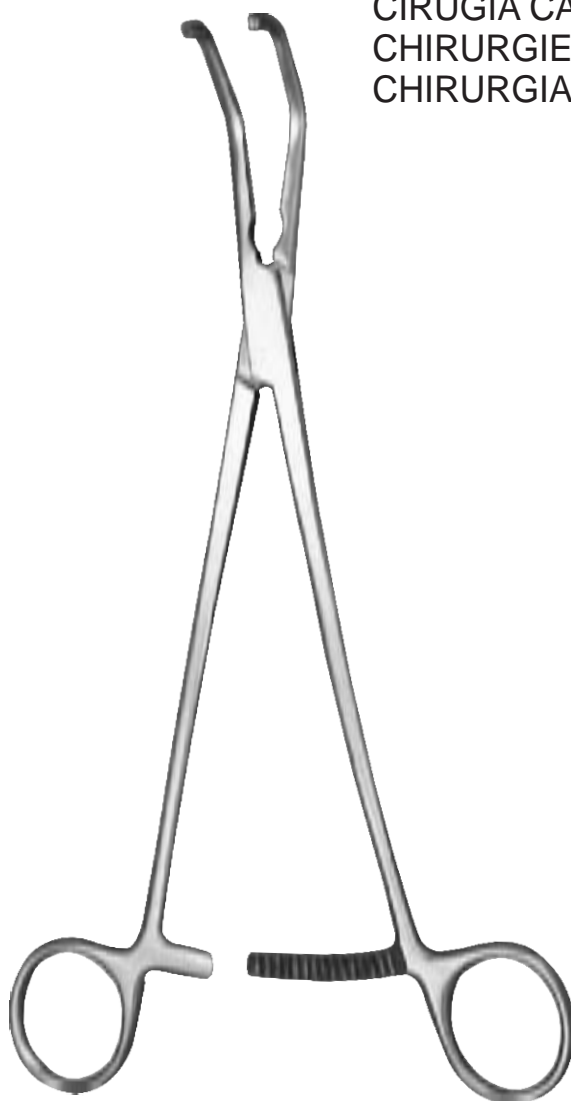

26

CARDIOVASCULAR SURGERY

HERZ- U. GEFÄßCHIRURGIE
CIRUGÍA CARDIOVASCULAR
CHIRURGIE CARDIO-VASCULAIRE
CHIRURGIA CARDIOVASCOLARE





Rib Shears

Rippenscheren
Costótomos

Costotomes
Costotomi



½

26-002-17
17 cm / 6¾"



½

26-003-22
22 cm / 8¾"



½

26-004-23
23 cm / 9"



½

with eccentric
sliding blade

Gluck
26-005-22
22 cm / 8¾"



½

Stille
26-007-21
21 cm / 8¼"

Rib Shears, Sternum Chisel

Rippenscheren, Sternummeißel
Costótomos, Cinceles

Costotomes, Ciseau-burin à sternum
Costotomi, Scalpello per sterno

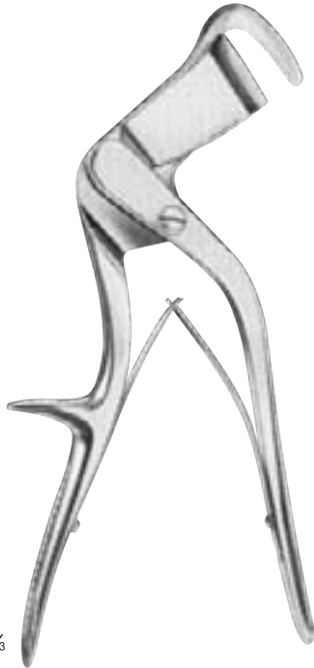
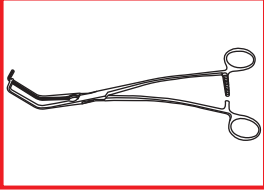

1/3

Lebsche
26-013-25
25 cm / 10"



26-015-32
for the right hand

26-017-32
for the left hand

1/3

Brunner
26-015-32 - 26-017-32
32 cm / 12½"



1/3

Lebsche
26-019-24
24.5 cm / 9¾"



1/3

Sauerbruch
26-021-26
26 cm / 10¼"



1/3

Giertz-Stillé
26-023-27
27 cm / 10½"



1/3

Sauerbruch-Frey
26-025-36
36 cm / 14"

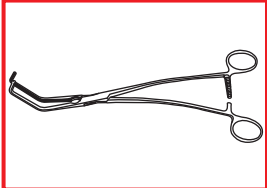

Rib Shears

Rippenscheren

Costotomes

Costótomos

Costotomi



Collin
26-032-20
20 cm / 8"



Bethune
26-034-34
34 cm / 13½"



26-038-35
Right

Coryllos-Bethune
26-037-35
35 cm / 13¾"
left

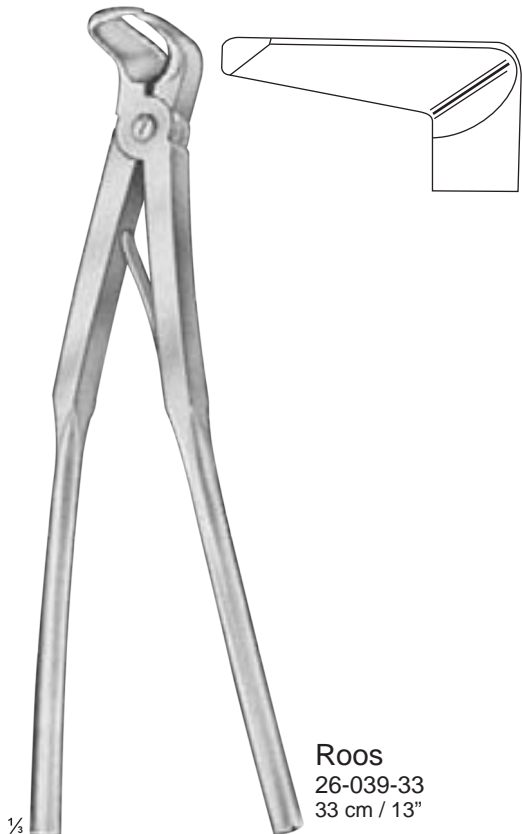

Roos
26-039-33
33 cm / 13"



Schumacher
26-042-22
22 cm / 8¾"

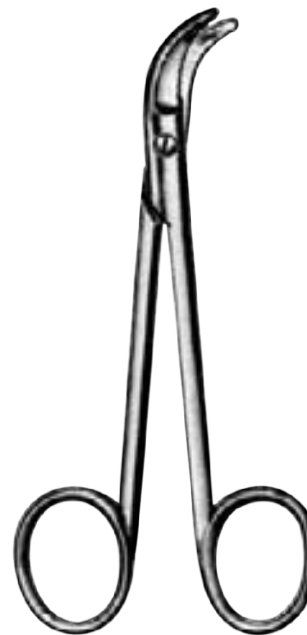

Potts
26-044-15
15 cm / 6"

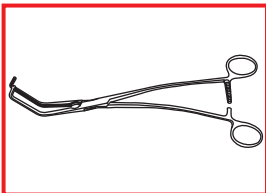

Rib Shears

Rippenscheren

Costotomes

Costótomos

Costotomi

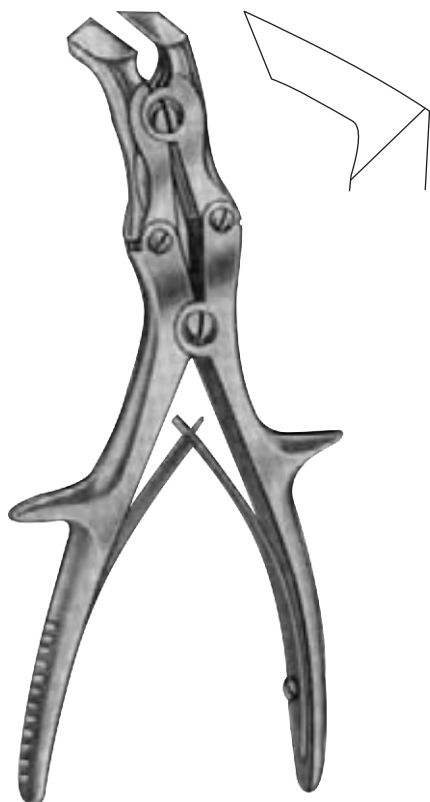

Tudor-Edwards
26-052-27
27 cm / 10½"



Doyen
26-054-18
18 cm / 7¼"

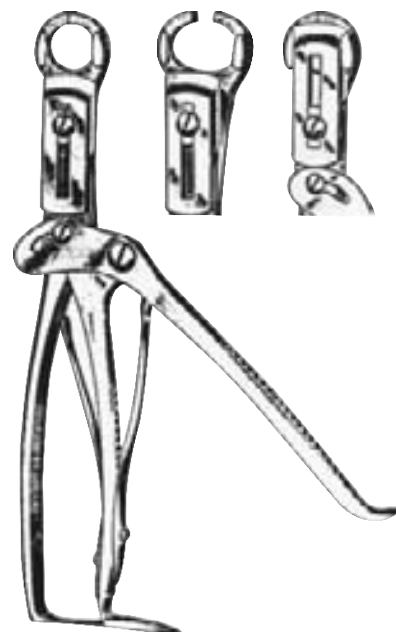

Vermehren
(Tuder Edward)
26-057-24
24 cm / 9½"



Crafoord
26-060-28
28 cm / 11"

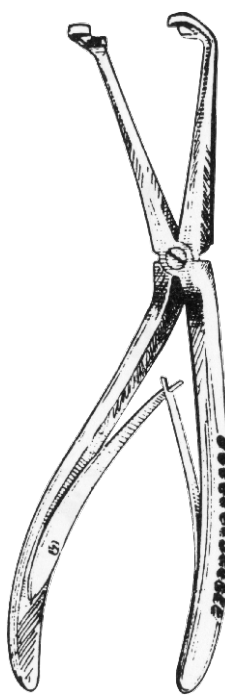

Morrision-Davies
26-062-30
30 cm / 12"

Rib Approximators

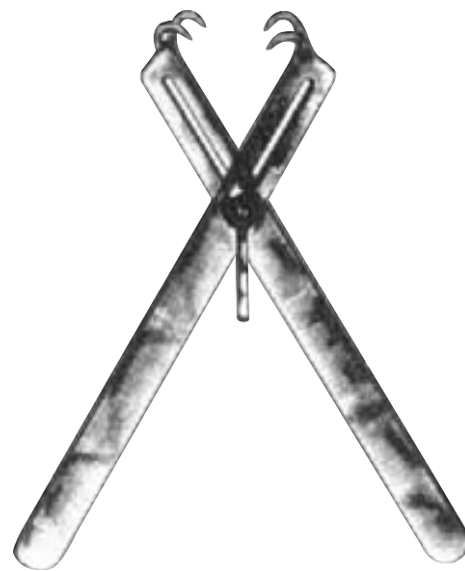

Robert
(Pair)
26-065-23
23 cm / 9"

Rib Retractors

Rippensperrer
Separadores costales

Ecarteurs des côtes
Divaricatori costali

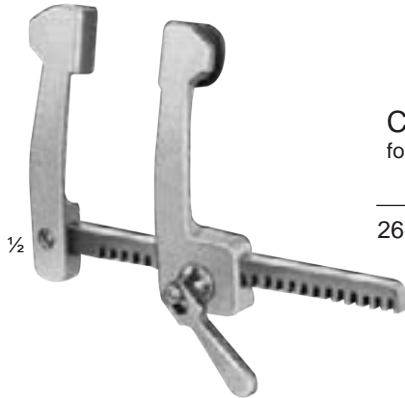
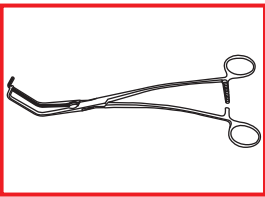

Cooley
for newborns

	a	b	c
26-070-01	12 mm	17 mm	75 mm

Aluminium

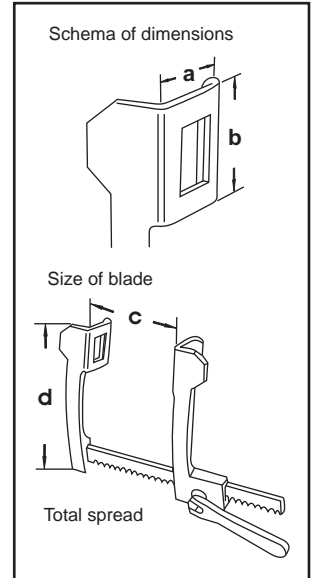

Cooley
Pediatric size

	a	b	c
26-070-02	16 mm	30 mm	105 mm
26-070-03	21 mm	44 mm	150 mm

Aluminium



Cooley
for adults

	a	b	c
26-070-04	37 mm	49 mm	200 mm

Stainless Steel

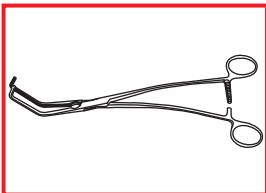

Rib Retractors

Rippensperrer
Separadores costales

Ecarteurs des côtes
Divaricatori costali

Aluminium



for babies

Finocchietto - Infant

	a	b	c
26-075-01	15 mm	15 mm	75 mm



child size

Finocchietto - Baby - Haight

	a	b	c
26-076-01	31 mm	31 mm	100 mm

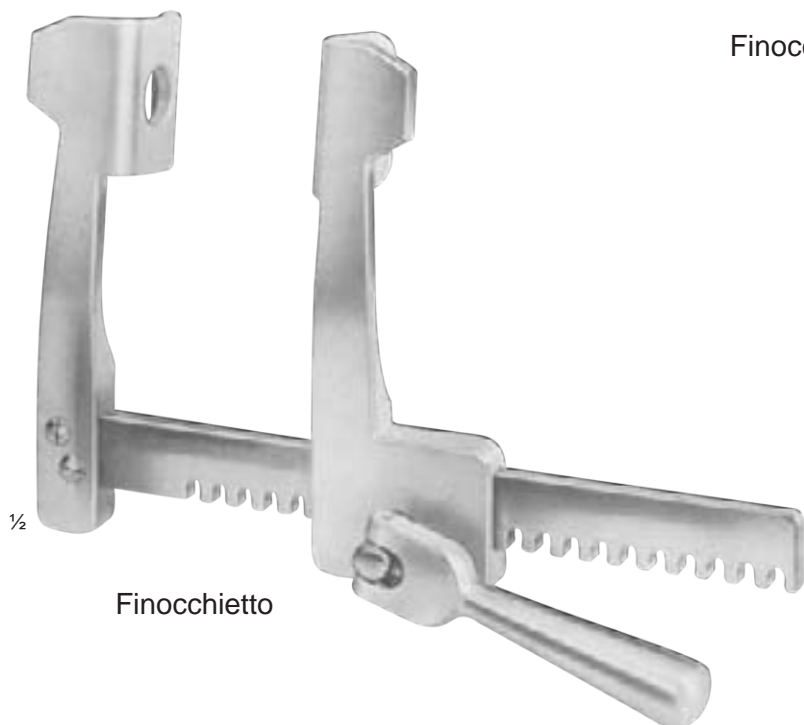

Finocchietto

	a	b	c
26-077-01	38 mm	44 mm	135 mm
26-077-02	52 mm	62 mm	175 mm
26-077-03	85 mm	65 mm	175 mm

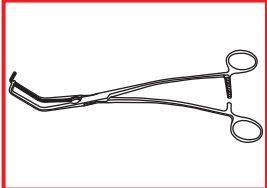

Rib Retractors

Rippensperrer
Separadores costales

Ecarteurs des côtes
Divaricatori costali

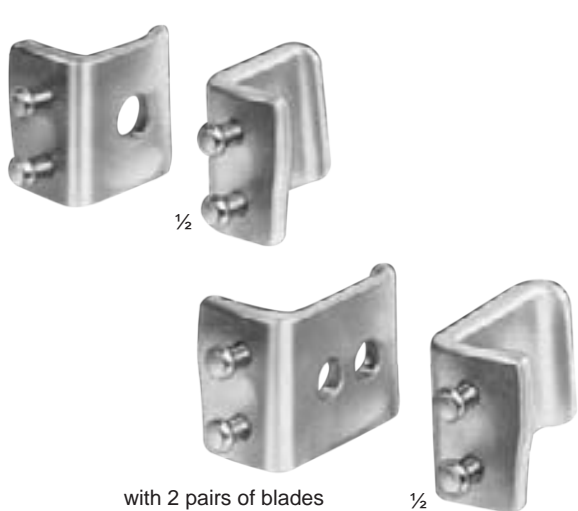

with 2 pairs of blades

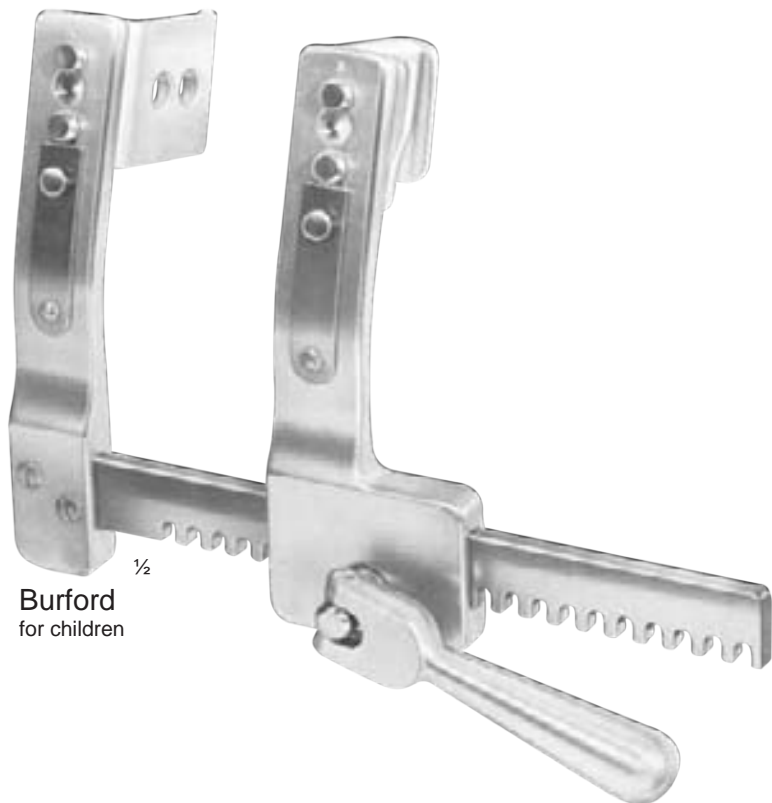

Burford
for children

	a	b	c
26-082-00	48 mm	42 mm	135 mm
26-082-01	34 mm	42 mm	135 mm

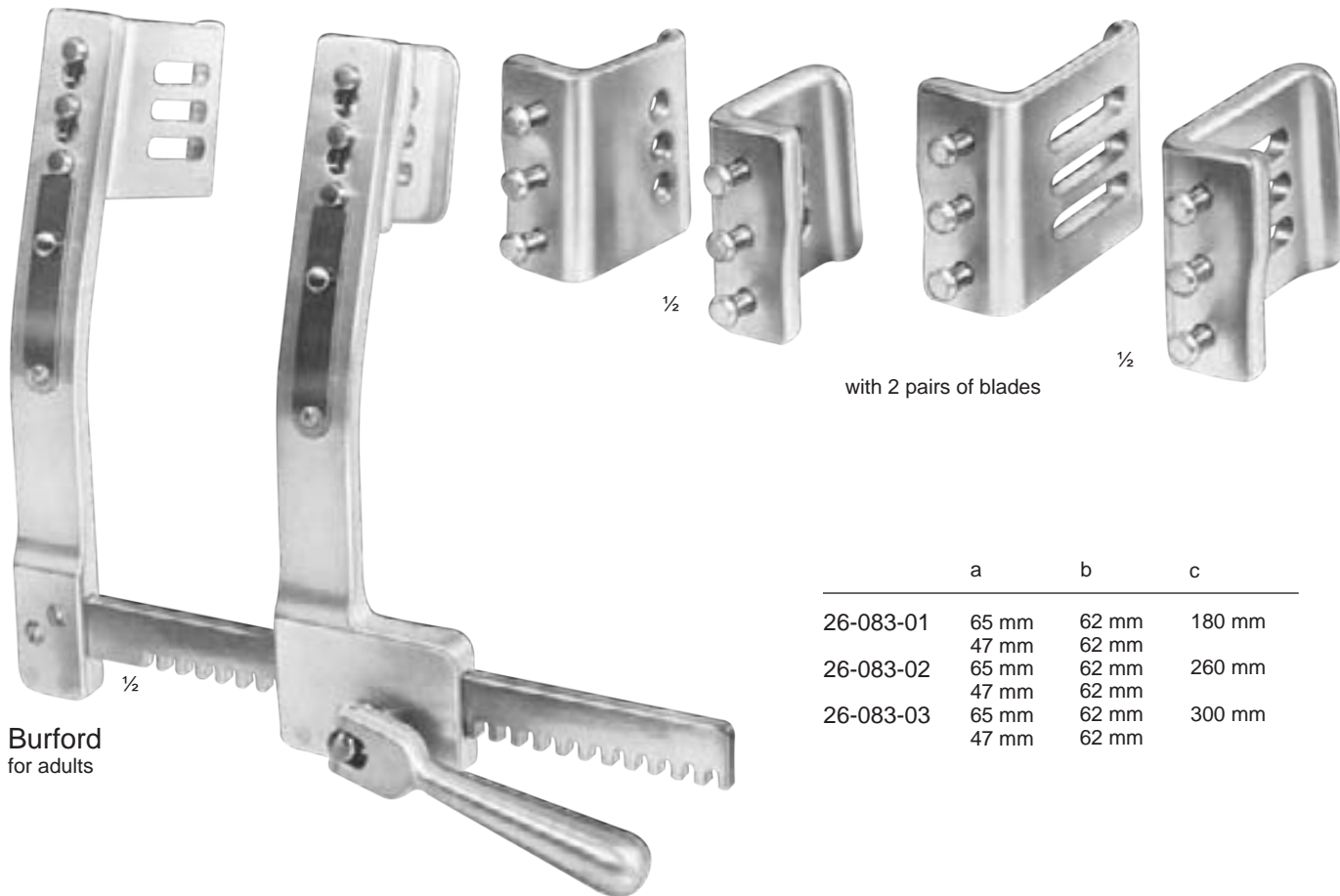

Burford
for adults

	a	b	c
26-083-01	65 mm 47 mm	62 mm 62 mm	180 mm
26-083-02	65 mm 47 mm	62 mm 62 mm	260 mm
26-083-03	65 mm 47 mm	62 mm 62 mm	300 mm



Rib Retractors

Rippensperrer
Separadores costales

Ecarteurs des côtes
Divaricatori costali

Aluminium



Castaneda
(New Born)

	a	b	c
26-090-01	10.5 mm	32 mm	65 mm



Castaneda
(Infant)

	a	b	c
26-090-02	12 mm	45 mm	70 mm



Castaneda
(Child)

	a	b	c
26-090-03	15 mm	60 mm	120 mm

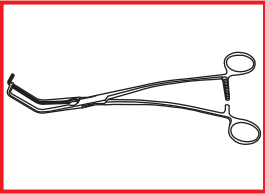

Rib Retractors

Rippensperrer
Separadores costales

Ecarteurs des côtes
Divaricatori costali

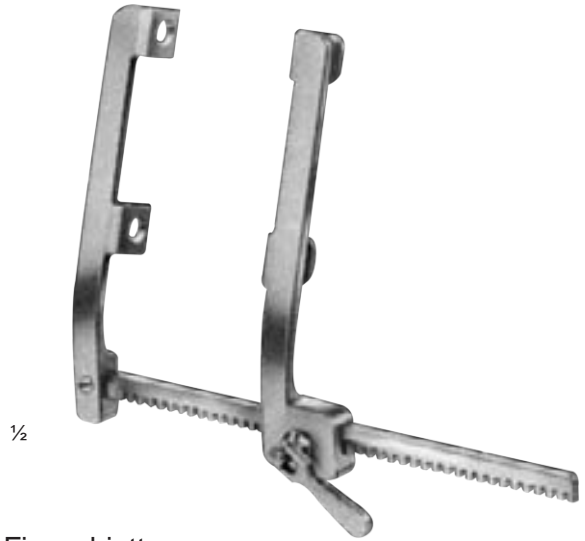

Finocchietto

	a	b	c	d
26-095-01	14 mm	14 mm	120 mm	110 mm



Haight

	a	b	c
26-096-90	30 mm	30 mm	90 mm

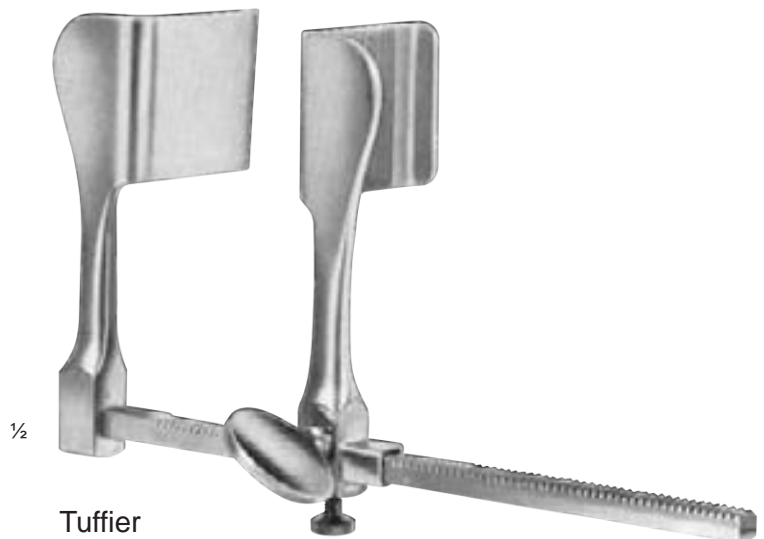

Tuffier

	a	b	c
26-098-02	50 mm	45 mm	165 mm



Rib Retractors

Rippensperrer
Separadores costales

Ecarteurs des côtes
Divaricatori costali

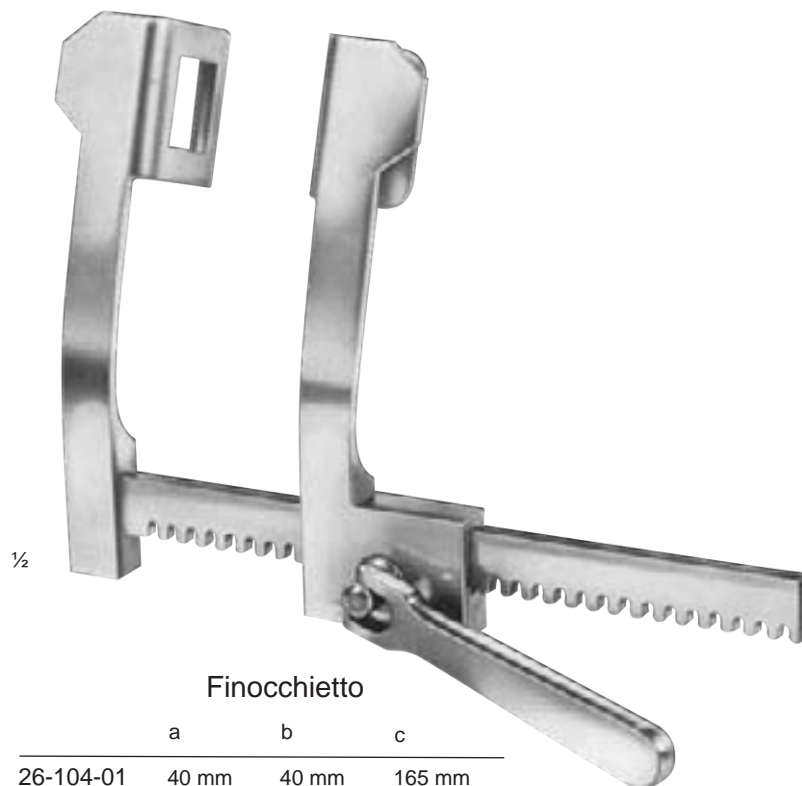

Finocchietto

	a	b	c
26-104-01	40 mm	40 mm	165 mm
26-104-02	45 mm	65 mm	200 mm
26-104-03	70 mm	65 mm	250 mm

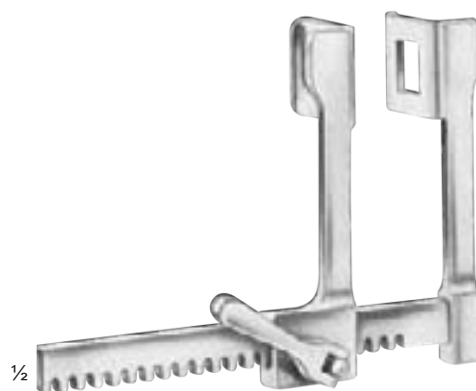

Finocchietto - Baby

	a	b	c
26-105-75	18 mm	20 mm	75 mm

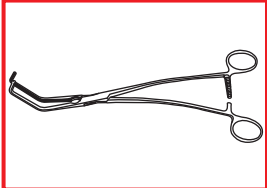

Rib Retractors

Rippensperrer
Separadores costales

Ecarteurs des côtes
Divaricatori costali

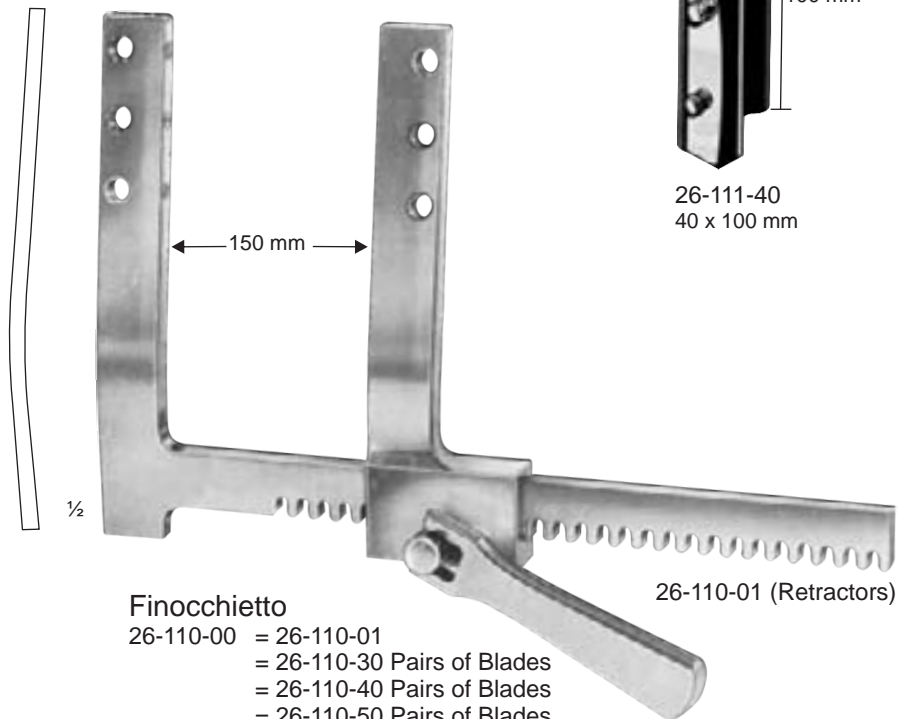
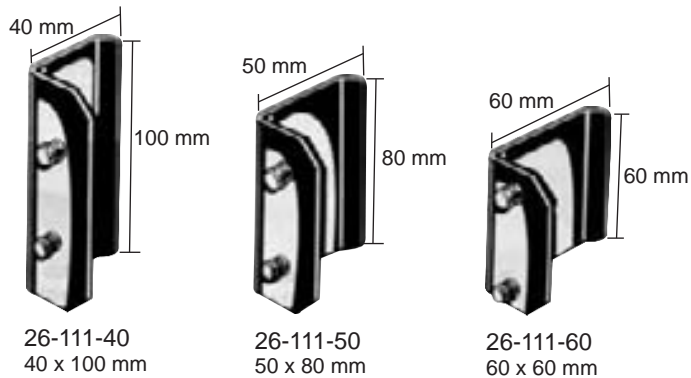
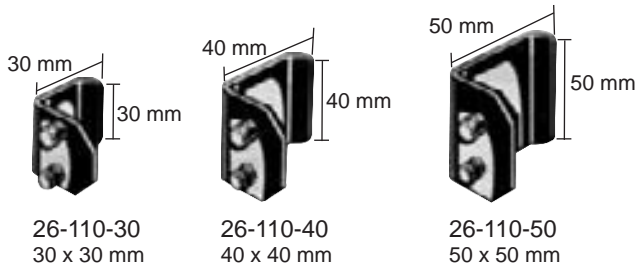

Finocchetto

- 26-110-00 = 26-110-01
- = 26-110-30 Pairs of Blades
- = 26-110-40 Pairs of Blades
- = 26-110-50 Pairs of Blades

Complete Set

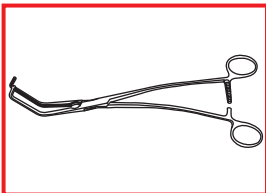

Rib Retractors

Rippensperrer
Separadores costales

Ecarteurs des côtes
Divaricatori costali

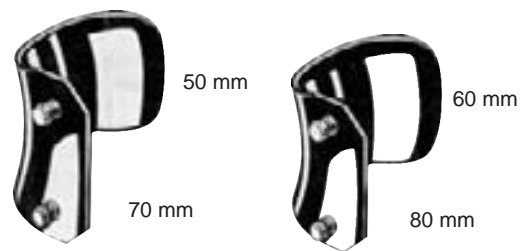

26-119-70
70 x 50 mm

26-119-80
80 x 60 mm

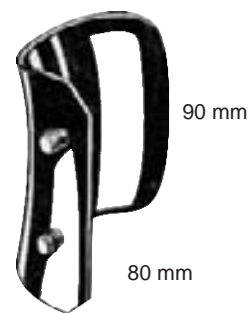

26-119-81
80 x 90 mm

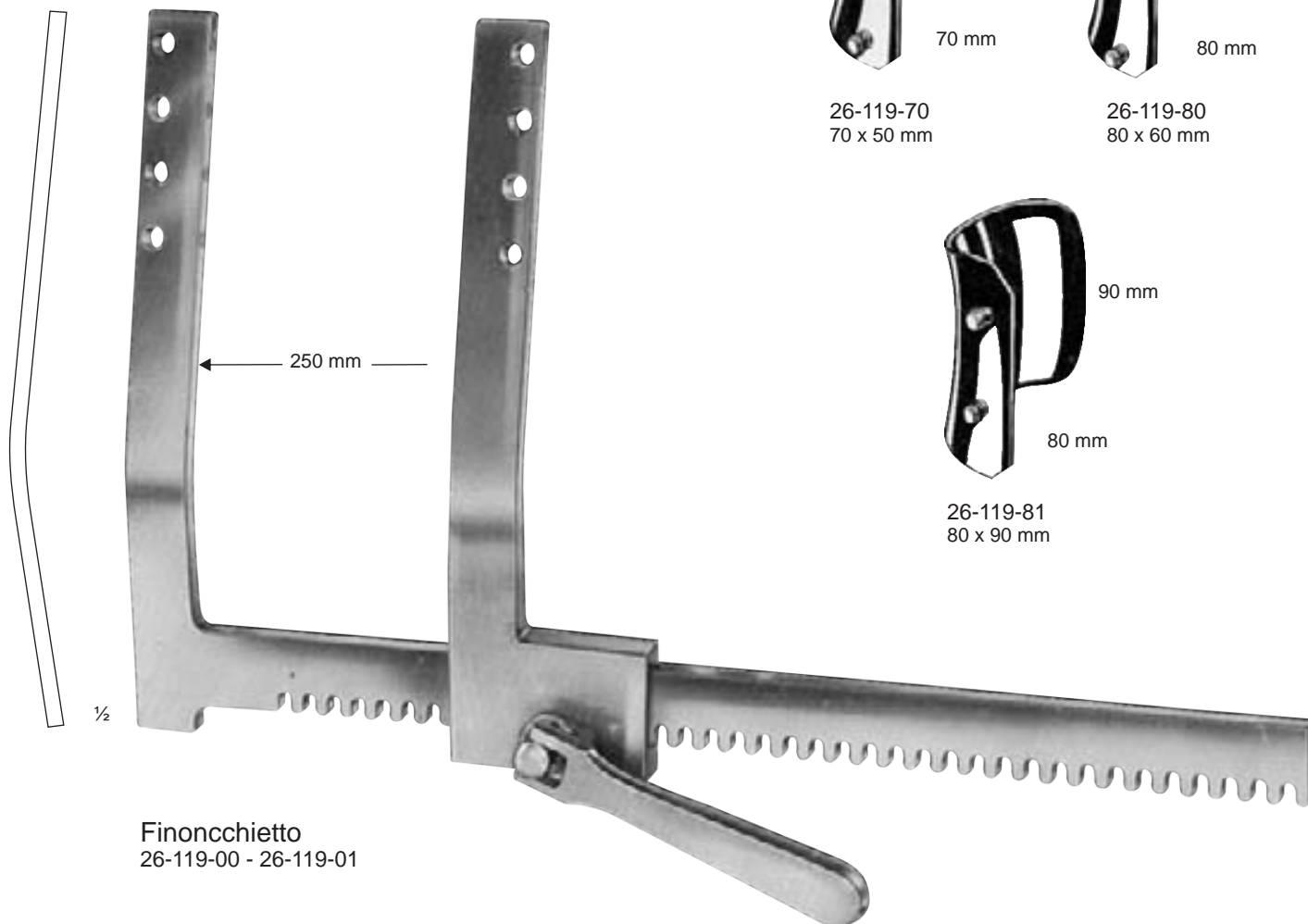

Finoncchetto
26-119-00 - 26-119-01

26-119-00 Retractor, Large Size, with 3 pair of exchangeable blades

26-119-01 Retractor, Large Size, only



Thoracic Retractor

Thoraxsperrer
Separador torácico

Ecarteur thoracique
Divaricatore per il torace

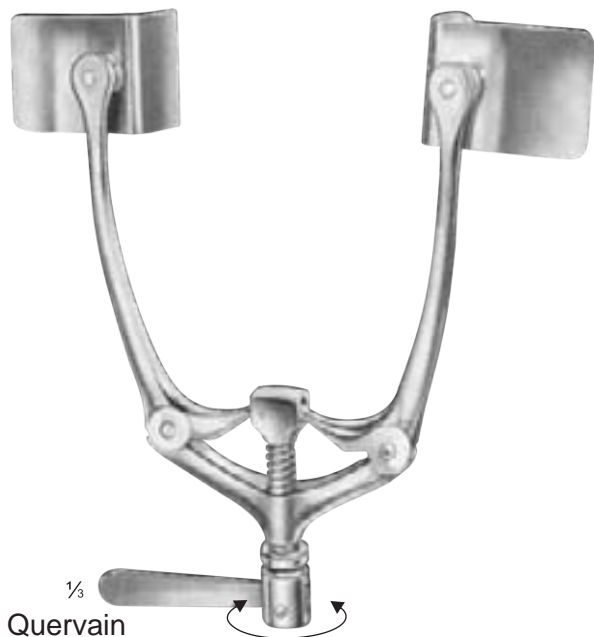

$\frac{1}{3}$
Quervain

	a	b	c
26-124-00	35 mm	50 mm	180 mm

26-125-75 = 75 x 75 mm



26-125-65 = 42 x 65 mm



26-125-00
Thoracic retractor (Mercedes-Retractor) complete
consisting of:
Retractor only = 26-125-01
1 Pair of blades 42 x 65 mm = 26-125-65
1 Pair of blades 75 x 75 mm = 26-125-75

26-125-01
Retractor only



Rib Retractors

Rippensperrer
Separadores costales

Ecarteurs des côtes
Divaricatori costali



26-130-01
30 x 30 mm



26-130-02
40 x 40 mm



26-130-03
50 x 50 mm

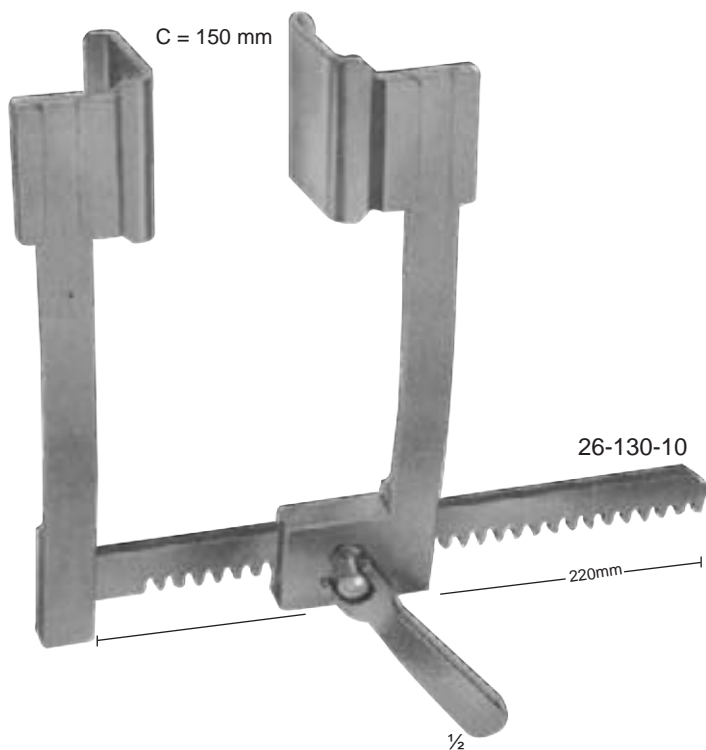

Debakey
26-130-00 = 1 x 26-130-10
+ 2 x 26-130-01
+ 2 x 26-130-02
+ 2 x 26-130-03



Rib Retractors

Rippensperrer
Separadores costales

Ecarteurs des côtes
Divaricatori costali

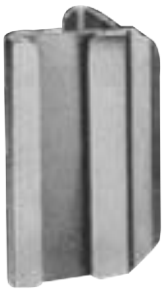

26-137-01
60 x 60 mm



26-137-02
50 x 80 mm

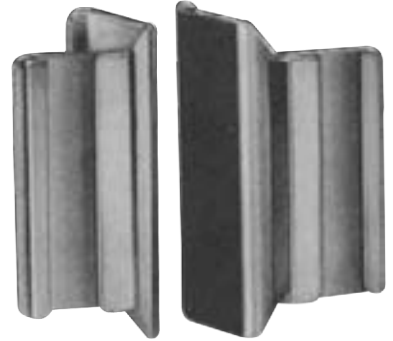

26-137-03
40 x 100 mm



26-137-10
Retractor only

½

Debakey

26-137-00 = 1 x 26-137-10
+ 2 x 26-137-01
+ 2 x 26-137-02
+ 2 x 26-137-03
with 3 Pairs of Blades

Rib Contractors,Lung Spatulas

Rippenkontraktoren,Lungenspatel

Rapprocheurs des côtes,Spatules pulmonaires

Aproximadores para costillas,Espátulas pulmonares

Approssimatori costali,Spatole per pulmone

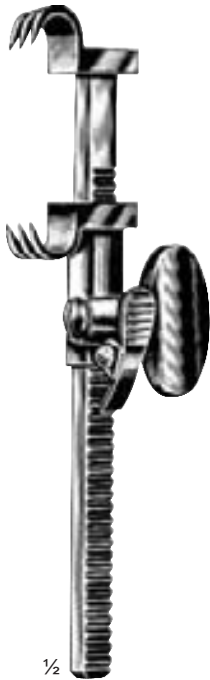

1/2

Bailey
26-142-16
16 cm / 6 1/4"



Bailey-Gibbon
26-144-16
16 cm / 6 1/4"



1/2

Bailey-Baby
26-146-14
14 cm / 5 1/2"



1/2

Sellors
26-148-19
19 cm / 7 1/2"



1/3

26-151-26
26 cm / 10 1/4"



1/3

Allison
26-153-30 = 30 cm / 12"
26-153-32 = 32 cm / 12 1/2"

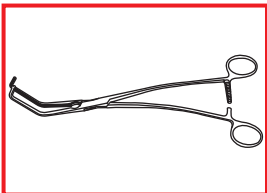

Bronchus Clamps

Bronchusklemmen
Pinzas bronquiales

Pince-clamps à bronches
Pinze per bronchi

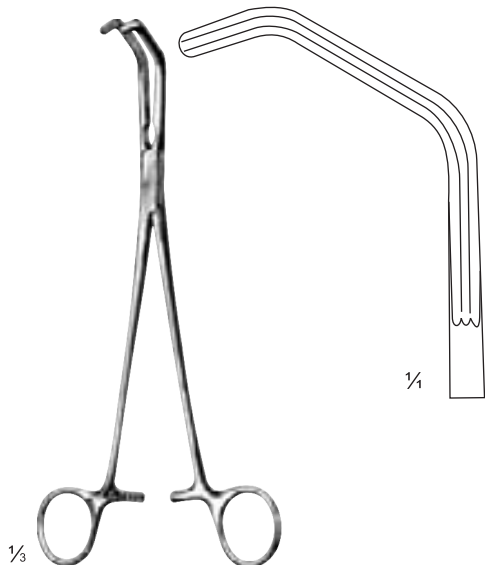

Price-Thomas
26-159-22
22 cm / 8 3/4"

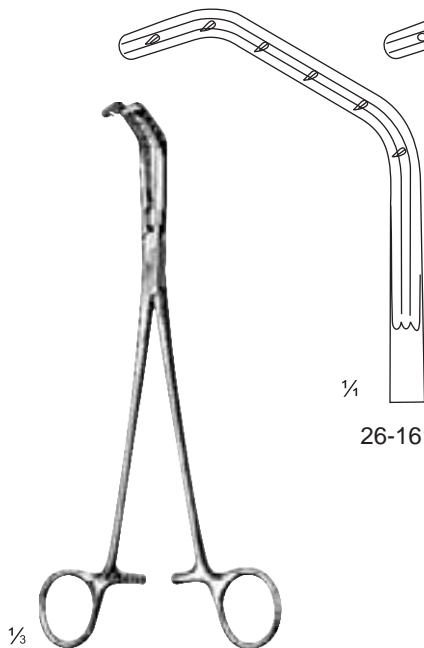

Price-Thomas
26-161-22 - 26-163-22
22 cm / 8 3/4"

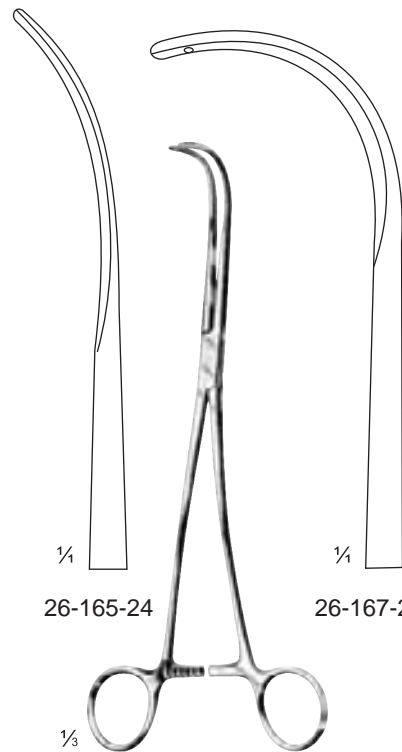

Semb
26-165-24 - 26-167-24
24 cm / 9 1/2"

Lung Grasping Forceps

Lungenfasszangen
Pinzas para coger el pulmón

Pince-clamps au poumon
Pinze per afferrare polmone

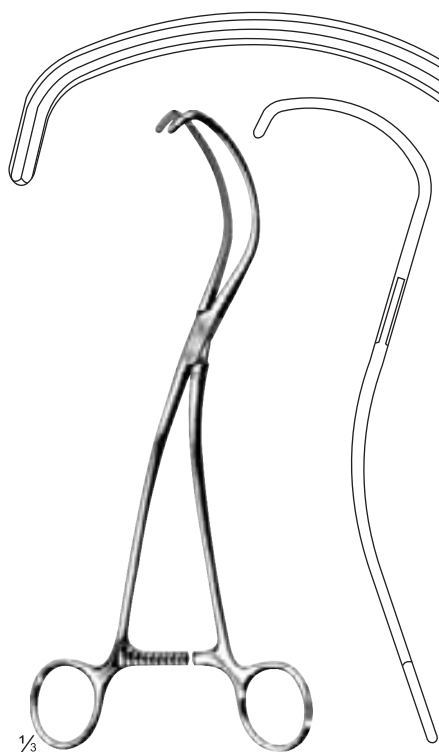
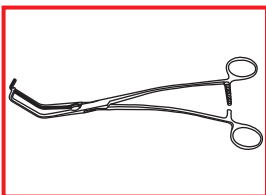

$\frac{1}{3}$
Derra
26-173-24
24 cm / 9½"

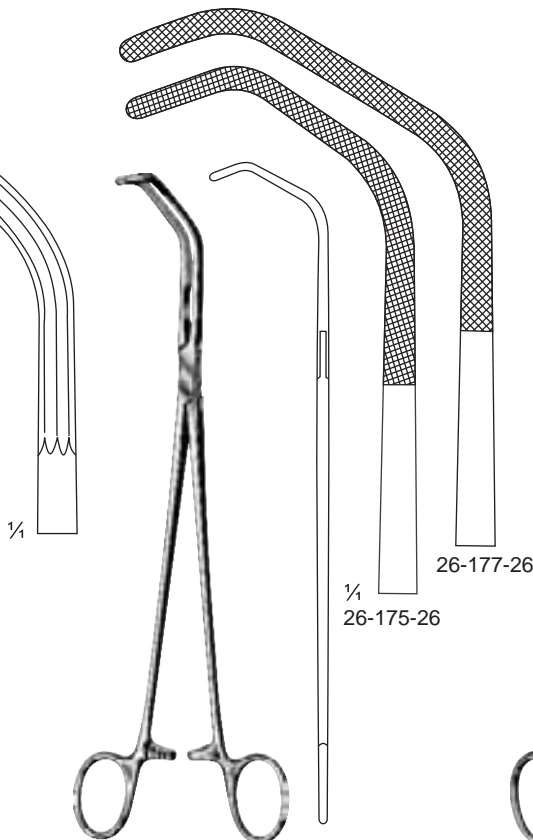

Satinsky
26-175-26 = Fig. 1
26-177-26 = Fig. 2
26.5 cm / 10½"

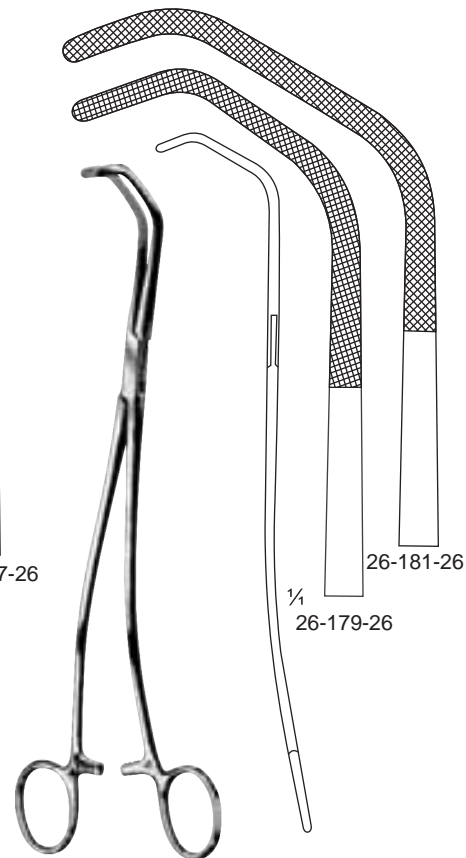

Satinsky
26-179-26 = Fig. 1
26-181-26 = Fig. 2
26.5 cm / 10½"

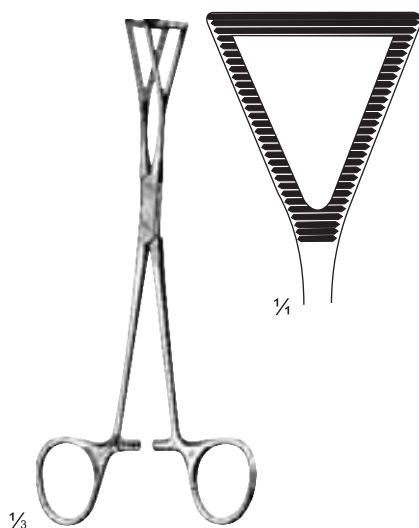

$\frac{1}{3}$
Lovelace
26-183-20
20 cm / 8"



$\frac{1}{3}$
Lovelace
26-185-20
20 cm / 8"

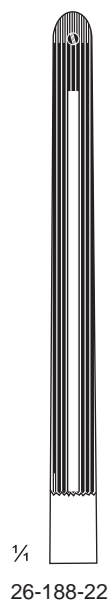

$\frac{1}{3}$
Johns Hopkins
22 cm / 8¾"



$\frac{1}{4}$
26-189-22

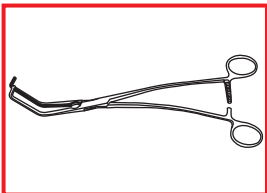

Multi Purpose Vascular Clamps

Mehrzweck-Gefäßklemmen
Pinzas vasculares de usos múltiples

Pinces vasculaires universelles
Pinze vascolari universali



$\frac{1}{2}$
Derra
26-195-18 - 26-199-18
18 cm / 7"

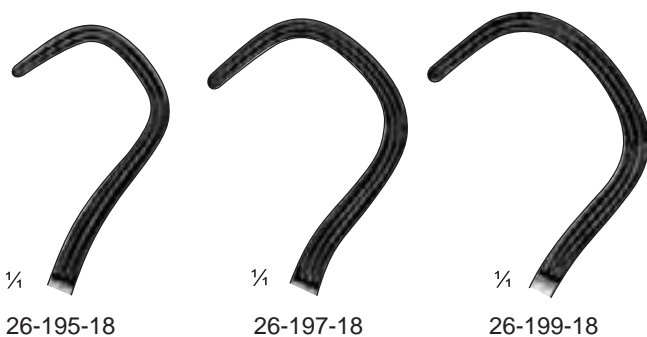

$\frac{1}{4}$
26-195-18

$\frac{1}{4}$
26-197-18

$\frac{1}{4}$
26-199-18

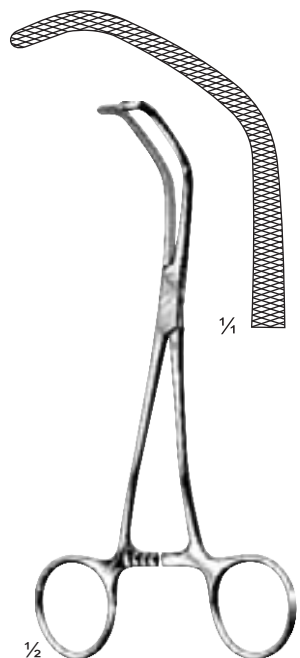

$\frac{1}{2}$
Baby-Satinsky
26-201-15
15 cm / 6"

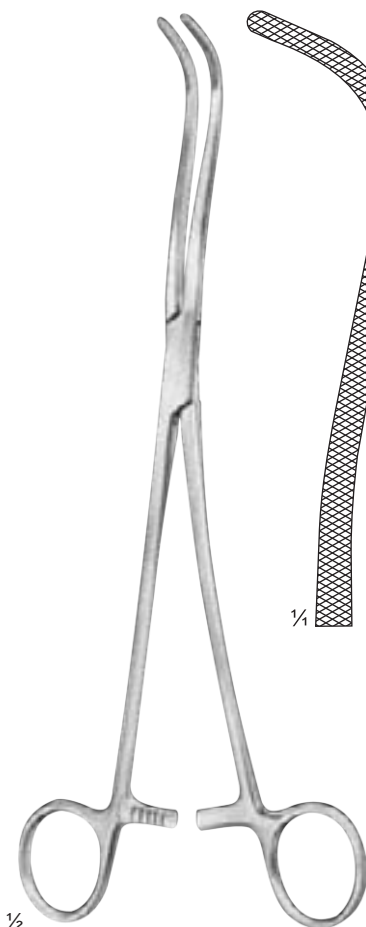

$\frac{1}{2}$
Harken
26-203-24
24 cm / 9½"

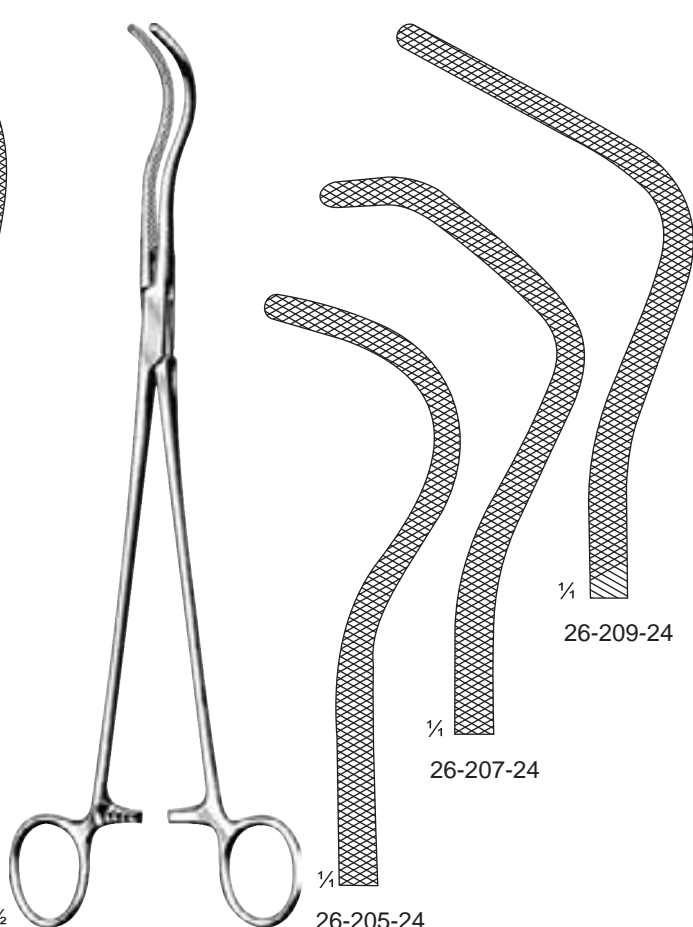

$\frac{1}{2}$
Harken
24 cm / 9½"

$\frac{1}{4}$
26-207-24

$\frac{1}{4}$
26-209-24

$\frac{1}{4}$
26-205-24



Bronchus Clamps

Bronchusklemmen
Pinzas bronquiales

Pince-clamps à bronches
Pinze per bronchi



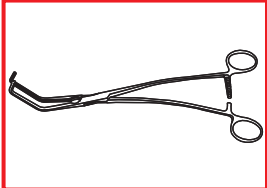

Multi Purpose Vascular Clamps

Mehrzweck-Gefäßklemmen
Pinzas vasculares de usos múltiples

Pinces vasculaires universelles
Pinze vascolari universali

ATRAUMA



De Bakey
2:3 rows of teeth

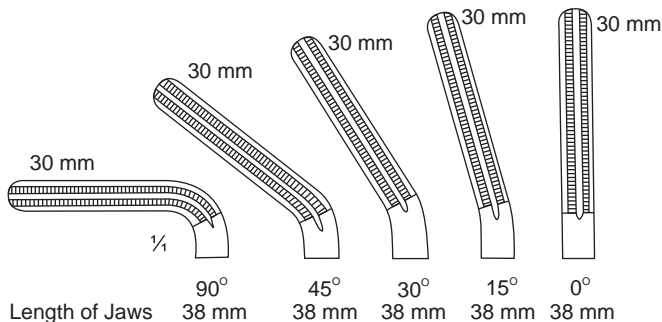

	cm	inch.	angle	weight
26-227-00	15	6	0°	28 g
26-227-15	15	6	15°	28 g
26-227-30	15	6	30°	28 g
26-227-45	15	6	45°	28 g
26-227-90	14	5 ½	90°	28 g



Dardik

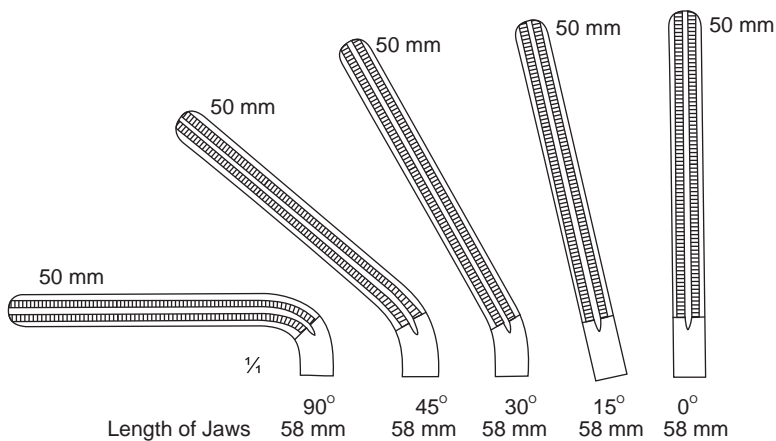

	cm	inch.	angle	weight
26-229-00	17	6¾	0°	28 g
26-229-15	17	6¾	15°	28 g
26-229-30	17	6¾	30°	28 g
26-229-45	17	6¾	45°	28 g
26-229-90	16	6¼	90°	28 g

Multi Purpose Vascular Clamps

Mehrzweck-Gefäßklemmen
Pinzas vasculares de usos múltiples

Pinces vasculaires universelles
Pinze vascolari universali

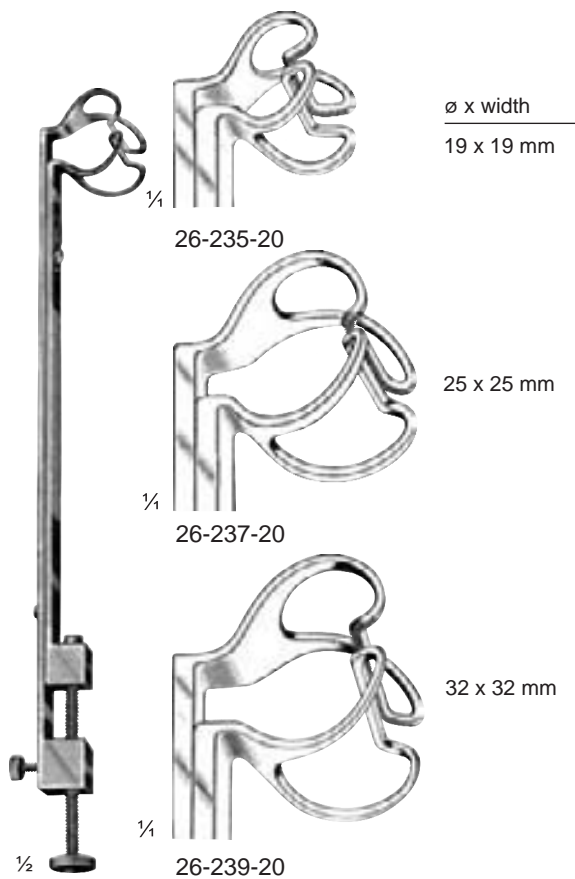

Johns Hopkins
20 cm / 8"

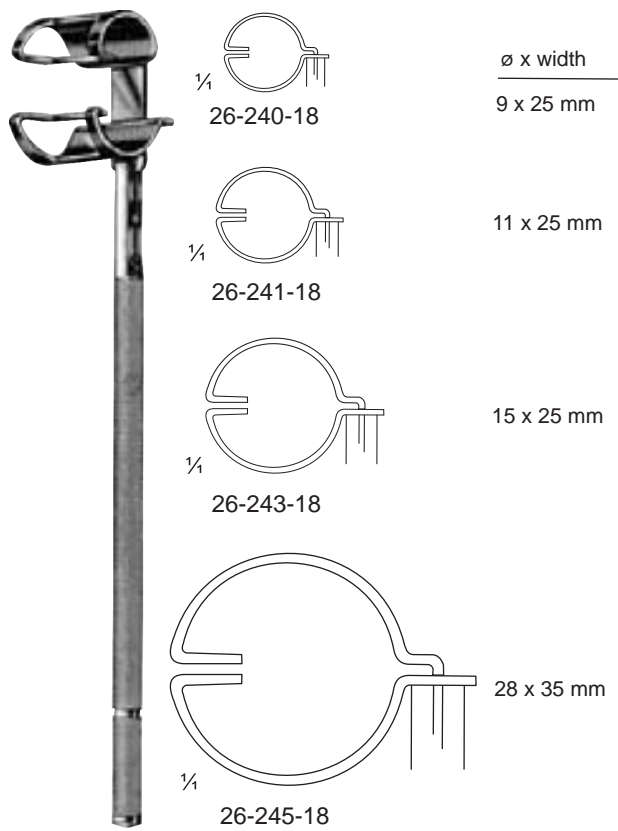

Potts-Smith
18 cm / 7"

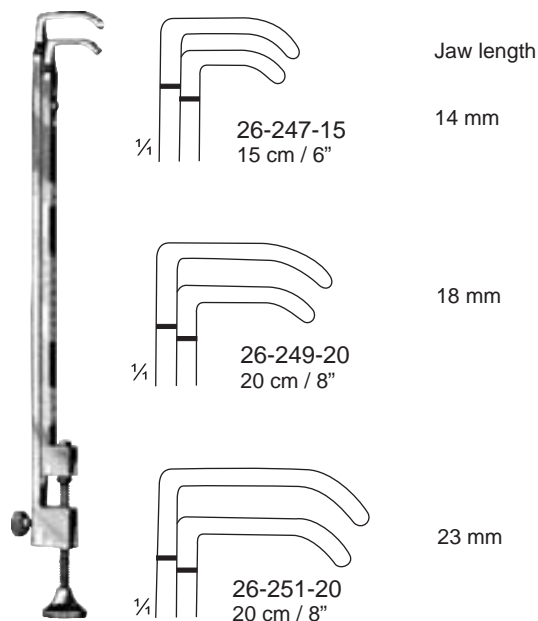

Blalock

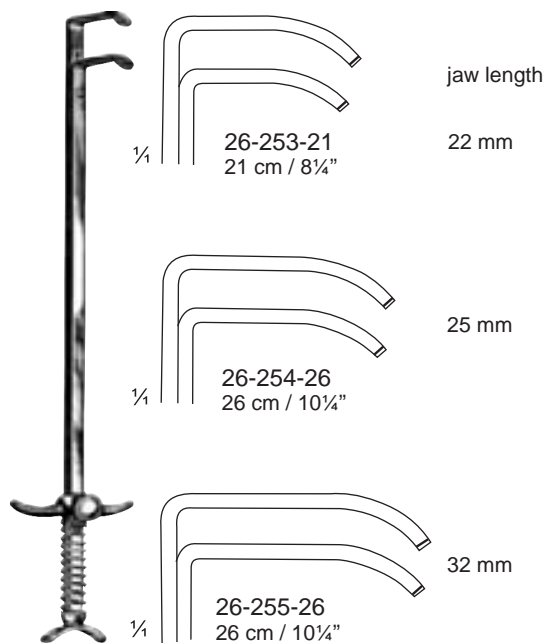

Blalock



ATRAUMA

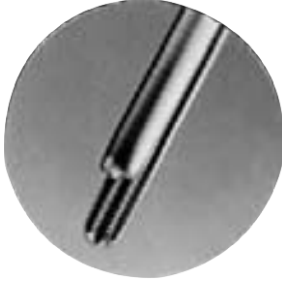

Serrations
Dentados

De Bakey
1:2 rows of teeth

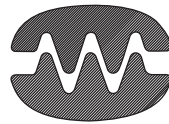

De Bakey
2:3 rows of teeth

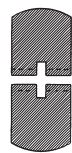
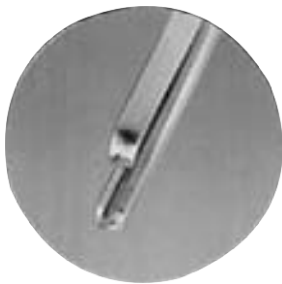

De Bakey
2:2 rows of teeth

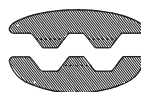
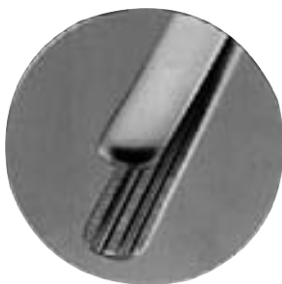

De Bakey
2:3 rows of teeth

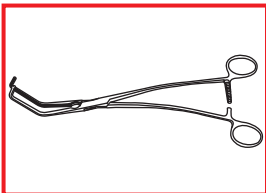

Bulldog Clamps

Bulldogklemmen
Clamps Bulldog

Clamps Bulldog
Clamps Bulldog



De Bakey
1:2 rows of teeth

ATRAUMA

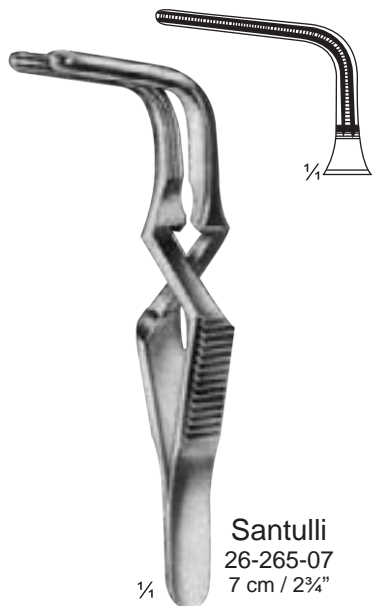

Santulli
26-265-07
7 cm / 2¾"

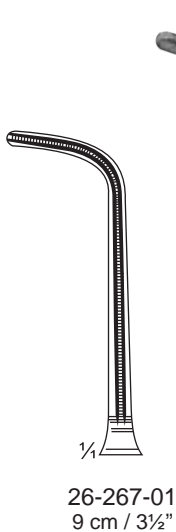

26-267-01
9 cm / 3½"



Greagory-soft
26-267-01 - 26-267-04
(Carotis)

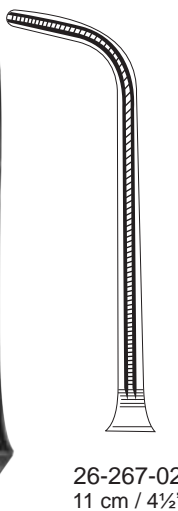

26-267-02
11 cm / 4½"

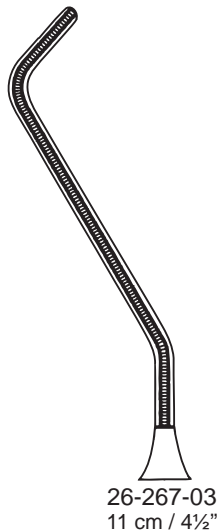

26-267-03
11 cm / 4½"

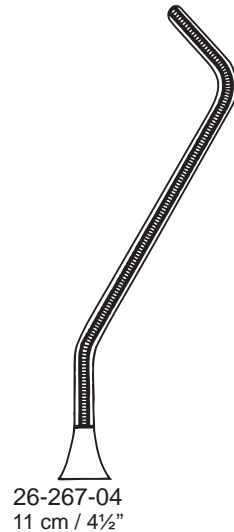

26-267-04
11 cm / 4½"



De Bakey-Satinsky
26-269-07
7 cm / 2¾"

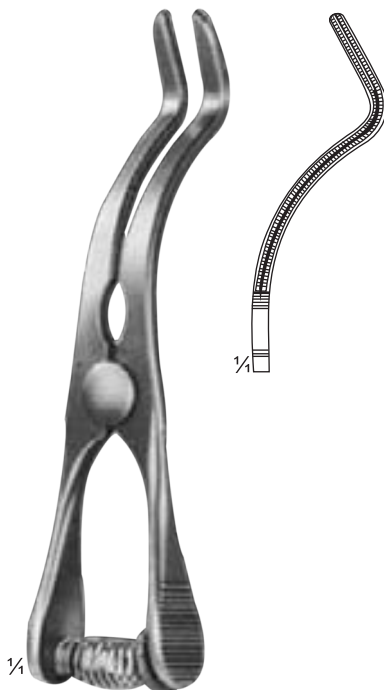

De Bakey-Carotis
26-271-09
9 cm / 3½"

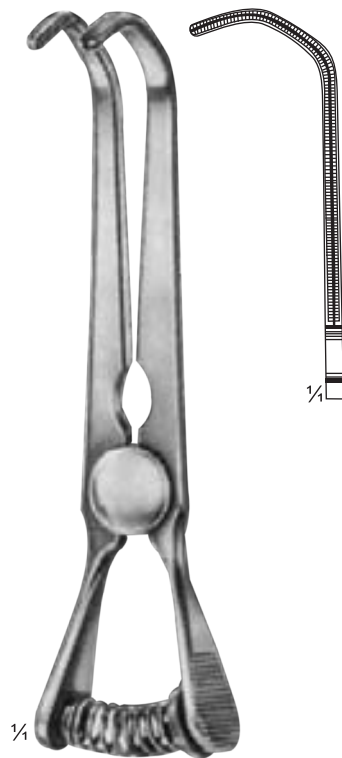

De Bakey-Satinsky
26-273-10
10 cm / 4"



Bulldog Clamps

Bulldogklemmen
Clamps Bulldog

Clamps Bulldog
Clamps Bulldog



De Bakey
1:2 rows of teeth

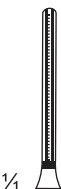

1/4
26-276-07
7.5 cm / 3"

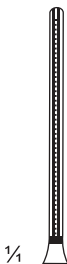

1/4
26-276-08
8.5 cm / 3 1/2"



1/4
26-276-07 - 26-276-12



1/4
26-276-10
10.5 cm / 4 1/4"



1/4
26-276-12
12 cm / 4 3/4"

ATRAUMA



1/2
Johns-Hopkins
26-279-23
23 cm / 9"

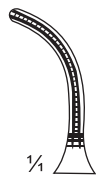

1/4
26-277-07
7 cm / 2 3/4"

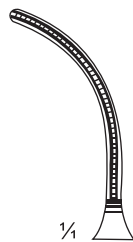

1/4
26-277-08
8 cm / 3 1/4"



1/4
26-277-07 - 26-277-12

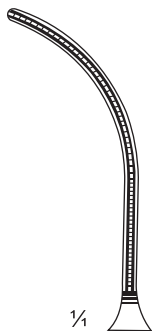

1/4
26-277-10
10 cm / 4"

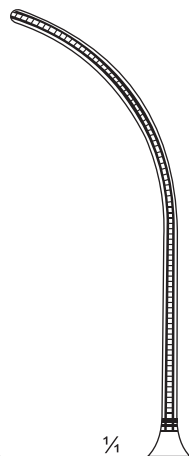

1/4
26-277-12
12 cm / 4 3/4"

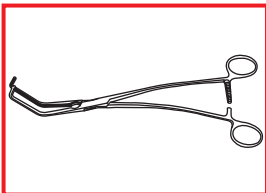

Bulldog Clamps

Bulldogklemmen
Clamps Bulldog

Clamps Bulldog
Clamps Bulldog

ATRAUMA



De Bakey
1:2 rows of teeth

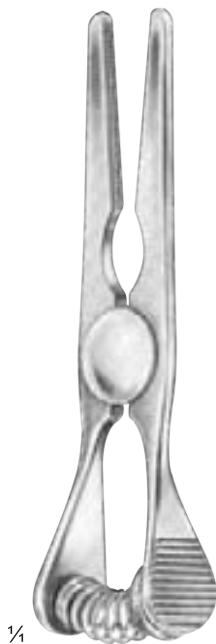
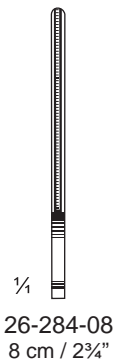
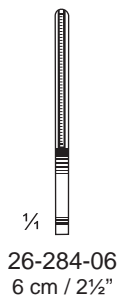

Glover
26-284-06 - 26-284-11

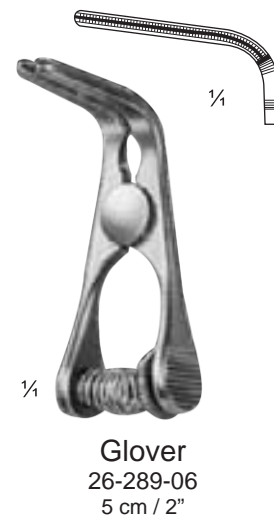
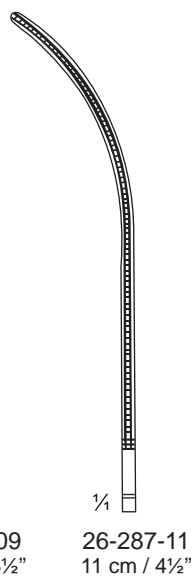
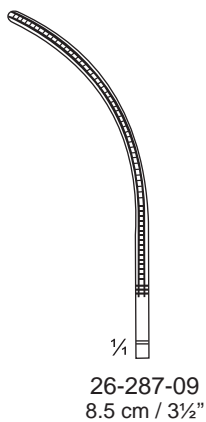
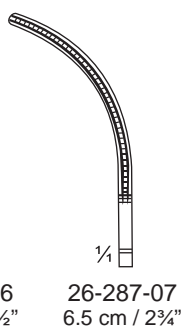
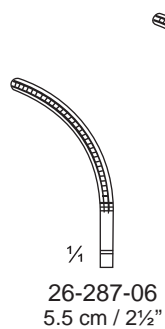
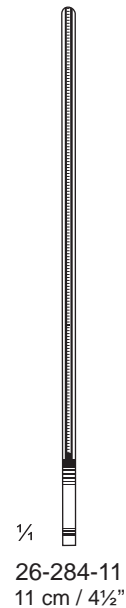
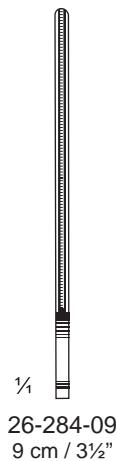

Haemostatic Forceps, Aortic Clamps

Arterienklemmen, Aortaklemmen
Pinzas hemostáticas, Pinzas aórticas

Pinces hémostatiques, Pinces-clamps pour aorte
Pinze emostatiche, Pinze per aorta

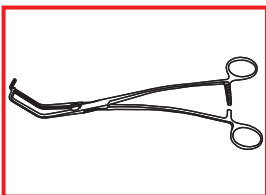

De Bakey
1:2 rows of teeth

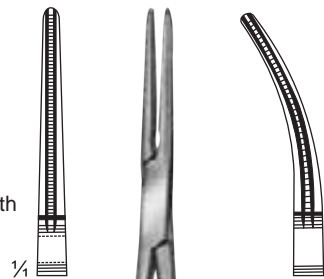

26-294-16
16 cm / 6 1/4"

26-295-16
16 cm / 6 1/4"

1/2

De Bakey-Rankin
26-294-16 - 26-295-16

ATRAUMA

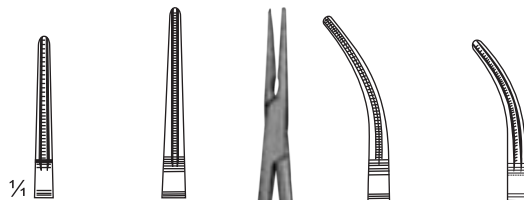

26-298-12
12 cm / 4 3/4"

26-298-15
15 cm / 6"

26-299-15
15 cm / 6"

26-299-12
12 cm / 4 3/4"

1/2

De Bakey-Mosquito
26-298-15 - 26-299-15



1/2

Ochsner
26-301-23
23.5 cm / 9 1/4"



1/4



1/2

Dietrich
26-303-21
21 cm / 8 1/4"

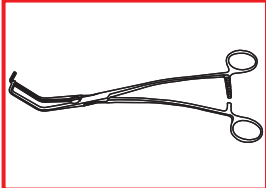

Peripheral Vascular Clamps, Profunda Clamps

Peripheral-Gefäßklemmen, Profundaklemmen
Pinzas para vasos periféricos, Pinzas para la profunda

Pinces-clamps vasculaires périphériques, Pinces fémorale
Pinze vascolari periferali, Pinze profunda



De Bakey
1:2 rows of teeth

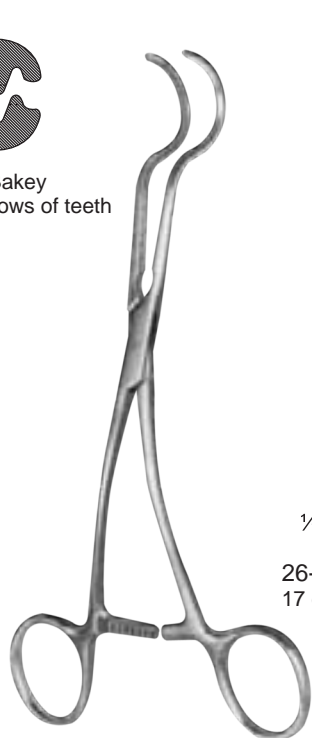

Dale
26-309-17 - 26-309-19

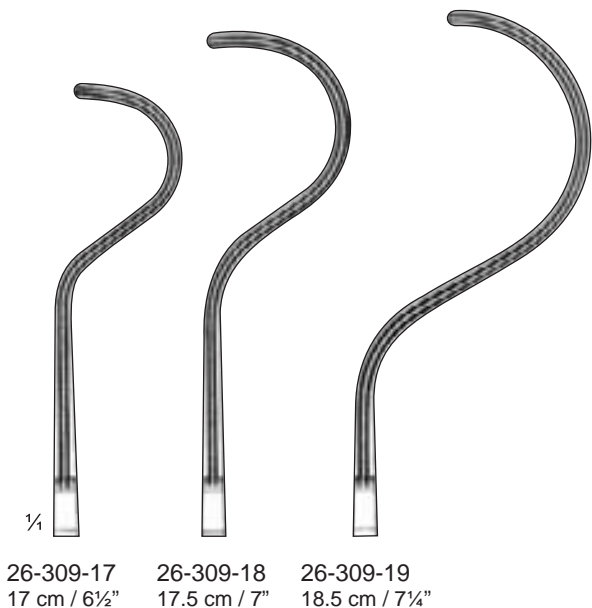

26-309-17 17 cm / 6½"
26-309-18 17.5 cm / 7"
26-309-19 18.5 cm / 7¼"

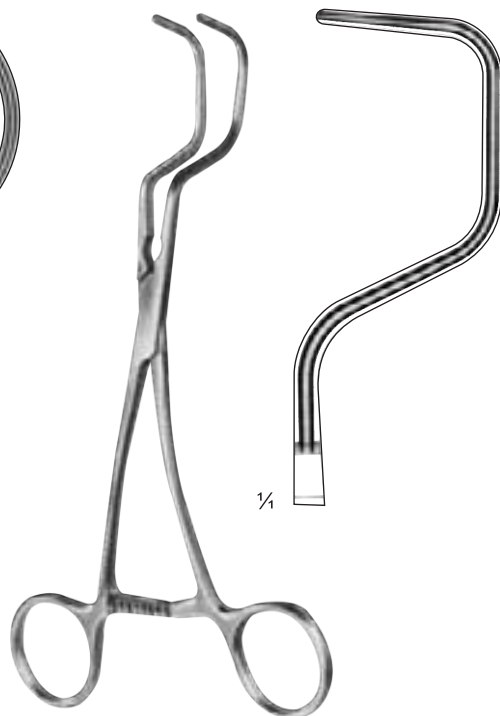

Dale
26-310-18
18.5 cm / 7"

ATRAUMA

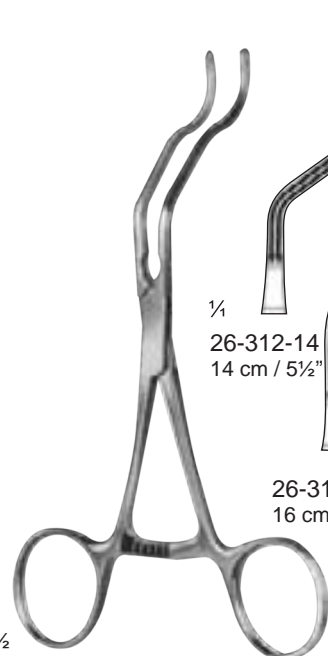

Gregory
26-312-14 - 26-312-18

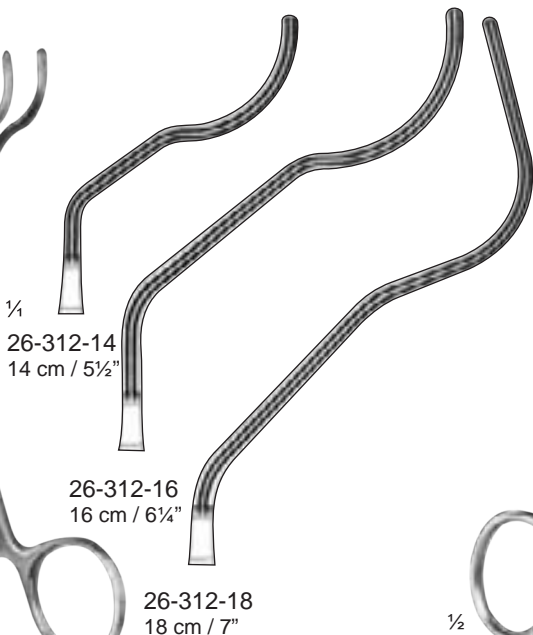

26-312-14 14 cm / 5½"
26-312-16 16 cm / 6¼"
26-312-18 18 cm / 7"

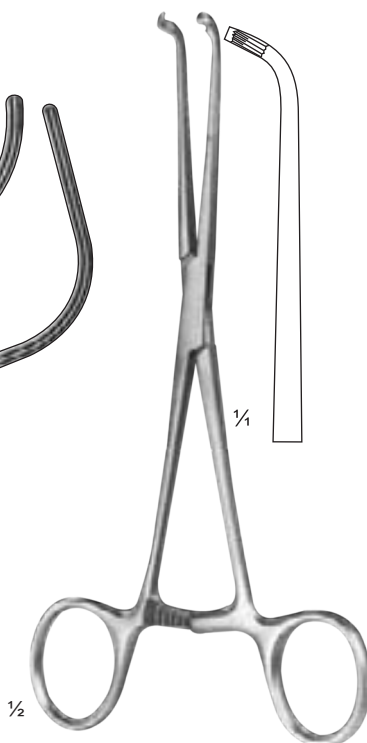

Javid
26-315-18
18 cm / 7"

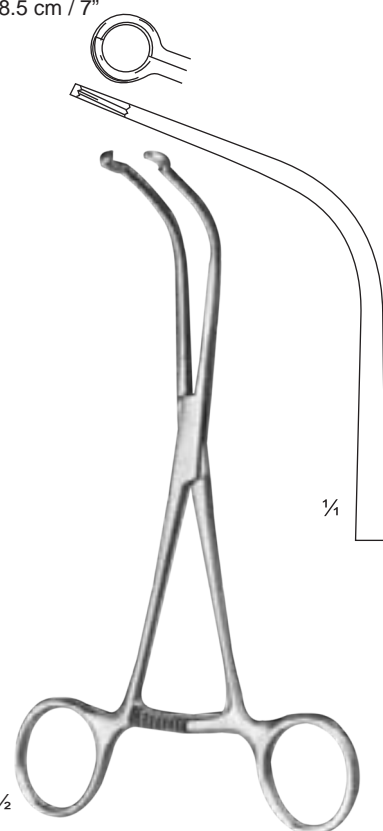

Javid
26-315-19
19 cm / 7½"

Peripheral Vascular Clamps

Peripheral-Gefäßklemmen
Pinzas para vasos periféricos

Pinces-clamps vasculaires périphériques
Pinze vascolari periferali

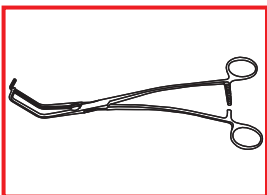

De Bakey
1:2 rows of teeth

ATRAUMA

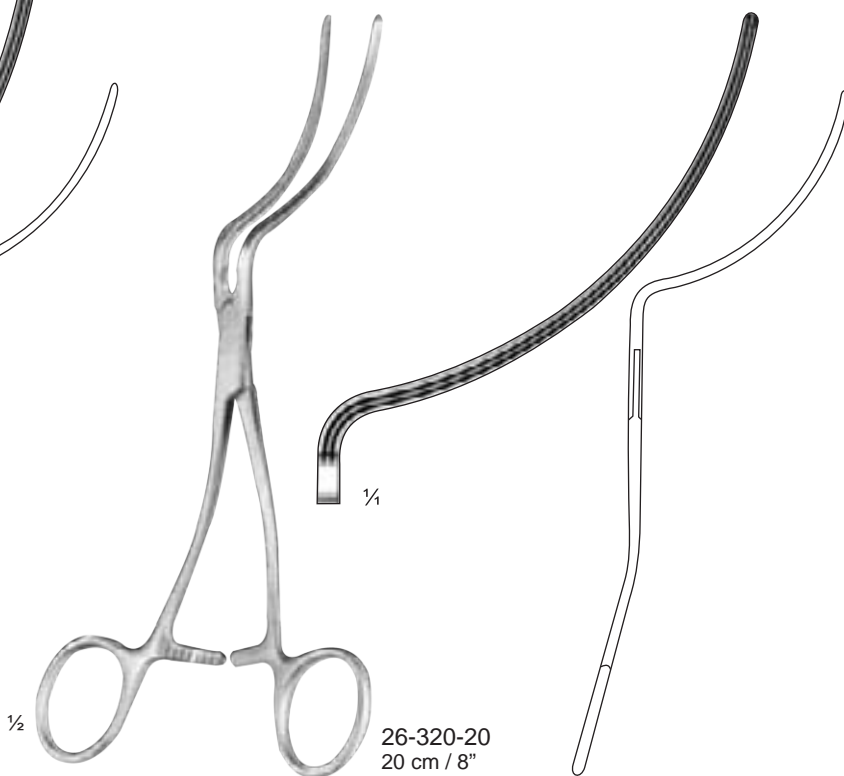
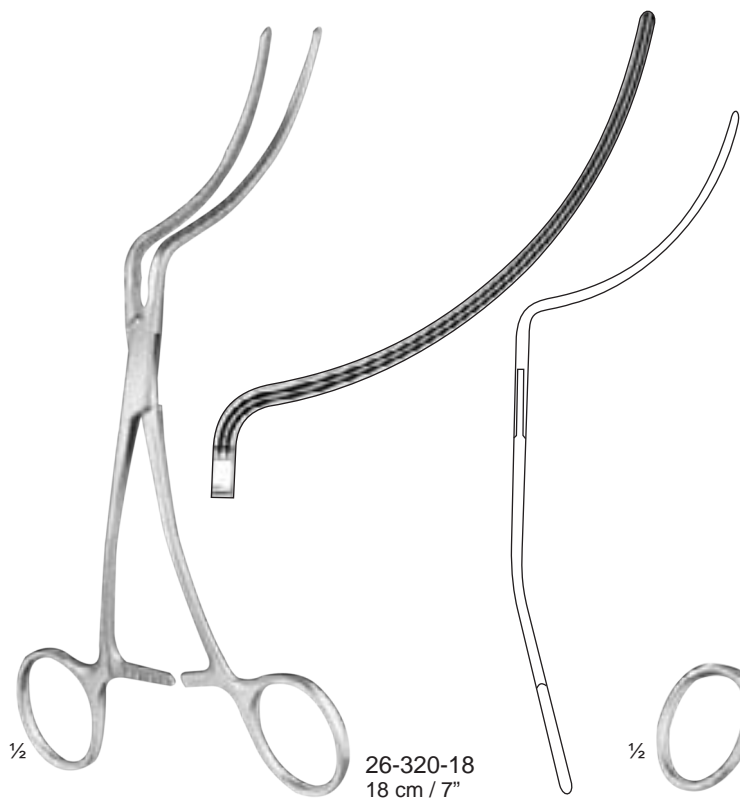
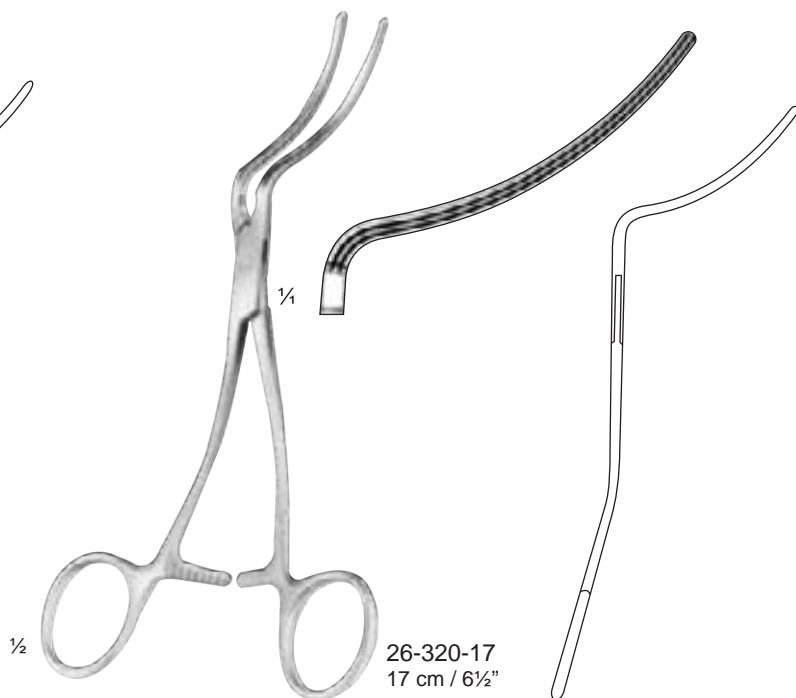
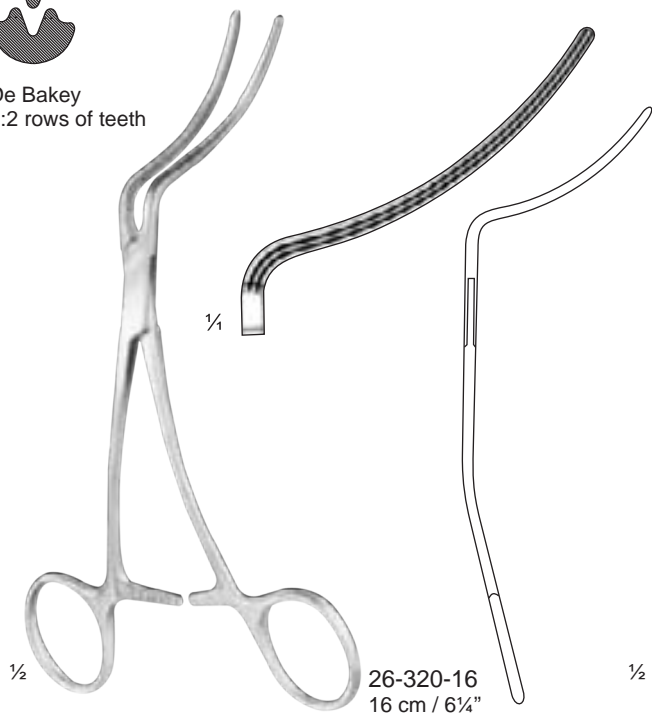



Peripheral Vascular Clamps, Catheter Clamps

Peripheral-Gefäßklemmen, Katheterklemmen
Pinzas para vasos periféricos, Pinzas para catéteres

Pinces-clamps vasculaires périphériques, Pinces pour sondes
Pinze vascolari periferali, Pinze per cateteri

ATRAUMA



26-325-18
18 cm / 7"

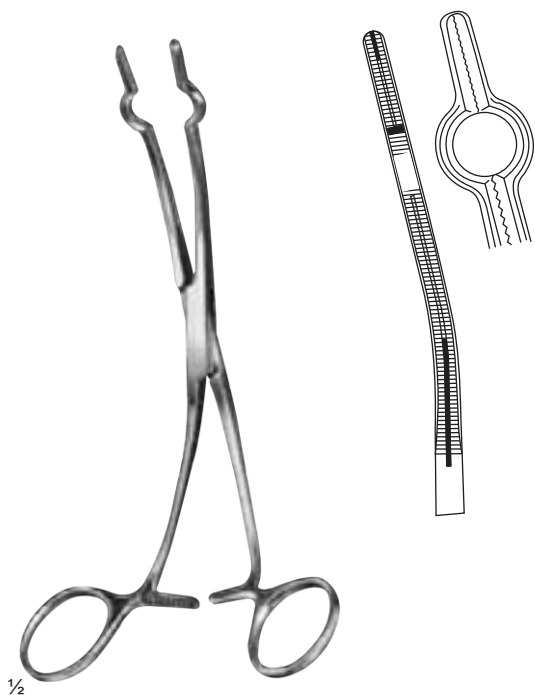

Cooley
26-328-01 - 26-328-07

Charriere (French)	Length		
	cm	in	
24	16	6¼"	26-328-01
26	16	6¼"	26-328-02
28	20	8"	26-328-03
30	20	8"	26-328-04
32	20	8"	26-328-05
36	20	8"	26-328-07

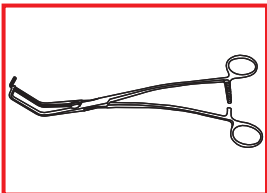

Vascular Forceps

Gefäßpinzetten
Pinzas de disección vascular

Pinces à dissection vasculaires
Pinze per dissezione vascolari

1.5 mm

ATRAUMA

2.0 mm

2.7 mm

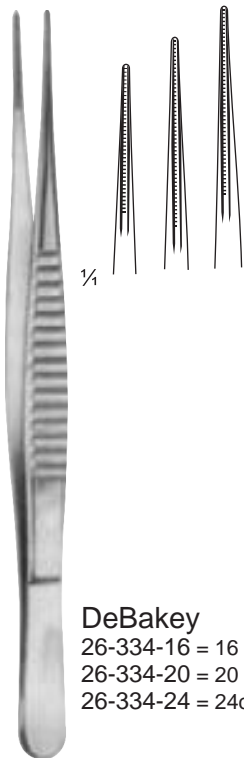

DeBakey
26-334-16 = 16 cm / 6¼"
26-334-20 = 20 cm / 8"
26-334-24 = 24cm / 9¼"

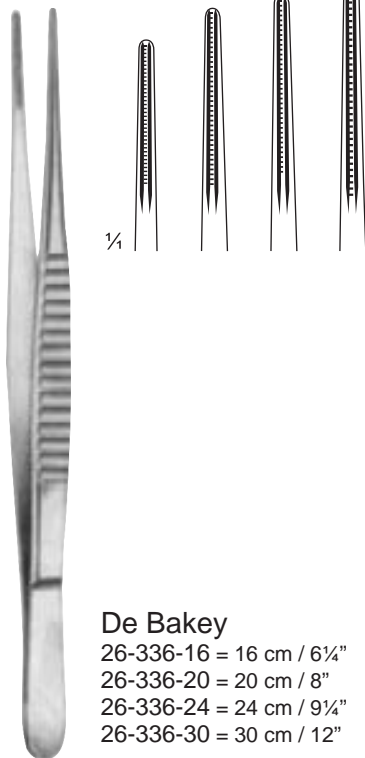

DeBakey
26-336-16 = 16 cm / 6¼"
26-336-20 = 20 cm / 8"
26-336-24 = 24 cm / 9¼"
26-336-30 = 30 cm / 12"

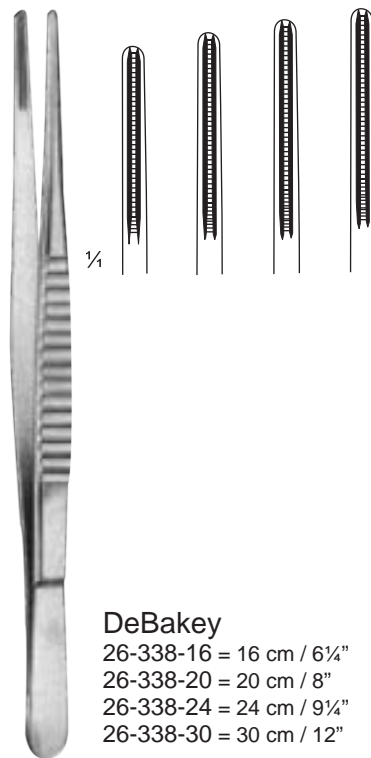

DeBakey
26-338-16 = 16 cm / 6¼"
26-338-20 = 20 cm / 8"
26-338-24 = 24 cm / 9¼"
26-338-30 = 30 cm / 12"

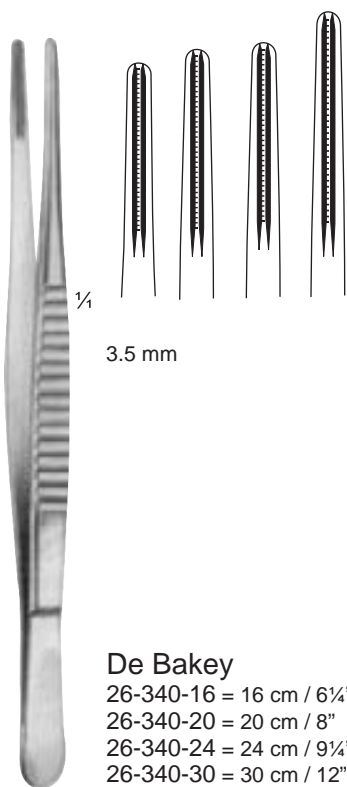

DeBakey
26-340-16 = 16 cm / 6¼"
26-340-20 = 20 cm / 8"
26-340-24 = 24 cm / 9¼"
26-340-30 = 30 cm / 12"



Cooley
26-342-16 = 16 cm / 6¼"
26-342-20 = 20 cm / 8"

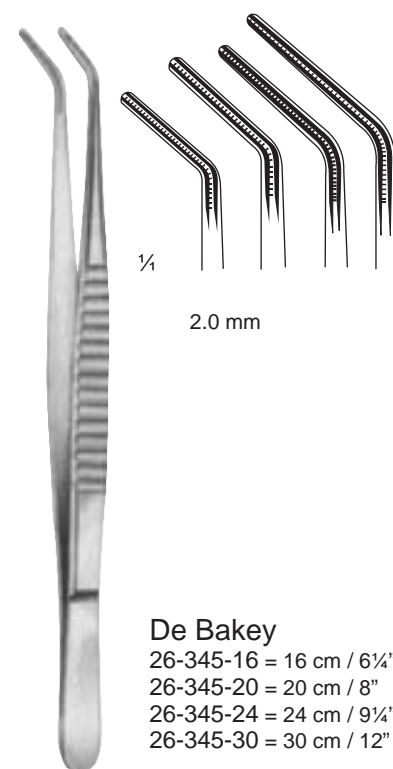

DeBakey
26-345-16 = 16 cm / 6¼"
26-345-20 = 20 cm / 8"
26-345-24 = 24 cm / 9¼"
26-345-30 = 30 cm / 12"

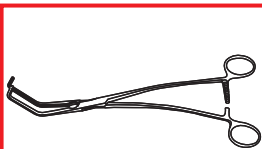

Coarctation Clamps

Coarctationsklemmen
Pinzas para coarctación

Pinces-clamps pour coarctation
Pinze per coartazione



De Bakey
1:2 rows of teeth

ATRAUMA

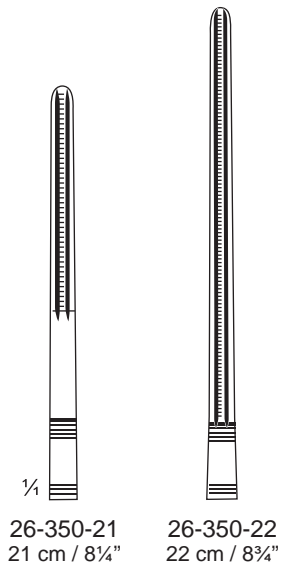
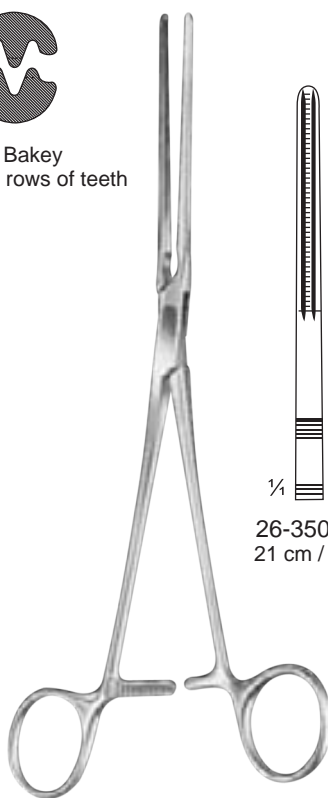

26-350-21 21 cm / 8¼"
26-350-22 22 cm / 8¾"

Potts
26-350-21 - 26-350-22

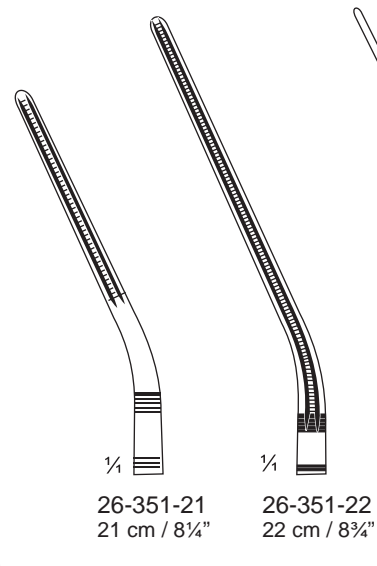

26-351-21 21 cm / 8¼"
26-351-22 22 cm / 8¾"

Potts
26-351-21 - 26-351-22

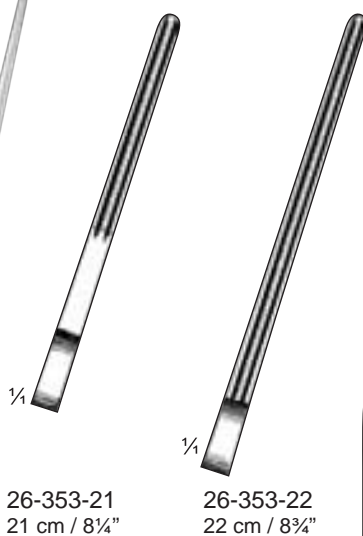
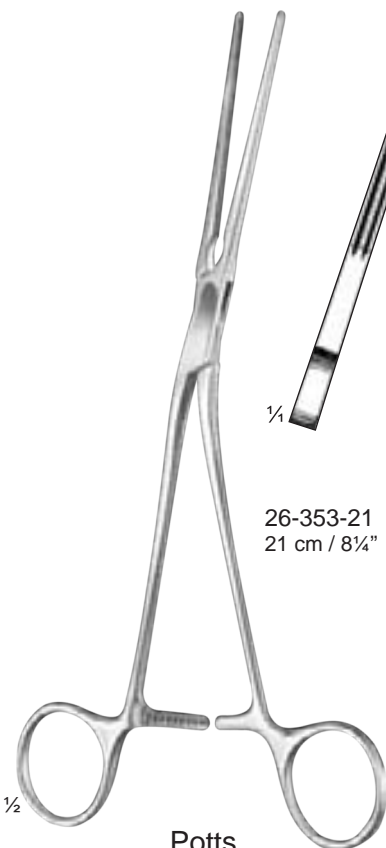

26-353-21 21 cm / 8¼"
26-353-22 22 cm / 8¾"

Potts
26-353-21 - 26-353-22

Anastomosis Clamps, Ligature Forceps

Anastomosenklemmen, Ligaturklemmen
Pinzas para anastomosis, Pinzas para ligaduras

Pinces-clamps à anastomose, pinces à ligatures
Pinze per anastomosi, Pinze per legature

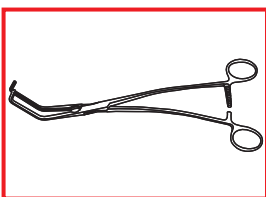

De Bakey
1:2 rows of teeth

ATRAUMA

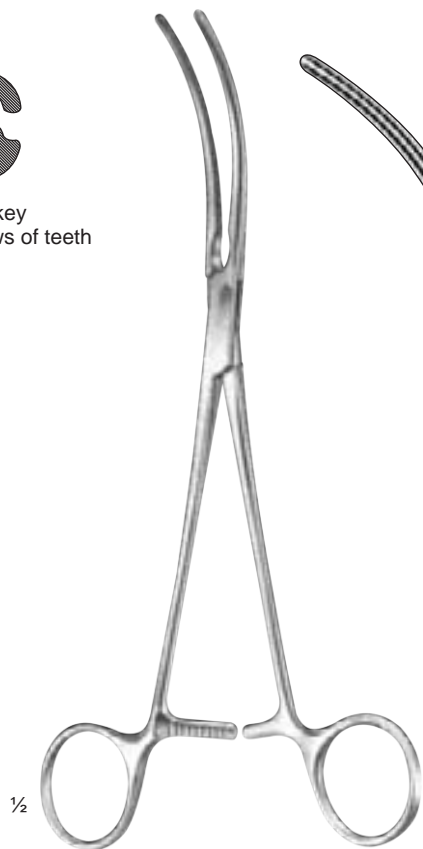

Potts
26-359-22
22 cm / 8 3/4"

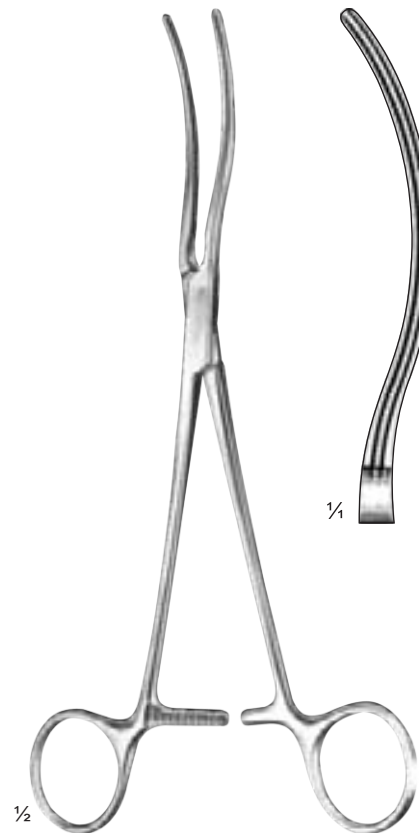

Potts
26-361-22
22 cm / 8 3/4"



DeBakey
26-362-19 - 26-362-23



26-362-19
19 cm / 7 1/2"

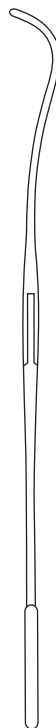

26-362-23
23 cm / 9"

Peripheral Vascular Clamps

Peripheral-Gefäßklemmen
Pinzas para vasos periféricos

Pinces-clamps vasculaires périphériques
Pinze vascolari periferali

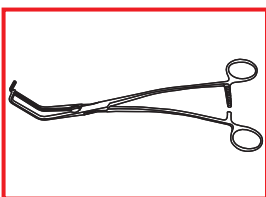

De Bakey
1:2 rows of teeth

ATRAUMA



DeBakey
26-369-16
16 cm / 6¼"

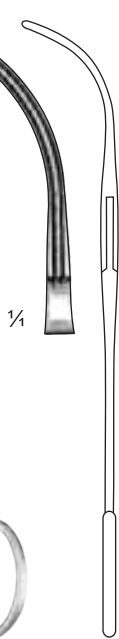

¼

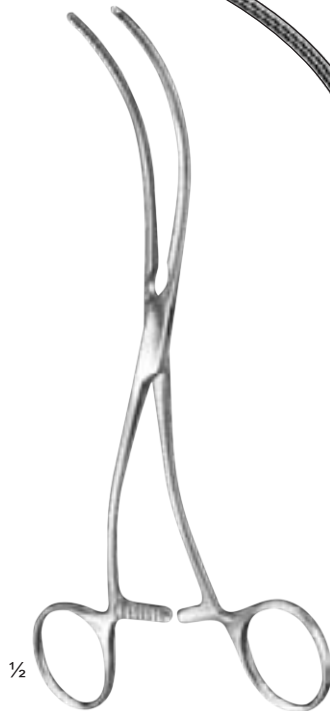

DeBakey
26-371-19 - 26-371-20

½

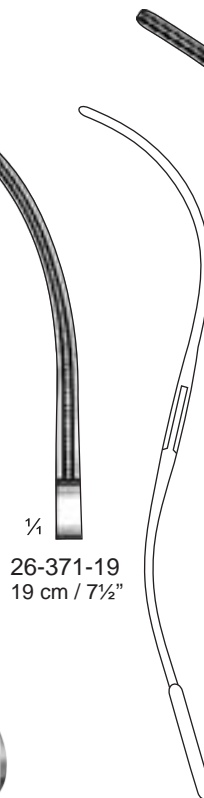

¼
26-371-19
19 cm / 7½"

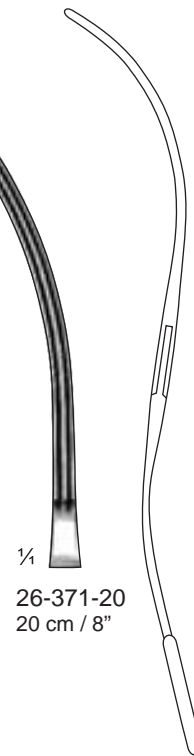
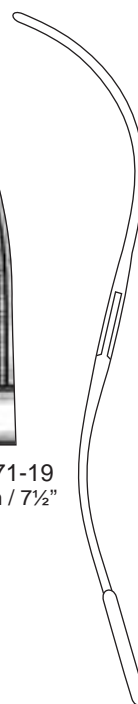

¼
26-371-20
20 cm / 8"



Leland-Jones
26-373-18 - 26-373-20

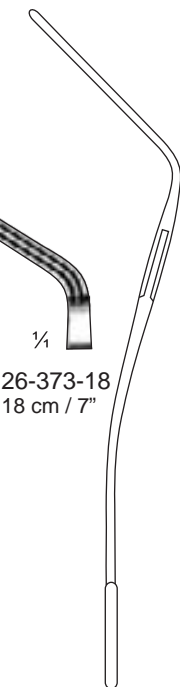

¼
26-373-18
18 cm / 7"

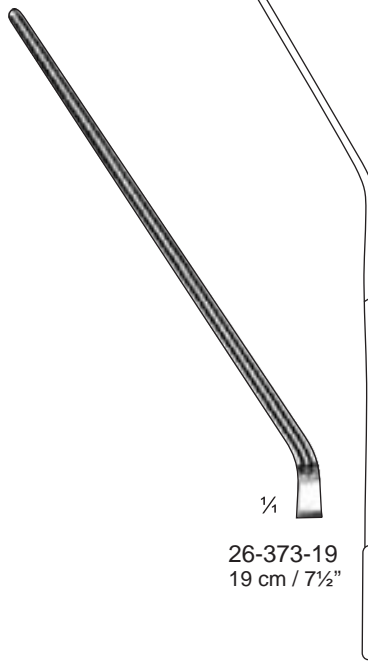

¼
26-373-19
19 cm / 7½"

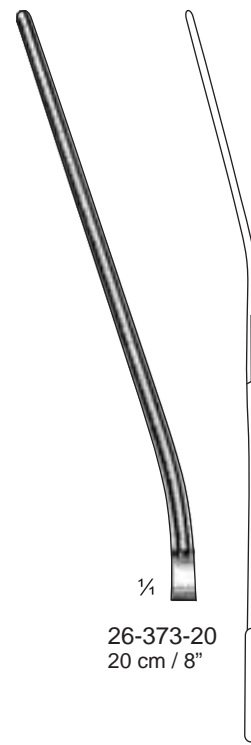

¼
26-373-20
20 cm / 8"

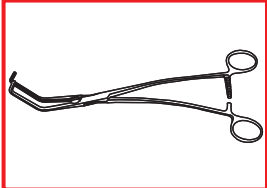

Multi Purpose Vascular Clamps

Mehrzweck-Gefäßklemmen
Pinzas vasculares de usos múltiples

Pinces vasculaires universelles
Pinze vascolari universali



De Bakey
1:2 rows of teeth

ATRAUMA



26-378-15
15 cm / 6"

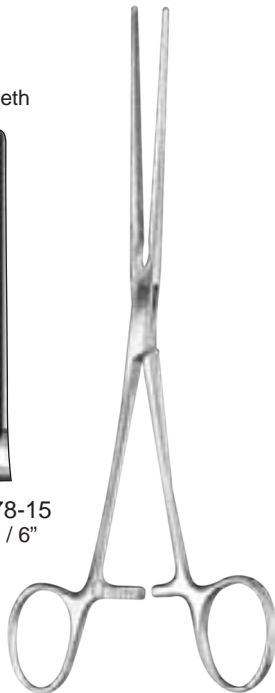

Bainbridge
26-378-15 - 26-378-18



26-378-18
18 cm / 7"



Bainbridge
26-379-15 - 26-379-18



26-379-15
15 cm / 6"



26-379-18
18 cm / 7"

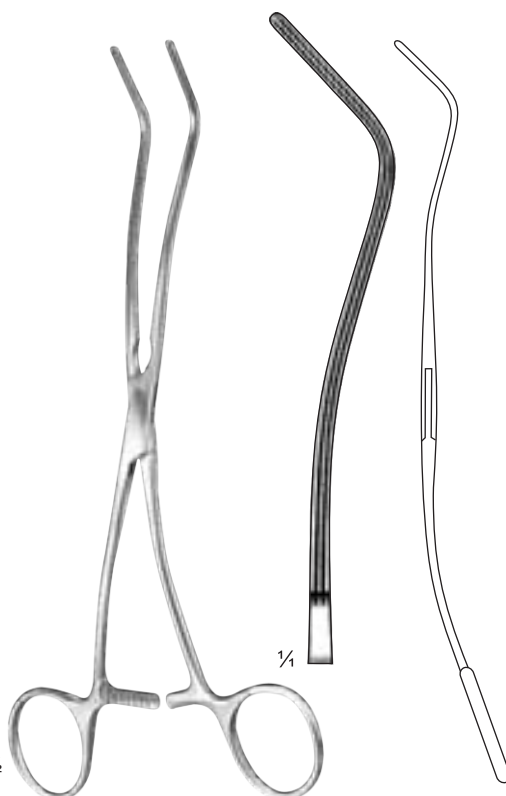

DeBakey
26-380-20
20 cm / 8"

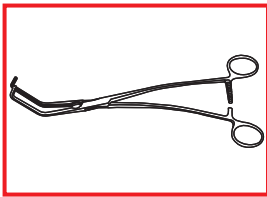

Aortic Aneurysm Clamps

Aorta-Aneurysmaklemmen
Pinzas para aneurisma de aórtica

Pinces-clamps pour anévrisme de l' aorte
Pinze per aneurisma della aorta



De Bakey
1:2 rows of teeth

ATRAUMA

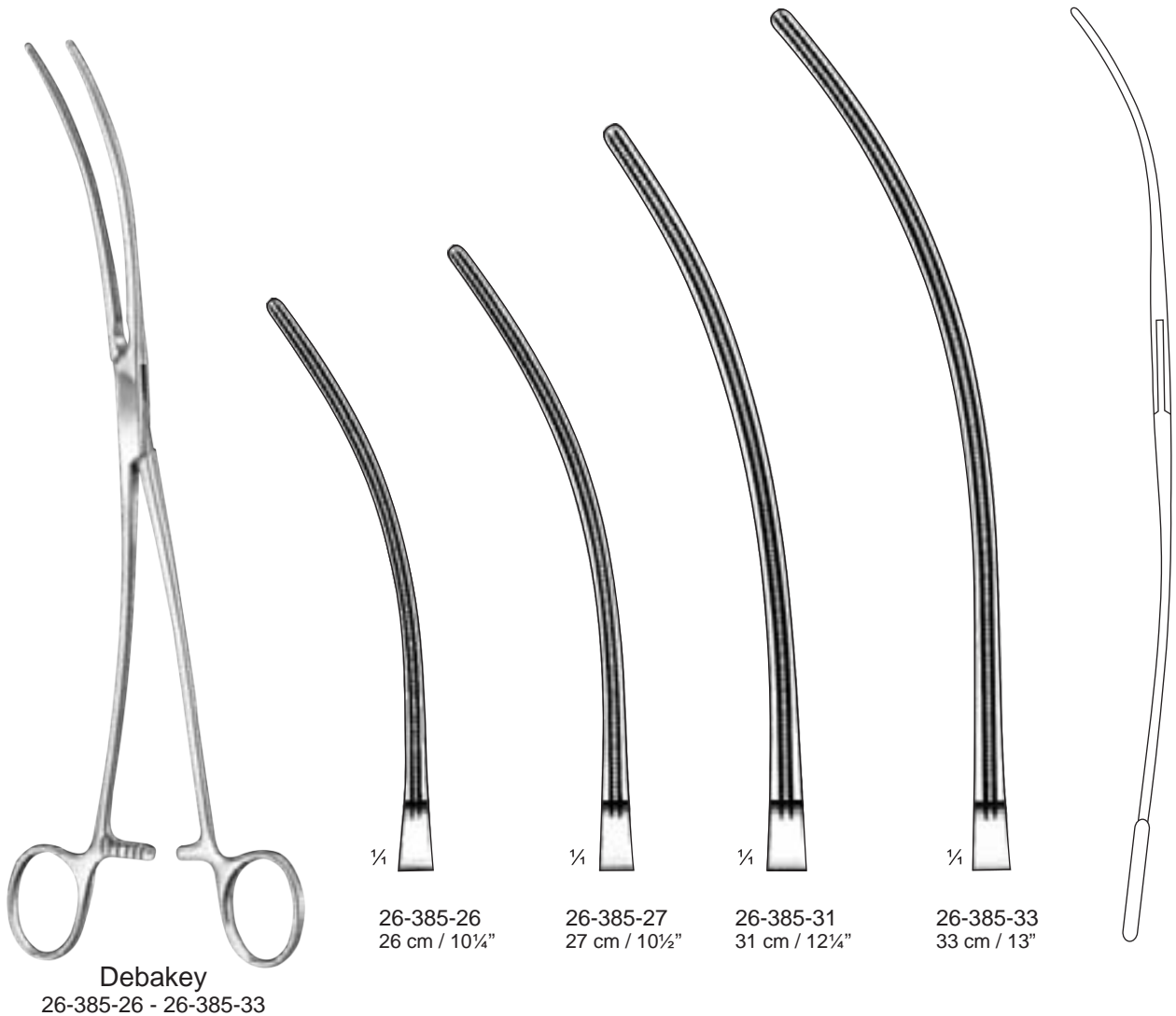

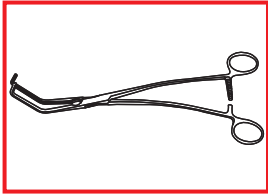

Aortic Aneurysm Clamps

Aorta-Aneurysmaklemmen
Pinzas para aneurisma de aórtica

Pinces-clamps pour anévrisme de l' aorte
Pinze per aneurisma della aorta



De Bakey
1:2 rows of teeth

ATRAUMA



DeBakey
26-390-28
28 cm / 11"

DeBakey
26-391-30
30 cm / 11 3/4"

Aortic Clamps, Ligature Forceps

Aortaklemmen, Ligaturklemmen
Pinzas aórticas, Pinzas para ligaduras

Pince-clamps pour aorte, Pincés à ligatures
Pinze per aorta, Pinze per legature

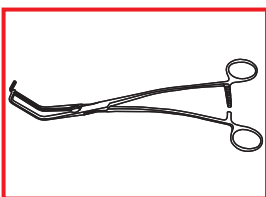

De Bakey
1:2 rows of teeth

ATRAUMA

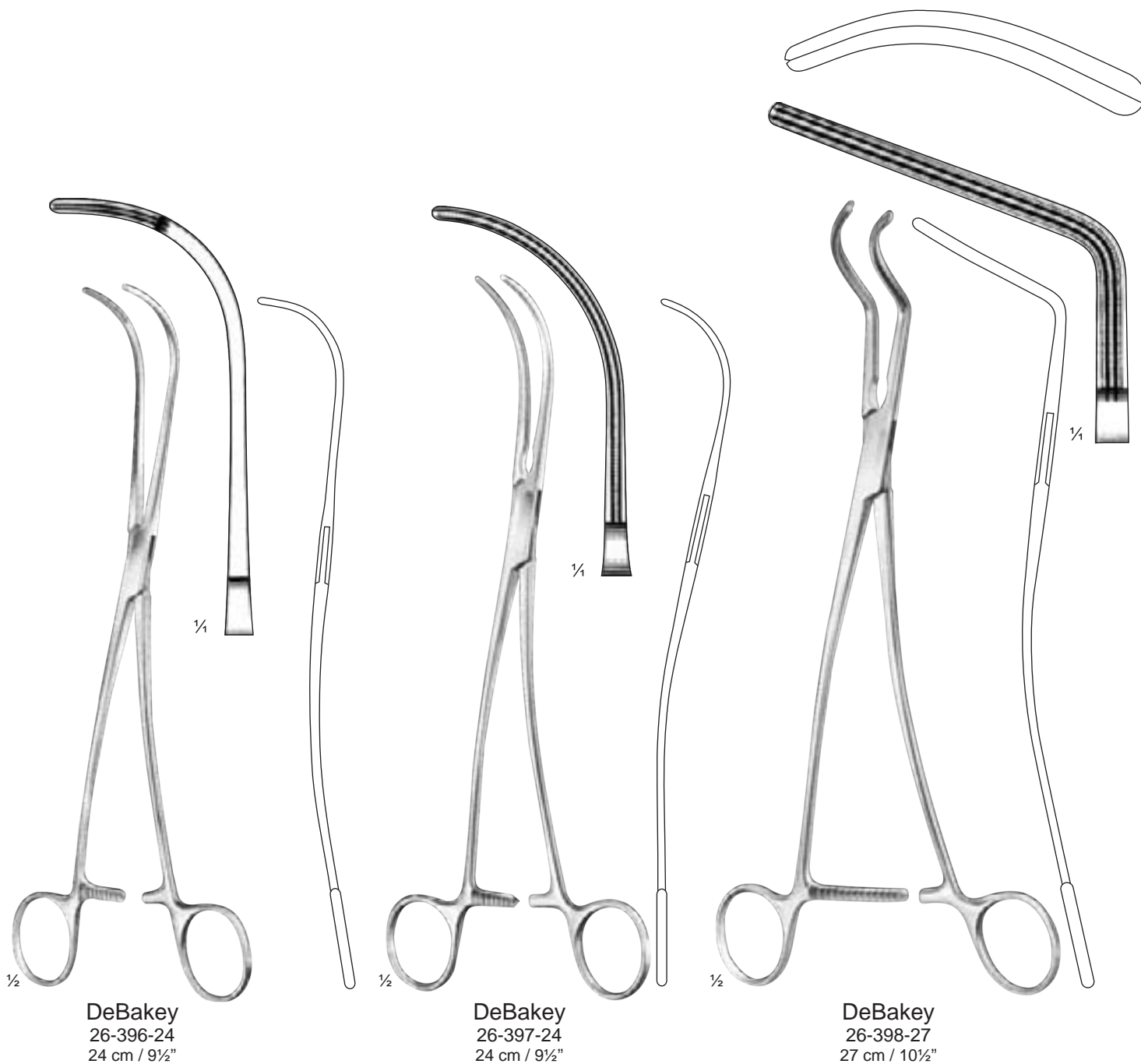

DeBakey
26-396-24
24 cm / 9½"

DeBakey
26-397-24
24 cm / 9½"

DeBakey
26-398-27
27 cm / 10½"

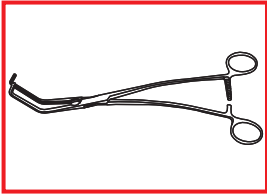

Aortic Clamps, Ligature Forceps

Aortaklemmen, Ligaturklemmen
Pinzas aórticas, Pinzas para ligaduras

Pince-clamps pour aorte, Pincés à ligatures
Pinze per aorta, Pinze per legature



De Bakey
1:2 rows of teeth

ATRAUMA



1/2

DeBakey
26-403-25
25 cm / 10"



1/2

DeBakey
26-403-26
26 cm / 10 1/4"

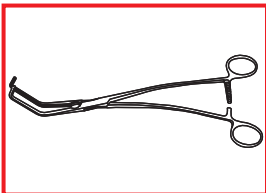

Aortic Clamps

Aortaklemmen
Pinzas aórticas

Pinces-clamps pour aorte
Pinze per aorta



De Bakey
1:2 rows of teeth

ATRAUMA



¼

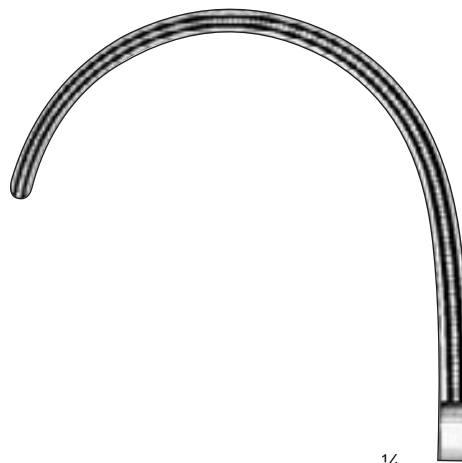

¼



½

Weber
26-408-01
26 cm / 10¼"
left



½

Weber
26-408-02
26 cm / 10¼"
right

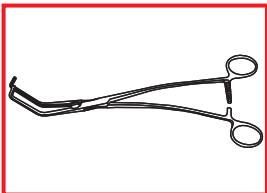

Tangential Occlusion Clamps

Tangentialklemmen
Pinzas para oclusión tangencial

Pinces-clamps pour occlusion tangentielle
Pinze per occlusione tangenziale



De Bakey
1:2 rows of teeth

ATRAUMA



Satinsky
26-415-20 - 26-415-27

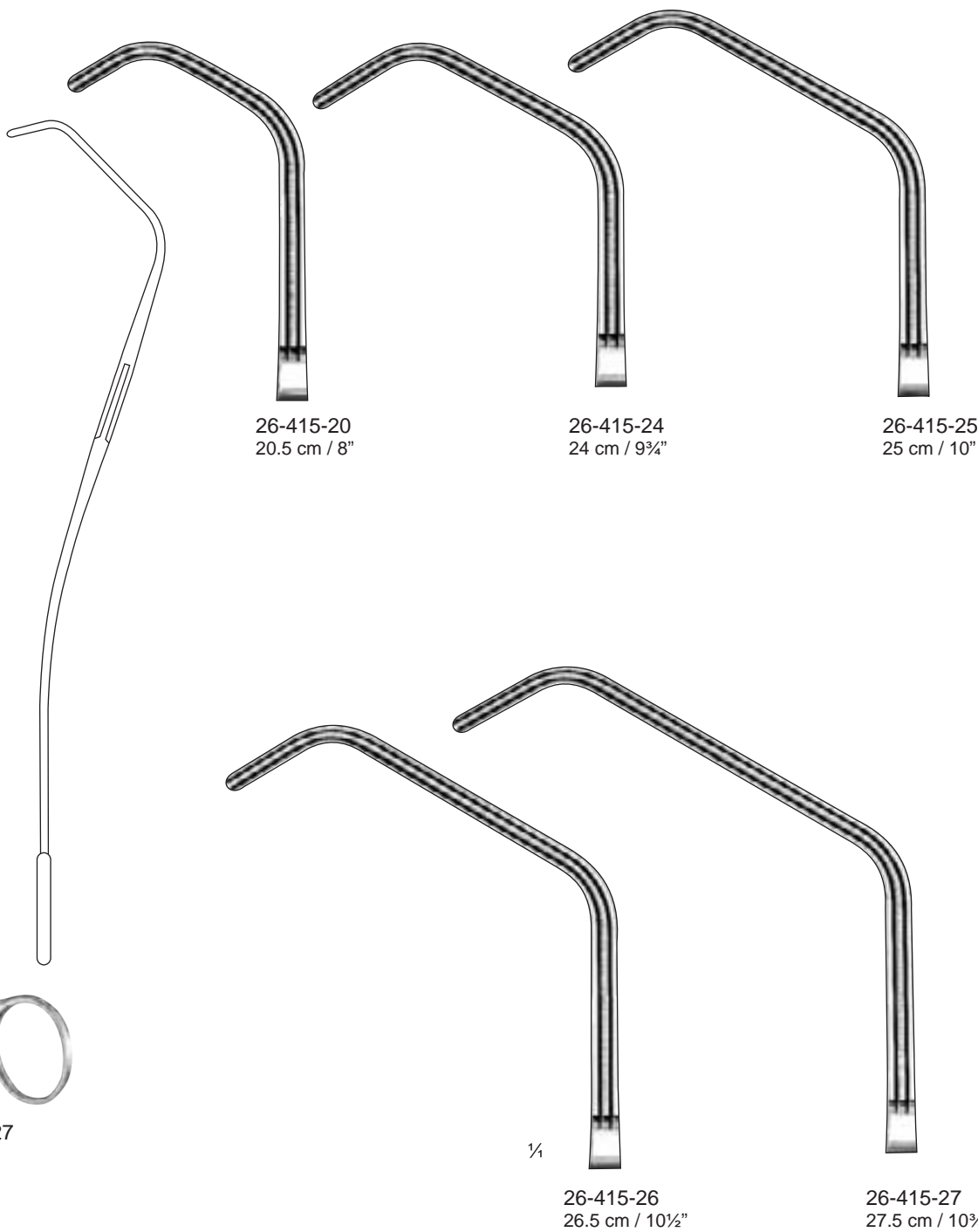

26-415-20
20.5 cm / 8"

26-415-24
24 cm / 9³/₄"

26-415-25
25 cm / 10"

26-415-26
26.5 cm / 10¹/₂"

26-415-27
27.5 cm / 10³/₄"

Auricle Clamps

Aurikelklemmen
Pinzas para aurícula

Pinces auriculaires
Pinze ventricolari



De Bakey
1:2 rows of teeth

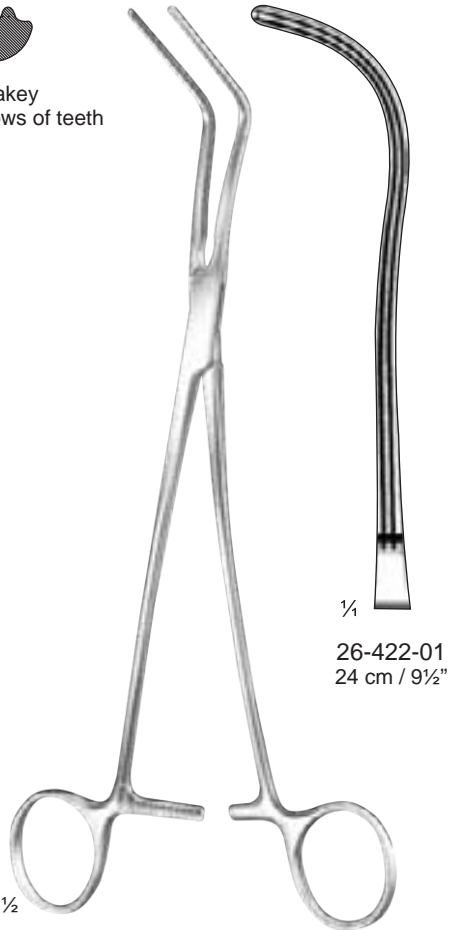

Harken
26-422-01 - 26-422-04

ATRAUMA

¼
26-422-01
24 cm / 9½"

¼
26-422-02
24 cm / 9½"

¼
26-422-03
24 cm / 9½"

¼
26-422-04
24 cm / 9½"

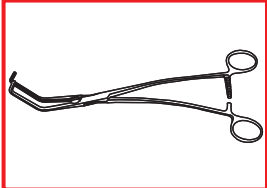

Bronchus Clamps

Bronchusklemmen
Pinzas bronquiales

Pince-clamps à bronches
Pinze per bronchi



De Bakey
1:2 rows of teeth

ATRAUMA

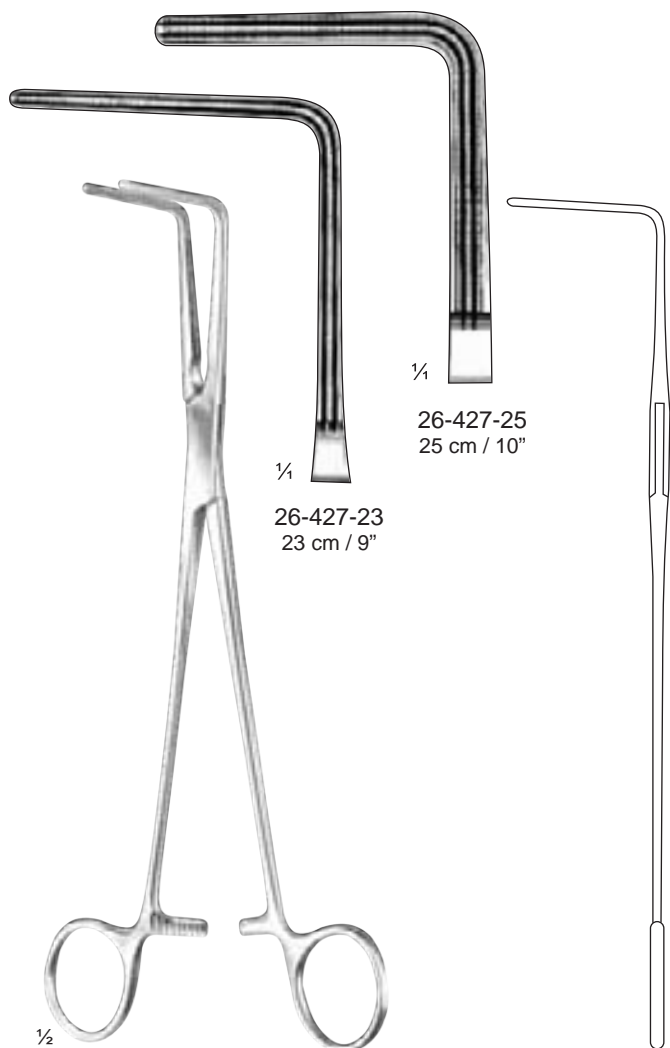

1/4
26-427-23
23 cm / 9"

1/4
26-427-25
25 cm / 10"

1/2

Lees
26-427-23 - 26-427-25

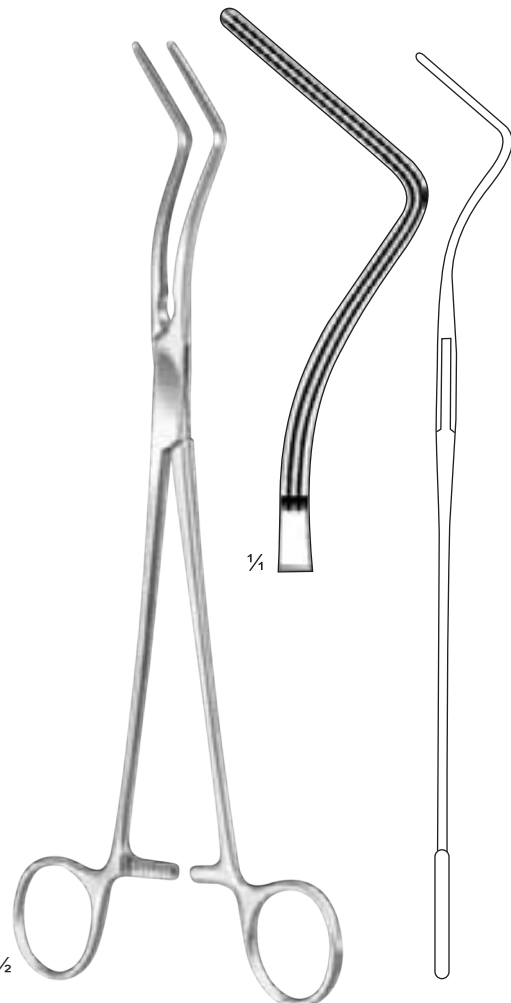

1/4

1/2

Lees
26-429-25
25 cm / 10"

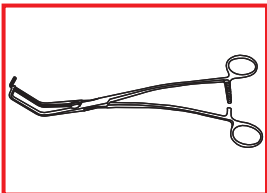

Anastomosis Clamps

Anastomosenklemmen
Pinzas para anastomosis

Pinces-clamps pour anastomose
Pinze per anastomosi



De Bakey
1:2 rows of teeth

ATRAUMA



Lambert-Kay
26-434-21 - 26-434-22



$\frac{1}{4}$
26-434-21
21 cm / 8 $\frac{1}{4}$ "



26-434-22
22 cm / 8 $\frac{1}{2}$ "

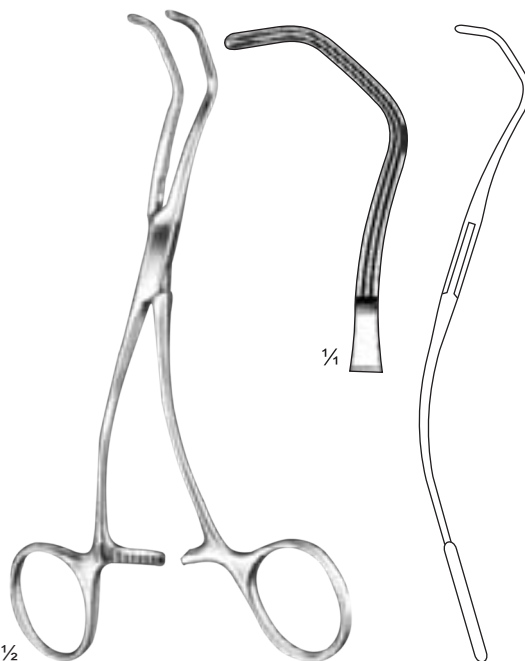
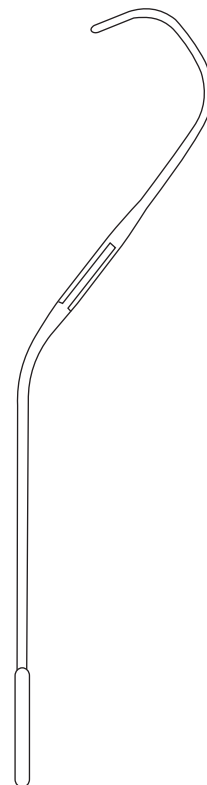

$\frac{1}{2}$
DeBakey
26-435-17
17 cm / 6 $\frac{3}{4}$ "

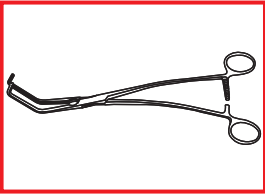

Aortic Clamps

Aortaklemmen
Pinzas aórticas

Pinces-clamps pour aorte
Pinze per aorta



De Bakey
1:2 rows of teeth

ATRAUMA

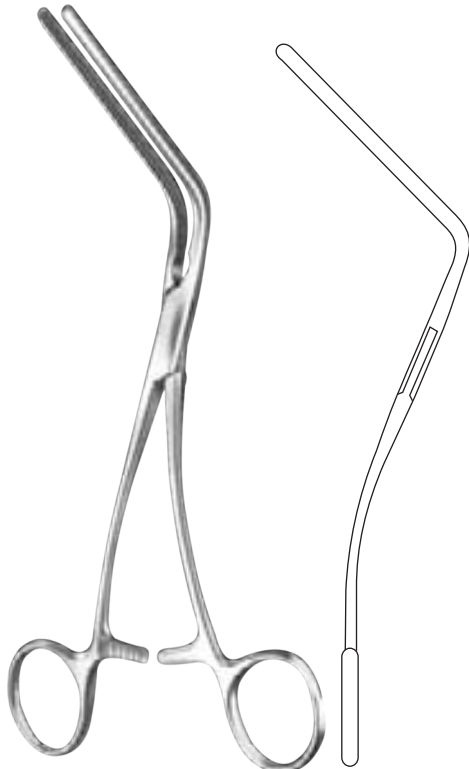

Morris-De Bakey
26-440-18 - 26-440-25



26-440-18
18 cm / 7"

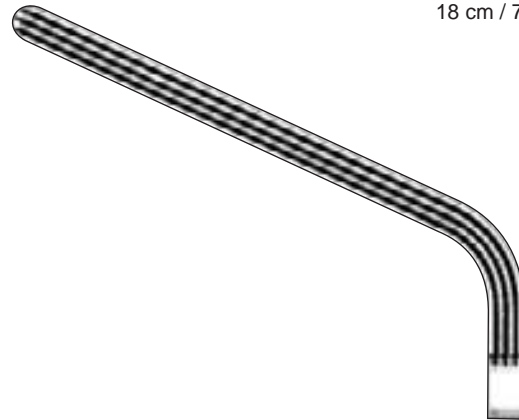

26-440-20
20 cm / 8"

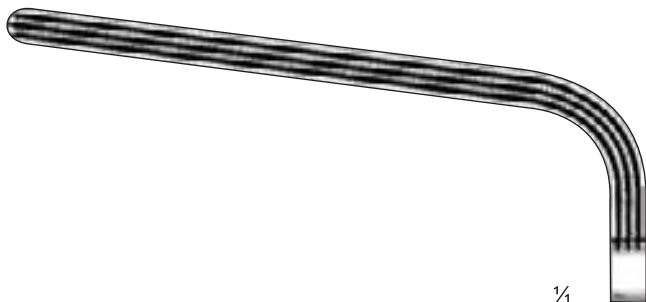

1/4
26-440-23
23 cm / 9"

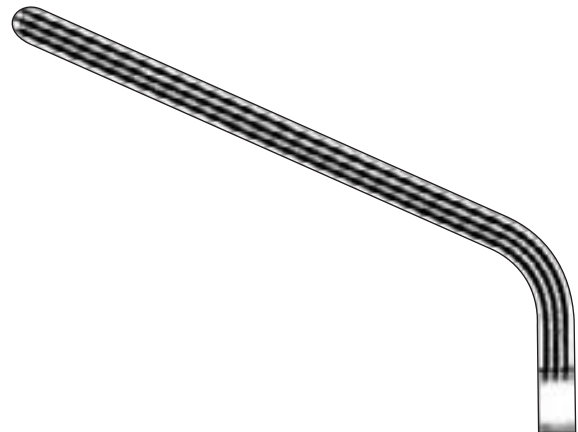

26-440-25
25 cm / 10"

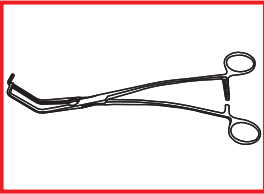

Aneurysm Clamps

Aneurysmaklemmen
Pinzas para aneurisma

Pinces-clamps pour anévrisme
Pinze per aneurisma



De Bakey
1:2 rows of teeth

ATRAUMA



DeBakey-Bahnson
26-449-23 - 26-449-25

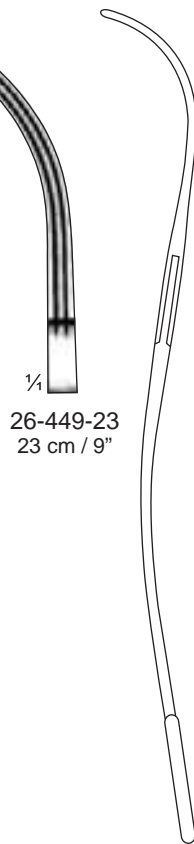

1/4
26-449-23
23 cm / 9"

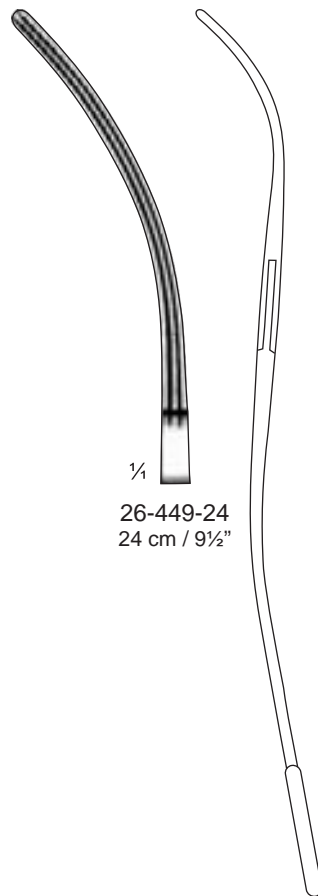

1/4
26-449-24
24 cm / 9½"

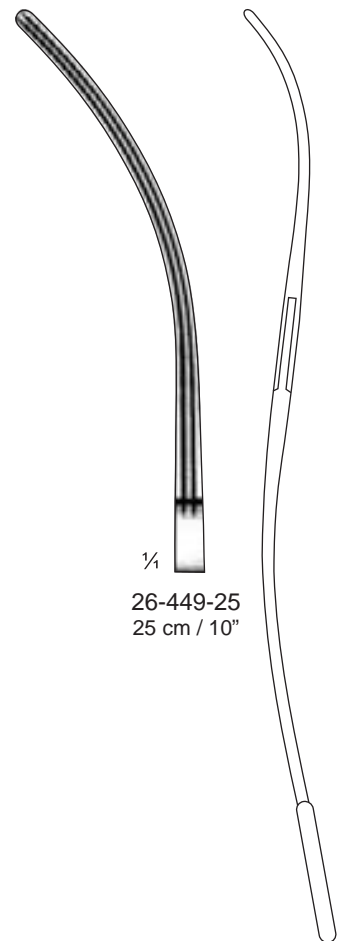

1/4
26-449-25
25 cm / 10"

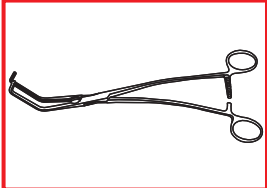

Multi Purpose Vascular Clamps

Mehrzweck-Gefäßklemmen
Pinzas vasculares de usos múltiples

Pinces vasculaires universelles
Pinze vascolari universali



De Bakey
1:2 rows of teeth

ATRAUMA



Potts
26-454-21 - 26-454-31



$\frac{1}{4}$
26-454-21
21.5 cm / 8½"



$\frac{1}{4}$
26-454-23
23 cm / 9"



$\frac{1}{4}$
26-454-27
27 cm / 10 ½"



$\frac{1}{4}$
26-454-31
31.5 cm / 12½"



Potts
26-455-21 - 26-455-31



$\frac{1}{4}$
26-455-21
21.5 cm / 8½"



$\frac{1}{4}$
26-455-23
23 cm / 9"



$\frac{1}{4}$
26-455-27
27 cm / 10½"



$\frac{1}{4}$
26-455-31
31 cm / 12½"



Multi Purpose Vascular Clamps

Mehrzweck-Gefäßklemmen
Pinzas vasculares de usos múltiples

Pinces vasculaires universelles
Pinze vascolari universali



De Bakey
1:2 rows of teeth

ATRAUMA



Debakey
26-461-20 - 26-461-29

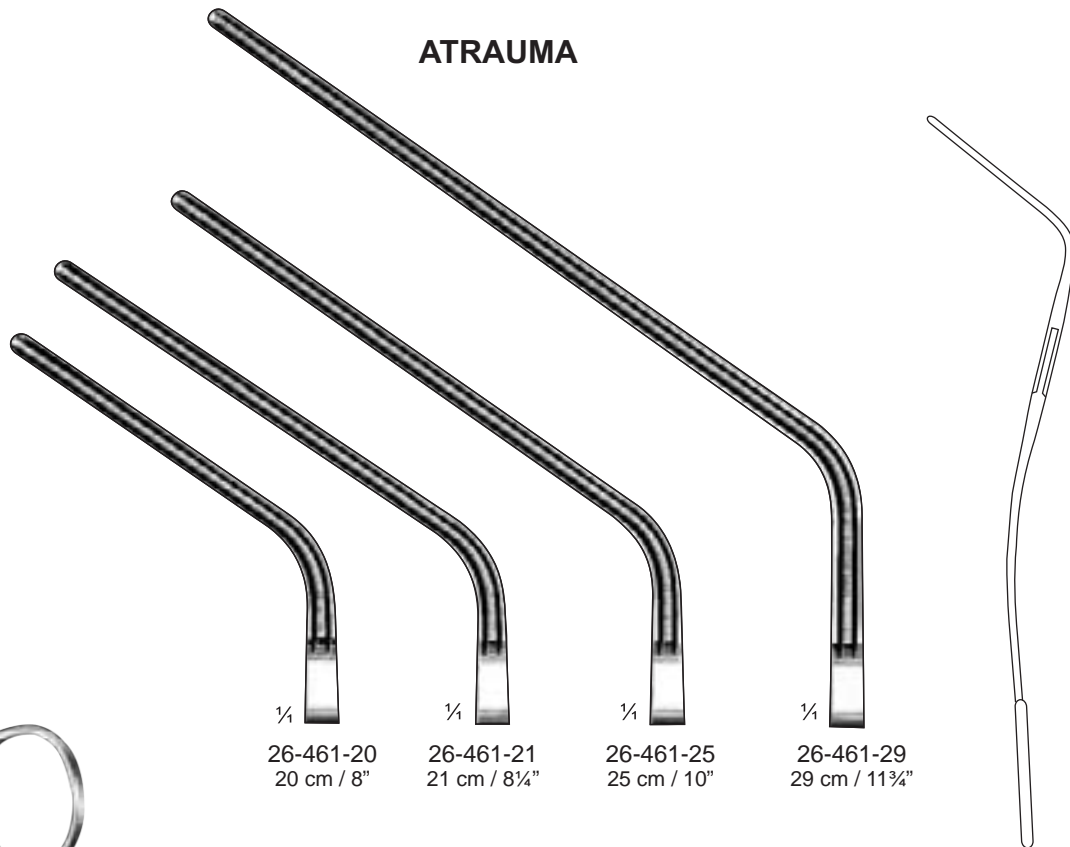

¼	¼	¼	¼
26-461-20 20 cm / 8"	26-461-21 21 cm / 8¼"	26-461-25 25 cm / 10"	26-461-29 29 cm / 11¼"



DeBakey
26-462-18 - 26-462-27

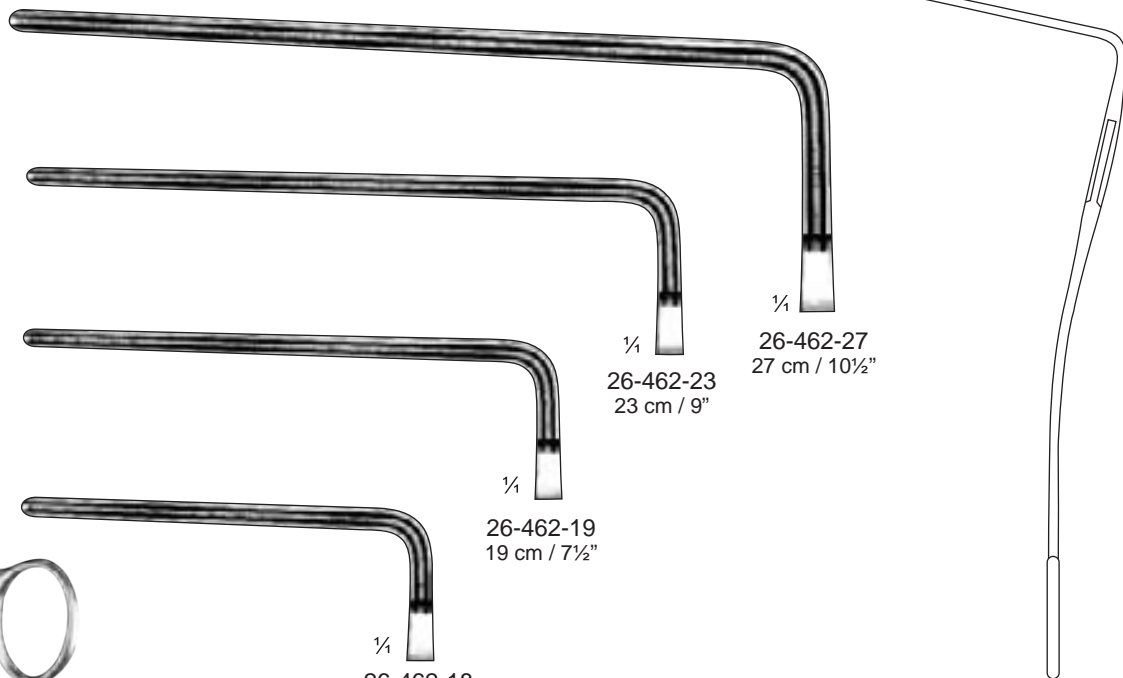

¼	¼
26-462-18 18 cm / 7"	26-462-23 23 cm / 9"
	26-462-27 27 cm / 10½"

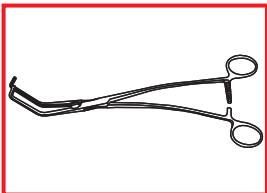

Haemostatic Forceps

Arterienklemmen Pincas hémostatiques
 Pinzas hemostáticas Pinze emostatiche



De Bakey
 1:2 rows of teeth



De Bakey-Pean
 26-468-14 - 26-468-20

ATRAUMA

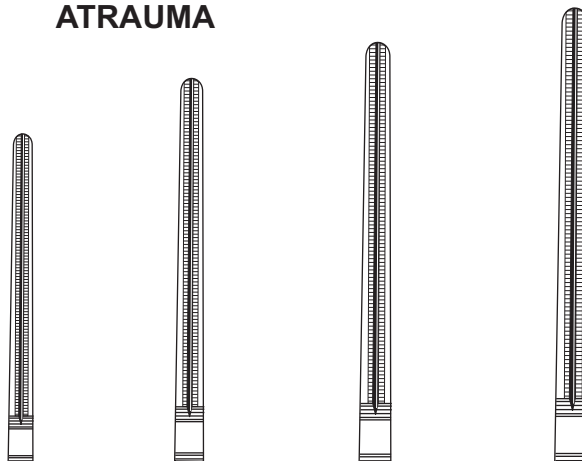

26-468-14 14 cm / 5½"	26-468-16 16 cm / 6¼"	26-468-18 18 cm / 7"	26-468-20 20 cm / 8"
--------------------------	--------------------------	-------------------------	-------------------------



De Bakey-Pean
 26-469-14 - 26-469-20

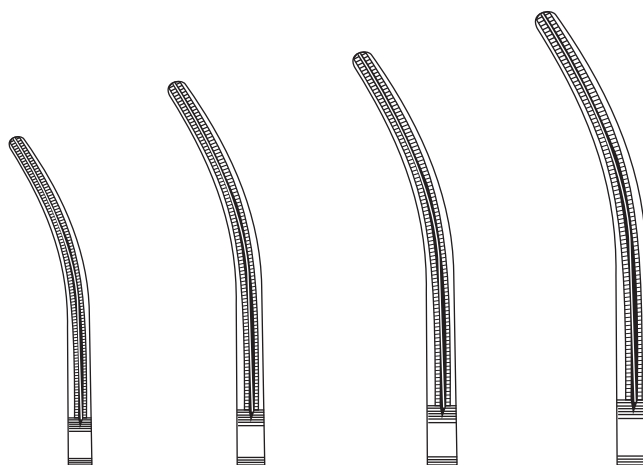

26-469-14 14 cm / 5½"	26-469-16 16 cm / 6¼"	26-469-18 18 cm / 7"	26-469-20 20 cm / 8"
--------------------------	--------------------------	-------------------------	-------------------------

Multi Purpose Vascular Clamps

Mehrzweck-Gefäßklemmen
Pinzas vasculares de usos múltiples

Pinces vasculaires universelles
Pinze vascolari universali

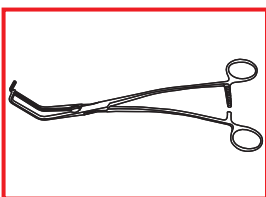

De Bakey
1:2 rows of teeth

ATRAUMA

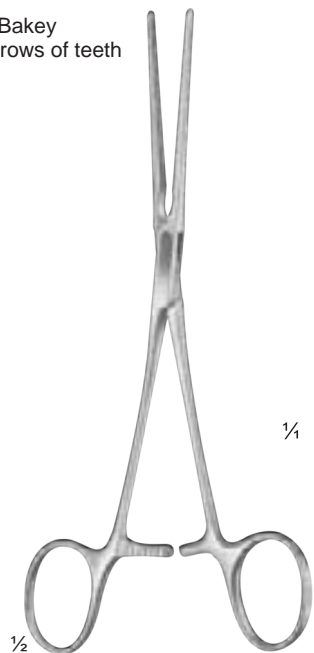

1/2
DeBakey
26-473-17
17 cm / 6 3/4"

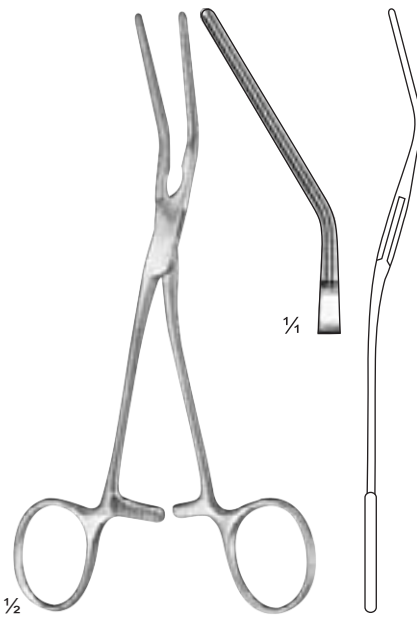

1/2
DeBakey
26-475-16
16 cm / 6 1/4"

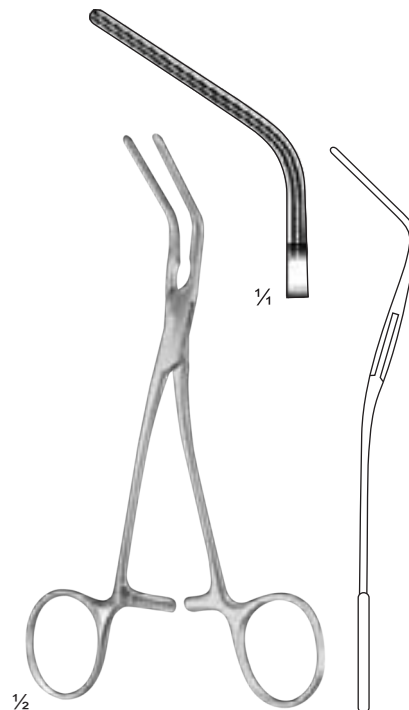

1/2
DeBakey
26-477-15
15 cm / 6"

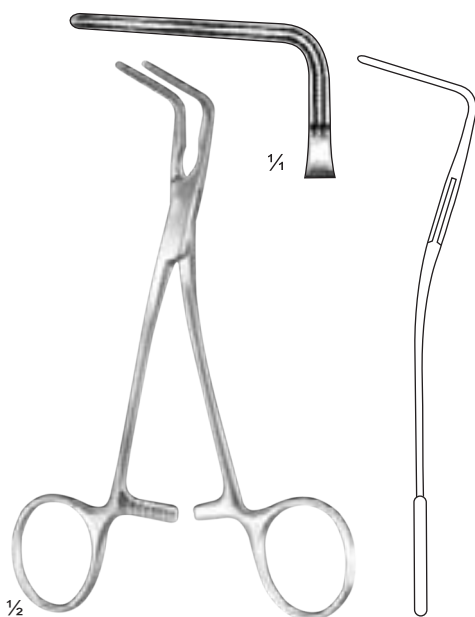

1/2
DeBakey
26-479-15
15 cm / 6"

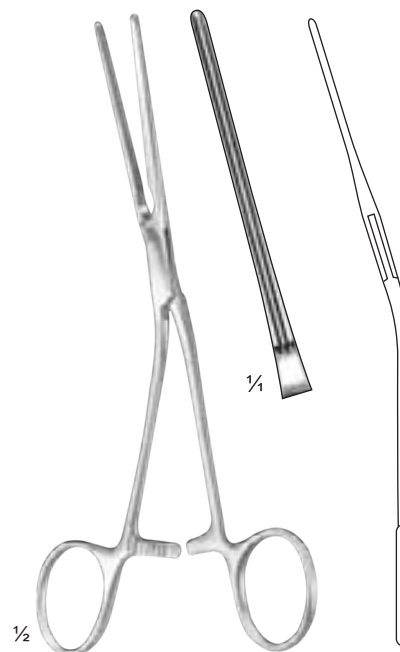

1/2
DeBakey
26-481-17
17 cm / 6 3/4"



Anastomosis Clamps, Multi Purpose Vascular Clamps

Anastomosenklemmen, Mehrzweck-Gefäßklemmen
 Pinzas para anastomosis ,Pinzas vasculares de usos múltiples

Pinces-clamps pour anastomose, Pinces vasculaires universelles
 Pinze per anastomosi, Pinze vascolari universali



De Bakey
 1:2 rows of teeth

ATRAUMA

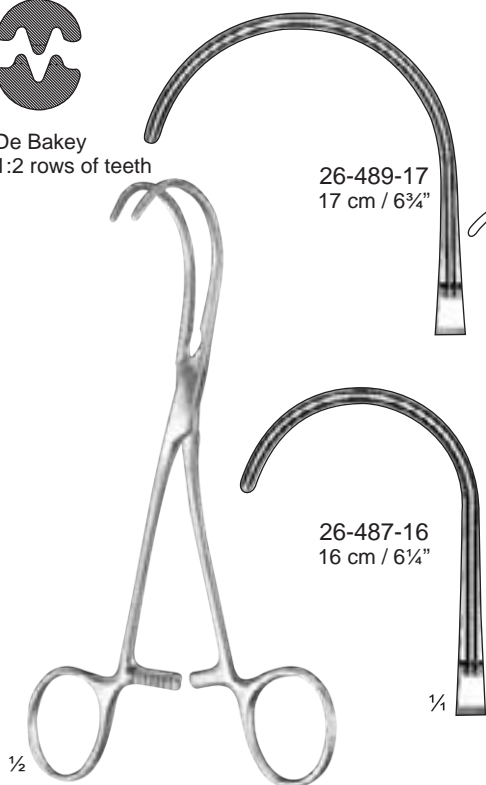

Debakey
 26-487-16 - 26-489-17

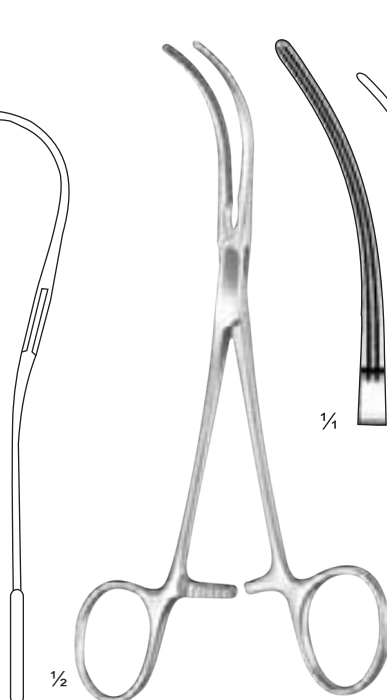

Glover
 26-491-17
 17 cm / 6 3/4"

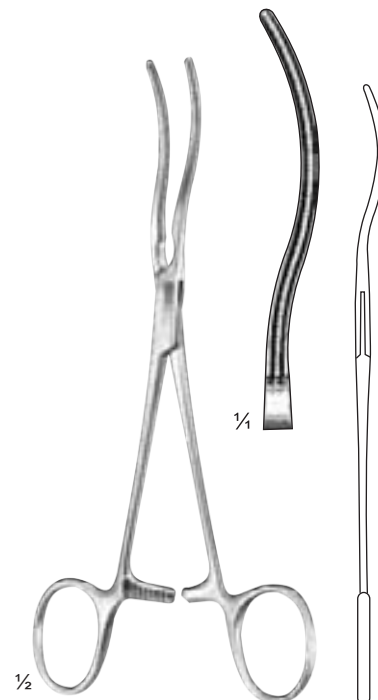

26-493-17
 17 cm / 6 3/4"

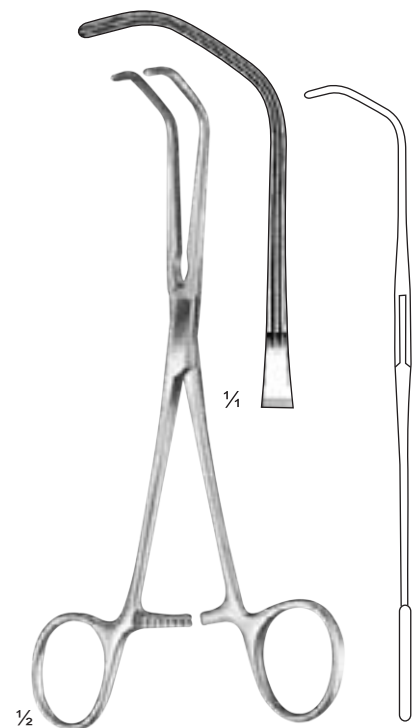

Beck
 26-495-17
 17 cm / 6 3/4"

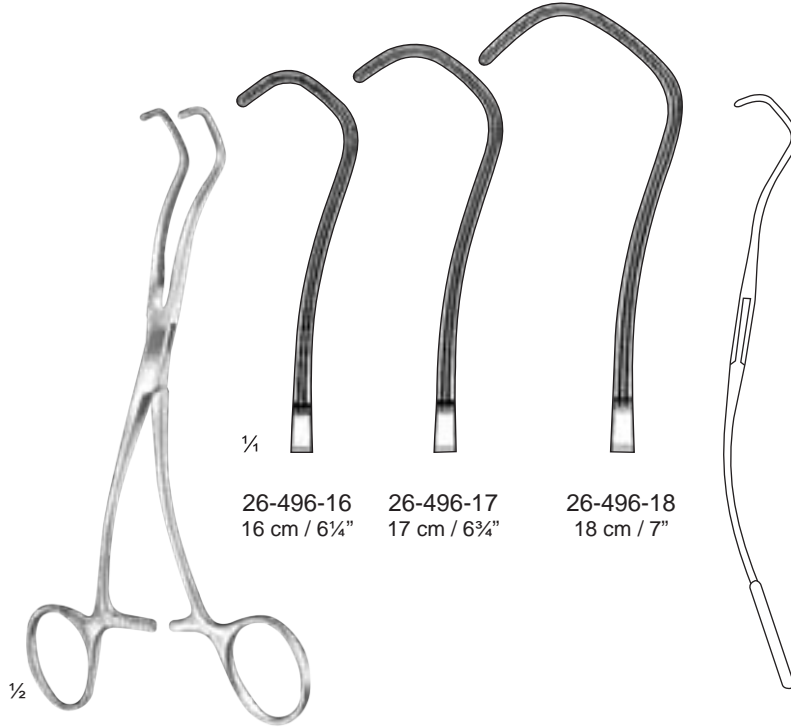

Derra
 26-496-16 - 26-496-18

Pediatric Vascular Clamps

Kinder-Gefäßklemmen
Pinzas vasculares pediátricas

Pinces vasculaires pédiatriques
Pinze vascolari pediatriche

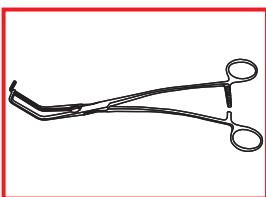

DeBakey
1:2 rows of teeth

ATRAUMA

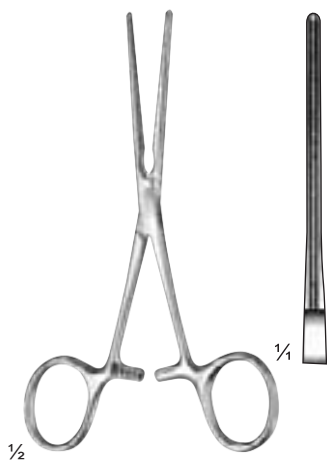

DeBakey
26-502-01
12 cm / 4 3/4"

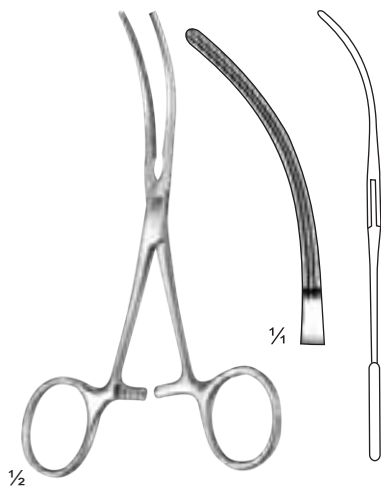

DeBakey
26-502-02
11 cm / 4 1/4"

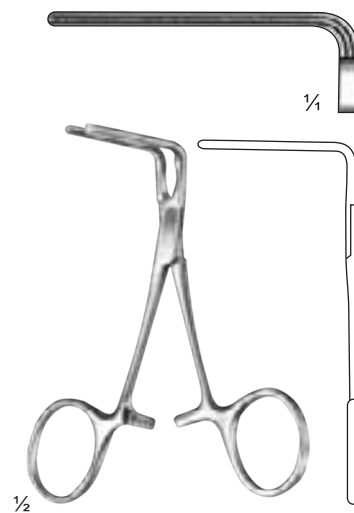

DeBakey
26-502-03
10 cm / 4"

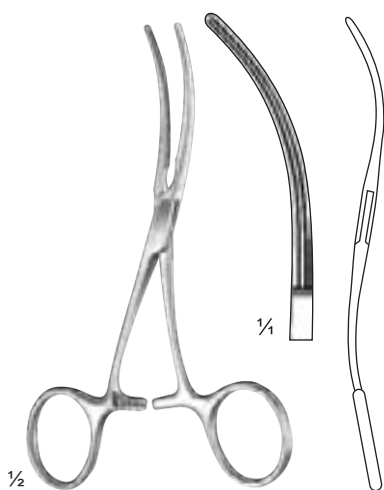

DeBakey
26-502-04
12 cm / 4 3/4"

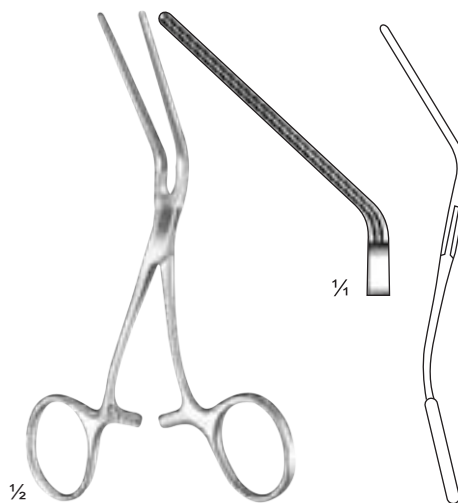

DeBakey
26-502-05
13 cm / 5 1/4"



Pediatric Vascular Clamps

Kinder-Gefäßklemmen
Pinzas vasculares pediátricas

Pinces vasculaires pédiatriques
Pinze vascolari pediatriche

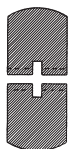

Cooley
2:2 rows of teeth

ATRAUMA



Cooley
26-508-01 - 26-508-02
14 cm / 5½"

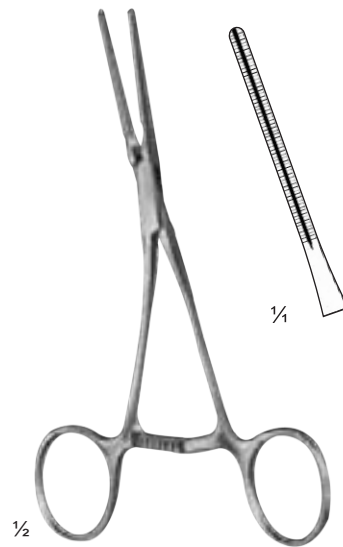
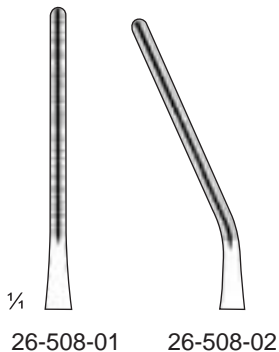

Cooley
26-508-03
14 cm / 5½"

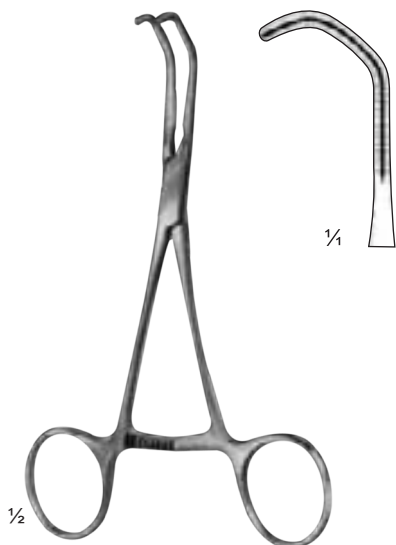

Cooley
26-508-04
14 cm / 5½"

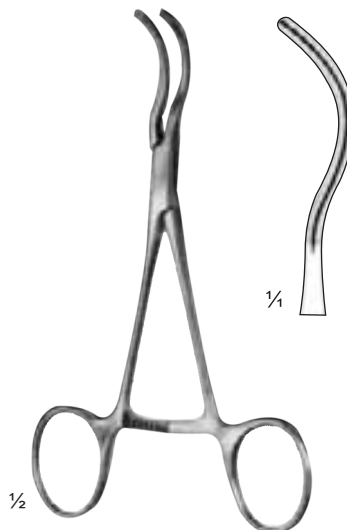

Cooley
26-508-05
14 cm / 5½"



Anastomosis Clamps

Anastomosenklemmen
Pinzas para anastomosis

Pinces-clamps pour anastomose
Pinze per anastomosi

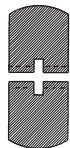
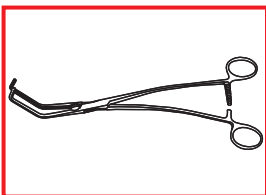

Cooley
2:2 rows of teeth

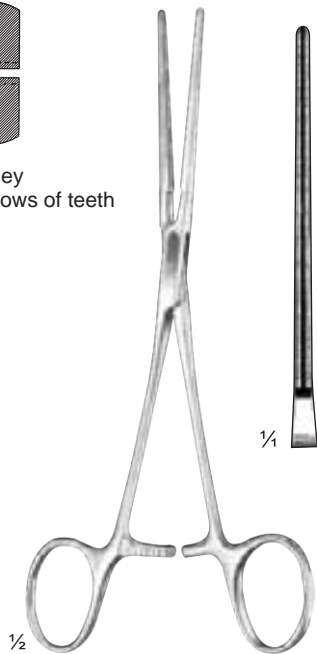

Cooley
26-512-17
17 cm / 6 3/4"

ATRAUMA



Cooley
26-513-20
20 cm / 8"

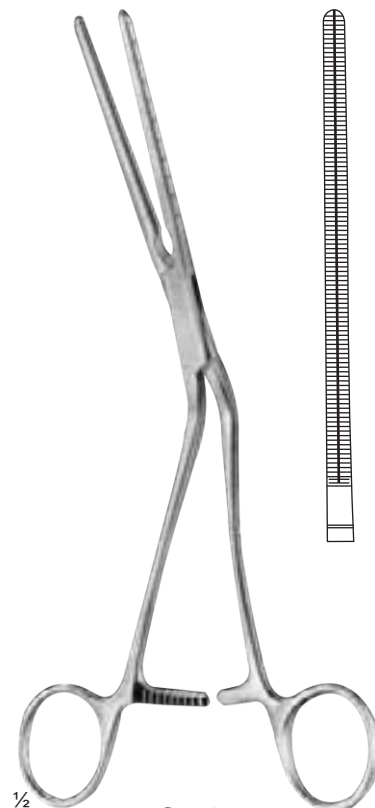

Cooley
26-515-21
21 cm / 8 1/4"



Anastomosis Clamps, Multi Purpose Vascular Clamps

Anastomosenklemmen, Mehrzweck-Gefäßklemmen
 Pinzas para anastomosis ,Pinzas vasculares de usos múltiples

Pinces-clamps pour anastomose, Pinces vasculaires universelles
 Pinze per anastomosi, Pinze vascolari universali

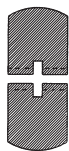

Cooley
 2:2 rows of teeth

ATRAUMA

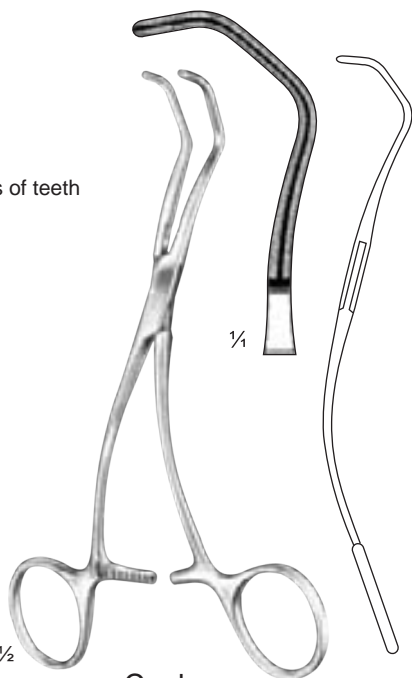

Cooley
 26-521-16
 16 cm / 6¼"



Cooley
 26-522-17
 17 cm / 6¾"

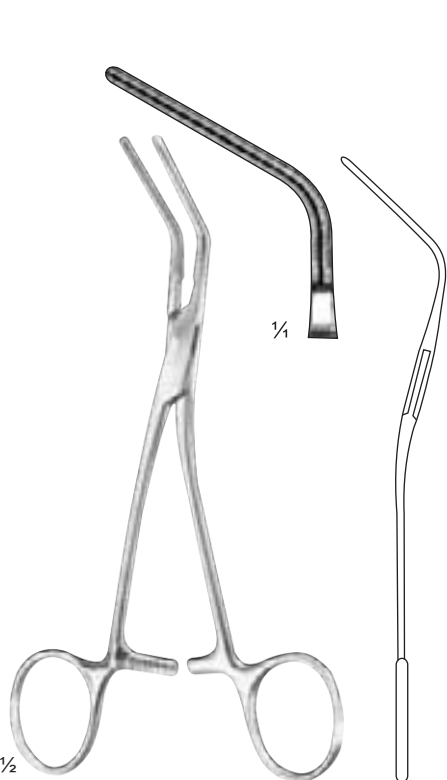

Cooley
 26-524-01
 16 cm / 6¼"

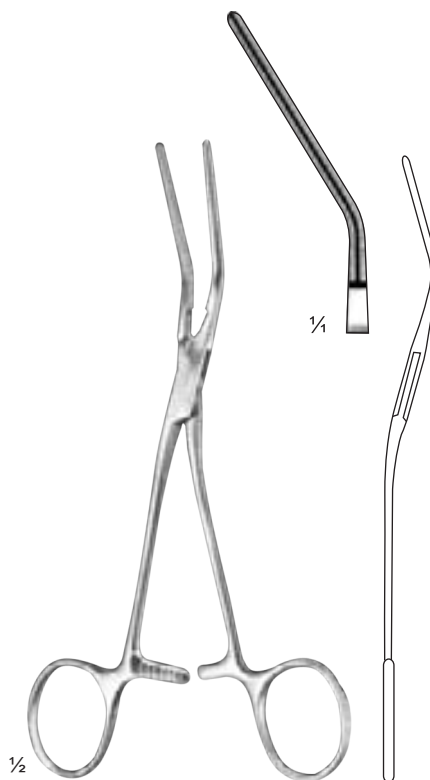

Cooley
 26-524-02
 17 cm / 6¾"

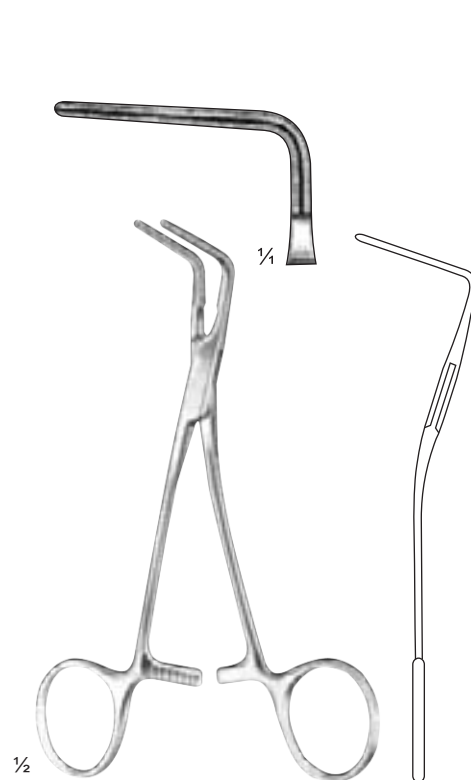

Cooley
 26-524-03
 15 cm / 6"

Multi Purpose Vascular Clamps

Mehrzweck-Gefäßklemmen
Pinzas vasculares de usos múltiples

Pinces vasculaires universelles
Pinze vascolari universali

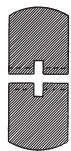

Cooley
2:2 rows of teeth

ATRAUMA

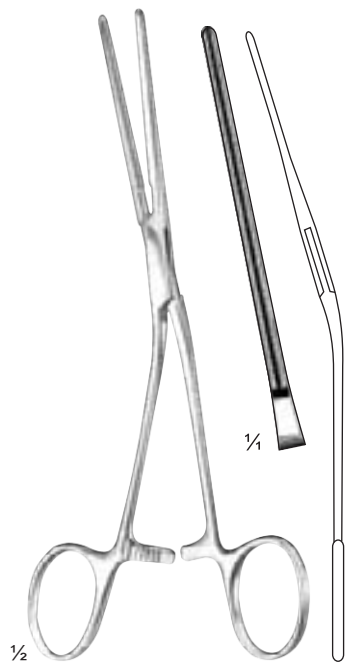

Cooley
26-529-17
17 cm / 6 3/4"

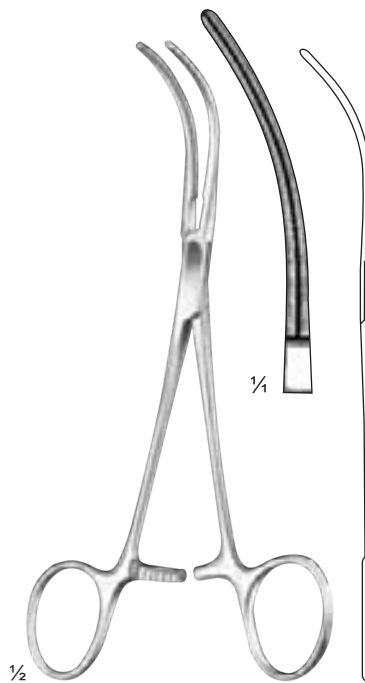

Cooley
26-530-17
17 cm / 6 3/4"

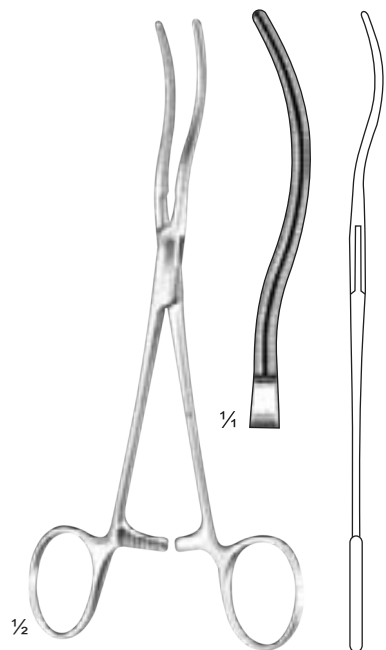

Cooley
26-532-17
17 cm / 6 3/4"



Cooley
26-533-16 - 26-533-17

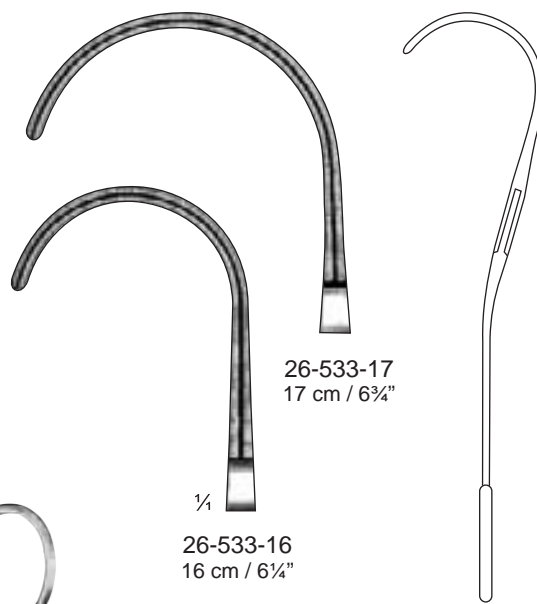

26-533-17
17 cm / 6 3/4"

26-533-16
16 cm / 6 1/4"



Aortic Dilators

Aorta-Dilatatoren
Dilatadores aórticos

Dilatateurs pour aorte
Dilatatori per aorta

Blade opening from 8-15mm
with thread fixation

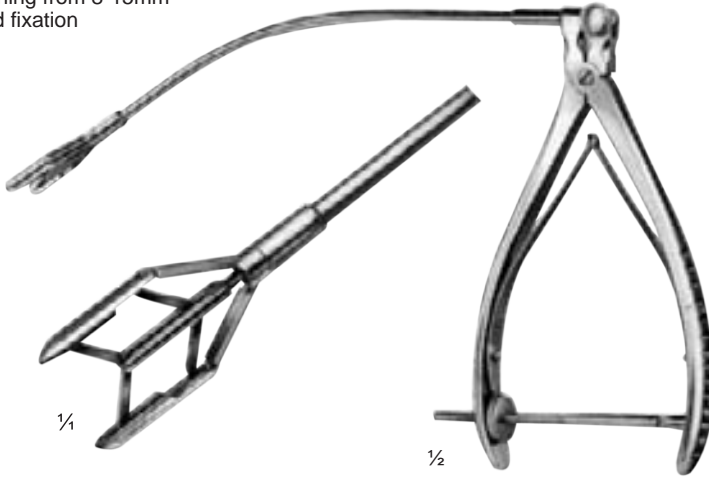

Cooley
26-538-00

Blade opening from 8 to 42mm
with fixation screw

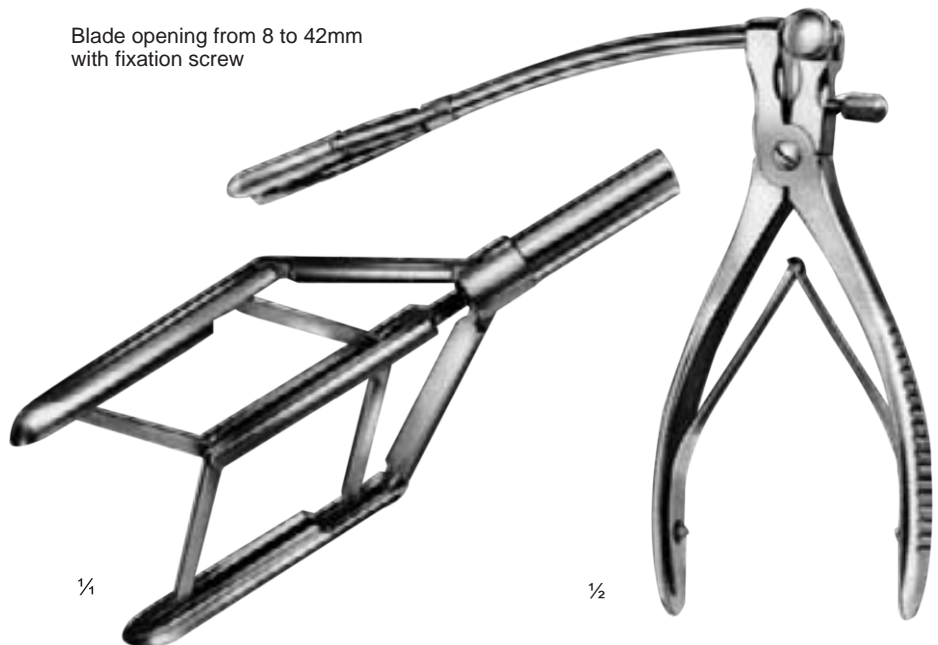

Tubbs
26-540-00

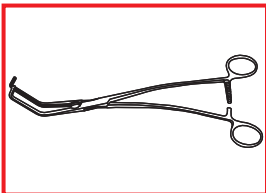

Vascular Dilators

Gefäßdilatoren Dilatateurs vasculaires
 Diladores vasculares Dilatatori vascolari

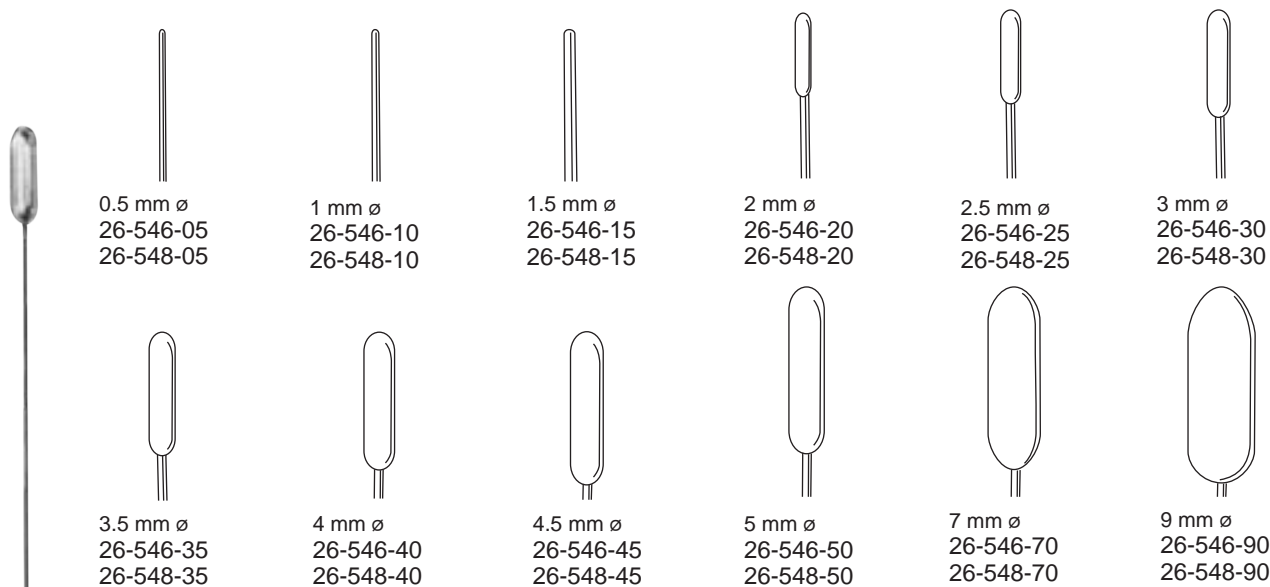

0.5 mm ø
 26-546-05
 26-548-05

1 mm ø
 26-546-10
 26-548-10

1.5 mm ø
 26-546-15
 26-548-15

2 mm ø
 26-546-20
 26-548-20

2.5 mm ø
 26-546-25
 26-548-25

3 mm ø
 26-546-30
 26-548-30

3.5 mm ø
 26-546-35
 26-548-35

4 mm ø
 26-546-40
 26-548-40

4.5 mm ø
 26-546-45
 26-548-45

5 mm ø
 26-546-50
 26-548-50

7 mm ø
 26-546-70
 26-548-70

9 mm ø
 26-546-90
 26-548-90

1/2 malleable

De Bakey
 26-546-05 - 26-548-90

mm ø	19 cm / 7 1/2"	35 cm / 14"
0.5	26-546-05	26-548-05
1.0	26-546-10	26-548-10
1.5	26-546-15	26-548-15
2.0	26-546-20	26-548-20
2.5	26-546-25	26-548-25
3.0	26-546-30	26-548-30
3.5	26-546-35	26-548-35
4.0	26-546-40	26-548-40
4.5	26-546-45	26-548-45
5.0	26-546-50	26-548-50
7.0	26-546-70	26-548-70
9.0	26-546-90	26-548-90

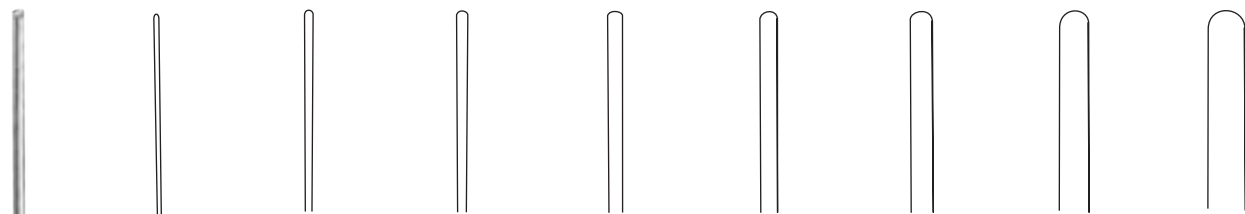

0.5mmø
 26-550-05

1 mm ø
 26-550-10

1.5mmø
 26-550-15

2 mm ø
 26-550-20

2.5mmø
 26-550-25

3 mm ø
 26-550-30

4 mm ø
 26-550-40

5 mm ø
 26-550-50

1/2 malleable

Cooley
 26-550-05 - 26-550-50
 13 cm / 5"

mm ø	13 cm / 5"
0.5	26-550-05
1.0	26-550-10
1.5	26-550-15
2.0	26-550-20
2.5	26-550-25
3.0	26-550-30
4.0	26-550-40
5.0	26-550-50

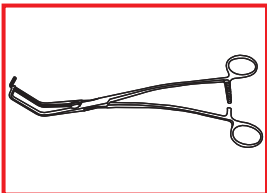

Vascular Dilators

Gefäßdilatoren Dilatateurs vasculaires
 Diladores vasculares Dilatatori vascolari



malleable

De Bakey
 26-556-00
 50 cm



malleable

Garrett

	14 cm / 5½"	21 cm / 8¼"
1.0 mm	26-558-10	26-560-10
1.5 mm	26-558-15	26-560-15
2.0 mm	26-558-20	26-560-20
2.5 mm	26-558-25	26-560-25
3.0 mm	26-558-30	26-560-30
3.5 mm	26-558-35	26-560-35
4.0 mm	26-558-40	26-560-40
4.5 mm	26-558-45	26-560-45
5.0 mm	26-558-50	26-560-50



Vascular Dilators

Gefäßdilatoren
Dilatadores vasculares

Dilatateurs vasculaires
Dilatatori vascolari

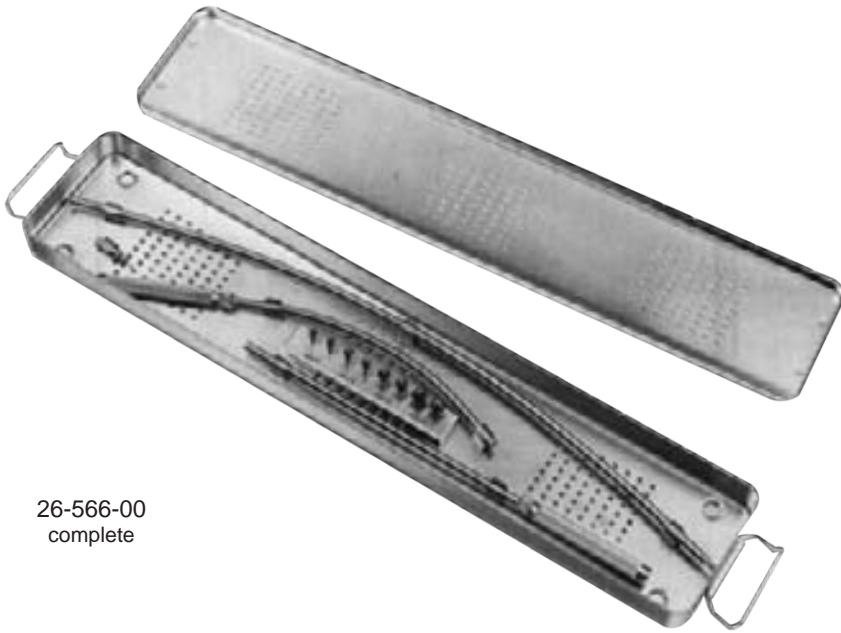

26-566-00
complete



26-566-56
6 mm



26-566-58
8 mm



26-566-60
10 mm



26-566-62
12 mm



26-566-65



26-566-70



26-566-01



26-566-05
22.5 cm



26-566-06
22.5 cm



26-566-11
54 cm

- 26-566-00 -Tunneling Set, complete
- 26-566-01 -Universal Handle (2x)
- 26-566-05 -Tunneling shaft, curved, 225 mm
- 26-566-06 -Tunneling shaft, straight, 225 mm
- 26-566-11 -Tunneling shaft, curved, 540 mm
- 26-566-56 -Bullet tip 6 mm (2x)
- 26-566-58 -Bullet tip 8 mm (2x)
- 26-566-60 -Bullet tip 10 mm (2x)
- 26-566-62 -Bullet tip 12 mm (2x)
- 26-566-65 -Vein tip
- 26-566-70 -Luer Adaptor
- 26-566-08 -Plate for tips only
- 26-566-12 -Sterilising case 550 x 115 x 35 mm

Intima Spatulas, Vascular Dissectors

Intimaspatel, Gefäßdissektoren

Spatules pour la tunique interne, Dissecteurs vasculaires

Espátulas para la íntima, Disecadores vasculares

Spatole per intima, Dissettori vascolari

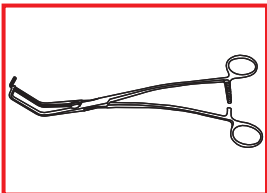

5 mm
Fig. 1

4 mm
Fig. 2

3 mm
Fig. 3

2 mm
Fig. 4



Robb
26-571-01
24 cm / 10"



Robb
26-571-02
24 cm / 10"



Robb
26-571-03
24 cm / 10"



Robb
26-571-04
24 cm / 10"

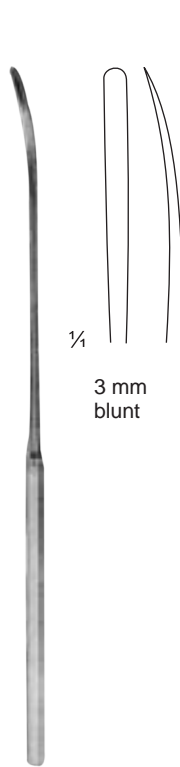

3 mm
blunt
1/4

26-573-18 = 18.5 cm / 7 1/4"
26-573-21 = 21.5 cm / 8 1/2"

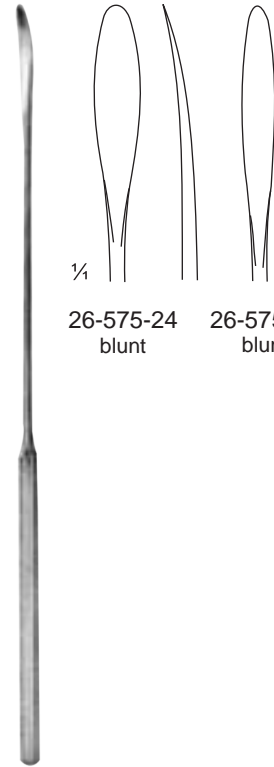

26-575-24 blunt
26-575-14 blunt
1/4

26-575-14 = 14 cm / 5 1/2"
26-575-24 = 23.5 cm / 9"

Pediatric Vascular Clamps

Kinder-Gefäßklemmen
Pinzas vasculares pediátricas

Pinces vasculaires pédiatriques
Pinze vascolari pediatriche

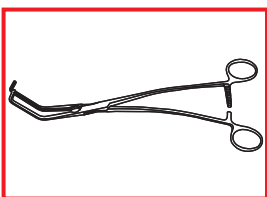

De Bakey
1:2 rows of teeth



ATRAUMA

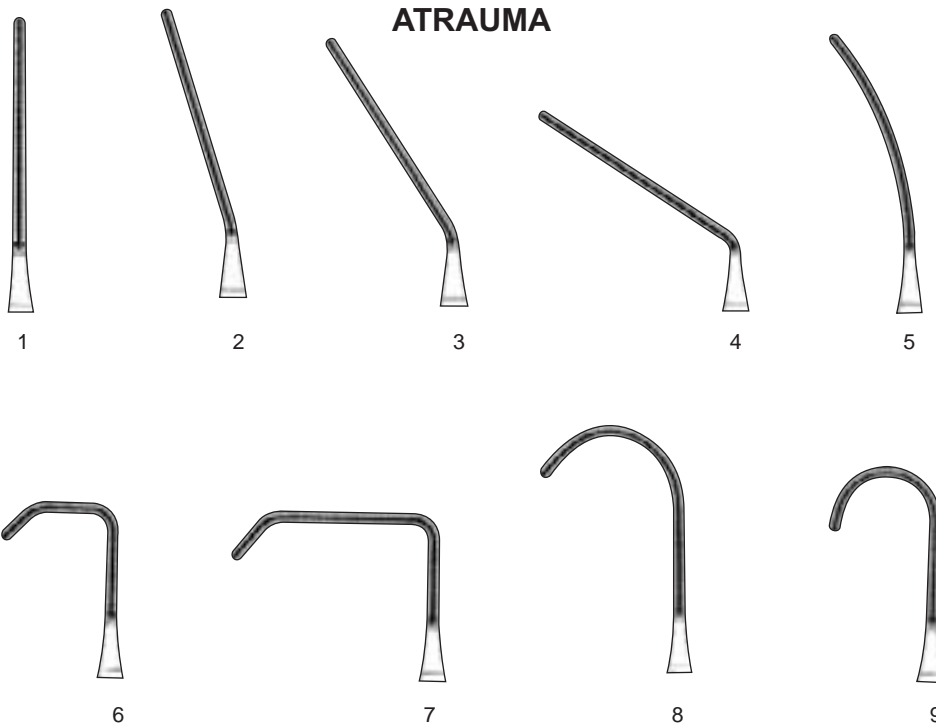

Fig. Straight

- 1 26-580-01
14.5 cm / 5¾"
- 2 26-580-02
14.5 cm / 5¾"
- 3 26-580-03
14.5 cm / 5¾"
- 4 26-580-04
14.5 cm / 5¾"
- 5 26-580-05
14 cm / 5½"
- 6 26-580-06
13.5 cm / 5¼"
- 7 26-580-07
13.5 cm / 5¼"
- 8 26-580-08
14 cm / 5½"
- 9 26-580-09
13.5 cm / 5¼"



Fig. angled

- 1 26-581-01
14.5 cm / 5¾"
- 2 26-581-02
14.5 cm / 5¾"
- 3 26-581-03
14.5 cm / 5¾"
- 4 26-581-04
14.5 cm / 5¾"
- 5 26-581-05
14 cm / 5½"
- 6 26-581-06
13.5 cm / 5¼"
- 7 26-581-07
13.5 cm / 5¼"
- 8 26-581-08
14 cm / 5½"
- 9 26-581-09
13.5 cm / 5¼"



Fig. curved

- 1 26-583-01
14.5 cm / 5¾"
- 2 26-583-02
14.5 cm / 5¾"
- 3 26-583-03
14.5 cm / 5¾"
- 4 26-583-04
14.5 cm / 5¾"
- 5 26-583-05
14 cm / 5½"
- 6 26-583-06
13.5 cm / 5¼"
- 7 26-583-07
13.5 cm / 5¼"
- 8 26-583-08
14 cm / 5½"
- 9 26-583-09
13.5 cm / 5¼"

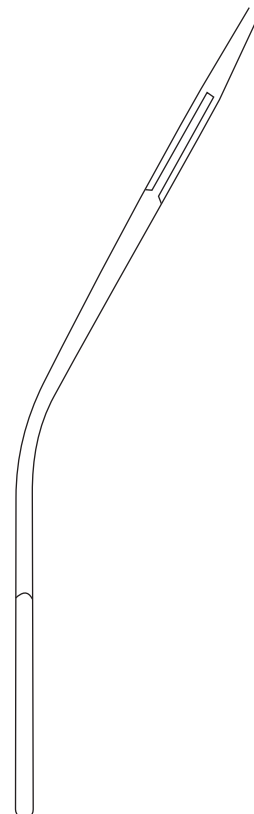

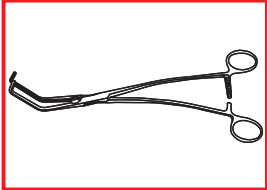

Aortic Clamps, Nerve Hooklets, Tourniquets

Aortaklemmen, Nervhäkchen, Tourniquets
 Pinzas aórticas, Ganchitos para nervios, Tourniquetes

Pinces-clamps pour aorte, Crochets pour les nerfs, Tourniquets
 Pinze per aorta, Uncini per nervi, Tornichetti



De Bakey
 1:2 rows of teeth

ATRAUMA

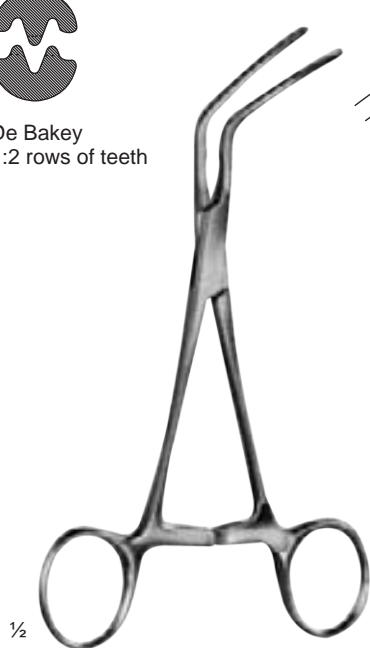

Subramanian
 26-587-16
 16 cm / 6 1/4"

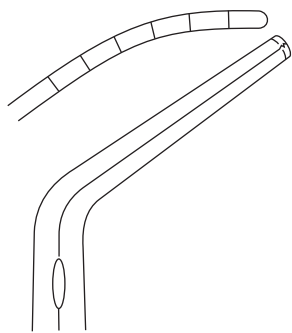

right

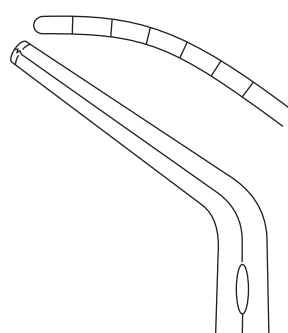

left



Subramanian
 26-589-16
 16 cm / 6 1/4"



Crile
 26-591-20 = Fig. 1
 26-593-20 = Fig. 2
 20 cm / 8"



Rumel-Belmont
 26-595-33 = 3.2 mm ø
 26-596-33 = 6.4 mm ø
 33 cm / 13" flexible

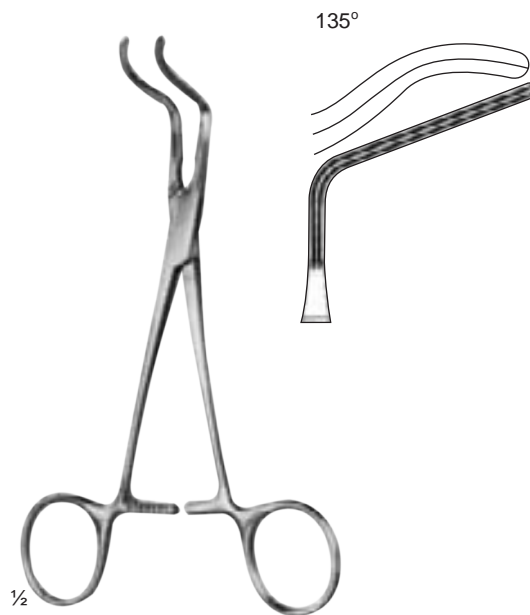

Subramanian-Miniature
 26-599-15
 15.5 cm / 6"

Pediatric Vascular Clamps

Kinder-Gefäßklemmen
Pinzas vasculares pediátricas

Pinces vasculaires pédiatriques
Pinze vascolari pediatriche



De Bakey
1:2 rows of teeth

ATRAUMA

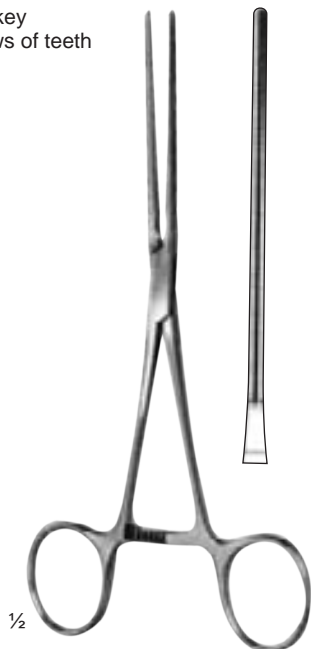

26-604-01
16.5 cm / 6½"



26-604-02
15 cm / 6"

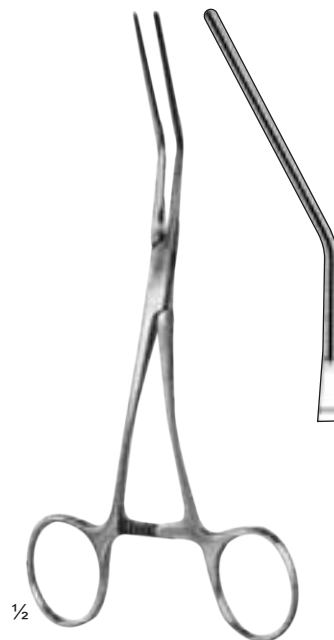

26-604-03
16 cm / 6¼"

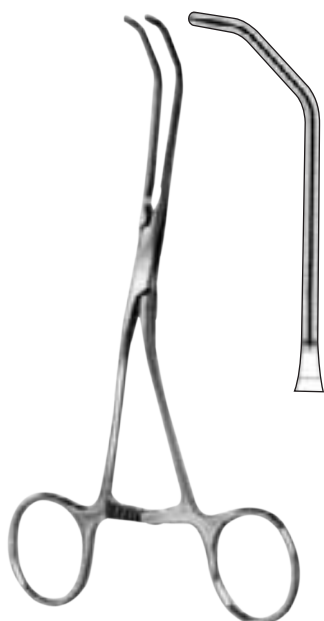

26-604-04
15.5 cm / 6"



26-604-05
15 cm / 6"

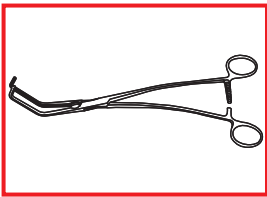

Neonatal Vascular Clamps

Neonatal-Gefäßklemmen
Pinzas vasculares para recién nacidos

Pinces vasculaires pour nouveaux nés
Pinze vascolari per neonati

ATRAUMA



1/2

Castaneda
26-613-01 - 26-617-12

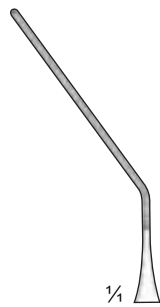

1/4

26-613-01
13 cm / 5"

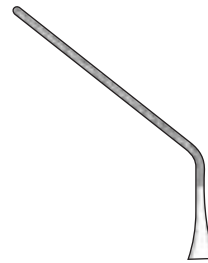

26-613-02
13 cm / 5"



26-613-03
11 cm / 4 1/2"

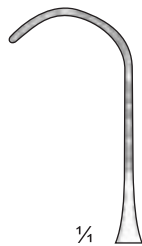

1/4

26-615-01
12 cm / 4 3/4"

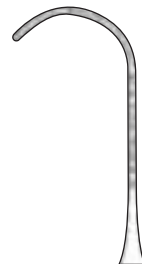

26-615-02
12 cm / 4 3/4"



26-615-03
12 cm / 4 3/4"

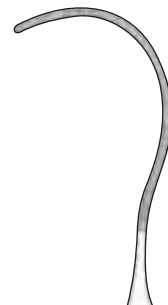

26-617-12
12 cm / 4 3/4"

