

**Falcon**<sup>®</sup>

Surgical  
Instruments



22

POST MORTEM

AUTOPSIE  
AUTOPSIA  
AUTOPSIE  
AUTOPSIA







**Operating Knives**

Operations-Skalpelle  
Bisturías para operaciones

Bistouris pour opérations  
Bisturi per interventi



16 cm / 6¼"



¼  
Fig. 2  
05-004-02



¼  
Fig. 4  
05-004-04



¼  
Fig. 9  
05-004-09



½  
Virchow  
05-005-01  
25.5 cm / 10"  
Blade 8.5 cm / 3½"



½  
Virchow  
05-005-02  
25.5 cm / 10"



## Autopsy Knives, Cartilage Knives

Seziermesser, Knorpelmesser  
Cuchillos Para autopsia, Cuchillos para cartilago

Couteaux á dissection, Couteaux á cartilage  
Coltelli per autopsia, Coltelli per cartilagini

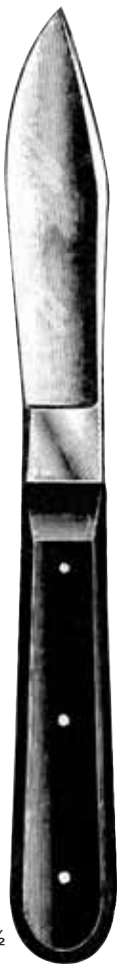

½

05-007-10  
25.5 cm / 10"  
Autopsy Knife



½

Virchow  
05-009-08  
22 cm / 8¾"  
9.5 cm / 3¾"  
cartilage Knife



½

05-010-05  
17.5 cm / 7"  
5.5 cm / 2¼"  
Dissector end



½

05-011-05  
17.5 cm / 7"  
5.5 cm / 2¼"  
Dissector end



½

Virchow  
05-012-08  
22 cm / 8¾"



**Post Mortem Knives, Brain Knives**

Organmesser, Hirnmesser  
Cuchillos para órganos y cerebro

Couteaux à autopsie et à cerveaux  
Coltelli per autopsia e cervello



05-016-16

05-016-20

05-016-24

**Virchow**

05-016-16 Blade 16 cm / 6¼"  
05-016-20 Blade 20 cm / 8"  
05-016-24 Blade 24 cm / 9½"



05-018-11

05-018-14

05-018-17

**Walb**

05-018-11 Blade 11 cm / 4¼"  
05-018-14 Blade 14 cm / 5½"  
05-018-17 Blade 17 cm / 6¾"



05-019-20

Blade 20 cm / 8" wide 25mm

05-019-25

Blade 25.5 cm / 10" wide 25mm



**Scalpel Handles**

Skalpelligriffe  
Mangos de bisturías

Manches pour bistouris  
Manici per bisturi

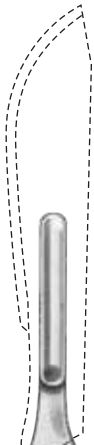

¼

05-044-04  
No. 4  
solid



¼

05-046-41  
No. 4L  
solid  
straight

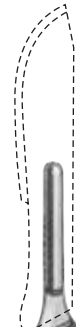

¼

05-056-03  
No. 3  
solid



¼

05-057-31  
No. 3L  
solid  
straight



### Operating Knives

Operations-Skalpelle  
Bisturías para operaciones

Bistouris pour opérations  
Bisturi per interventi

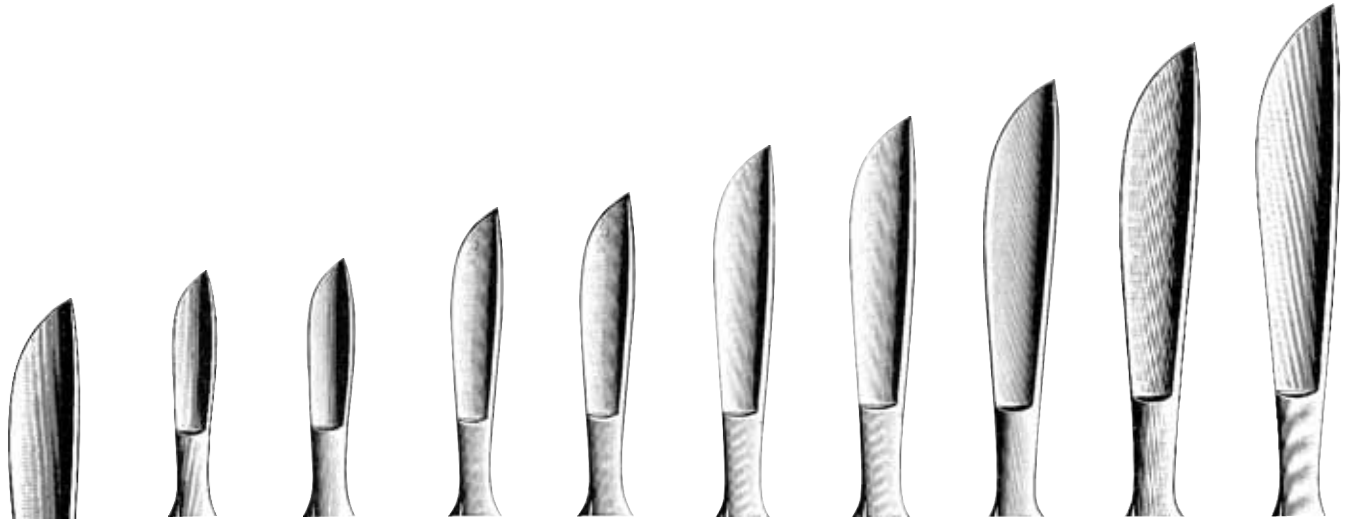

1    2    3    4    5    6    7    8    9  
05-075-01    05-075-02    05-075-03    05-075-04    05-075-05    05-075-06    05-075-07    05-075-08    05-075-09

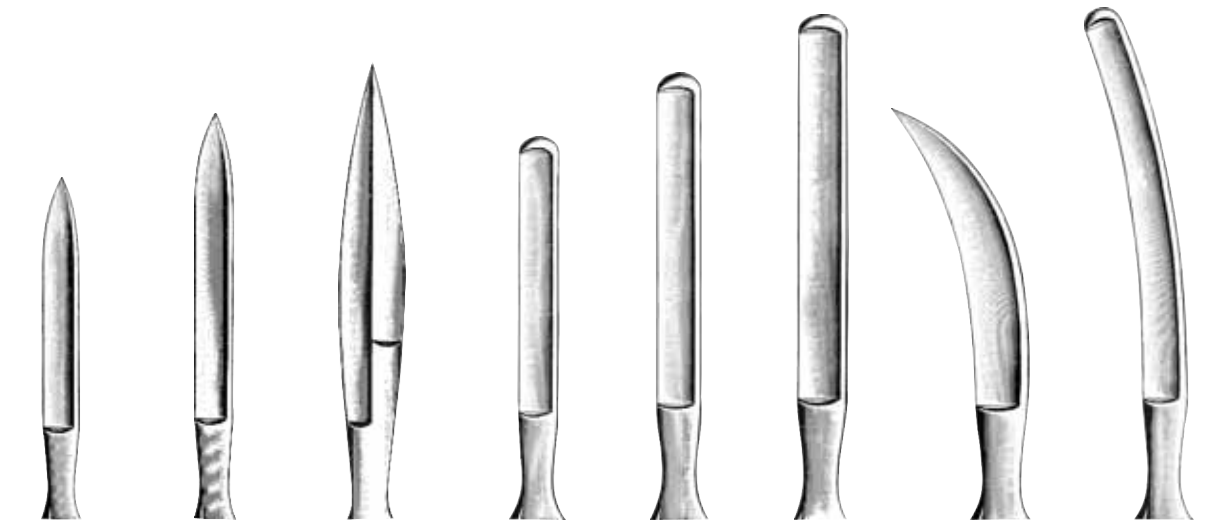
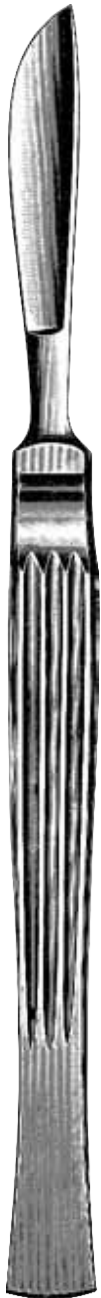

26    27    32    36    37    38    40    46  
05-075-26    05-075-27    05-075-32    05-075-36    05-075-37    05-075-38    05-075-40    05-075-46

1/4

05-075-01 - 05-075-46



## Amputating Knives

Amputationsmesser  
Cuchillos para amputación

Couteaux à amputation  
Coltelli per amputazione



1/2

Collin

05-078-13  
13 cm / 5"blade



Catlin

05-080-13  
13 cm / 5"blade



Symes/  
Langenbeck

05-084-12  
12 cm / 4 3/4"  
05-084-13  
13cm/5"blade



05-086-09  
9.5 cm / 3 3/4"  
Blade





## Resection Knives

Resektionsmesser  
Cuchillos para resección

Couteaux à résection  
Coltelli per resezione

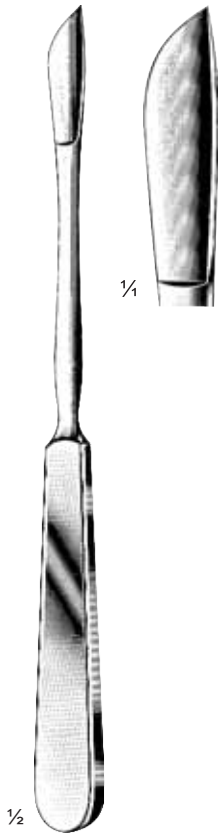

05-090-03  
3.5 cm / 1½"  
Blade



05-091-06  
6.5 cm / 2½"  
Blade



Langenbeck  
05-102-05  
5.5 cm / 2¼"  
Blade



Langenbeck  
05-104-05  
5.5 cm / 2¼"  
Blade



### Operating Scissors

Chirurgische Scheren  
Tijeras quirúrgicas

Ciseaux chirurgicaux  
Forbici per chirurgia



1/2

Standard

06-002-20-06-014-20



Fig. 1



Fig. 2



Fig. 3

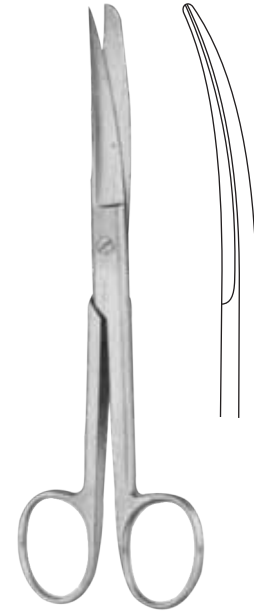

Standard

cm	in.	Fig. 1	Fig. 2	Fig. 3
11.5	4 1/2			06-014-11
13.0	5		06-008-13	06-014-13
14.5	5 3/4		06-008-14	
15.5	6		06-008-15	
16.5	6 1/2		06-008-16	06-014-16
18.5	7 1/4		06-008-18	
20.0	8	06-002-20	06-008-20	06-014-20
				06-025-13
				06-025-14
				06-025-15
				06-025-16



06-052-13 = 13 cm / 5"  
06-052-14 = 14.5 cm / 5 3/4"  
06-052-16 = 16.5 cm / 6 1/2"

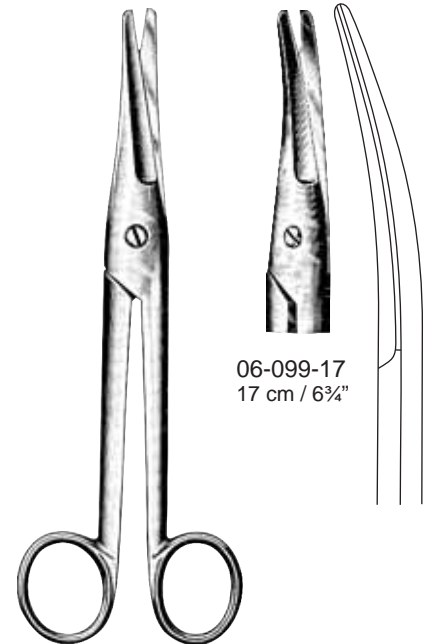

Mayo-Noble

06-098-17  
17 cm / 6 3/4"

06-099-17  
17 cm / 6 3/4"



**Vascular Scissors, Enterotomy Scissors**

Gefäßscheren, Darmscheren  
Tijeras vasculares, Tijeras para intestino

Ciseaux vasculaires, Ciseaux-entérotomes  
Forbici vascolari, Forbici per enterotomia



06-332-11  
11.5 cm / 4½"

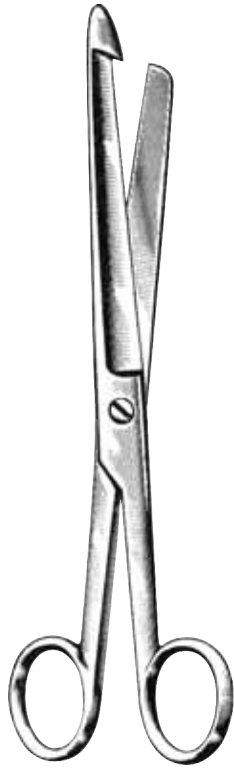

06-601-21  
21 cm / 8¼"

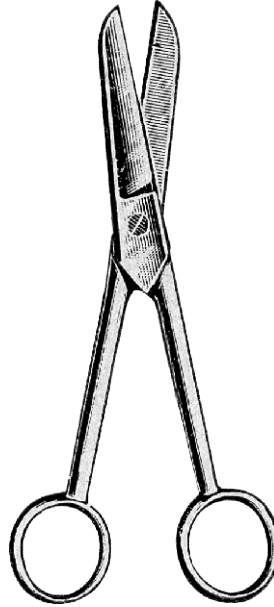

06-602-16  
16 cm / 6¼"  
strong



06-603-25  
25.5 cm / 10"  
Heavy

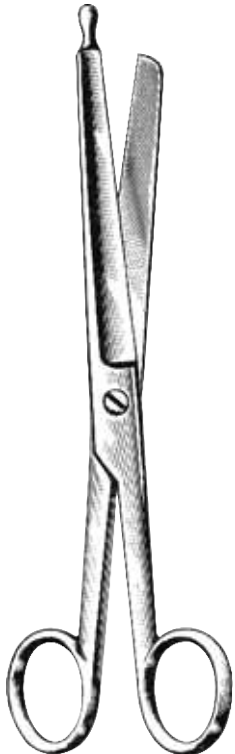

06-604-21  
21 cm / 8¼"



06-675-14  
14.5 cm / 5¾"



06-678-14  
14.5 cm / 5¾"

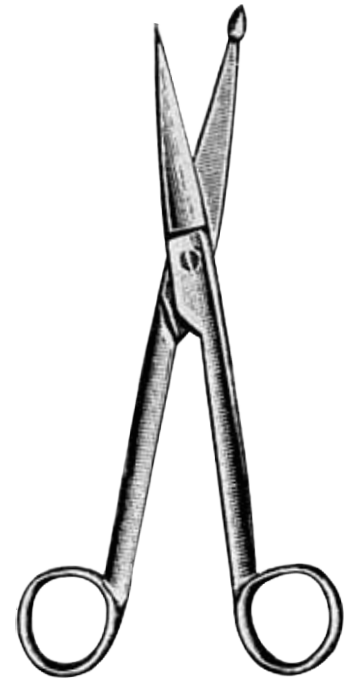

06-679-18  
18 cm / 7¼"



### Dissecting Forceps, Tissue Forceps

Chirurgische Pinzetten, Anatomische Pinzetten  
 Pinzas de disección, Pinzas de disección con diente

Pinces à dissection, Pinces à dissection à griffes  
 Pinze per dissezione, Pinze per dissezione con denti



cm	in.	Standard	Narrow	1:2	Narrow
13.0	5	07-002-13	07-004-13	07-135-13	07-153-13
14.5	5 ¾	07-002-14	07-004-14	07-135-14	07-153-14
16.0	6 ¼	07-002-16	07-004-16	07-135-16	07-153-16
18.0	7	07-002-18	07-004-18	07-135-18	
20.0	8	07-002-20	07-004-20	07-135-20	07-153-20
25.0	9¾	07-002-25	07-004-25	07-135-25	
30.0	11¾	07-002-30	07-004-30	07-135-30	



### Probes, Blow Pipes

Sonden, Tubulus  
Sondas, Tubos

Sondes, Tube  
Sonde, Tubo



**Kronecker**  
10-020-13  
13 cm / 5"



**Johns-Hopkins**  
10-021-15  
15 cm / 6"



11-004-14 = 14.5 cm / 5¾"  
11-004-16 = 16 cm / 6¼"  
11-004-18 = 18 cm / 7"  
11-004-20 = 20 cm / 8"  
2mmø



**Myrtle Leaf**  
11-022-14 = 14.5 cm / 5¾"  
11-022-16 = 16 cm / 6¼"  
11-022-20 = 20 cm / 8"



11-024-11 = 11.5 cm / 4½"  
11-024-13 = 13 cm / 5"  
11-024-14 = 14.5 cm / 5¾"  
11-024-16 = 16 cm / 6¼"



22-011-00  
23.5 cm / 9¼"



22-011-01  
Straight (extra tip)



22-011-02  
curved (extra tip)



22-012-01  
15 cm / 6"  
curved



**Measuring Instruments**

Messinstrumente  
Instrumentos para medidas

Instruments pour mesurer  
Strumenti per misurare



1/2

**Bertillon**  
12-092-01  
32 cm / 12½"



1/2

**Vernier**  
12-108-01

Tape Measure, graduated in centimeters and inches.

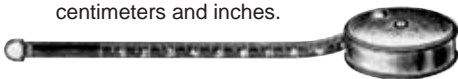

12-151-15  
Linen  
150cm/59"

12-151-20  
Steel  
200cm/78¾"



12-153-15    15 cm / 6"  
12-153-20    20 cm / 8"  
12-153-30    30.5 cm / 12"  
12-153-50    50 cm / 19¾"



### Amputation Saws

Amputationssägen  
Sierras de amputación

Scies à amputation  
Seghe per amputazione



**Satterlee**  
24-002-31  
31 cm / 12¼"



**Charriere**  
24-004-27 = 27 cm / 10¾"  
24-004-30 = 30 cm / 11¾"

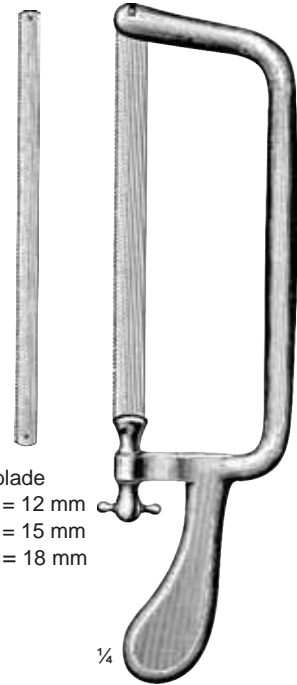

Spare saw blade  
24-013-92 = 12 mm  
24-013-95 = 15 mm  
24-013-98 = 18 mm

**Charriere**  
24-013-35  
35 cm / 14"

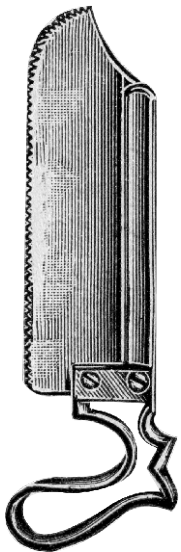

24-014-28  
Fixed back and handle  
20 cm / 8" blade



24-015-28  
without guide handle  
length of blade 16cm  
28 cm / 11"  
Twin saw



24-016-28  
with guide handle  
28 cm / 11"  
Twin saw



### Skull breaker, rachiotome, Sternum Chisel, Osteotome

Schädelspalter, Rachiotom, Sternummeißel, Osteotom  
 Divisore per cranio, Rachiotomi, Scalpello per sterno, Osteotomo

Cinzel rompe-cráneo, Rauiótomos, Cinceles de esternón, Osteotomo  
 Apri cranio, Rachiotome, Costotomi, Osteotomi

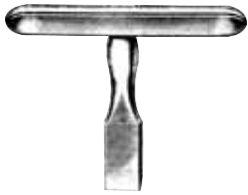

**Virchow**  
 22-036-00  
 with 15mm Blade  
 skull breaker



22-040-25  
 25mm Blade  
 Loose cross handle



22-042-25  
 Skull Breaker  
 25mm Blade  
 14 cm / 5½"



**Rachiotome**  
 22-043-22  
 22 cm / 8¾"



22-045-20  
 20 cm / 8"



22-047-21  
 21.5 cm / 8½"  
 Spine wrench



**Virchow**  
 22-049-15 = 15mm  
 22-049-18 = 18mm  
 22-049-22 = 22mm  
 13.5 cm / 5¼"

19mm



22-051-18  
 18 cm / 7"



**Brunetti**  
 22-053-01  
 28 cm / 11"  
 left



**Brunetti**  
 22-053-02  
 28 cm / 11"  
 right





**Osteotomes, Chisels, Gouges**

Osteotome, Flachmeißel, Hohlmeißel  
 Osteótomos, Cinceles, Gubias

Ostéotomes, Ciseaux-burins, Gouges  
 Osteotomi, Scalpelli, Sgorbie

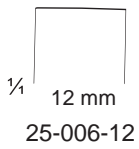
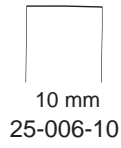

25-006-08 - 25-006-12  
 13.5 cm / 5 1/4"

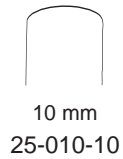

25-010-08 - 25-010-12  
 13.5 cm / 5 1/4"

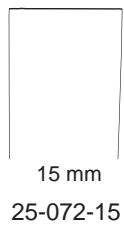
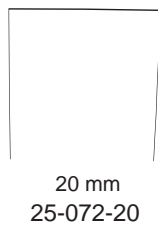
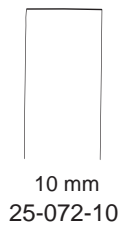

**Stille**  
 25-072-10 - 25-072-25  
 20 cm / 8"



25-092-24  
 24.5 cm / 9 3/4"

**Mallets**

Hämmer  
Martillos

Maillets  
Martelli

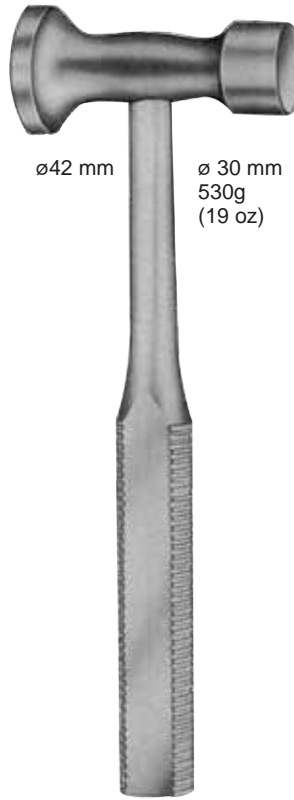
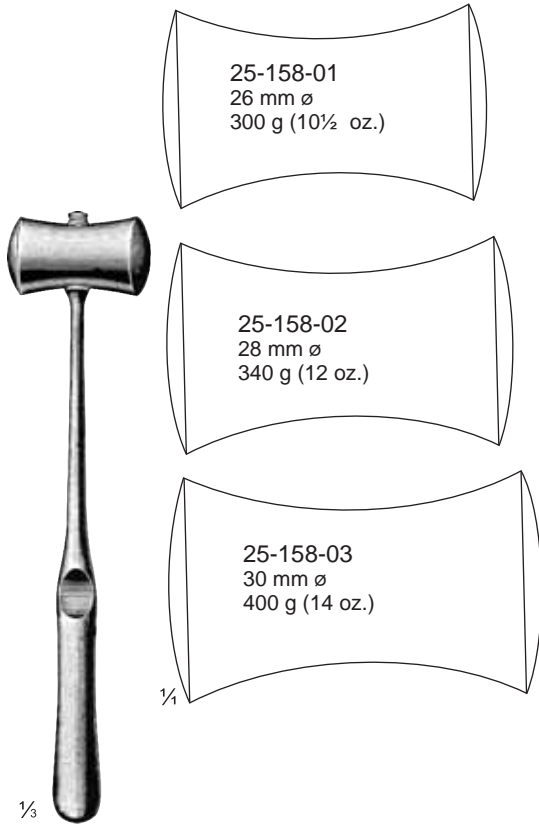

**Williger/Army Patt**  
25-158-01 - 25-158-03  
24 cm / 9½"

25-200-24  
24 cm / 9½"

25-212-26  
26.5 cm / 10½"  
steel, solid

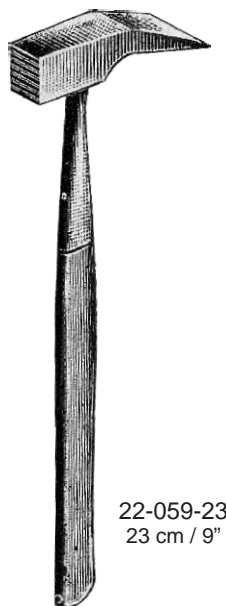



**Bone Holding Forceps**

Knochenhaltezangen  
Pinzas para hueso

Daviers porte-os  
Tenaglie per ossa

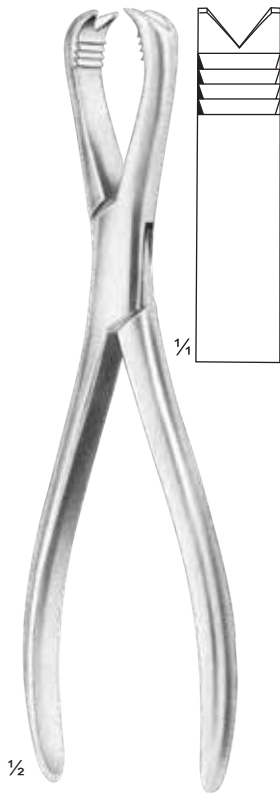

1/2

**Langenbeck**  
25-752-21  
21 cm / 8 1/4"

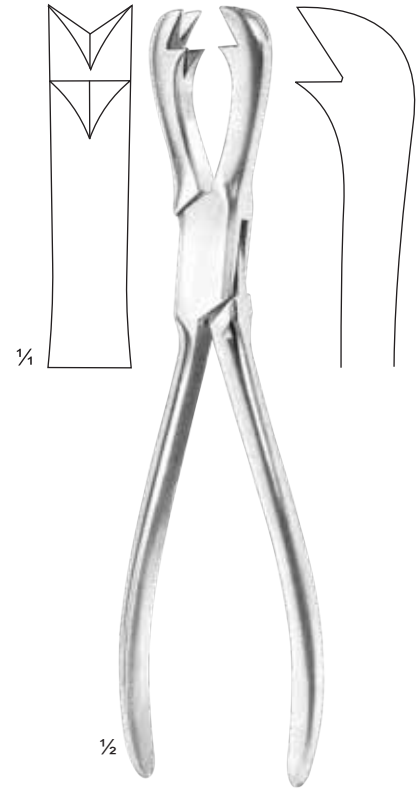

1/2

**Fergusson**  
25-756-21  
21 cm / 8 1/4"



**Semb**  
25-763-19  
19 cm / 7 1/2"



**Langenbeck**  
25-765-21  
21.5 cm / 8 1/2"

**Rib Shears**Rippenscheren  
CostótomosCostotomes  
Costotomi

½

26-003-22  
22 cm / 8¾"

½

**Bone Shear**  
26-004-23  
23 cm / 9"

½

**Gluck**  
26-005-22  
22 cm / 8¾"with eccentric  
sliding blade



### Vessel Clamp

For Embalming

22-065-15 = 15 cm / 6"

22-065-18 = 18 cm / 7"

22-065-19 = 19 cm / 7½"

Muscle Retractors (Hooks)  
Muskelhaken  
Ecarteurs musculaires  
Separadores (ganchos) musculares  
Divaricatori (unicini) muscolari



22-067-06 = 6.5 cm / 2½"  
22-067-10 = 10.5 cm / 4¼"

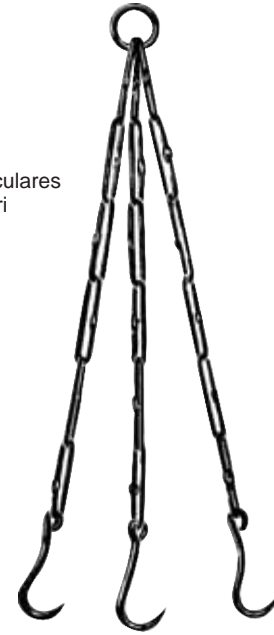

22-069-03  
Triple Chain Hook  
(Set of 3 sharp hooks  
with chain)

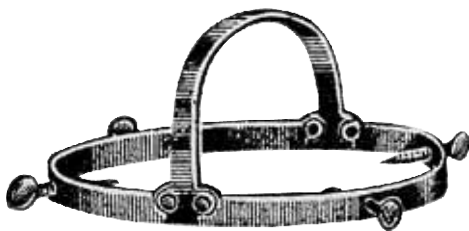

22-071-00  
Lund skull coronet  
folding, raised metal bar, adult,  
(20 x 17.5 cm) 8" x 7"

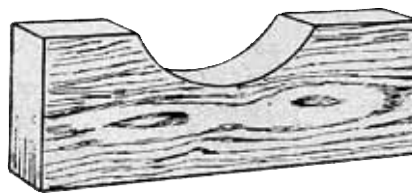

22-073-00  
Skull Rest, Plain wood  
33 x 15 x 5.5 cm

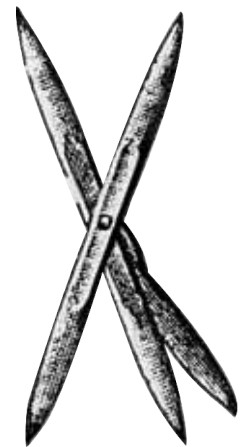

22-079-02 Skull Rest Tripod.  
22-079-03 Skull Rest Bipod



### Surgical Needles

Chirurgische Nadeln  
Agujas quirúrgicas

Aiguilles Chirurgicales  
Aghi Chirurgici

Post mortem needles  
Sektionsnadeln  
Agujas para autopsia  
Aiguilles á autopsie  
Aghi per autopsia

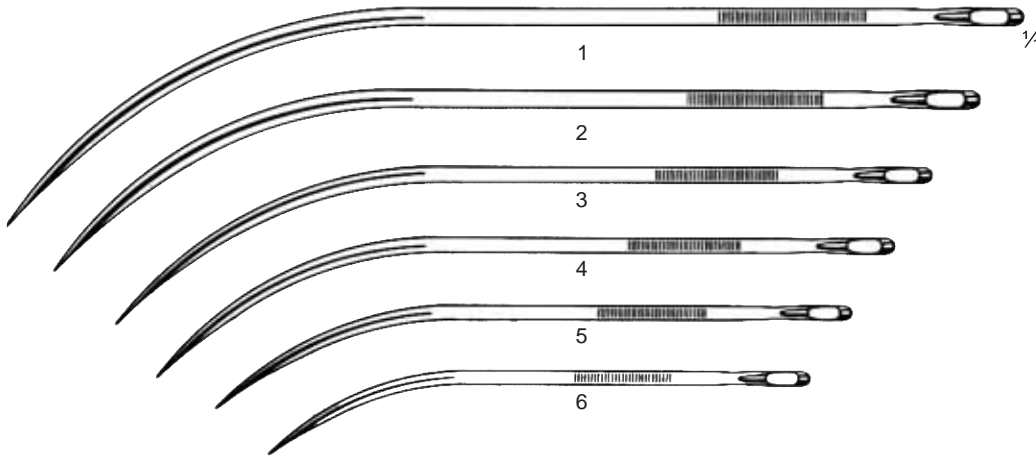

From PM/A

-  ▲
- 22-085-01 Fig.1
- 22-085-02 Fig.2
- 22-085-03 Fig.3
- 22-085-04 Fig.4
- 22-085-05 Fig.5
- 22-085-06 Fig.6
- Package of 12

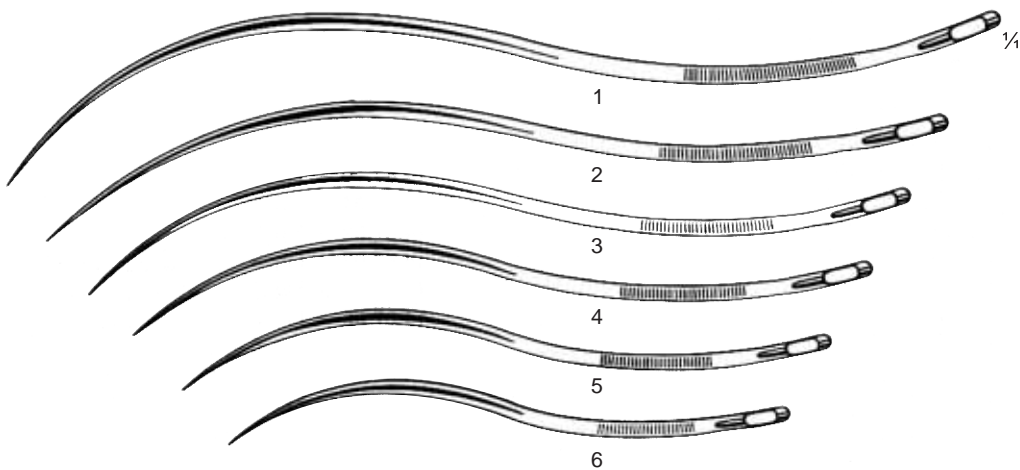

From PM/S

-  ▲
- 22-087-01 Fig.1
- 22-087-02 Fig.2
- 22-087-03 Fig.3
- 22-087-04 Fig.4
- 22-087-05 Fig.5
- 22-087-06 Fig.6
- Package of 12



### Blood scoops'

Blutschöpfel  
Cuch aprones para sangre

Scoopes Sang  
Sangue Scoopes



1/3

22-093-28  
28 cm / 11"  
scoop 50 X 45 mm

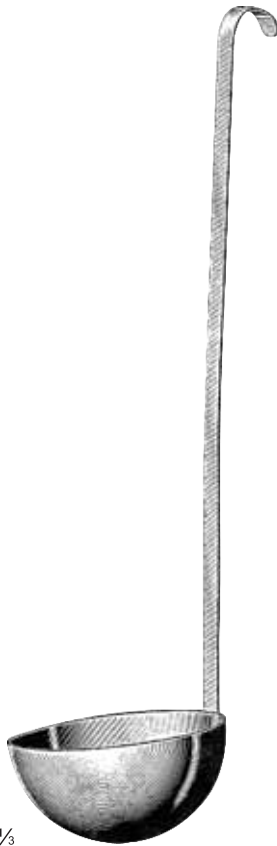

1/3

22-095-33  
33 cm / 13"  
85 mm ø  
100 ccm  
Blood Scoop, 9cu. inches



22-097-20  
20 cc

Medicine Spoon  
Medizinlöffel  
Chchara medicinal  
Cuiller pour medicamentis  
Cucchiaio per medicina



## Post Mortem Set

Autopsie-Besteck  
Juego de Autopsia

Set á autopsie  
Set per autopsia



22-101-00 Mini Post Mortem Set, in wooden case, consisting of:

- 24-014-28 1 saw with fixed back
- 05-012-08 1 cartilage knife
- 05-004-04 2 scalpels
- 22-040-25 1 chisel with cross handle
- 22-047-21 1 Spine Wrench
- 22-057-19 1 Hammer
- 06-601-21 1 Bowel Scissors 21 cm / 8¼"
- 06-602-16 1 Strong Scissors
- 07-002-13 1 Dissecting Forceps 13 cm / 5"
- 22-069-03 1 Set of 3 Sharp Hooks
- 22-012-01 1 Blowpipe
- 22-091-00 1 Pkt. of Twine 4.5mm
- 22-085-04 1 PKT OF 6 Needles 102mm  
1 Wooden Case 6" x 3" x 13½"  
(152 mm x 76 mm x 343 mm)

22-102-00 Major Post Mortem Set, in wooden case, consisting of:

- 24-014-28 1 Saw with fixed back
- 05-012-08 1 Cartilage knife
- 05-012-08 1 catlin, Single-edged
- 22-049-15 1 Chisel
- 07-002-13 1 Diss forceps 13 cm / 5"
- 05-019-20 1 Brain Knife
- 05-004-02 2 Scalpels, No.2
- 05-004-04 1 Scalpel No.4
- 22-040-25 1 Chisel with cross handle
- 22-057-19 1 hammer
- 22-071-00 1 Skull Cornet
- 22-047-21 1 Spine Wrench
- 06-601-21 1 Bowel Scissors 21 cm / 8¼"
- 06-014-11 1 Scissors fine pointed
- 07-002-13 1 Dissecting Forceps 13 cm / 5"
- 22-069-03 1 Set of 3 Sharp Hooks
- 27-012-01 1 Blowpipe
- 22-091-00 1 Pkt. of Twine 4.5 mm
- 22-085-04 1 PKT of 6 needles 102 mm  
1 Wooden Case 10½" x 2½" x 14½"  
(267mm x 73mm x 368mm)

22-105-00 Post Mortem Set in Wooden case, consisting of:

- 05-004-02 2 Dissecting Knives
- 05-004-04 1 Dissecting Knife
- 05-019-20 1 Post Mortem Knife
- 05-012-08 1 Cartilage Knife
- 06-052-13 1 Scissors with probe-end, straight 13 cm / 5"
- 07-002-13 1 Dressing Forceps, 13 cm / 5"
- 24-014-28 1 Hand saw
- 25-212-26 1 Metal hammer
- 22-049-15 1 Osteotome
- 22-067-10 2 Dissecting Hooks, double
- 22-011-00 + 22-011-01 2 Blow Pipes, double,
- 11-004-14 2 Probes with olive-ends, 14.5 cm / 5¾"
- 22-085-04 3 Suture Needles, assorted sizes  
1 Wooden Case 6" x 3" x 13½"  
(152mm x 76mm x 343mm)

22-108-00 Post Mortem set in wooden case consisting of:

- 05-004-02 1 Scalpel, metal handle
- 05-004-04 1 Scalpel
- 05-004-09 1 Scalpel
- 05-012-08 1 Cartilage knife metal handle
- 05-019-20 1 Post mortem Knife, metal handle
- 06-052-14 1 Incision Scissors, Probe pointed, 14.5 cm / 5¾"
- 26-004-23 1 Bone Shears, 23 cm / 9"
- 06-601-21 1 Bowel Scissors, with hook, 21cm / 8¼"
- 07-002-13 2 Dissecting Forceps, 13 cm / 5½"
- 24-002-31 1 Bone saw
- 22-212-26 1 Metal mallet
- 25-006-10 2 Chisels
- 22-043-22 1 Rachiotome (Spine wrench)
- 22-011-00 + 22-011-01 2 Blow Pipes, double, straight
- 22-067-10 2 Retractors, double
- 11-004-14 2 Probes with olive-ends 14.5 cm / 5¾"
- 22-085-04 2 Post mortem needles, assorted
- 12-151-15 1 Measuring Tape
- 22-096-00 1 Measuring glass, 100 ccm  
1 Wooden Case 6" x 3" x 13½"  
(152mm x 76mm x 343mm)





### Post Mortem Set

Autopsie-Besteck  
Juego de Autopsia

Set á autopsie  
Set per autopsia



22-115-00 Post Mortem set, in wooden case consisting of:

- 05-016-24 1Autopsy knife, large, metal handle
- 05-016-16 1Autopsy Knife, small,metal handle
- 05-007-10 1 Autopsy knife, large wooden handle
- 05-012-08 1 Cartilage knife
- 06-053-14 2 Incision scissors, probe pointed 14.5 cm / 5¾"
- 06-601-21 1 Bowel scissors, 21 cm / 8¼"
- 07-002-16 1 Dissecting forceps, 16 cm / 6¼"
- 07-135-14 1 Dissecitng forceps, 1 x 2 teeth,14.5 cm / 5¾"
- 07-135-25 1 Dissecting forceps, 1 x 2 teeth, 25 cm / 9¾"
- 11-024-16 1 Director, 16 cm / 6¼"
- 11-004-20 2 Probes, 20 cm / 8"
- 22-085-04 3 Post mortem needles, half curved, with long shaft
- 12-153-20 1 Steel ruler, 30 cm / 12"
- 12-151-15 1 Tape measure, 150cm long  
1Wooden Case 6" x 3" x 13½"  
(152mm x 76mm x 343mm)

22-118-00 Post Mortem set, in wooden case consisting of:

- 24-013-35 1 Bone saw with 3 blades (24-013-92 - 24-013-98)
- 26-004-23 1 Bone shears, 23 cm / 9"
- 25-765-21 1 Bone holding forceps, with heavy teeth, 21.5 cm / 8½"
- 25-092-24 1 Chisel, 20mm broad
- 25-212-26 1 Mallet, metal
- 22-042-25 1 Skull breaker, metal
- 22-093-28 1 Blood scoop
- 14-132-24 1 Microscopic needle holder 24 cm / 9½"
- 23-017-18 1 Loop of calcinable C-metal (can be flamed) 50mm, 5"
- 23-042-00 1 Dermatograph, red  
1Wooden Case 6" x 3" x 13½"  
(152mm x 76mm x 343mm)

22-119-00 Small set in wooden case, consisting of:

- 05-004-04 4 Dissecting Knives
- 05-012-08 1 Cartilage Knife
- 06-052-13 1 Incision Scissors, 13 cm / 5"
- 07-052-13 1 Dissecting Forceps, 13 cm / 5"
- 24-004-27 1 Amputation Saw Charrière
- 25-212-26 1 Mallet
- 22-051-18 1 Chisel
- 22-067-10 2 Retractors, double ended
- 22-011-00 2 Blow Pipes, double 22-011-01
- 11-004-14 2 Probes, 14.5 cm / 5¾"
- 22-085-04 3 Post Mortem Needles  
1Wooden Case 6" x 3" x 13½"  
(152mm x 76mm x 343mm)

22-125-00 Post mortem set in wooden case consisting of:

- 26-004-23 1 Bone cutting forceps
- 07-002-16 1 Dissecting forceps 16 cm / 6¼"
- 05-075-01 - 05-075-06 6 Scalpels, size 1-6
- 05-080-13 1 Catlin knife
- 22-085-04 6 P.M.Needles
- 22-079-02 1 Skull rest tripod
- 22-040-25 1 Rectangular Chisel
- 22-047-21 1 Spine wrench
- 22-059-19 1 Hammer with hatchet
- 24-014-28 1 P.M. Saw,, s.s. blade
- 06-601-21 1 Bowel Scissors 21 cm / 8¼"
- 06-014-13 1 Dissecting Scissors 13 cm / 5"
- 06-602-16 1 P.M. Scissors 16 cm / 6¼"
- 05-019-20 1 Brain Knife 20 cm Blade
- 05-012-08 1 Cartilage Knife  
1Wooden Case 6" x 3" x 13½"  
(152mm x 76mm x 343mm)

