



23

MICROSCOPY

MIKROSKOPIE
MICROSCOPIA
MICROSCOPIE
MICROSCOPIA



Operating Knives, Scalpel Handles, Razors

Operations-Skalpelle, Skalpellgriffe, Rasiemesser
 Bisturías para operaciones, Mangos de bisturías, Navajas

Bistouris pour opérations, Manches pour bistouris, Rasoirs
 Bisturi per interventi, Manici per bisturi, Rasoi



Fig. 1
05-004-01



Fig. 2
05-004-02



Fig. 3
05-004-03



13.5cm/5 1/4"



05-005-01



05-005-02

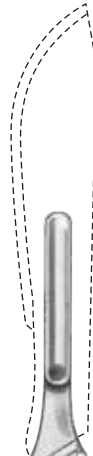

05-044-04
No. 4
solid

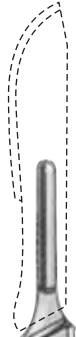

05-056-03
No. 3
solid

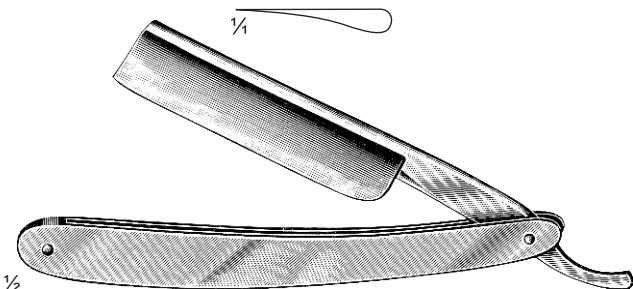

05-097-00
cutting length 8 cm / 3 1/4"
(Metal Handle)

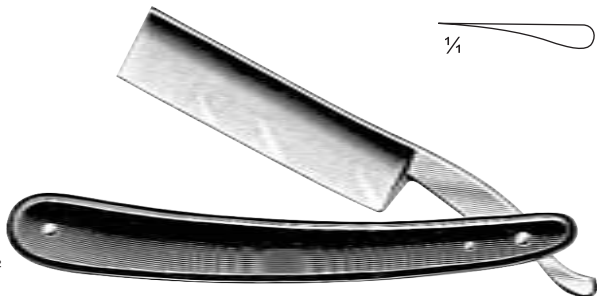

05-099-00
cutting length 8 cm / 3 1/4"
(Metal Handle)

Operating Scissors

Chirurgische Scheren
Tijeras quirúrgicas

Ciseaux chirurgicaux
Forbici per chirurgia



1/2

Standard



06-002-11
11.5cm / 4½"
06-002-13
13 cm / 5"



06-019-11
11.5 cm / 4½"
06-019-13
13 cm / 5"



06-008-11
11.5 cm / 4½"
06-008-13
13 cm / 5"



06-025-11
11.5 cm / 4½"
06-025-13
13 cm / 5"



06-014-11
11.5 cm / 4½"
06-014-13
13 cm / 5"



06-031-11
11.5 cm / 4½"
06-031-13
13 cm / 5"



06-052-13 = 13 cm / 5"
06-052-14 = 14.5 cm / 5¾"

Fine Operating Scissors Micro Scissors

Feine chirurgische Scheren, Mikroscheren
Tijeras finas para cirugía, Micro-Tijeras

Ciseaux fins à chirurgie, Micro-Ciseaux
Forbici fini per chirurgia, Micro-Forbici

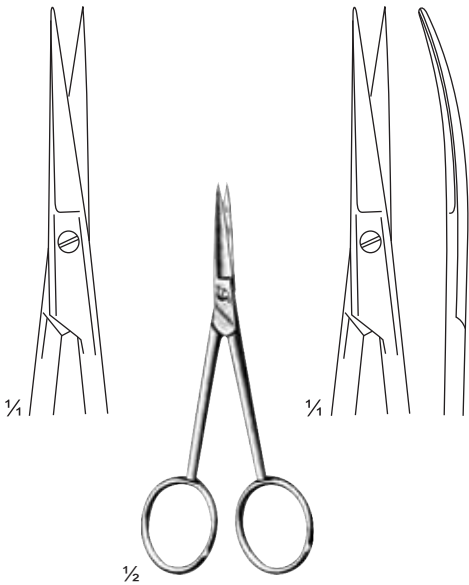
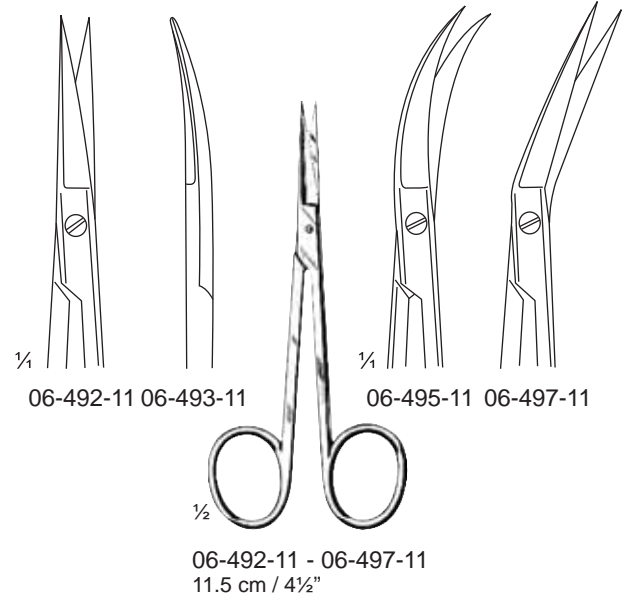
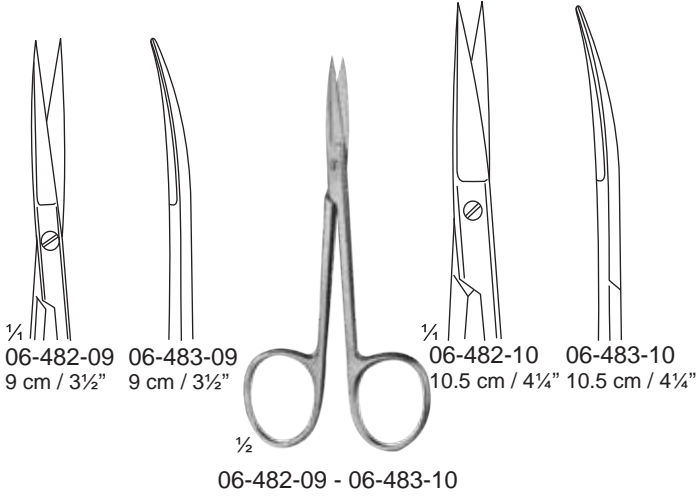

06-518-11 11.5 cm / 4 1/2" 06-519-11
06-518-13 13 cm / 5" 06-519-13
06-518-15 15 cm / 6" 06-519-15

06-768-14
14.5 cm / 5 3/4"
Double Action
very delicate

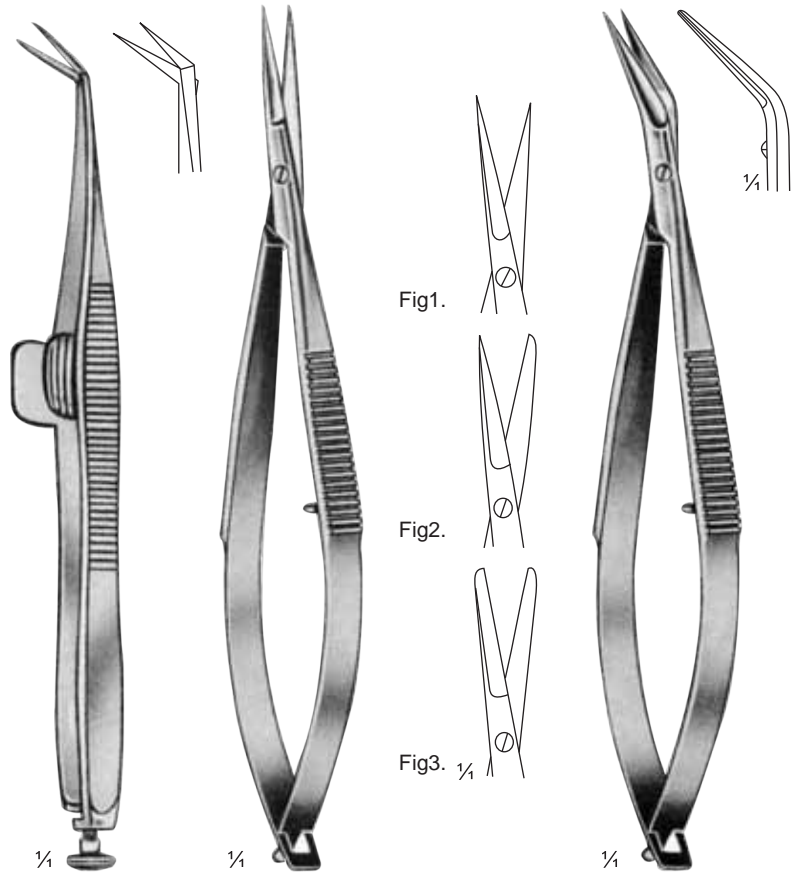

Wecker
06-832-11
11 cm / 4 1/4"

Noyes
12 cm / 4 3/4"

06-840-12
06-842-12
06-844-12

Fig.1 06-847-12
Fig.2 06-849-12
Fig.3 06-851-12

Dissecting Forceps, Tissue Forceps

Anatomische Pinzetten, Chirurgische Pinzetten
 Pinzas de disección, Pinzas de disección con diente

Pinces à dissection, Pinces à dissection à griffes
 Pinze per dissezione, Pinze per dissezione con denti

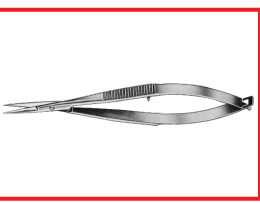

Standard
 07-002-10 - 07-002-16



07-002-10
 10.5 cm / 4 1/4"



07-002-11
 11.5 cm / 4 1/2"



07-002-13
 13 cm / 5"



07-002-14
 14.5 cm / 5 3/4"



07-002-16
 16 cm / 6 1/4"



Standard
 07-135-10 - 07-135-16
 1:2 Teeth



07-135-10
 10.5 cm / 4 1/4"



07-135-11
 11.5 cm / 4 1/2"



07-135-13
 13 cm / 5"



07-135-14
 14.5 cm / 5 3/4"



07-135-16
 16 cm / 6 1/4"

Micro Forceps

Mikropinzetten

Micro-Pinces

Micro Pinzas

Micro-Pinze

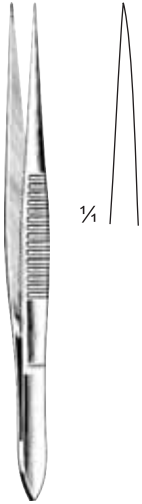

¼

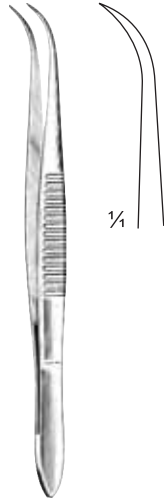

¼



¼

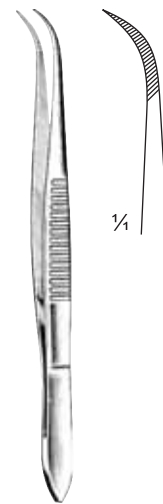

¼

07-366-09 = 9 cm / 3½" = 07-367-09
 07-366-10 = 10.5 cm / 4¼" = 07-367-10
 07-366-11 = 11.5 cm / 4½" = 07-367-11
 07-366-12 = 12.5 cm / 5" = 07-367-12
 smooth, without pin

07-368-08 = 8 cm / 3¼" = 07-369-08
 07-368-09 = 9 cm / 3½" = 07-369-09
 07-368-10 = 10.5 cm / 4¼" = 07-369-10
 07-368-11 = 11.5 cm / 4½" = 07-369-11
 07-368-12 = 12.5 cm / 5" = 07-369-12
 without pin



07-426-03
 No.3
 11.5 cm / 4½"



07-426-04
 No.4
 11 cm / 4¼"



07-426-05
 No.5
 11 cm / 4¼"

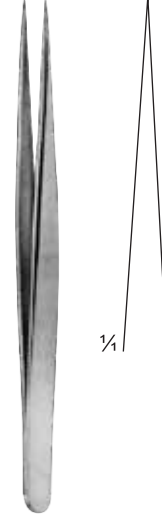

¼

07-428-07
 No.7
 13 cm / 5"

Splinter Forceps, Cover Glass Forceps

Splitterpinzetten, Deckglaspinzetten
Pinzas para espinas, Pinzas porta-laminillas

Pinces à échardes, Pinces porte-lamelles
Pinze per schegge, Pinze porta-lamelle

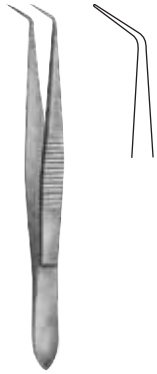

07-479-10
10 cm / 4"



07-480-10
10 cm / 4"



07-484-09
9 cm / 3½"
Cover Glass forceps



07-485-11
11 cm / 4¼"



Kuehne
07-486-10
10.5 cm / 4¼"
cover glass forceps



Kuehne
07-489-10
10.5 cm / 4¼"
cover glass forceps



Corent
07-492-11
11 cm / 4¼"
slide holding forceps



Corent
07-493-11
11 cm / 4¼"

Artery Forceps, Retractors

Arterienklemmen, Wundhaken
Pinzas hemostáticas, Separadores

Pinces hémostatiques, Ecarteurs
Pinze emostatiche, Divaricatori

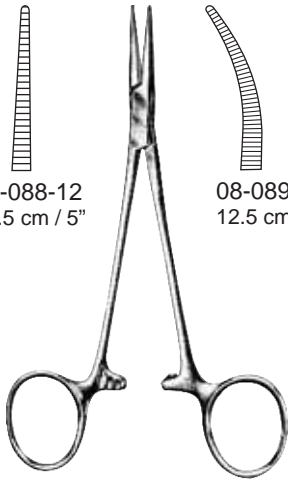
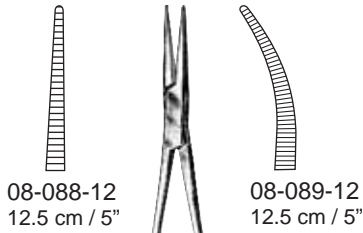

Halsted-Mosquito
08-088-12 - 08-089-12

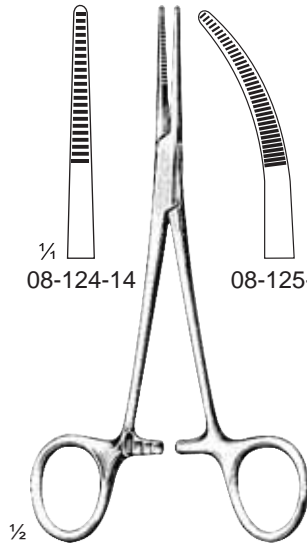
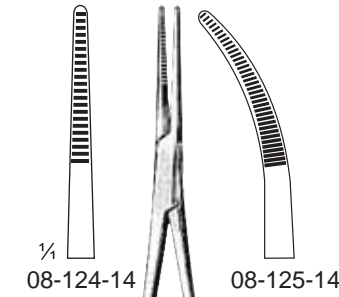

Kelly
08-124-14 - 08-125-14
14 cm / 5 1/2"

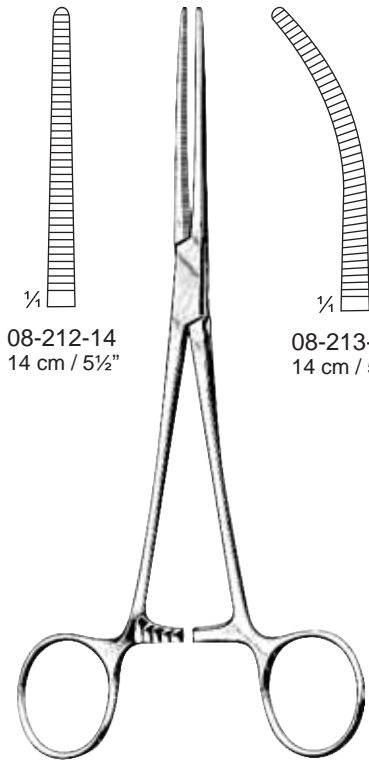
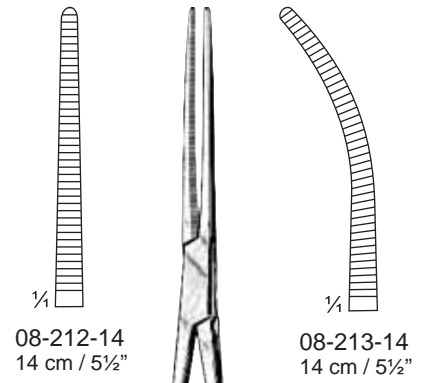

Pean (Rochester)
08-212-14 - 08-213-14

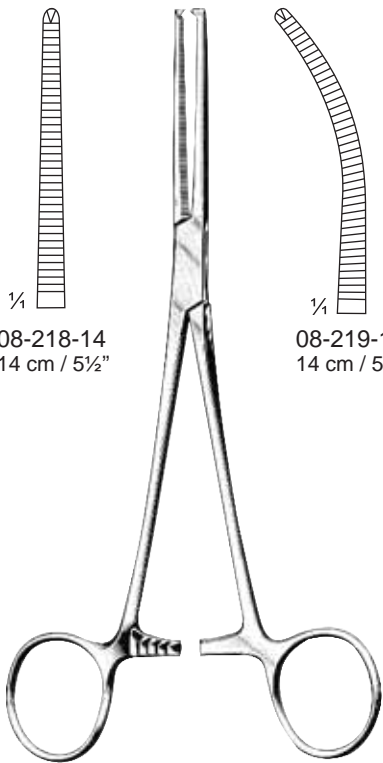
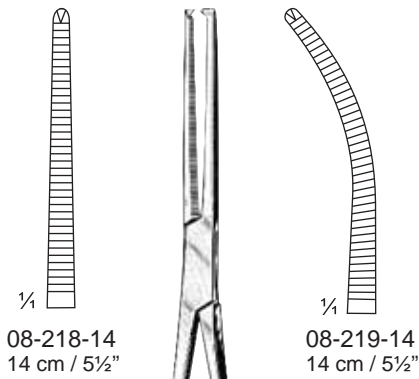

Kocher (Ochsner)
08-218-14 - 08-219-14
1:2 teeth



Finsen
10-085-16
16 cm / 6 1/4"
Sharp

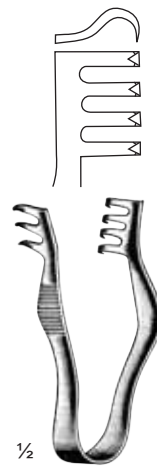

Weitlaner-Loktite
10-550-07
7 cm / 2 3/4"



Weitlaner-Loktite
10-550-10 - 10-551-10
10.5 cm / 4 1/4"

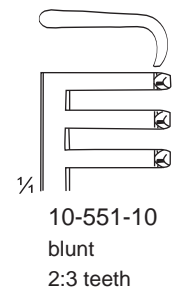
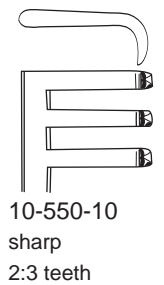

Probes, Measuring Instruments

Sonden, Messinstrumente
Sondas, Instrumentos para medidas

Sondes, Instruments pour mesurer
Sonde, Strumenti per misurare



11-004-11 = 11.5 cm / 4¼"
11-004-13 = 13 cm / 5"
11-004-14 = 14.5 cm / 5¾"
11-004-16 = 16 cm / 6¼"
11-004-18 = 18 cm / 7"
11-004-20 = 20 cm / 8"
11-004-25 = 25 cm / 9¾"
2 mm ø



11-010-13 = 13 cm / 5"
11-010-14 = 14.5 cm / 5¾"
11-010-16 = 16 cm / 6¼"
11-010-18 = 18 cm / 7"
11-010-20 = 20 cm / 8"
11-010-25 = 25 cm / 9¾"
2 mm ø (with eye)



11-024-11 = 11.5 cm / 4½"
11-024-13 = 13 cm / 5"
11-024-14 = 14.5 cm / 5¾"
11-024-16 = 16 cm / 6¼"
11-024-18 = 18 cm / 7"
11-024-20 = 20 cm / 8"

Tape Measure, graduated in centimeters and inches.

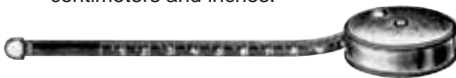

12-151-15
Linen
150 cm / 59"

12-151-20
Steel
200 cm / 78¾"



12-153-15 15 cm / 6"
12-153-20 20 cm / 8"
12-153-30 30.5 cm / 12"
12-153-50 50 cm / 19¾"



Magnifiers

12-155-01 1 folding single
12-155-02 2 folding twin

Needle Holders, Ligature Needles

Nadelhalter, Unterbindungsnadeln
Porta-agujas, Agujas para ligaduras

Porte-aiguilles, Aiguilles à ligatures
Portaghi, Aghi per legatura

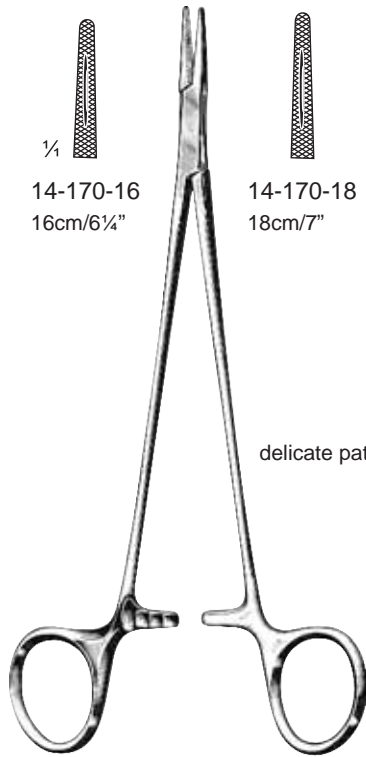
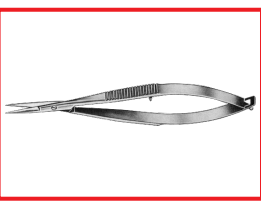

1/4
14-170-16
16cm/6 1/4"

14-170-18
18cm/7"

delicate pattern

Mayo-Hegar
14-170-16 - 14-170-18

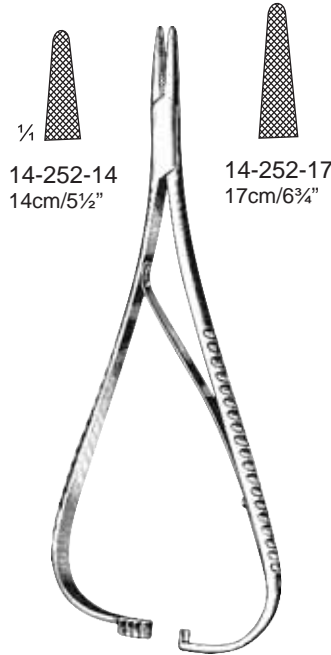

1/4
14-252-14
14cm/5 1/2"

14-252-17
17cm/6 3/4"

Mathieu
14-252-14 - 14-252-17

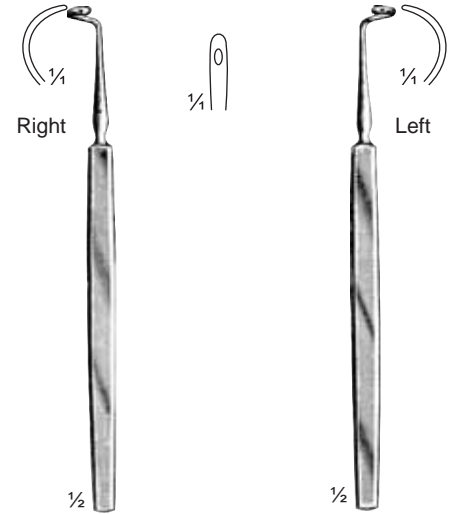

1/4
Right

1/4

1/4
Left

1/2
Kronecker
14-515-13
13 cm / 5"

1/2
Kronecker
14-517-13
13 cm / 5"

Bone Currettes
Scharfe Löffel
Cucharillas cortantes
Curettes tranchantes
Curette taglianti



00 0 1
1/4 0 1 2
25-300-00 25-300-01 25-300-12

1/2
Williger
25-300-00 - 25-300-12
13.5 cm / 5 1/4"

Periosteal Elevators
Raspatorien
Periostótomos
Rugines-raspatoires
Periostotomi

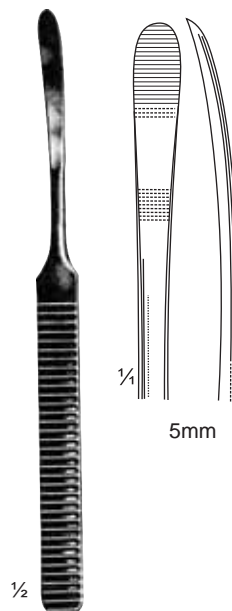

1/2
Williger
25-368-16
16 cm / 6 1/4"

Bone Rongeurs
Hohlmeißelzangen
Pinzas gubias
Pincas-gouges
Pinze-sgorbie

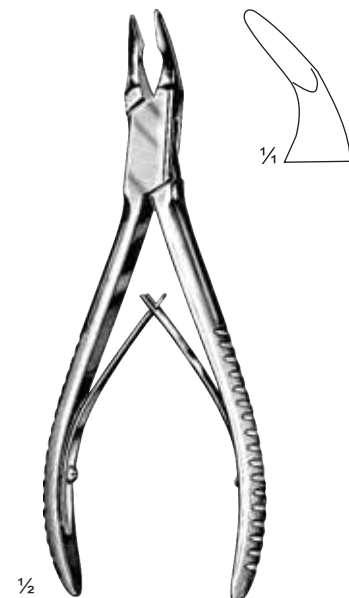

1/2
Blumenthal
25-857-15
15.5 cm / 6"

Wire Loops, Dissecting Needles

Drahtschlingen, Präpariernadein
Asas, Agujas para preparaciones

Anses, Alguilles à préparation
Anse, Aghi per preparazione



Dissecting Needles and Loops



23-015-18
18 cm / 7 1/8"



23-017-18
18 cm / 7 1/8"

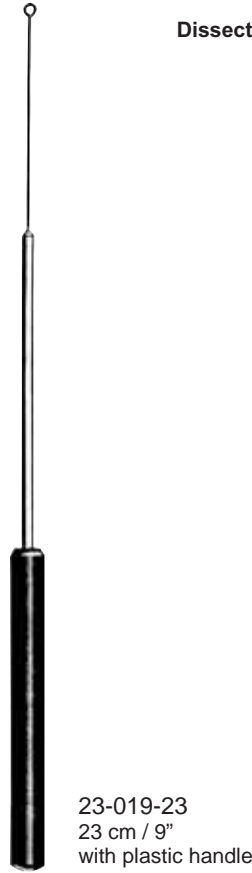

23-019-23
23 cm / 9"
with plastic handle



23-021-01 - 23-021-05
14 cm / 5 1/2"

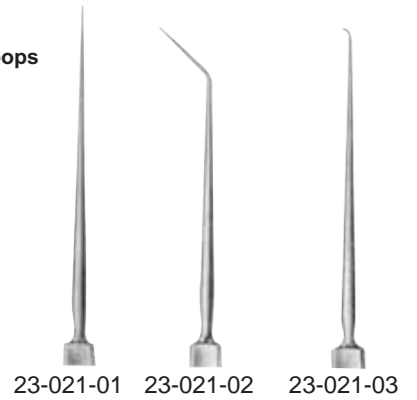

23-021-01 23-021-02 23-021-03



23-021-04 23-021-05

- 23-025-04
- 23-025-05
- 23-025-06
- 23-025-07

Dissecting Needles of metal
 ø 0.4mm x 40mm long
 ø 0.5mm x 40mm long
 ø 0.6mm x 40mm long
 ø 0.7mm x 40mm long

- 23-027-04
 - 23-027-05
 - 23-027-06
 - 23-027-07
- Dissecting Loop of C-metal
 ø 0.4mm x 40mm long
 ø 0.5mm x 40mm long
 ø 0.6mm x 40mm long
 ø 0.7mm x 40mm long



Kolle
23-028-13
13 cm / 5 1/8"



1/2
Kronecker
23-029-13
13 cm / 5 1/8"



1/2
Johns-Hopkin
23-030-15
15 cm / 6"



23-031-13
13 cm / 5 1/8"



23-033-13
13 cm / 5 1/8"



23-035-13
13 cm / 5 1/8"

Holder for Dissecting
Needles and loop

Spatulas

Spatel
Espátulas
Spatules
Spatole



Blow Pipes
Tubulus
Tubos
Tube
Tubo



22-011-00
23.5 cm / 9¼"
blow pipe

Extra Tip



22-011-01



22-011-02



22-012-01
15 cm / 6"
blow pipe

Muscle Retractors (Hooks)
Muskelhaken
Ecarteurs musculaires
Separadores (ganchos) musculares
Divaricatori (unicini) muscolari



22-067-06
6.5 cm / 2½"
Double Hook



22-069-03
Triple Chain Hook



23-042-00
Dermatograph, red



23-044-14
16 cm / 6¼"
Blade+14mm



23-046-10 Blade 10 mm
23-046-15 Blade 15 mm
23-046-20 Blade 20 mm

Section Lifter



23-047-00
metal D/ended



23-049-10
10 cm / 4"
Section Lifter aluminium

Dissecting sets

Anatomische bestecke
Estuches de disección

Trousse à dissection
Astuccio Completo



Wooden Case

- 23-100-00 Dissecting set in wooden case consisting of:
- 05-004-01 1 dissecting knife
- 06-025-13 1 Scissors, curved
- 07-368-10 1 Microscopic Forceps,
- 23-021-01 2 Dissecting Needles



Khaki Drill Pouch
21 x 33.5cm/8³/₄" x 13¹/₄"

- 23-102-00 Dissecting set In khaki drill pouch, consisting of
- 05-004-01 1 Dissecting Knife
- 05-005-01 1 Dissecting Knife
- 05-056-03 1 Dissecting Knife
- 05-004-03 1 Cartilage Knife
- 06-052-15 1 Scissors with probe-end, 13 cm / 5"
- 07-002-13 1 Dressing Forceps, 13 cm / 5"
- 22-069-03 1 Triple Chain Hook
- 22-012-01 1 Blow Pipe, double



Leather Pouch
with zip fastener and removable washable lining with loops and covering flaps for instruments
11.5 x 18.5cm / 4¹/₂" x 7¹/₄"

- 23-104-00 In Leather Pouch, consisting of
- 05-004-01 1 Dissecting Knife
- 05-005-01 1 Dissecting Knife
- 05-004-03 1 Cartilage Knife
- 06-052-13 1 Scissors with probe-end, 13 cm / 5"
- 07-002-03 1 Dressing Forceps, 13 cm / 5"
- 07-135-13 1 Tissue forceps, 13 cm / 5"
- 07-368-10 1 Microscopic Forceps, 10.5 cm / 4¹/₄"
- 11-010-03 1 Probe with eye, 13 cm / 5"
- 22-069-03 1 Dissecting Hook, double