



# 08

## HEMOSTATS

KLEMMEN  
PINZAS HEMOSTATICAS  
PINCES HEMOSTATIQUES  
PINZE EMOSTATICHE





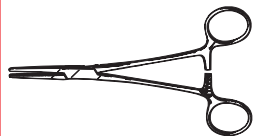

### Bulldog Clamps

Bulldogklemmen  
Clamps Bulldog

Clamps Bulldog  
Pinze Bulldog



Diethrich

08-002-08 - 08-003-12

	08-002-08	08-002-10	08-002-12	08-003-08	08-003-10	08-003-12
Length	50 mm	50 mm	60 mm	50 mm	50 mm	60 mm
Jaws	8 mm	12 mm	20 mm	8 mm	12 mm	20 mm
Weight	3 gr.	3 gr.	3 gr.	3 gr.	3 gr.	3 gr.
Pressure	50 gr.	50 gr.	50 gr.	50 gr.	50 gr.	50 gr.



Dieffenbach

08-010-03 - 08-011-06

08-010-03 3.5 cm / 1½"	08-010-05 5 cm / 2"	08-010-06 6 cm / 2¼"
08-011-03 3.5 cm / 1½"	08-011-05 5 cm / 2"	08-011-06 6 cm / 2¼"

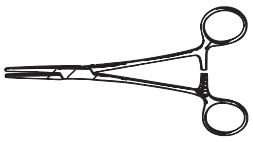

### Bulldog Clamps, Setting Forceps

Bulldogklemmen, Anlegezange  
Clamps Bulldog, Pinza para poner

Clamps Bulldog, Pince à poser  
Pinze Bulldog, Pinza per posizionare



08-020-04  
4 cm / 1½"



08-020-05  
5 cm / 2"



08-020-06  
6.5 cm / 2½"

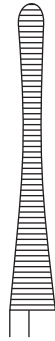

08-020-07  
7.5 cm / 3"



08-020-09  
9 cm / 3½"



½



08-021-04  
4 cm / 1½"



08-021-05  
5 cm / 2"

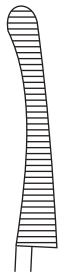

08-021-06  
6.5 cm / 2½"



08-021-07  
7.5 cm / 3"

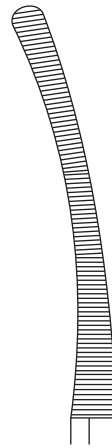

08-021-09  
9 cm / 3½"



Johns-Hopkins  
08-023-24  
24.5 cm / 9¾"

Johns-Hopkins

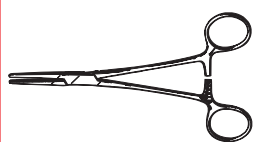

**Artery Forceps**

Arterienklemmen  
Pinzas hemostáticas

Pinces hémostatiques  
Pinze emostatiche

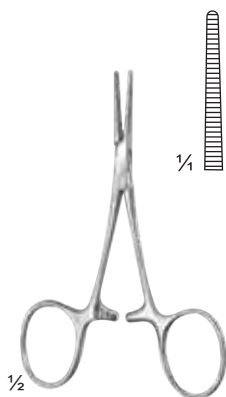

**Carrel**  
08-028-10  
10 cm / 4"

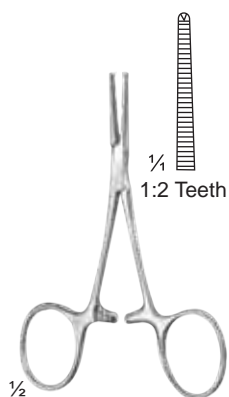

**Terrier**  
08-030-10  
10 cm / 4"

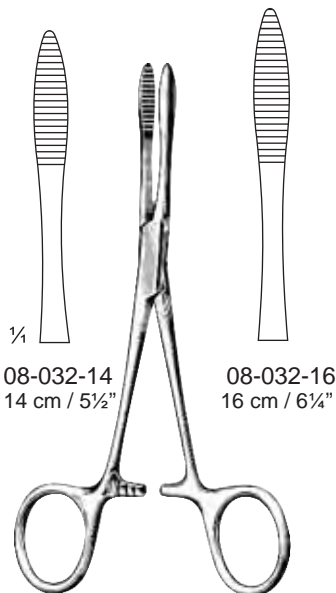

**Pean**  
08-032-14 - 08-032-16

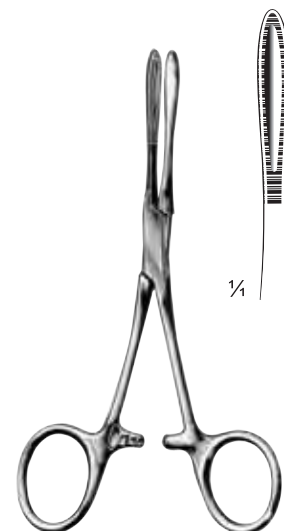

**Kroenlein**  
08-034-13  
13 cm / 5"



**Spencer-Wells**  
08-036-13 - 08-037-23

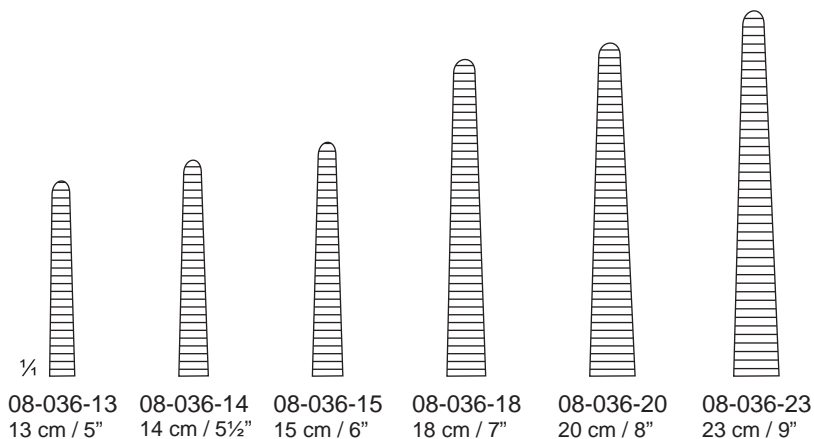

08-036-13 13 cm / 5"    08-036-14 14 cm / 5½"    08-036-15 15 cm / 6"    08-036-18 18 cm / 7"    08-036-20 20 cm / 8"    08-036-23 23 cm / 9"

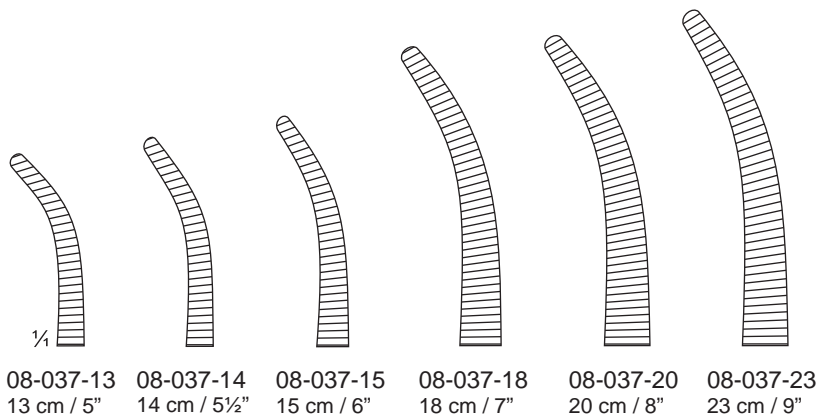

08-037-13 13 cm / 5"    08-037-14 14 cm / 5½"    08-037-15 15 cm / 6"    08-037-18 18 cm / 7"    08-037-20 20 cm / 8"    08-037-23 23 cm / 9"

**Seizing Forceps, Angiotribes**

Fasszangen, Druckklemmen

Pinces à saisir, Pinces-clamps à pression progressive

Pinzas para coger, Pinzas-clamps de presión progresiva

Pinze per afferrare, Pinze per pressione progressiva



**Chaput**  
08-042-13  
13 cm / 5"



**Tuffier**  
08-044-13  
13 cm / 5"

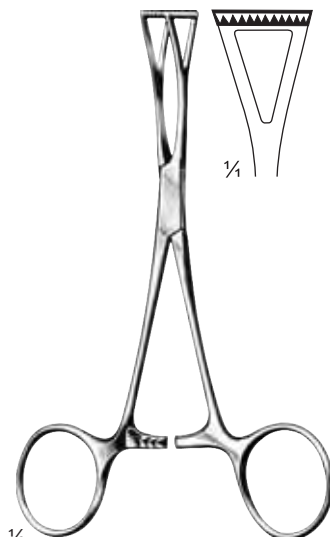

**Collin**  
08-046-14  
14 cm / 5 1/2"

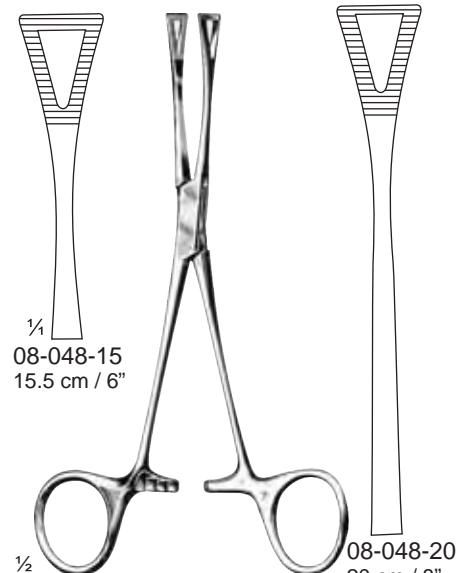

**Pennington**  
08-048-15 - 08-048-20

08-048-15  
15.5 cm / 6"

08-048-20  
20 cm / 8"



08-050-25 - 08-050-26



08-050-25  
25 cm / 9 3/4"

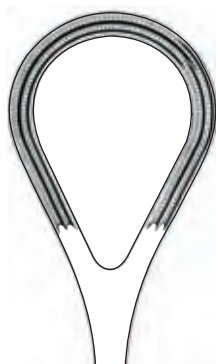

08-050-26  
26 cm / 10 1/4"

**ATRAUMA**



**Collin**  
08-052-17  
17 cm / 6 3/4"

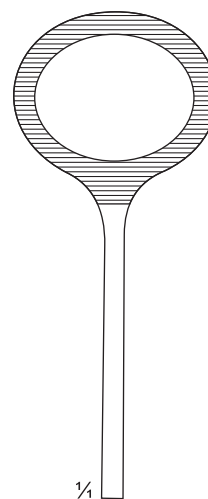

1/4"

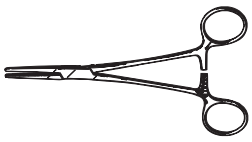

### Blood Vessel Clamps ,Scalp Flap Forceps

Gefäßklemme, Kopfhautklemmen

Pinces vasculaire, Pinces hémostatiques pour le cuir chevelu

Clamps para vasos, Pinzas hemostáticas para pericráneo

Pinza per vasi, Pinze emostatiche per il cuoio capelluto



**Martel**  
08-060-14  
14 cm / 5½"

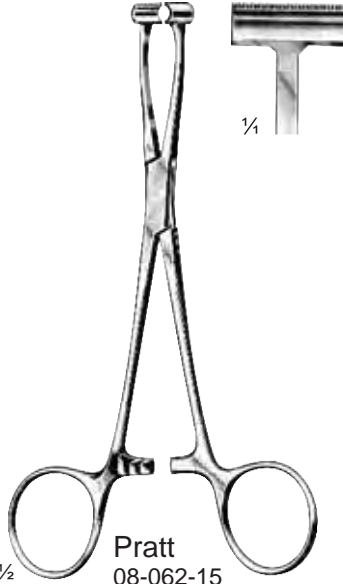

**Pratt**  
08-062-15  
15 cm / 6"

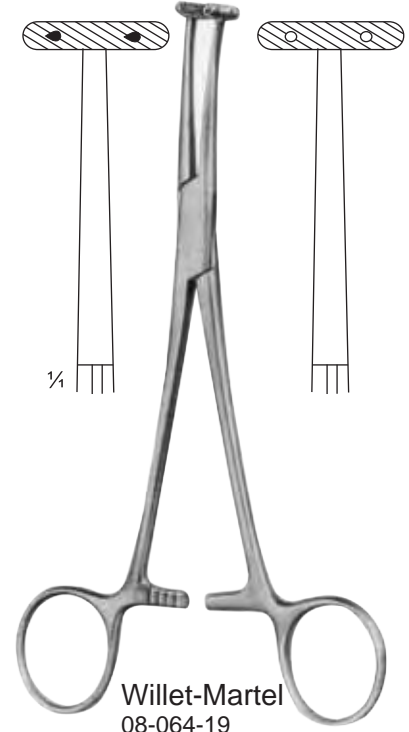
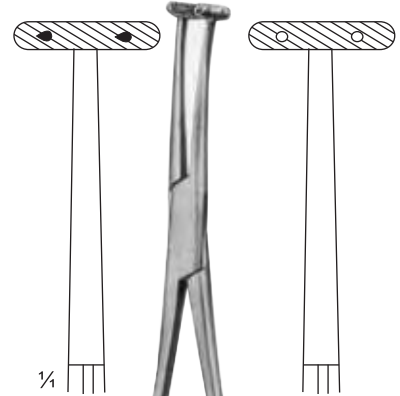

**Willet-Martel**  
08-064-19  
19 cm / 7½"

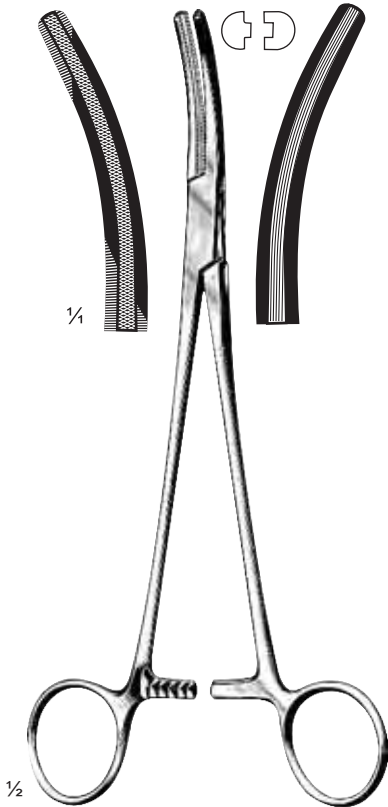
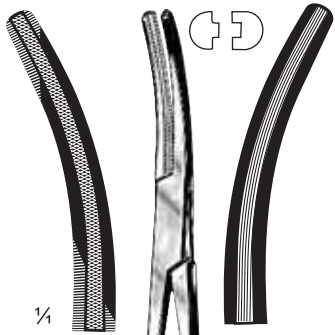

**Buie**  
08-067-21  
21 cm / 8¼"

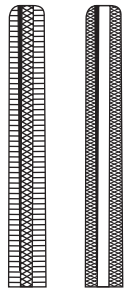

08-070-16  
16 cm / 6¼"

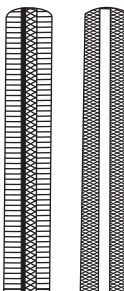

08-070-20  
20 cm / 8"

#### Angiotribes Haemorrhoidal Forceps



**Fergusson**  
08-070-16 - 08-071-20

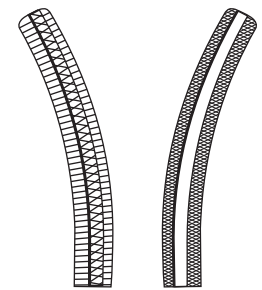

08-071-16  
16 cm / 6¼"

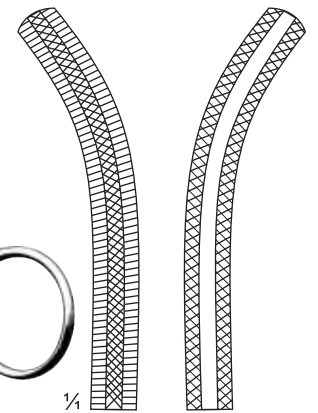

08-071-20  
20 cm / 8"

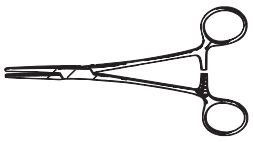

**Artery Forceps**

Arterienklemmen  
Pinzas hemostáticas

Pinces hémostatiques  
Pinze emostatiche

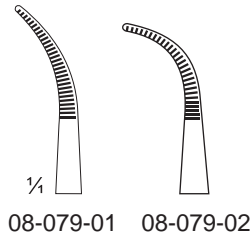

08-079-01 08-079-02

1/2

**Baby-Mixer**  
08-079-01 - 08-079-02  
14 cm / 5 1/2"

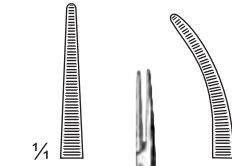
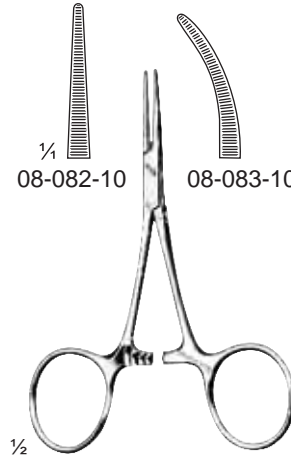

08-082-10 08-083-10

1/2

**Hartmann**  
08-082-10 - 08-083-10  
10 cm / 4"

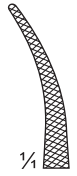
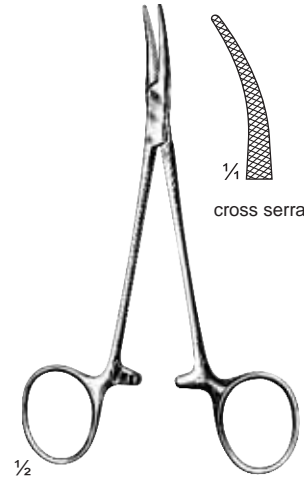

cross serrations

1/2

08-085-12  
12 cm / 4 3/4"

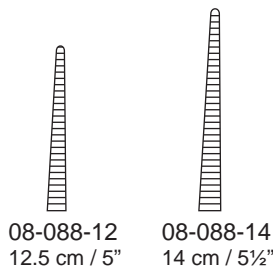

08-088-12 08-088-14  
12.5 cm / 5" 14 cm / 5 1/2"

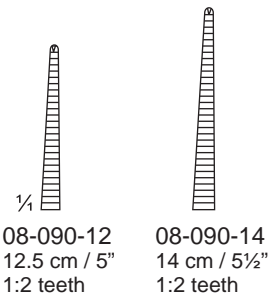

08-090-12 08-090-14  
12.5 cm / 5" 14 cm / 5 1/2"  
1:2 teeth 1:2 teeth



**Halsted-Mosquito**  
08-088-12 - 08-091-14

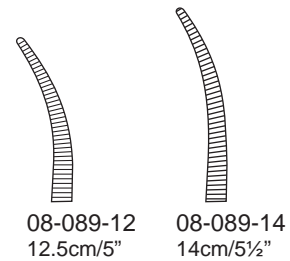

08-089-12 08-089-14  
12.5cm/5" 14cm/5 1/2"

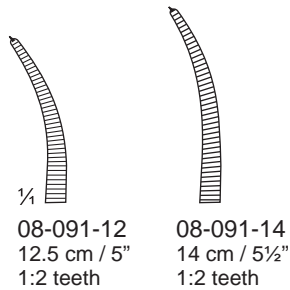

08-091-12 08-091-14  
12.5 cm / 5" 14 cm / 5 1/2"  
1:2 teeth 1:2 teeth



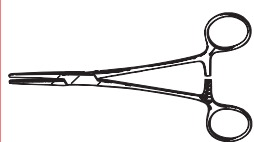



### Artery Forceps

Arterienklemmen  
Pinzas hemostáticas

Pinces hémostatiques  
Pinze emostatiche

  
08-100-10  
10 cm / 4"

  
08-100-12  
12 cm / 4¾"

  
08-102-10  
10 cm / 4"  
1:2 teeth

  
08-102-12  
12 cm / 4¾"  
1:2 teeth

  
08-101-10  
10 cm / 4"  
¼

  
08-101-12  
12 cm / 4¾"





**Micro-Mosquito**  
08-100-10 - 08-103-12

  
08-103-10  
10 cm / 4"  
1:2 teeth

  
08-103-12  
12 cm / 4¾"  
1:2 teeth

  
08-106-18  
18 cm / 7"

  
08-107-18  
18 cm / 7"

  
08-108-18  
18 cm / 7"  
1:2 Teeth

  
08-109-18  
18 cm / 7"  
1:2 Teeth

  
08-106-21  
21 cm / 8¼"

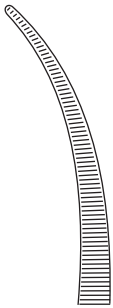
  
08-107-21  
21 cm / 8¼"



**Halsted-Mosquito**  
08-106-18 - 08-109-21

  
08-108-21  
21 cm / 8¼"  
1:2 Teeth

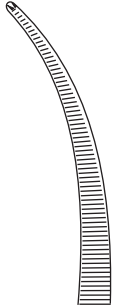
  
08-109-21  
21 cm / 8¼"  
1:2 Teeth

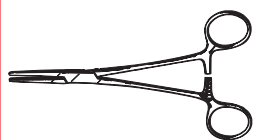

### Artery Forceps

Arterienklemmen  
Pinzas hemostáticas

Pinces hémostatiques  
Pinze emostatiche

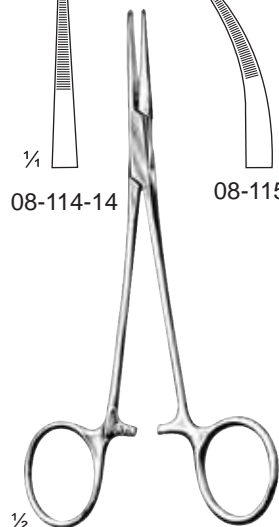
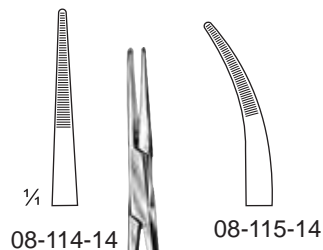

**Providence-Hospital**  
08-114-14 - 08-115-14  
14 cm / 5 1/2"

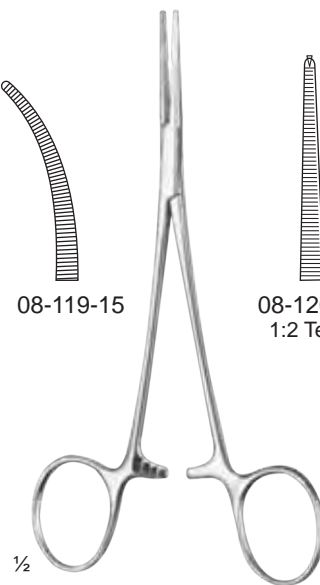
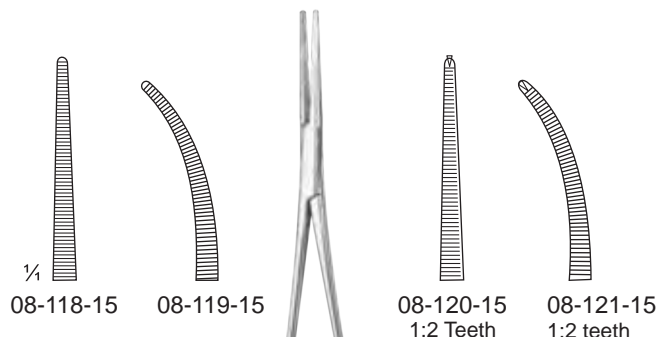

**Leriche**  
08-118-15 - 08-121-15  
15 cm / 6"

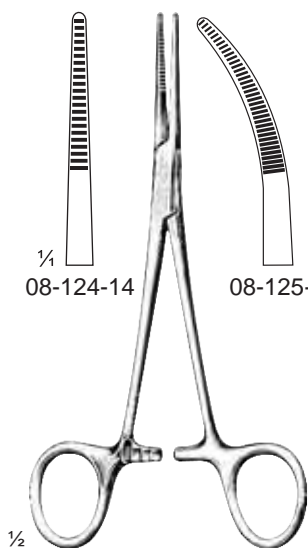
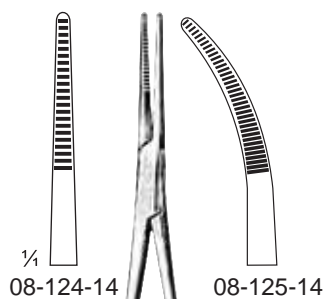

**Kelly**  
08-124-14 - 08-125-14  
14 cm / 5 1/2"

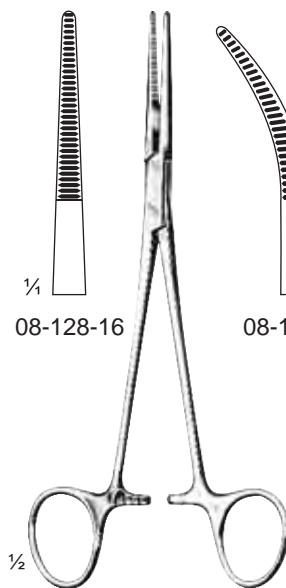
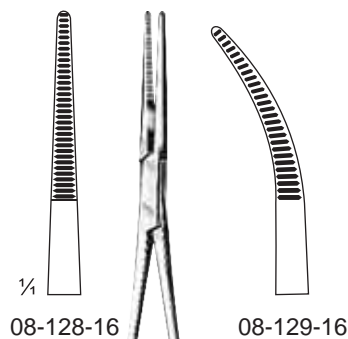

**Kelly-Rankin**  
08-128-16 - 08-129-16  
16 cm / 6 1/4"

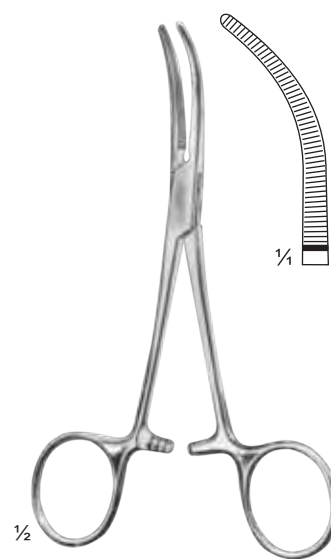

**Baby-Overholt**  
08-131-14  
14 cm / 5 1/2"

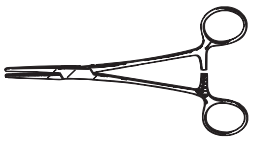

### Artery Forceps, Scalp Flap Forceps

Arterienklemmen, Kopfhautklemmen

Pinces hémostatiques, Pinces hémostatiques pour le cuir chevelu

Pinzas hemostáticas, Pinzas hemostáticas para pericráneo

Pinze emostatiche, Pinze emostatiche per il cuoio capelluto

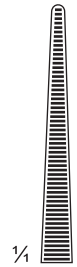

1/4  
08-136-14



08-137-14



1/4  
08-138-14  
1:2 Teeth



08-139-14  
1:2 Teeth

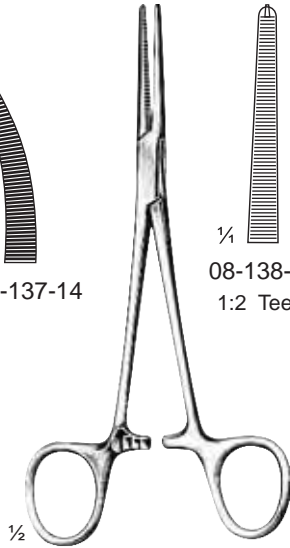

1/2

**Crile**  
08-136-14 - 08-139-14  
14 cm / 5 1/2"

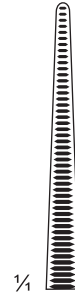

1/4  
08-142-16

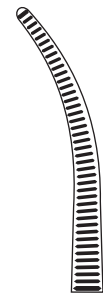

08-143-16

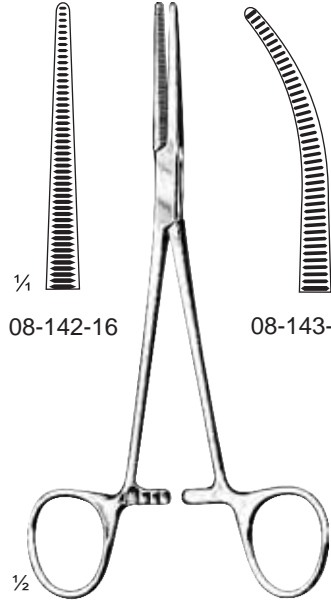

1/2

**Crile-Rankin**  
08-142-16 - 08-143-16  
16 cm / 6 1/4"

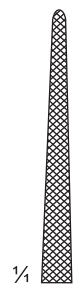

1/4  
08-146-15



08-148-15  
1:2 Teeth

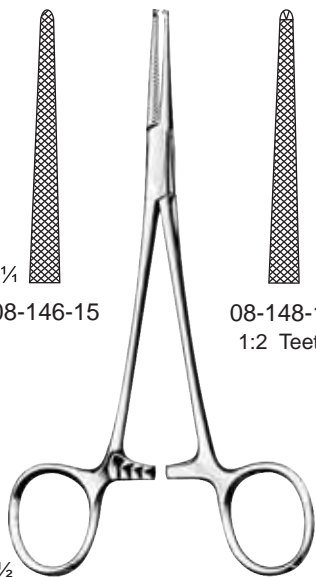

1/2

**Lovelace**  
08-146-15 - 08-148-15  
15.5 cm / 6"



1/4

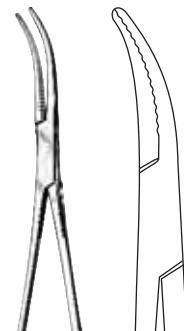

1/2

**Mosquito-Dandy**  
08-151-12  
12 cm / 4 3/4"

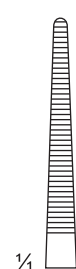

1/4  
08-155-14

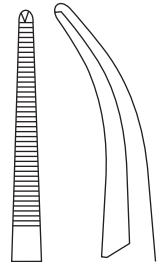

08-157-14  
1:2 Teeth

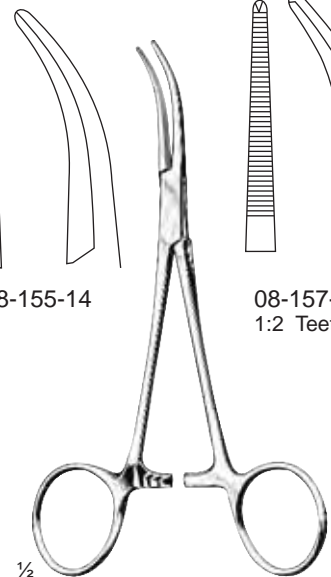

1/2

**Dandy**  
08-155-14 - 08-157-14  
14 cm / 5 1/2"

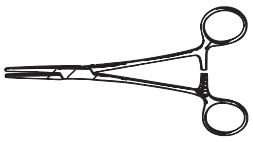

### Tonsil Hemostatic Forceps, Artery Forceps

Tonsillenklemmen, Arterienklemmen

Pinces hémostatiques pour amygdales, Pinces hémostatiques

Pinzas hemostáticas para amígdalas, Pinzas hemostáticas

Pinze emostatiche per tonsille, Pinze emostatiche



1/4  
08-163-18  
18 cm / 7"

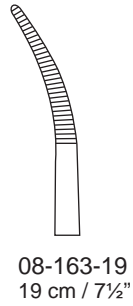

08-163-19  
19 cm / 7 1/2"

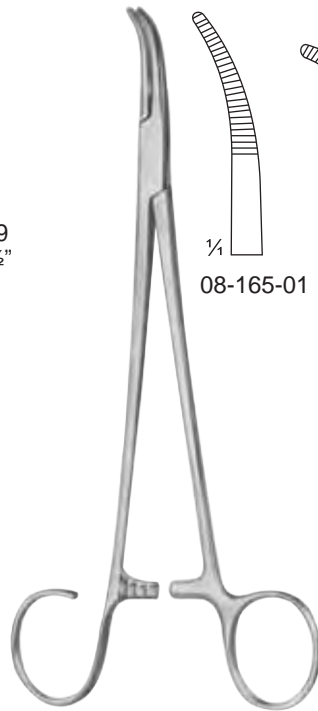

1/4  
08-165-01 08-165-02

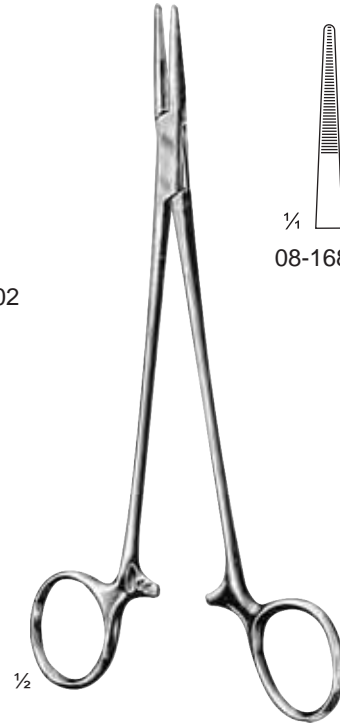

1/4  
08-168-18 08-169-18

**Schnidt-Sawtell**  
08-163-18 - 08-163-19

**Schnidt-Sawtell**  
08-165-01 - 08-165-02  
19 cm / 7 1/2"

**Adson**  
08-168-18 - 08-169-18  
18.5 cm / 7 1/4"

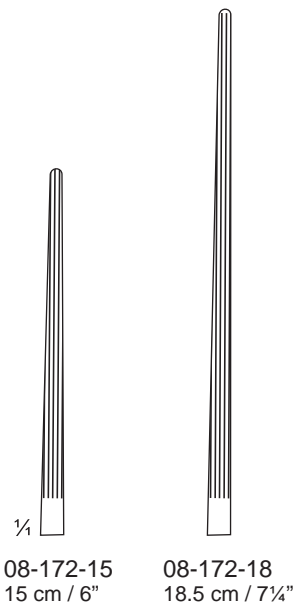

1/4  
08-172-15  
15 cm / 6"

08-172-18  
18.5 cm / 7 1/4"



**Bainbridge**  
08-172-15 - 08-173-18

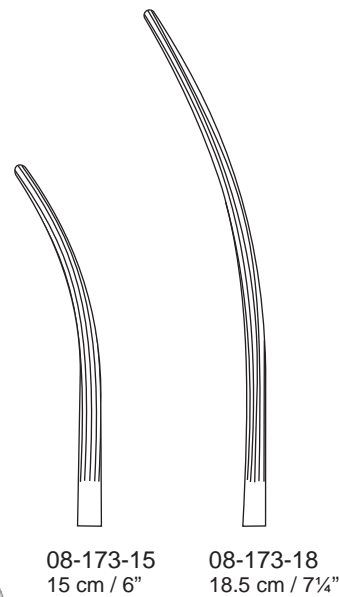

08-173-15  
15 cm / 6"

08-173-18  
18.5 cm / 7 1/4"

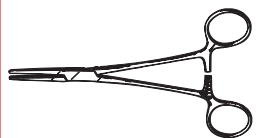

### Artery Forceps

Arterienklemmen  
Pinzas hemostáticas

Pinces hémostatiques  
Pinze emostatiche

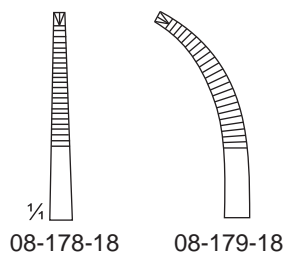
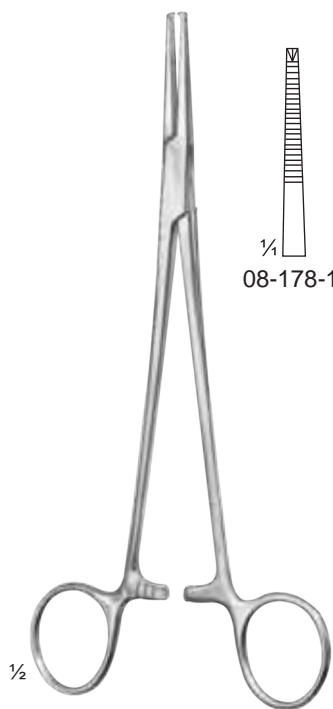

**Adson**  
08-178-18 - 08-179-18  
18.5 cm / 7 1/4"  
1:2 teeth

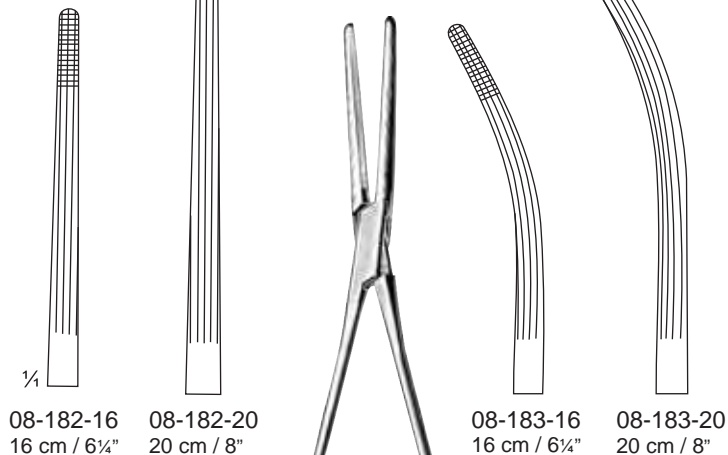
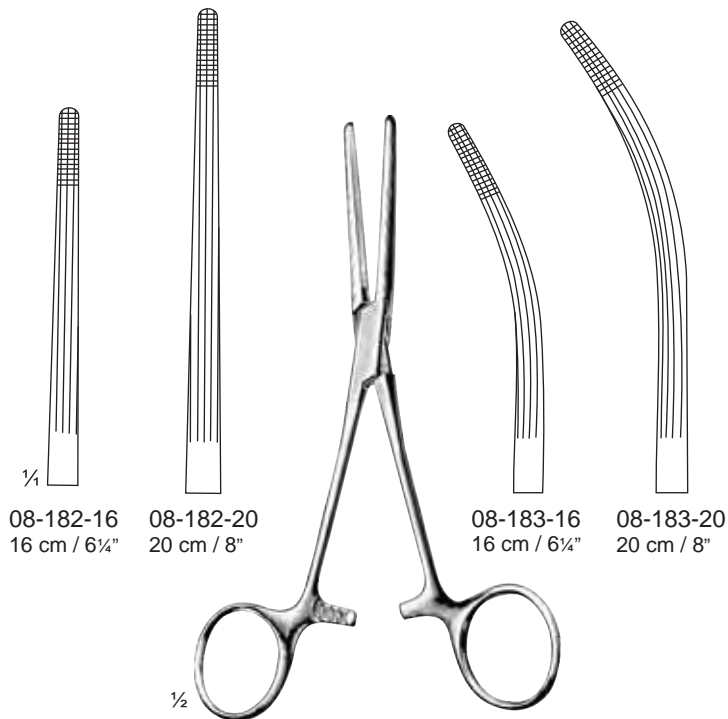

**Rochester-Carmalt**  
08-182-16 - 08-183-20

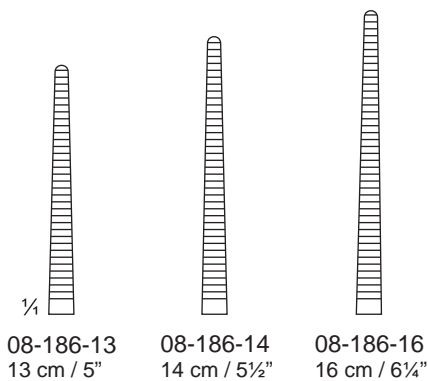

**Pean**  
08-186-13 - 08-187-16  
Delicate pattern

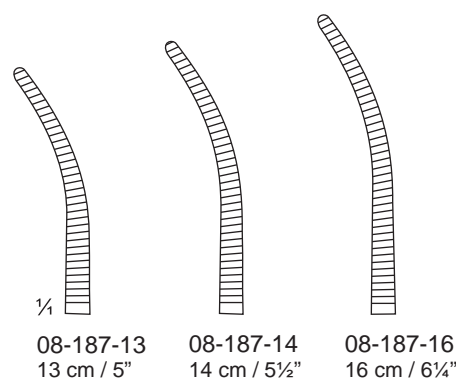

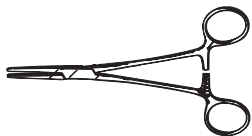

### Artery Forceps

Arterienklemmen  
Pinzas hemostáticas

Pinces hémostatiques  
Pinze emostatiche

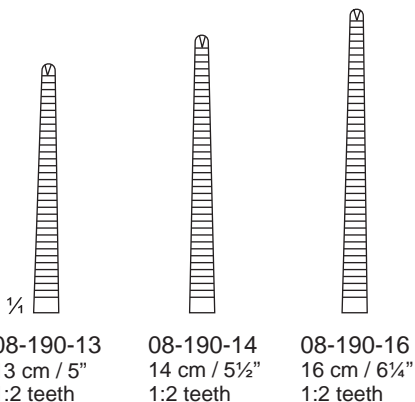

08-190-13  
13 cm / 5"  
1:2 teeth

08-190-14  
14 cm / 5½"  
1:2 teeth

08-190-16  
16 cm / 6¼"  
1:2 teeth

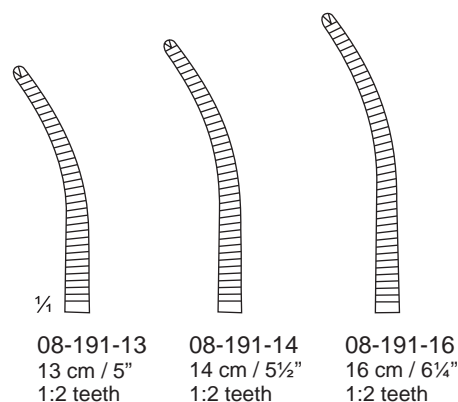

08-191-13  
13 cm / 5"  
1:2 teeth

08-191-14  
14 cm / 5½"  
1:2 teeth

08-191-16  
16 cm / 6¼"  
1:2 teeth



**Kocher**  
08-190-13 - 08-191-16  
Delicate pattern

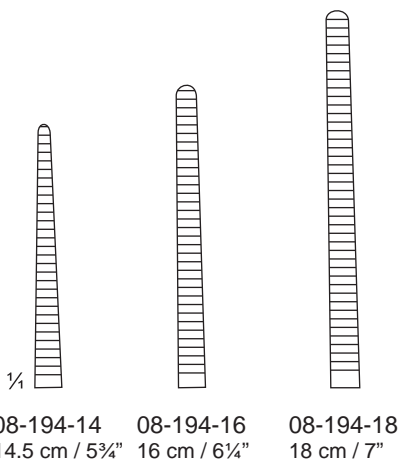

08-194-14  
14.5 cm / 5¾"  
1:2 teeth

08-194-16  
16 cm / 6¼"  
1:2 teeth

08-194-18  
18 cm / 7"  
1:2 teeth

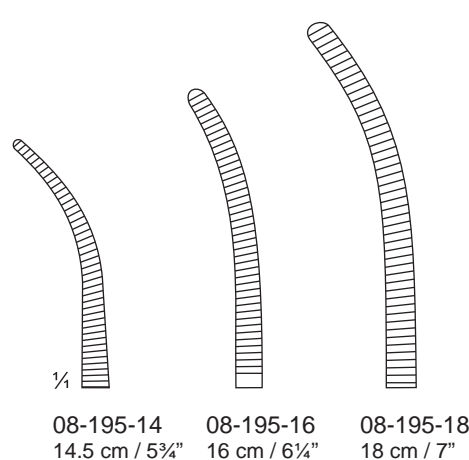

08-195-14  
14.5 cm / 5¾"  
1:2 teeth

08-195-16  
16 cm / 6¼"  
1:2 teeth

08-195-18  
18 cm / 7"  
1:2 teeth



**Pean-Nippon**  
08-194-14 - 08-195-18

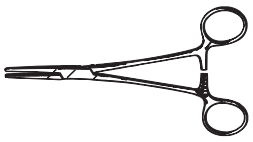

**Artery Forceps**

Arterienklemmen  
Pinzas hemostáticas

Pinces hémostatiques  
Pinze emostatiche

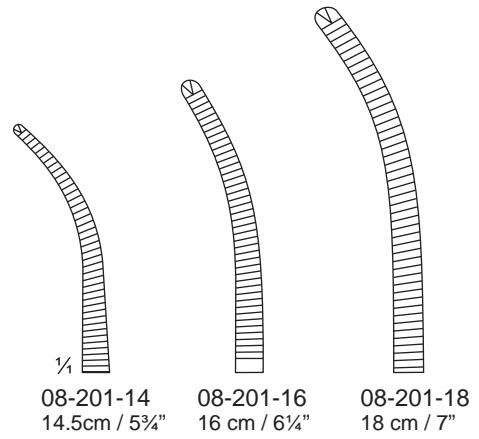
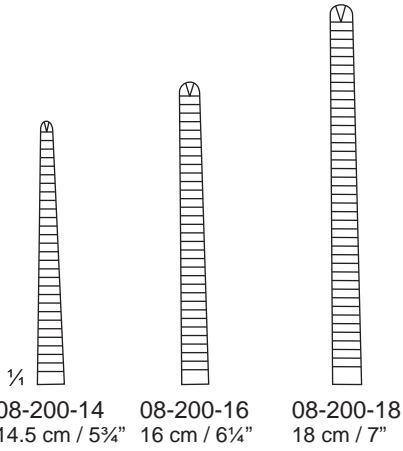

**Kocher-Nippon**  
08-200-14 - 08-201-18  
1:2 Teeth

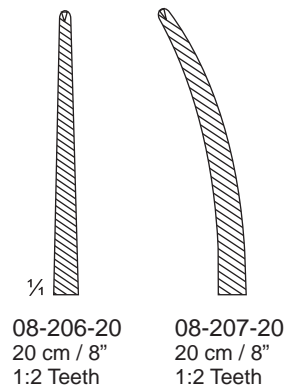
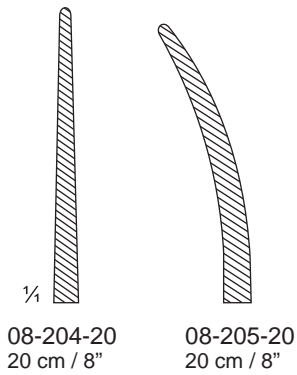

**Bengolea**  
08-204-20 - 08-207-26

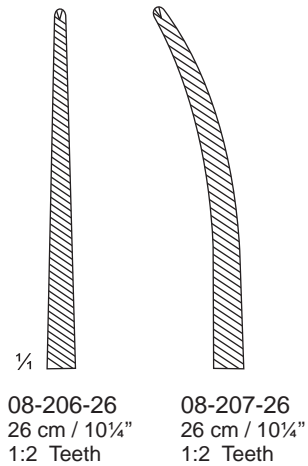
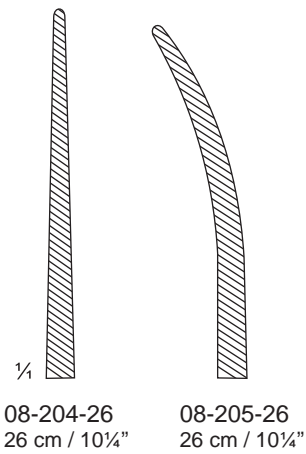

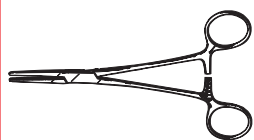

**Artery Forceps**

Arterienklemmen  
Pinzas hemostáticas

Pinces hémostatiques  
Pinze emostatiche



08-212-14  
14 cm / 5½"



08-212-16  
16 cm / 6¼"



08-212-18  
18 cm / 7"



08-212-20  
20 cm / 8"

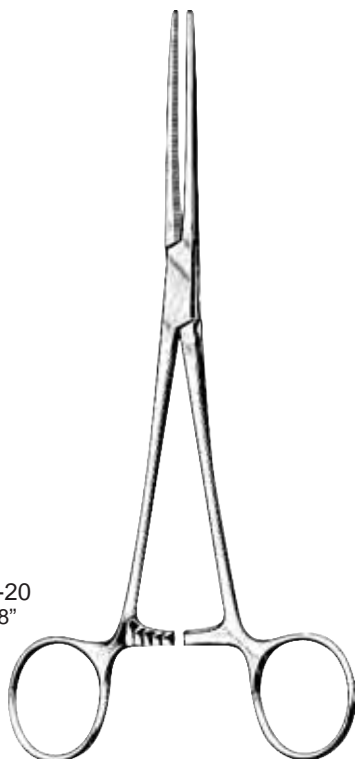

**Pean (Rochester)**  
08-212-14 - 08-213-30



08-212-22  
22 cm / 8¾"



08-212-24  
24 cm / 9½"



08-212-26  
26 cm / 10¼"



08-212-30  
30 cm / 11¼"

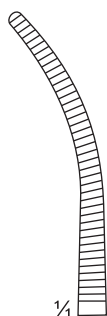

08-213-14  
14 cm / 5½"

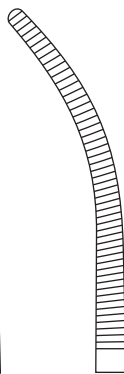

08-213-16  
16 cm / 6¼"

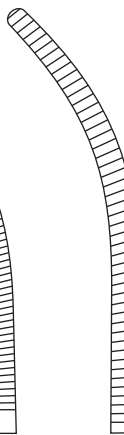

08-213-18  
18 cm / 7"

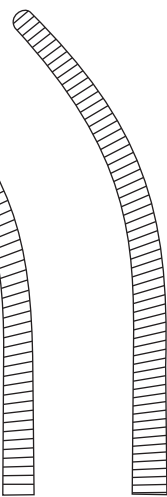

08-213-20  
20 cm / 8"

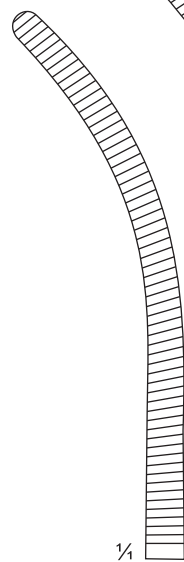

08-213-22  
22 cm / 8¾"

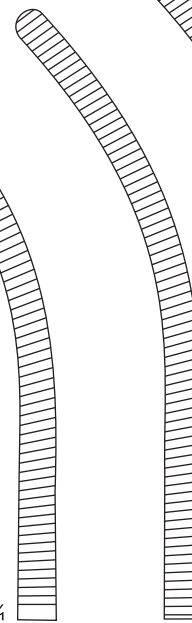

08-213-24  
24 cm / 9½"

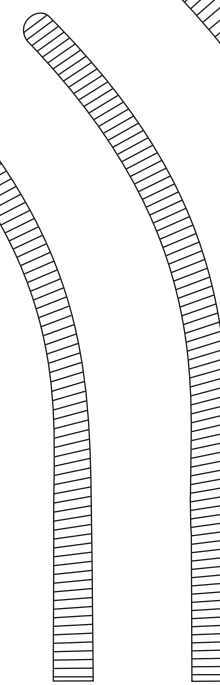

08-213-26  
26 cm / 10¼"

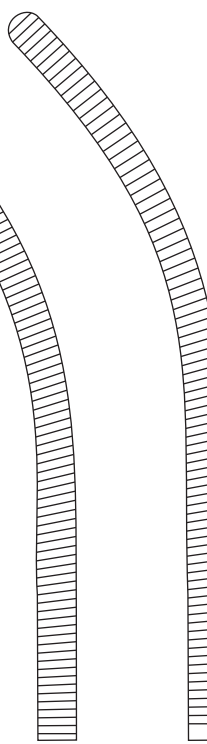

08-213-30  
30 cm / 11¼"



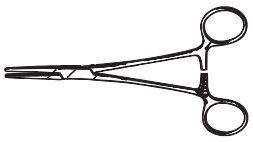

**Artery Forceps**

Arterienklemmen  
Pinzas hemostáticas

Pinces hémostatiques  
Pinze emostatiche

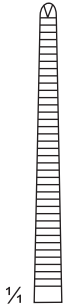

08-218-14  
14 cm / 5½"



08-218-16  
16 cm / 6¼"



08-218-18  
18 cm / 7"



08-218-20  
20 cm / 8"

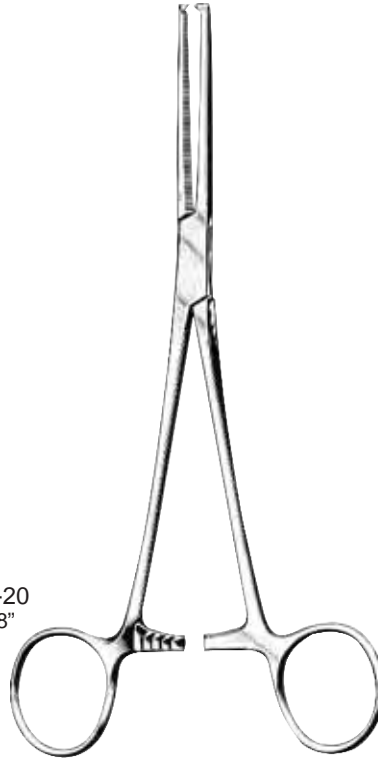

**Kocher (Ochsner)**  
08-218-14 - 08-219-30  
1:2 teeth



08-218-22  
22 cm / 8¾"



08-218-24  
24 cm / 9½"



08-218-26  
26 cm / 10¼"



08-218-30  
30 cm / 11¾"

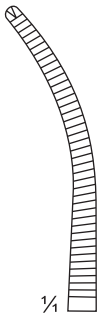

08-219-14  
14 cm / 5½"

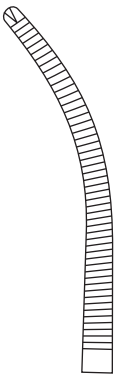

08-219-16  
16 cm / 6¼"

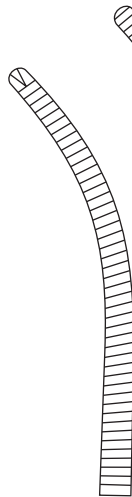

08-219-18  
18 cm / 7"

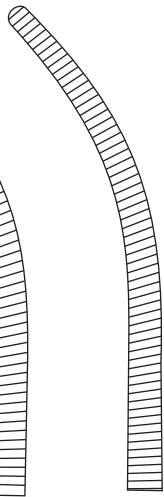

08-219-20  
20 cm / 8"

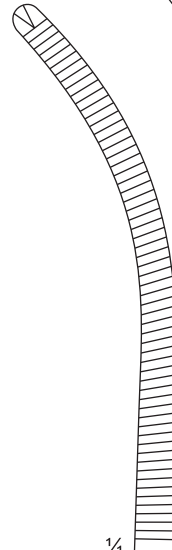

08-219-22  
22 cm / 8¾"

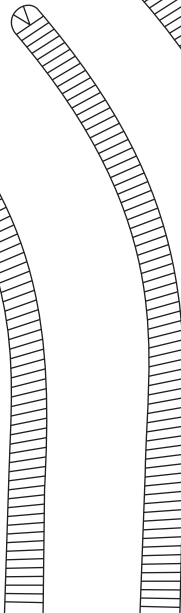

08-219-24  
24 cm / 9½"

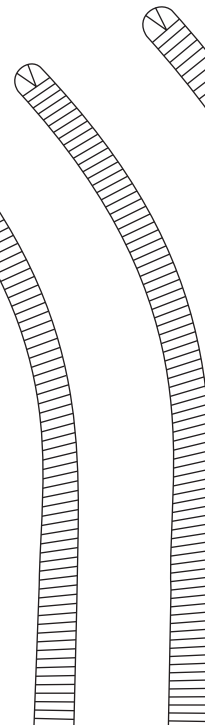

08-219-26  
26 cm / 10¼"

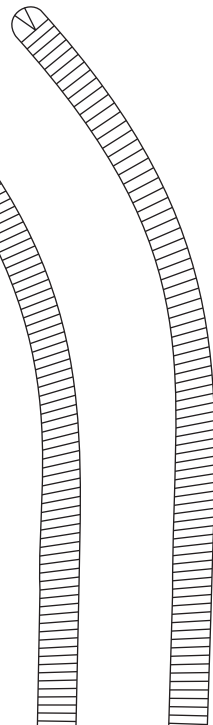

08-219-30  
30 cm / 11¾"

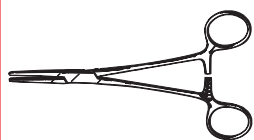

**Artery Forceps**

Arterienklemmen  
Pinzas hemostáticas

Pinces hémostatiques  
Pinze emostatiche

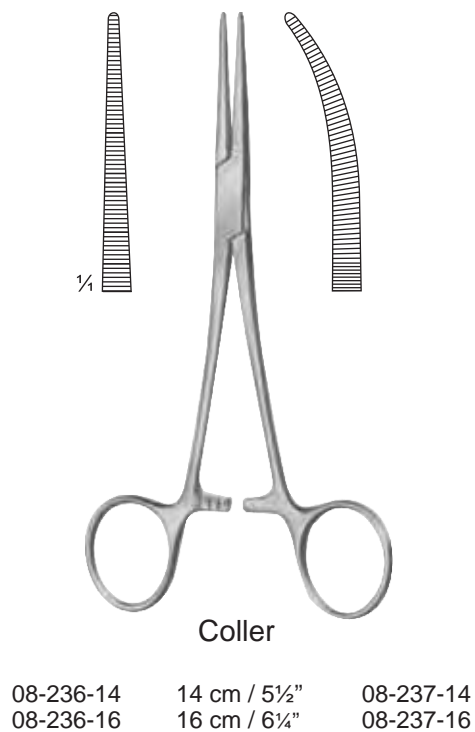
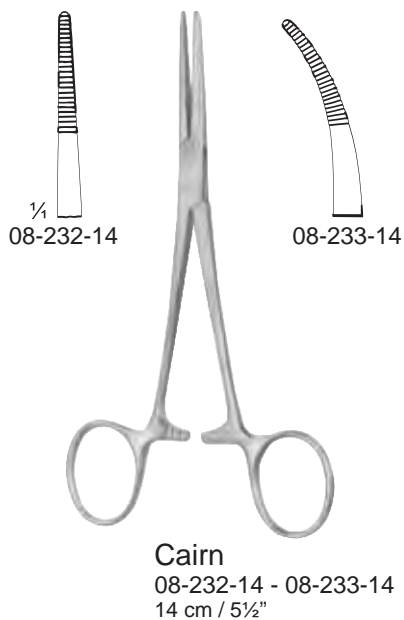
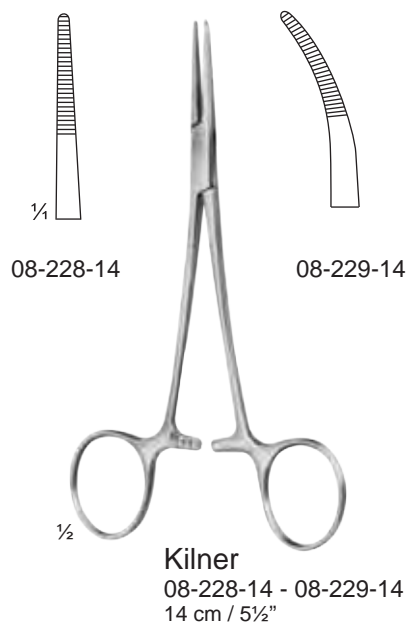
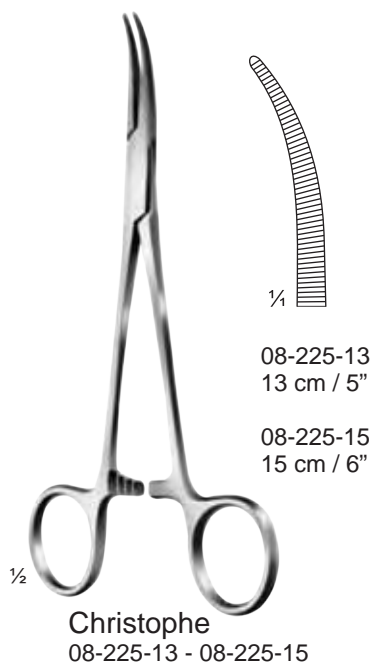

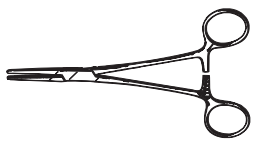

**Artery Forceps**

Arterienklemmen  
Pinzas hemostáticas

Pinces hémostatiques  
Pinze emostatiche

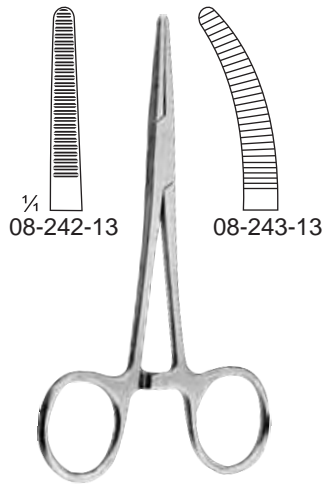

**Dunhill**  
08-242-13 - 08-243-13  
13 cm / 5"

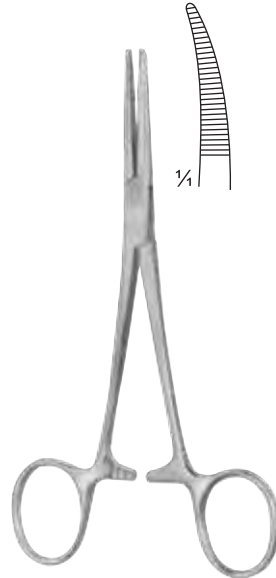

**Moynihan**  
08-245-15 = 15 cm / 6"  
08-245-18 = 18 cm / 7"

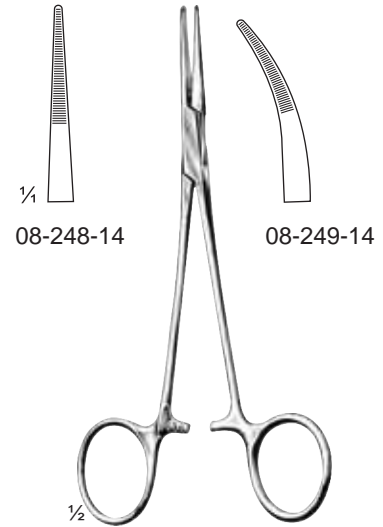

**Cushing**  
08-248-14 - 08-249-14  
14.5 cm / 5 3/4"



**Spencer-Wells**  
08-252-13 - 08-253-30

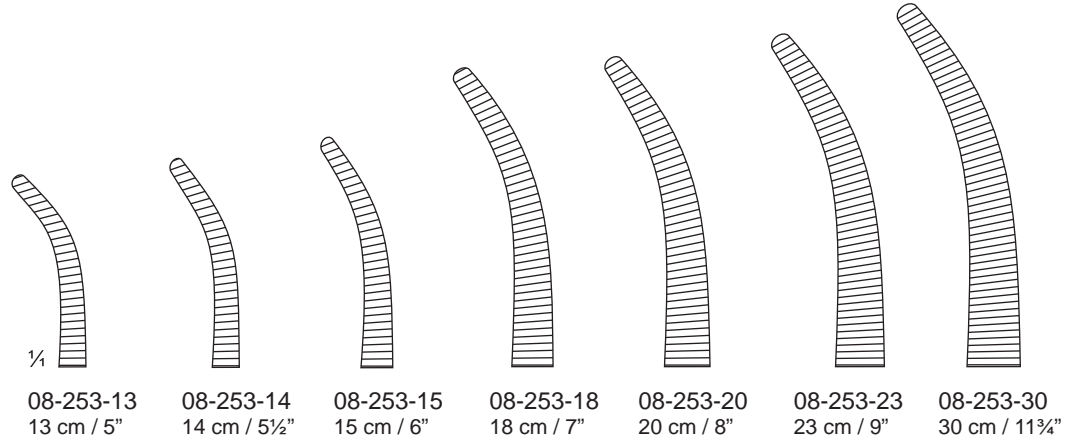
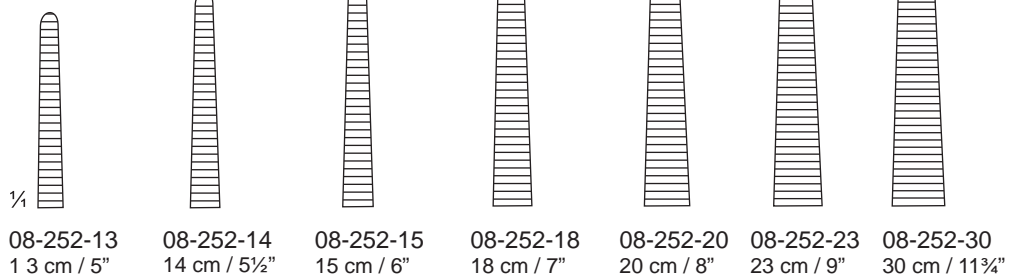

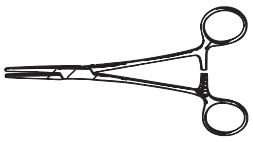

**Artery Forceps**

Arterienklemmen  
Pinzas hemostáticas

Pinces hémostatiques  
Pinze emostatiche

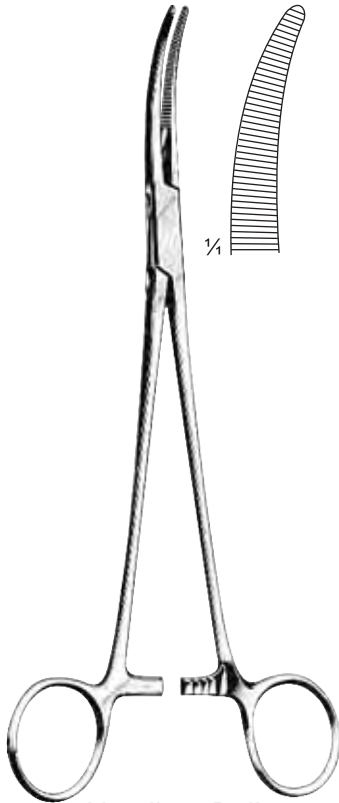

**Hamilton-Bailey**  
08-259-18  
18 cm / 7"

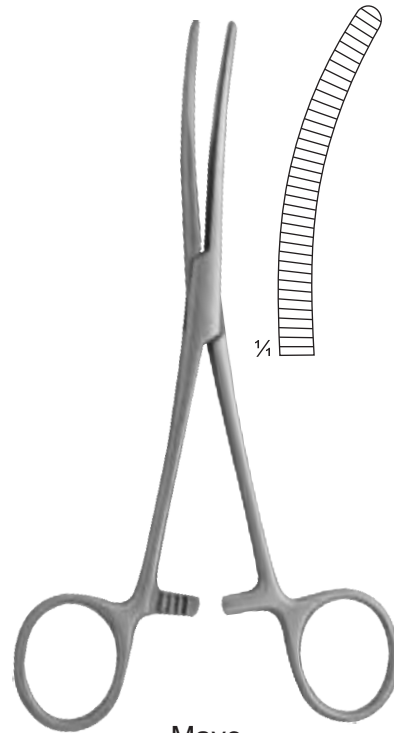

**Mayo**  
08-262-16  
16.5 cm / 6½"

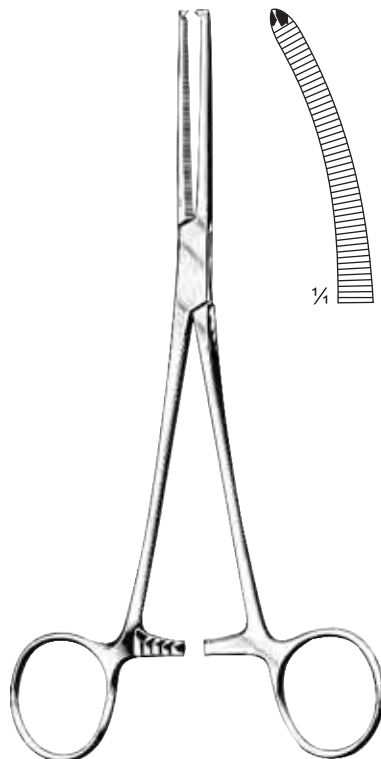

**Mayo-Ochsner**  
08-264-19  
19 cm / 7½"

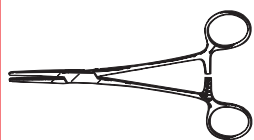

**Artery Forceps**

Arterienklemmen  
Pinzas hemostáticas

Pinces hémostatiques  
Pinze emostatiche

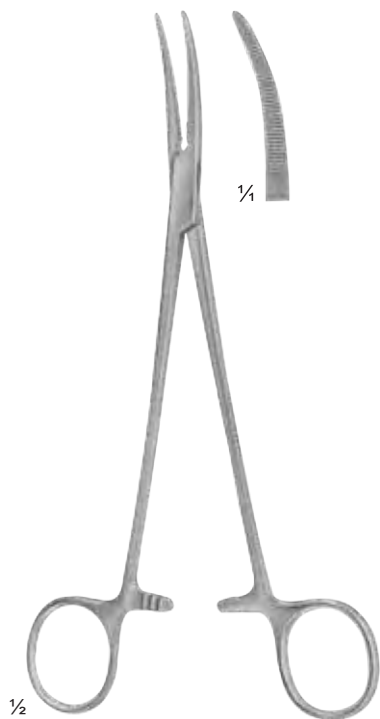

**Fuchsig**  
08-270-19  
19 cm / 7½"

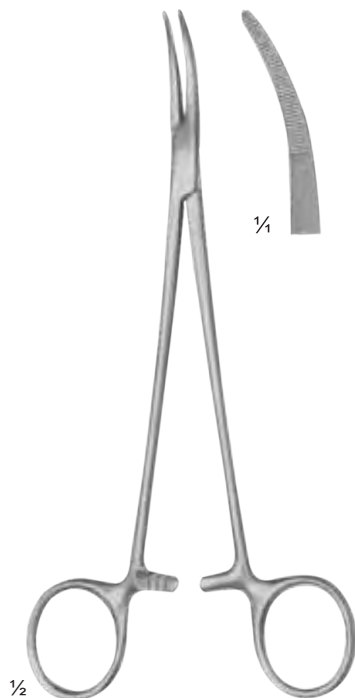

**Nissen**  
08-273-18  
18.5 cm / 7¼"

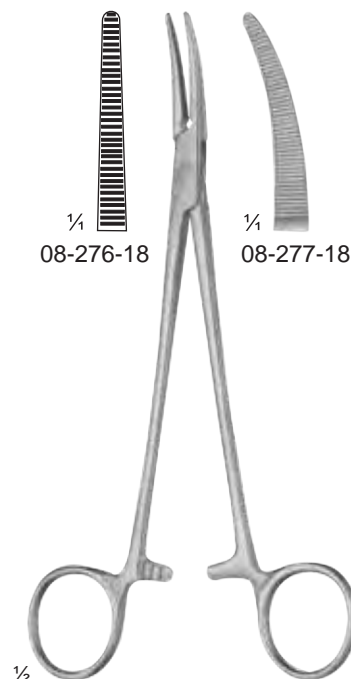

**Fraser-kelly (Crile)**  
08-276-18 - 08-277-18  
18 cm / 7"

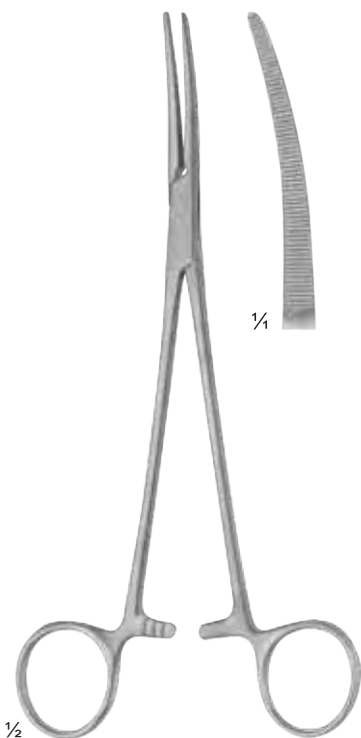

**Dunhill**  
08-279-19  
19 cm / 7½"

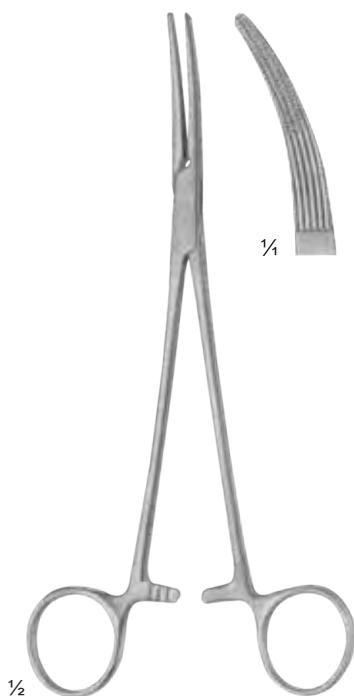

**Grey-Turner**  
08-281-14 = 14.5 cm / 5¾"  
08-281-18 = 18 cm / 7"

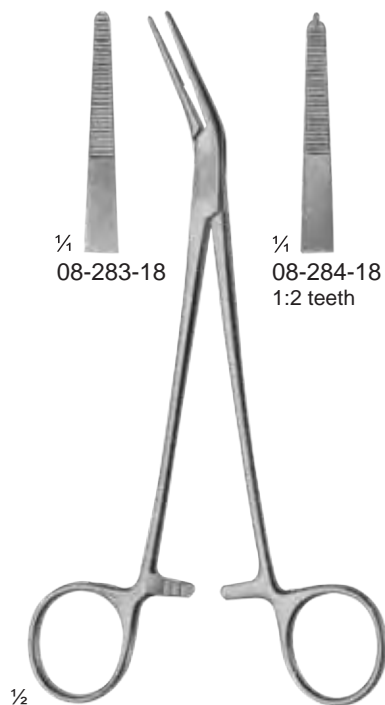

**Fickling**  
08-283-18 - 08-284-18  
18 cm / 7"

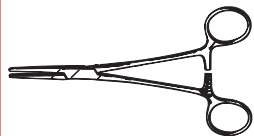

### Artery Forceps, Dissecting and Ligature Forceps

Arterienklemmen, Präparier- und Ligaturklemmen

Pinces hémostatiques, Pinces à disséquer et à ligatures

Pinzas hemostáticas, Pinzas para preparaciones y ligaduras

Pinze emostatiche, Pinze per preparazioni e legature



**Overholt**  
08-291-01 - 08-291-05

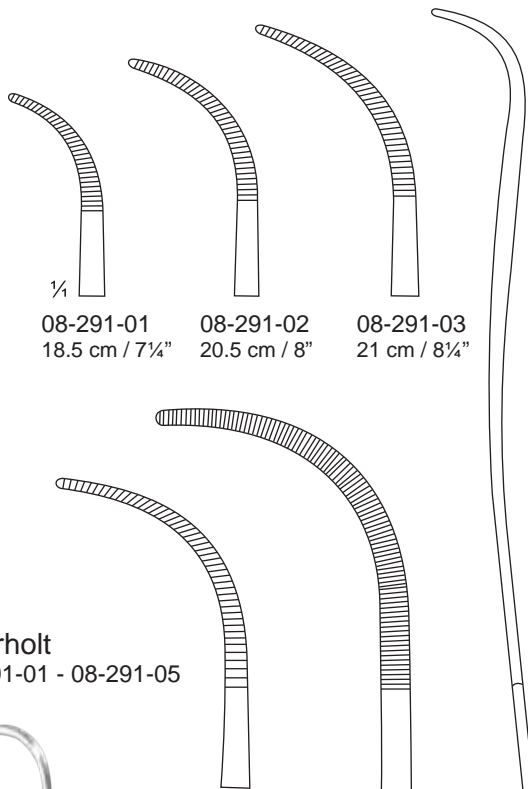

08-291-01  
18.5 cm / 7 1/4"

08-291-02  
20.5 cm / 8"

08-291-03  
21 cm / 8 1/4"

08-291-04  
21.5 cm / 8 1/2"

08-291-05  
24 cm / 9 1/2"



**Baby-Mixer**  
08-293-18  
18 cm / 7"



**Baby-Adson**  
08-295-14 - 08-295-18

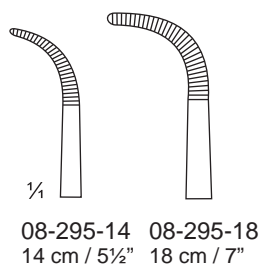

08-295-14  
14 cm / 5 1/2"

08-295-18  
18 cm / 7"

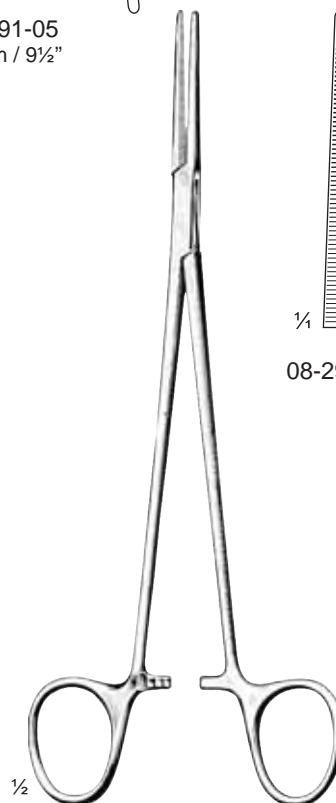

**Heiss**  
08-298-20 - 08-301-20  
20 cm / 8"

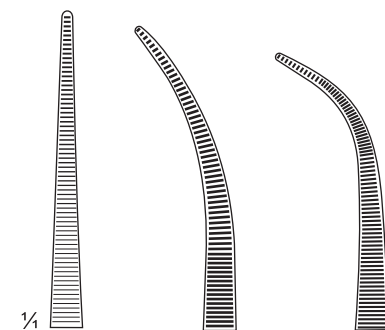

08-298-20

08-299-20

08-301-20

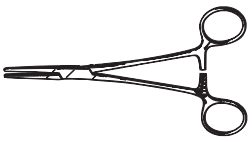

**Artery Forceps, Bronchus Forceps**

Arterienklemmen, Bronchusklemmen  
Pinzas hemostáticas, Pinzas-clamps bronquias

Pinces hémostatiques, Pinces-clamps à bronches  
Pinze emostatiche, Pinze per bronchi

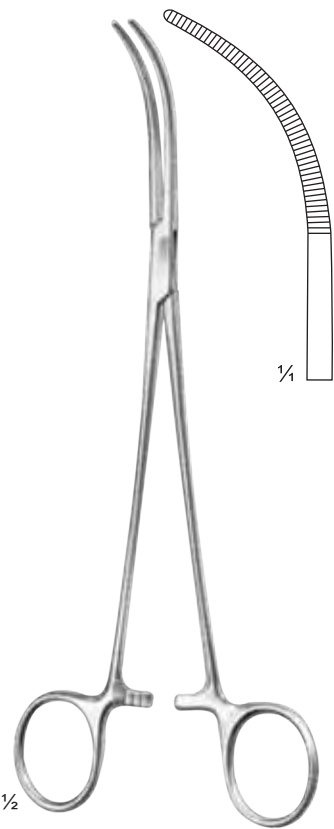

**Overholt-Mixer**  
08-307-21  
21 cm / 8¼"

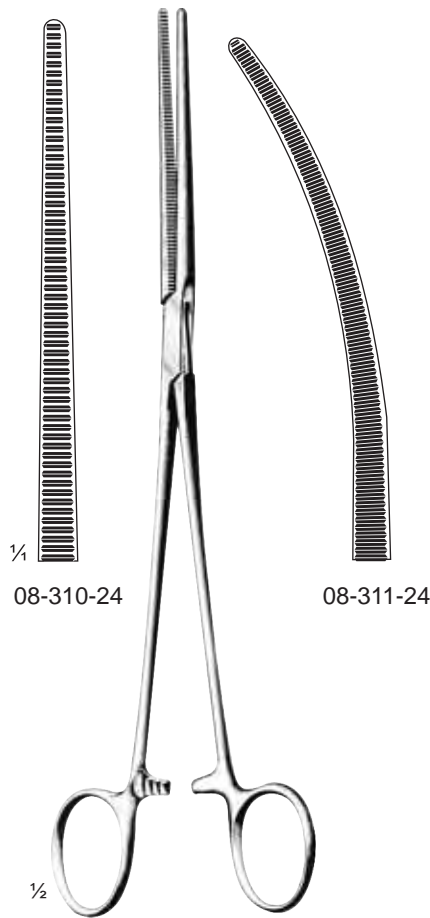

**Sarot**  
08-310-24 - 08-311-24  
24 cm / 9½"

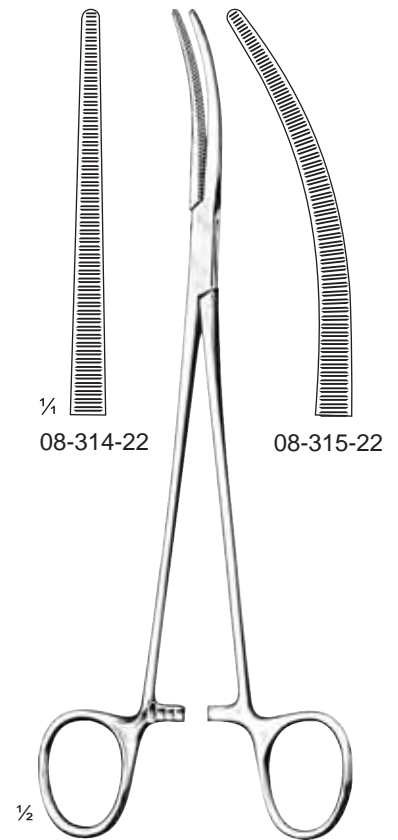

**Roberts**  
08-314-22 - 08-315-22  
22 cm / 8¾"

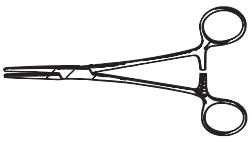

### Auricle Forceps, Dissecting and Ligature Forceps

Aurikelklemmen, Präparier- und Ligaturklemmen  
 Pinzas para aurícula, Pinzas para preparaciones y ligaduras

Pinces auricules, Pinces à disséquer et à ligatures  
 Pinza auricolari, Pinze per preparazioni e legature



1/2

**Crafoord-Sellors**  
 08-321-22 - 08-321-24

1/4

08-321-22  
 22 cm / 8 3/4"

08-321-23  
 23 cm / 9"

08-321-24  
 24 cm / 9 1/2"

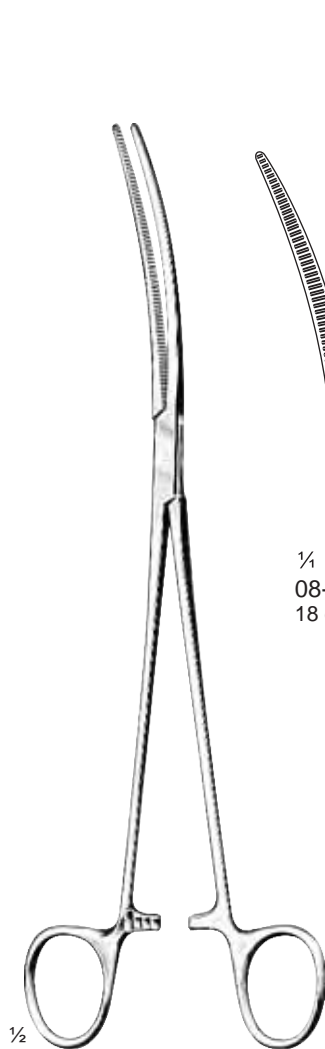

1/2

**Crafoord/Olivercrona**  
 08-323-18 - 08-323-24

1/4

08-323-18  
 18 cm / 7"

08-323-24  
 24 cm / 9 1/2"



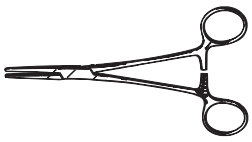

### Auricle Forceps, Dissecting and Ligature Forceps

Aurikelklemmen, Präparier- und Ligaturklemmen  
 Pinzas para aurícula, Pinzas para preparaciones y ligaduras

Pinces auriculaires, Pinces à disséquer et à ligatures  
 Pinza auricolari, Pinze per preparazioni e legature

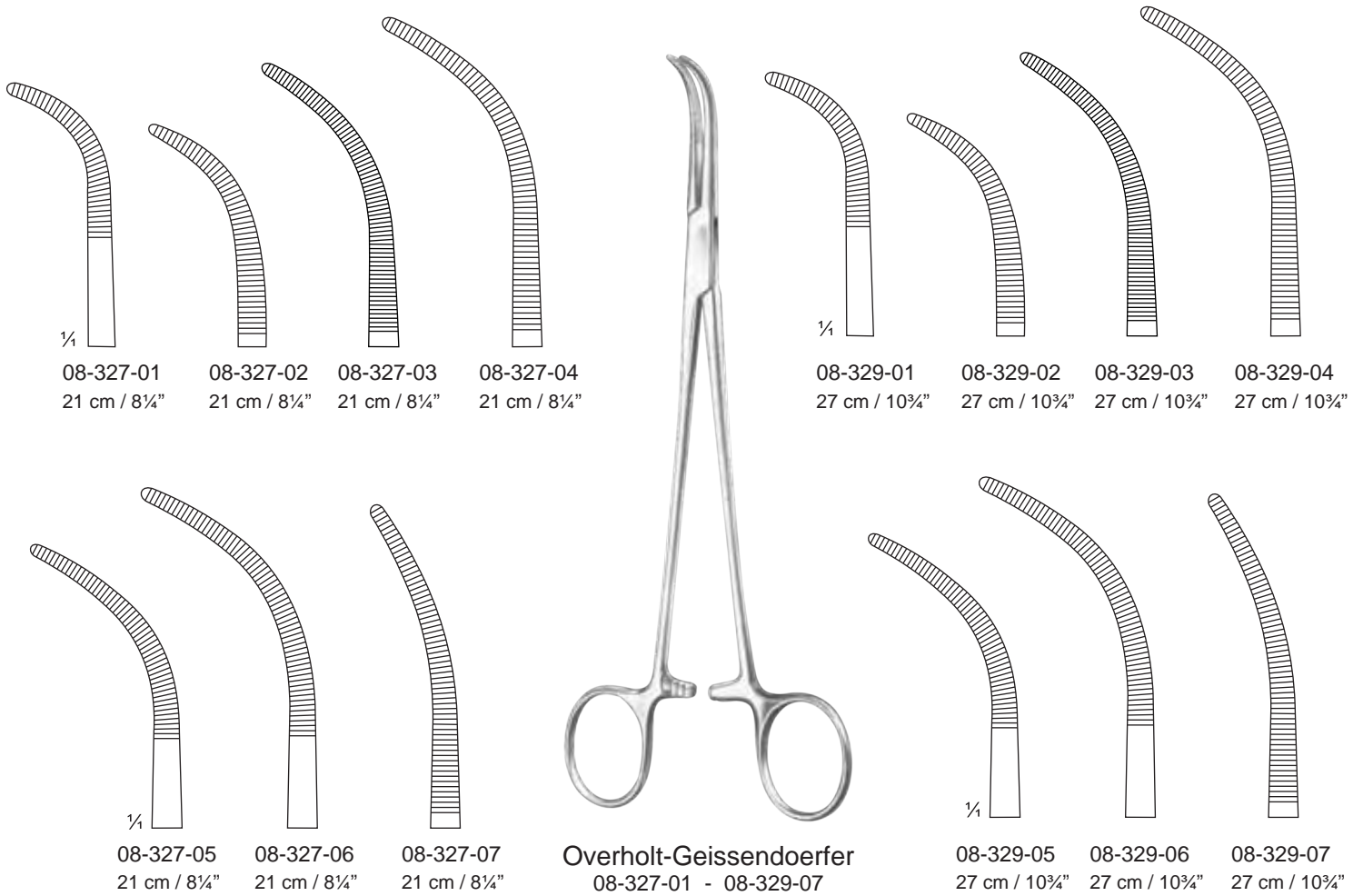

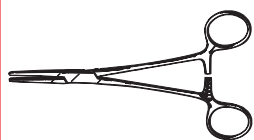

### Dissecting and Ligature Forceps

Präparierklemmen  
Pinzas para preparación y ligadura

Pinces à disséquer et à ligatures  
Pinze per preparazioni e legature

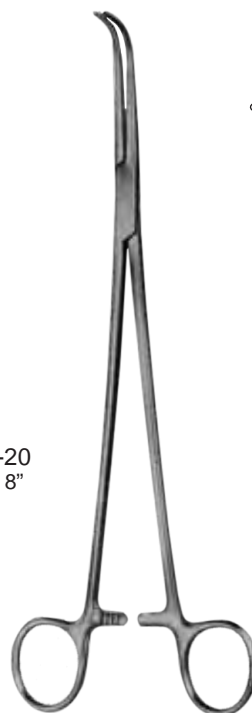
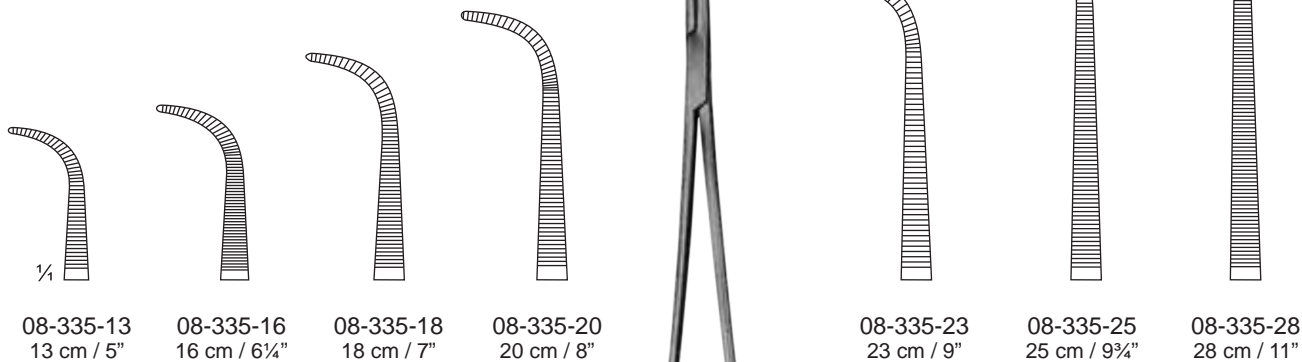

Gemini  
08-335-13 - 08-335-28

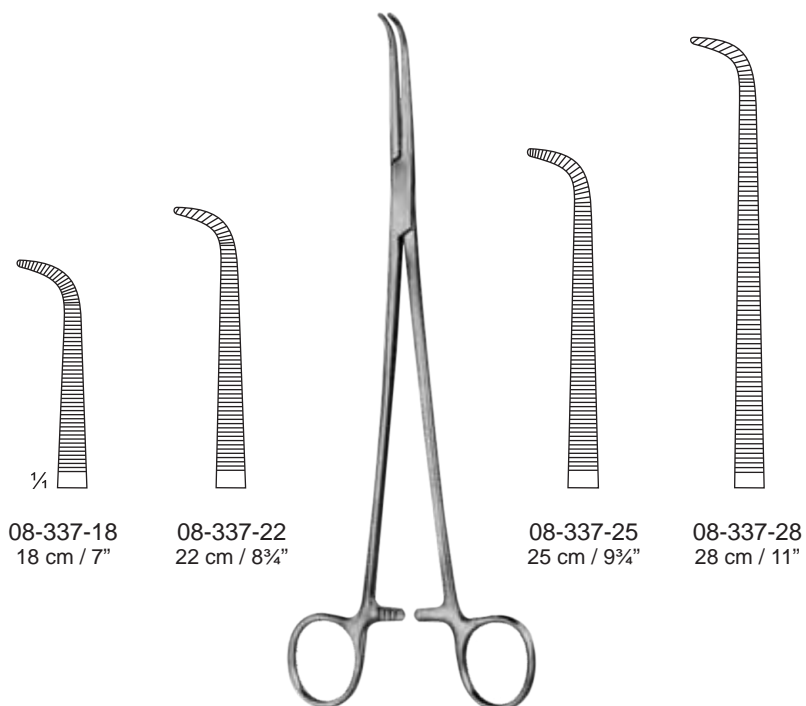

Mini-Gemini  
08-337-18 - 08-337-28

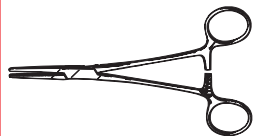

### Dissecting and Ligature Forceps

Präparierklemmen  
Pinzas para preparación y ligadura

Pinces à disséquer et à ligatures  
Pinze per preparazioni e legature

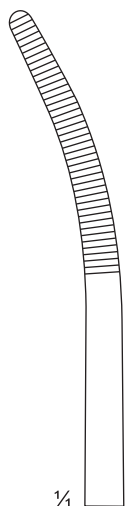

1/4

08-341-01

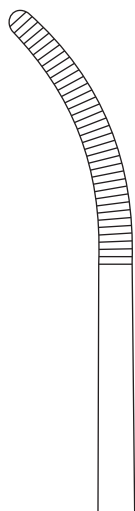

08-341-02

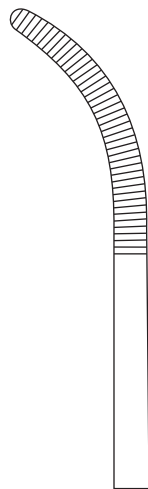

08-341-03



1/8

Rumel

08-341-01 - 08-341-05  
23 cm / 9"

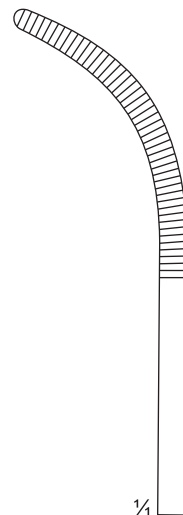

1/4

08-341-04

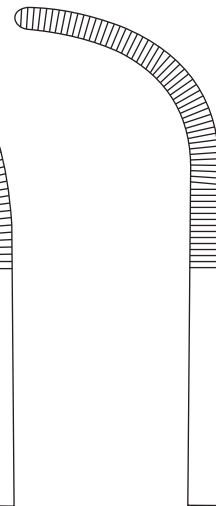

08-341-05



1/4

08-344-21  
21 cm / 8 1/4"

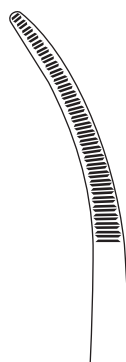

08-345-21  
21 cm / 8 1/4"



1/4

08-346-21  
21 cm / 8 1/4"  
1:2 Teeth

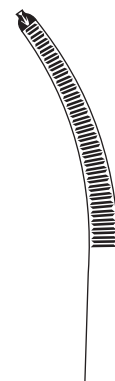

08-347-21  
21 cm / 8 1/4"  
1:2 Teeth



1/4

08-344-26  
26 cm / 10 1/4"

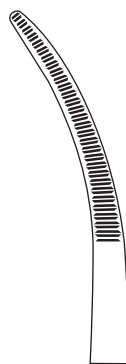

08-345-26  
26cm/10 1/4"



Toennis

08-344-21 - 08-347-26



1/4

08-346-26  
26 cm / 10 1/4"  
1:2 Teeth



08-347-26  
26 cm / 10 1/4"  
1:2 Teeth

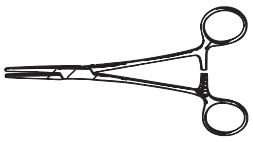

**Dissecting and Ligature Forceps**

Präparierklemmen  
Pinzas para preparación y ligadura

Pinces à disséquer et à ligatures  
Pinze per preparazioni e legature



**Nissen**  
08-351-21  
21.5 cm / 8½"



**Zenker**  
08-353-01 - 08-353-02  
29.5 cm / 11½"

¼  
08-353-01

¼  
08-353-02

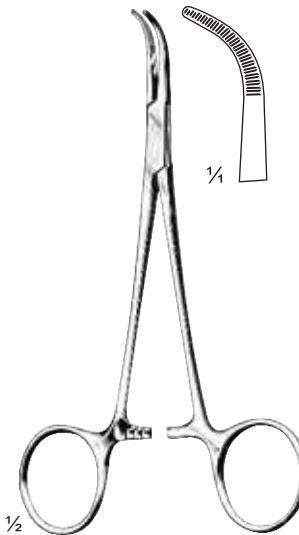

**Mixer-Baby**  
08-355-14  
14 cm / 5½"

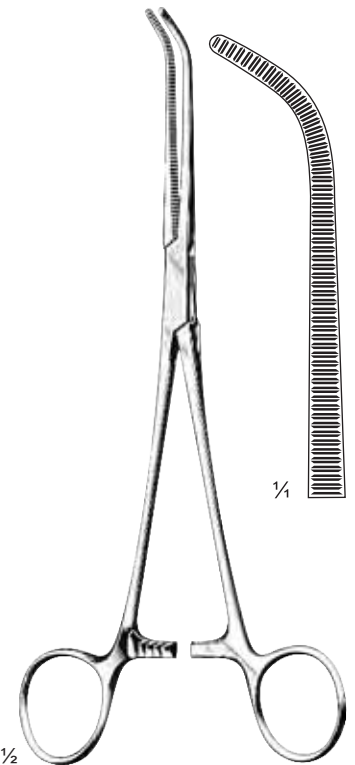

**Johns Hopkins**  
08-357-20  
20 cm / 8"

**Dissecting and Ligature Forceps**

Präparierklemmen  
Pinzas para preparación y ligadura

Pinces à disséquer et à ligatures  
Pinze per preparazioni e legature

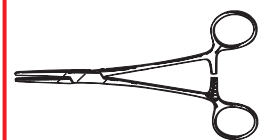

**Finochietto**  
08-362-24  
24.5 cm / 9¾"

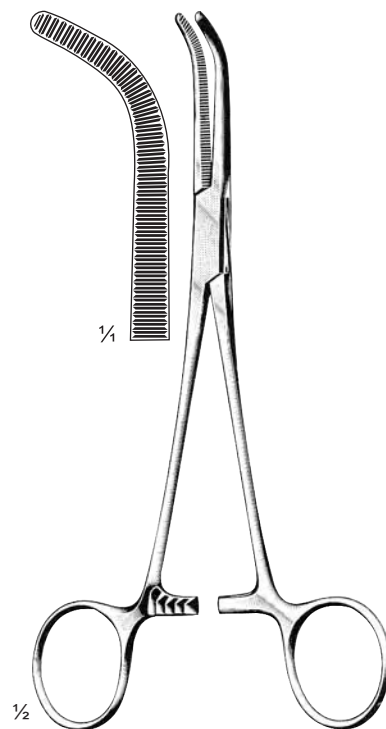

**Mixer-O'Shaugnessy**  
18 cm / 7" 08-365-18  
20 cm / 8" 08-365-20

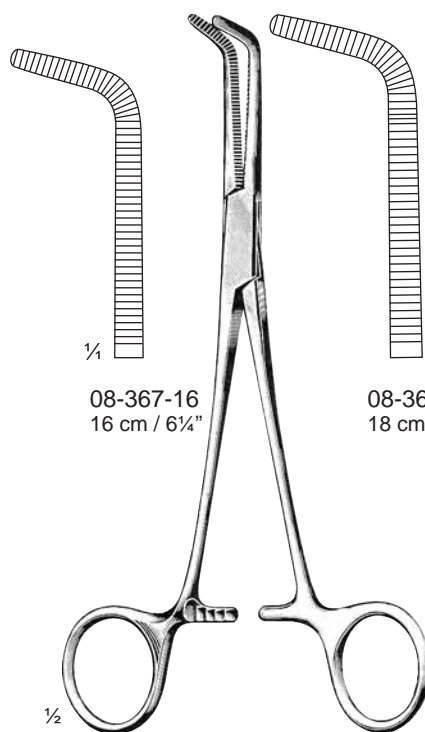

08-367-16  
16 cm / 6¼"

08-367-19  
18 cm / 7"

**Mixer**  
08-367-16 - 08-367-19

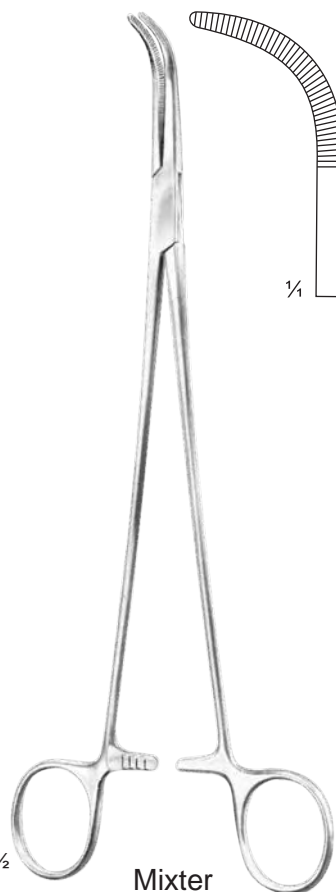

**Mixer**  
08-369-23  
23 cm / 9"

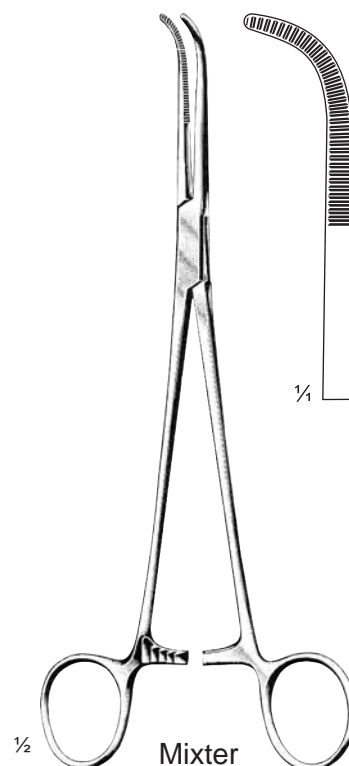

**Mixer**  
08-371-22  
22 cm / 8¾"

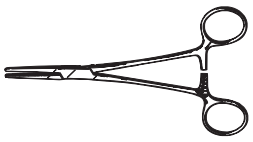

**Dissecting and Ligature Forceps**

Präparierklemmen  
Pinzas para preparación y ligadura

Pinces à disséquer et à ligatures  
Pinze per preparazioni e legature

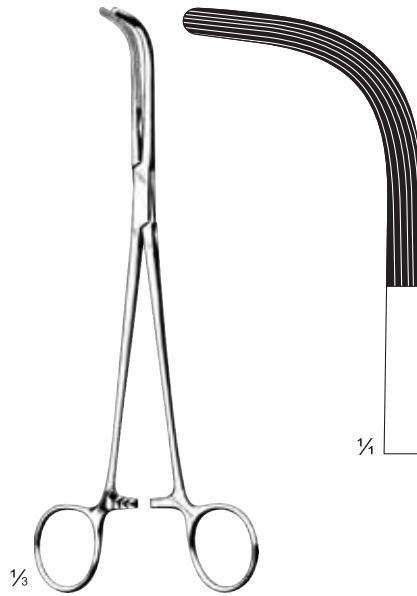

**McQuigg-Mixer**  
08-377-22  
22 cm / 8<sup>3</sup>/<sub>4</sub>"



**Mixer**  
08-379-22 - 08-383-28

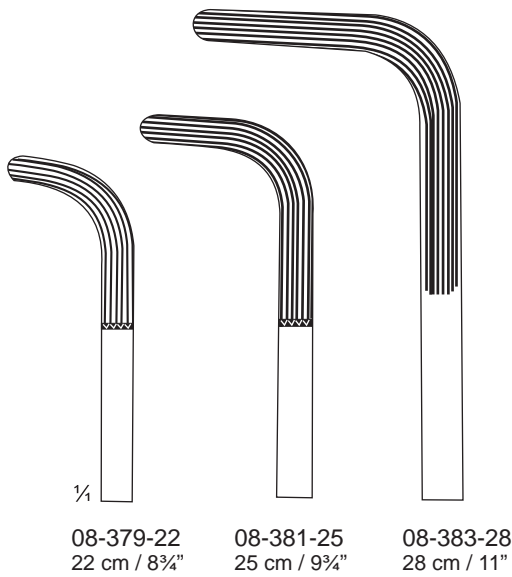

08-379-22  
22 cm / 8<sup>3</sup>/<sub>4</sub>"

08-381-25  
25 cm / 9<sup>3</sup>/<sub>4</sub>"

08-383-28  
28 cm / 11"

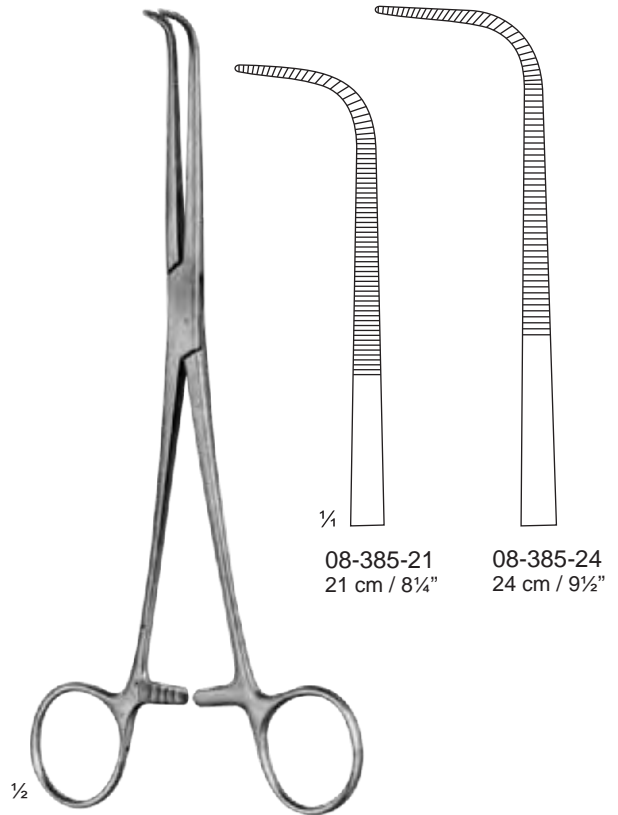

**Wickstrom**  
08-385-21 - 08-385-24

08-385-21  
21 cm / 8<sup>1</sup>/<sub>4</sub>"

08-385-24  
24 cm / 9<sup>1</sup>/<sub>2</sub>"

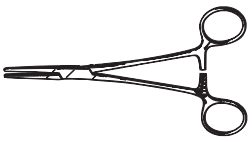

### Gall Duct and Kidney Pedicle Clamp Forceps

Gallenkanal- und Nierenstieltklemmen

Pinces-clamps pour voies biliaires et pédicules rénaux

Pinzas-clamps para conducto biliar y pedúnculos renales

Pinze per vie biliari e peduncoli renali

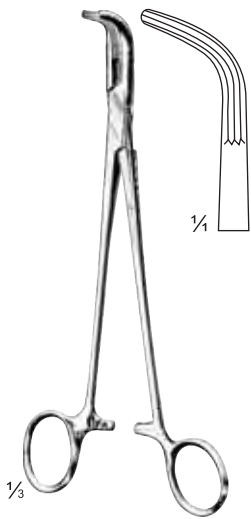

1/3

**Lower**  
08-391-18  
18 cm / 7"

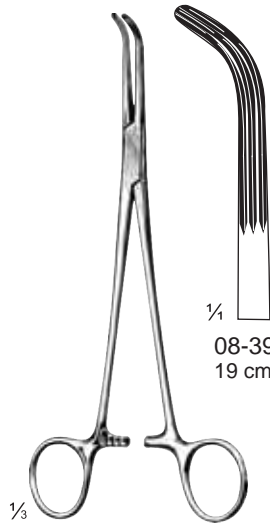

1/3

**Lahey**  
08-393-19 - 08-395-23

1/4

08-393-19  
19 cm / 7 1/2"

1/4

08-395-23  
23 cm / 9"

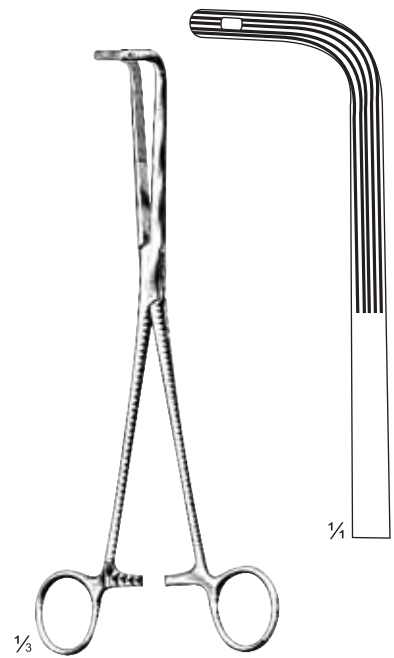

1/3

**Finocchietto**  
08-397-24  
24 cm / 9 1/2"

1/4

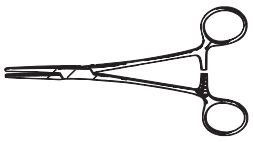

### Tangential Forceps, Kidney Pedicle Clamps

Tangentialklemmen, Nierenstiellklemmen  
 Pinzas tangenciales, Pinzas para pedículo renal

Pinces tangentielles, Pince-clamps pour pédicules rénaux  
 Pinze tangenziali, Pinze per peduncoli renali

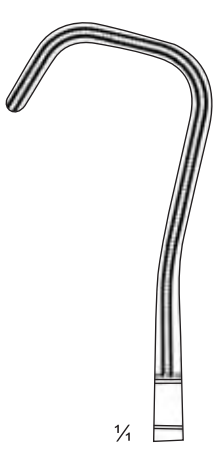

1/4

08-405-01

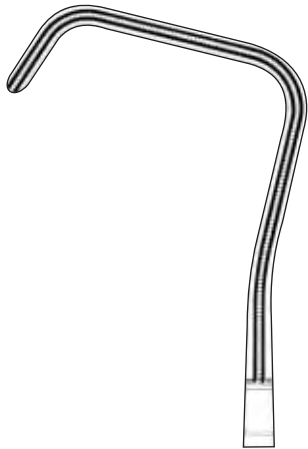

08-405-02

### ATRAUMA

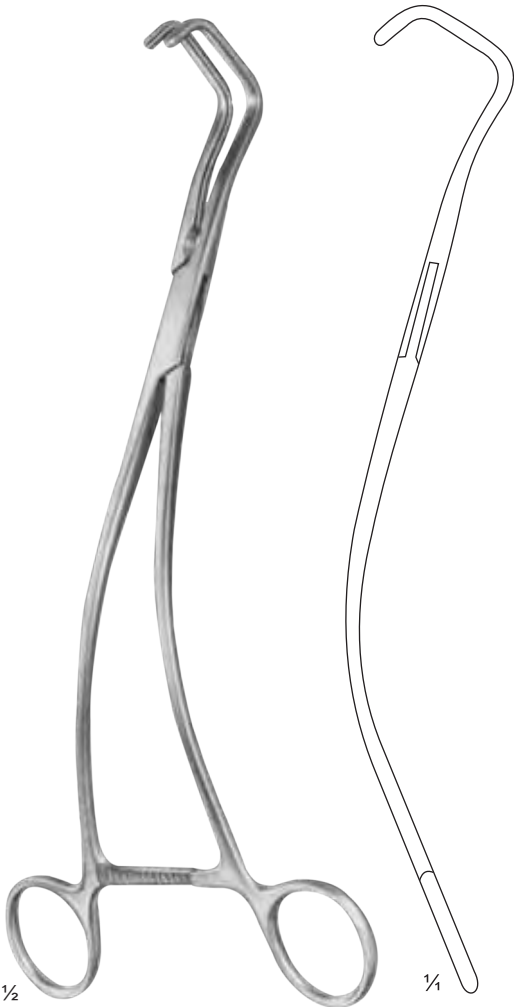

1/2

1/4

**Uro-Tangential**  
 08-405-01 - 08-405-02  
 26 cm / 10 1/4"

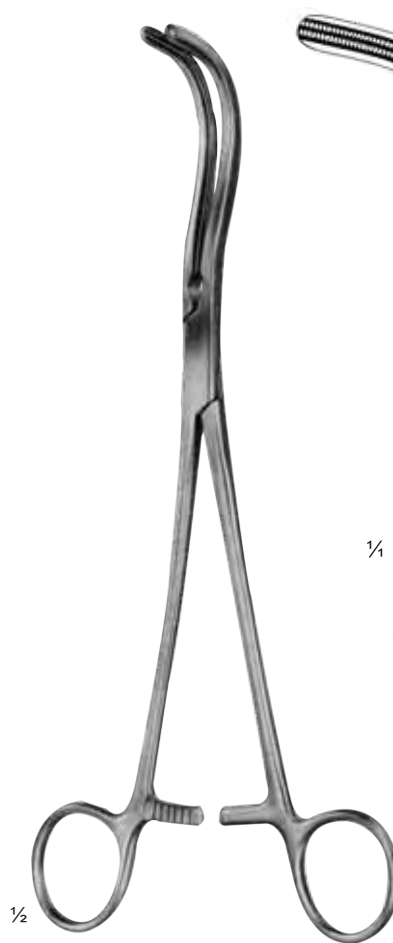

1/2

**Guyon**  
 08-407-23 - 08-407-24

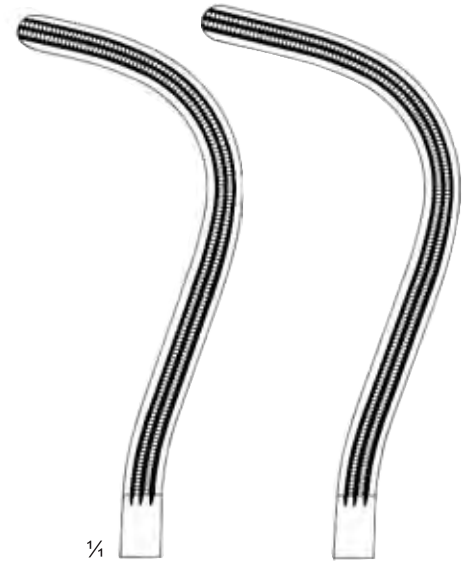

1/4

08-407-23  
 23 cm / 9"

08-407-24  
 24 cm / 9 1/2"



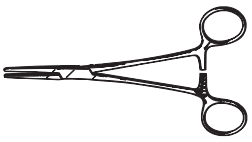

**Kidney Pedicle Clamps**

Nierenstielklemmen  
Pinzas para pedículo renal

Pince-clamps pour pédicules rénaux  
Pinze per peduncoli renali

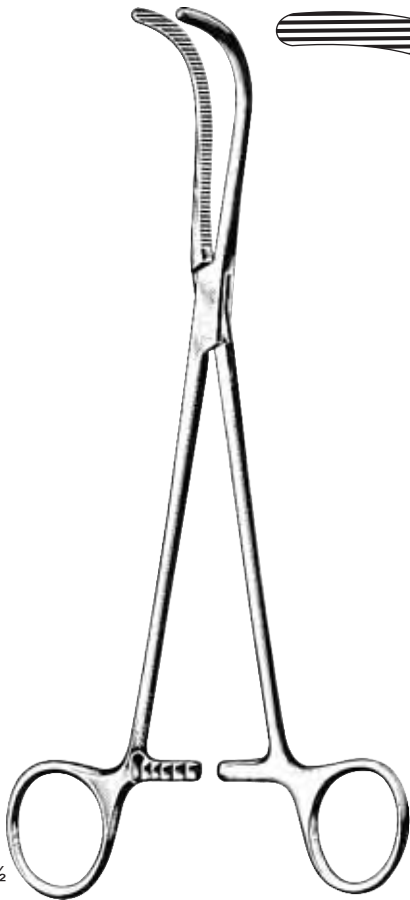

Guyon  
08-413-23  
23 cm / 9"

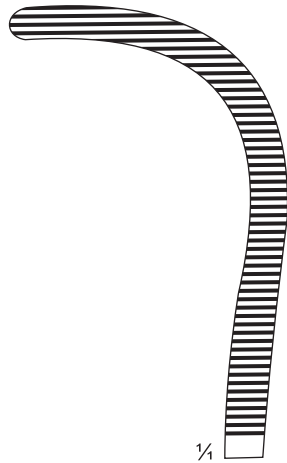

1/4

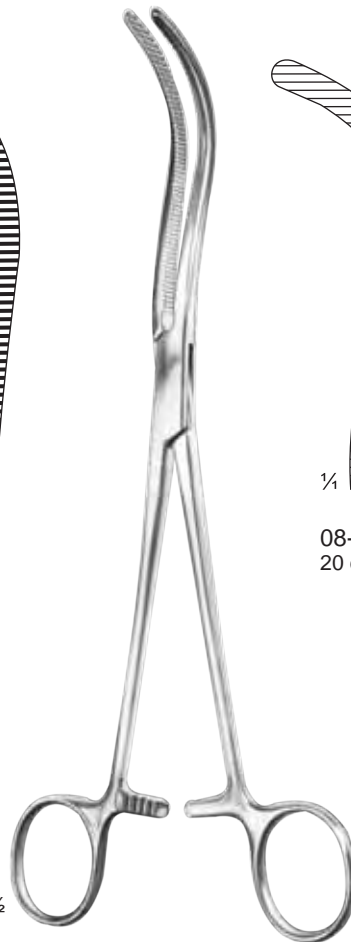

Guyon  
08-415-20 - 08-415-24

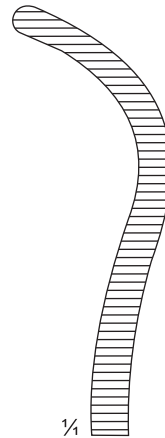

1/4

08-415-20  
20 cm / 8"

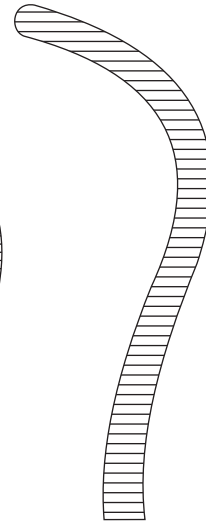

08-415-22  
22 cm / 8 3/4"

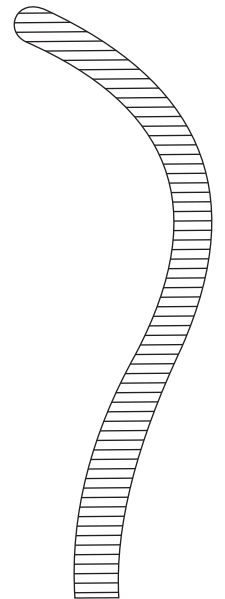

08-415-24  
24 cm / 9 1/2"

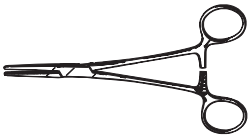

**Kidney Pedicle Clamps**

Nierenstielklemmen  
Pinzas para pedículo renal

Pince-clamps pour pédicules rénaux  
Pinze per peduncoli renali

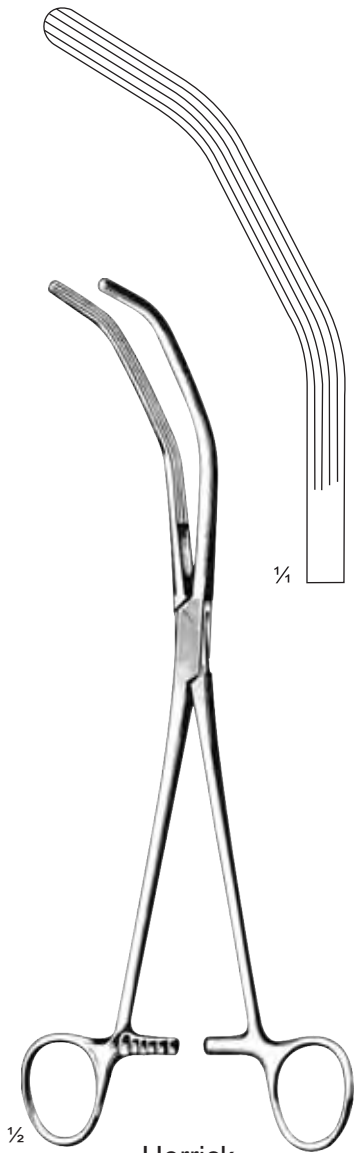

**Herrick**  
08-421-23  
23 cm / 9"

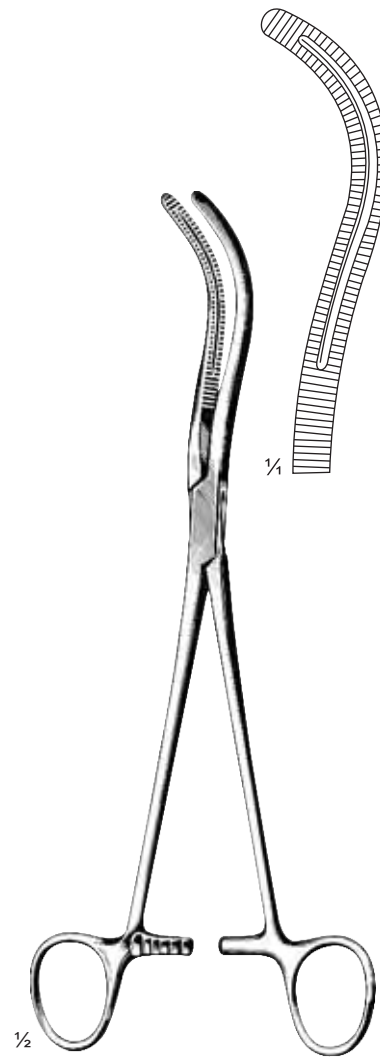

**Stille**  
08-423-23  
23 cm / 9"

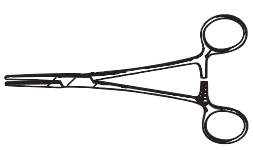

**Bile Duct Clamps**

Gallenkanalklemmen  
Pinzas para conducto biliar

Pinces pour les voies biliaires  
Pinze per vie biliari

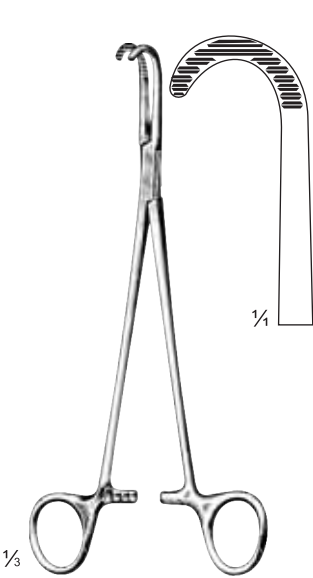

**Desjardins**  
08-429-21  
21 cm / 8¼"

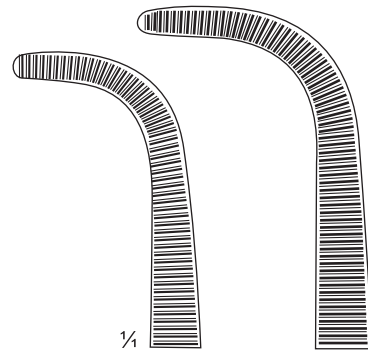

08-431-22  
22 cm / 8¾"

08-433-23  
23 cm / 9"

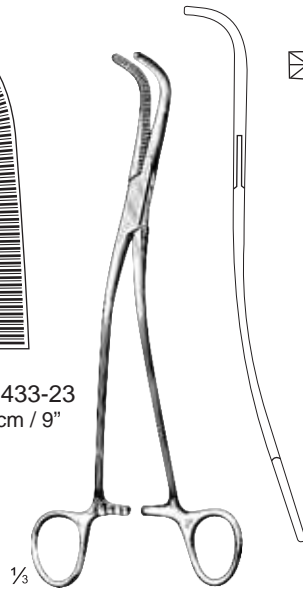

**Gray**  
08-431-22 - 08-437-23

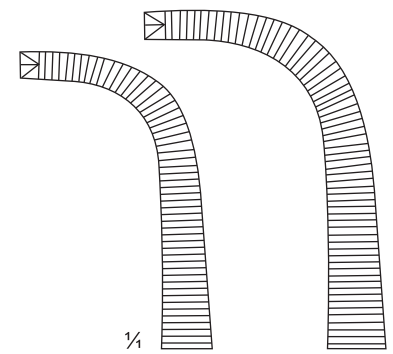

1:2  
08-435-22  
22 cm / 8¾"

1:2  
08-437-23  
23 cm / 9"

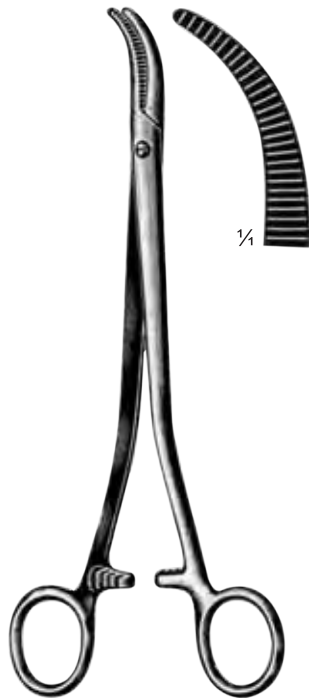

**Moynihan**  
08-439-23  
23 cm / 9"

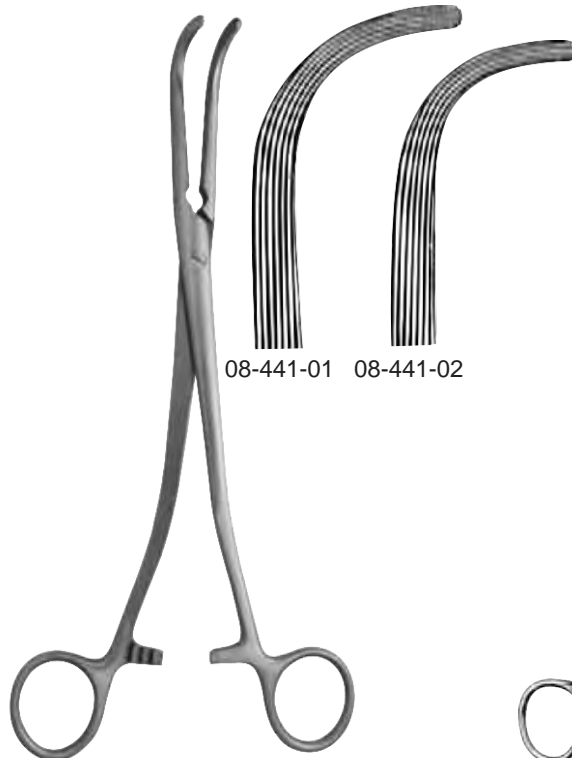

08-441-01

08-441-02

**Geary-Grant**  
08-441-01  
08-441-02  
23 cm / 9"

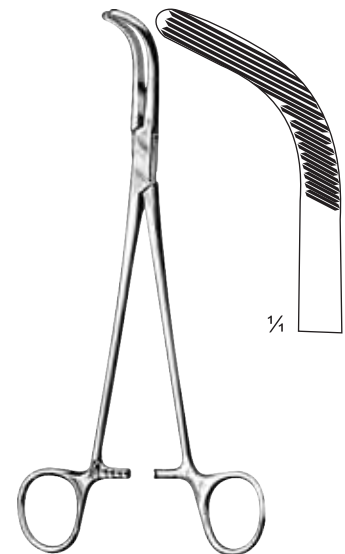

**Crile/Mile-Phillips**  
08-443-20  
20 cm / 8"

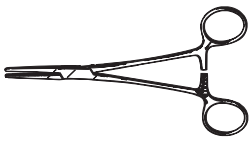

### Artery Forceps, Dissecting and Ligature Forceps

Arterienklemmen, Präparier- und Ligaturklemmen  
 Pinzas hemostáticas, Pinzas para preparaciones y ligaduras

Pinces hémostatiques, Pinces à disséquer et à ligatures  
 Pinze emostatiche, Pinze per preparazioni e legature

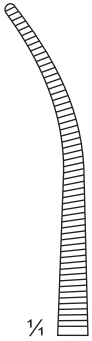

1/4  
 08-449-19  
 19 cm / 7 1/2"

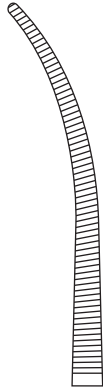

08-449-22  
 22 cm / 8 3/4"



08-449-24  
 24 cm / 9 1/2"

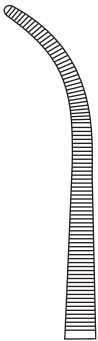

08-451-19  
 19 cm / 7 1/2"

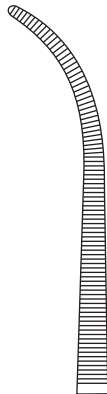

08-451-22  
 22 cm / 8 3/4"



08-451-24  
 24 cm / 9 1/2"



Kelly  
 08-449-19 - 08-453-24

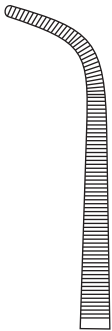

08-453-19  
 19 cm / 7 1/2"

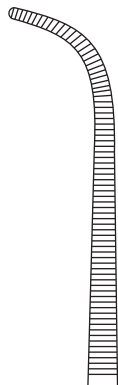

08-453-22  
 22 cm / 8 3/4"

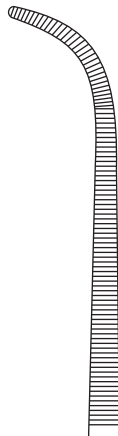

08-453-24  
 24 cm / 9 1/2"

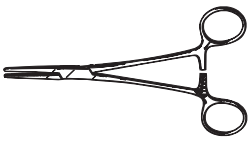

**Dissecting and Ligature Forceps**

Präparierklemmen  
Pinzas para preparación y ligadura

Pinces à disséquer et à ligatures  
Pinze per preparazioni e legature



**Kantrowitz**  
08-459-20 - 08-459-28



08-459-20  
20 cm / 8"



08-459-24  
24 cm / 9½"



08-459-28  
28 cm / 11"

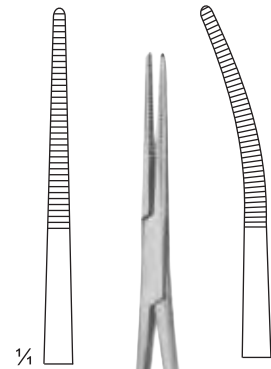

08-462-19



08-463-19



**Birkett**  
08-462-19 - 08-463-19  
19 cm / 7½"

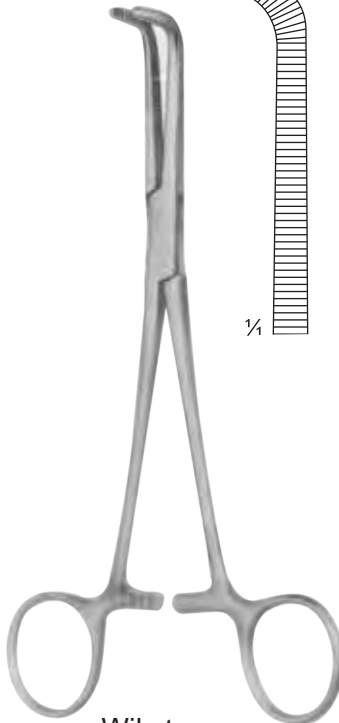

**Wikstroem**  
08-465-19  
19 cm / 7½"



08-468-28

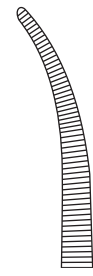

08-469-28

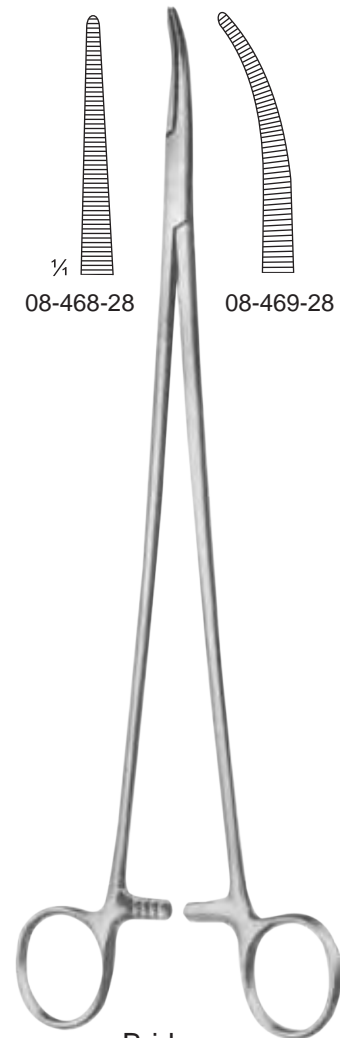

**Bridge**  
08-468-28 - 08-469-28  
28 cm / 11"

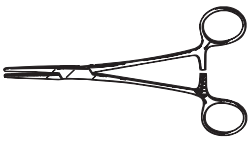

### Artery Forceps, Dissecting and Ligature Forceps

Arterienklemmen, Präparier- und Ligaturklemmen  
 Pinzas hemostáticas, Pinzas para preparaciones y ligaduras

Pinces hémostatiques, Pinces à disséquer et à ligatures  
 Pinze emostatiche, Pinze per preparazioni e legature

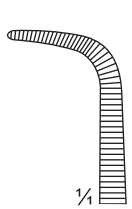

08-474-18  
 18 cm / 7"



**Meeker**  
 08-474-18 - 08-474-28

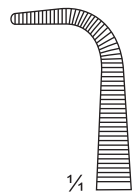

08-474-28  
 27.5 cm / 10¾"



**Lawrence**  
 08-477-28  
 27.5 cm / 10¾"

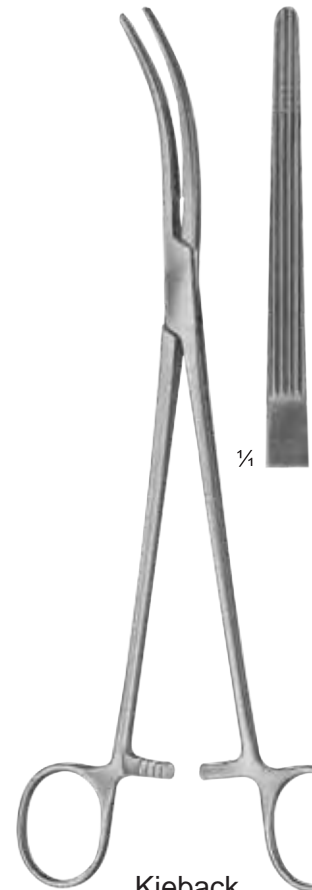

**Kieback**  
 08-479-23  
 23.5 cm / 9¼"

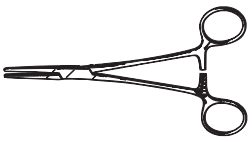

**Bile Duct Clamps**

Gallenkanalklemmen  
Pinzas para conducto biliar

Pinces pour les voies biliaires  
Pinze per vie biliari

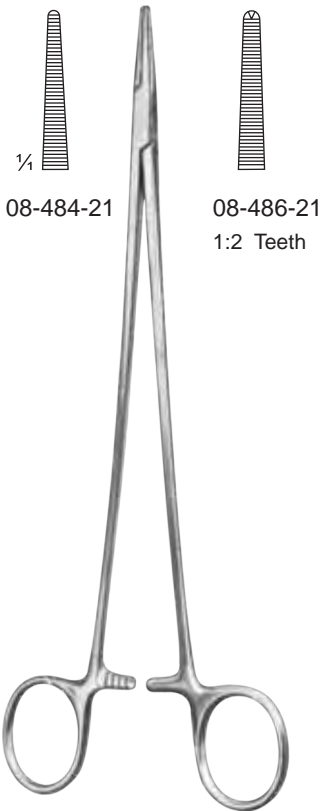

08-484-21

08-486-21  
1:2 Teeth

**Hosemann**  
08-484-21 - 08-486-21  
21 cm / 8 1/4"

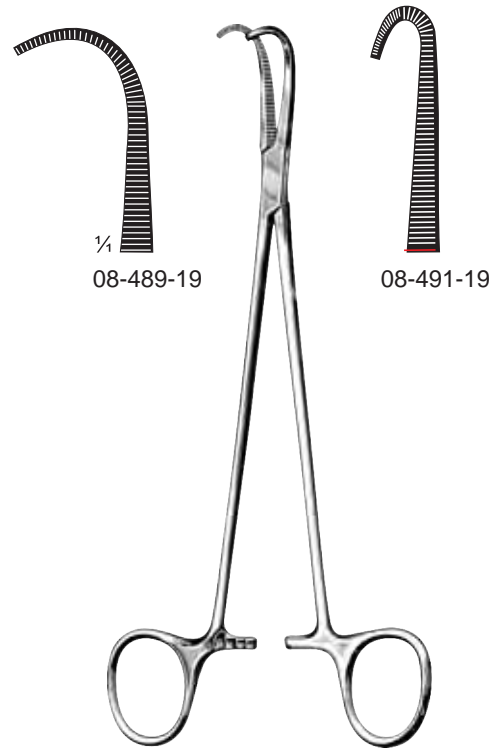

08-489-19

08-491-19

**Negus**  
08-489-19 - 08-491-19  
19 cm / 7 1/2"

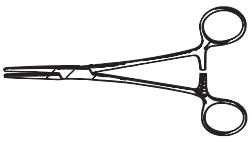

### Tonsil Hemostatic Forceps, Artery Forceps

Tonsillenklemmen, Arterienklemmen  
 Pinzas hemostáticas para amígdalas, Pinzas hemostáticas

Pinces hémostatiques pour amygdales, Pinces hémostatiques  
 Pinze emostatiche per tonsille, Pinze emostatiche

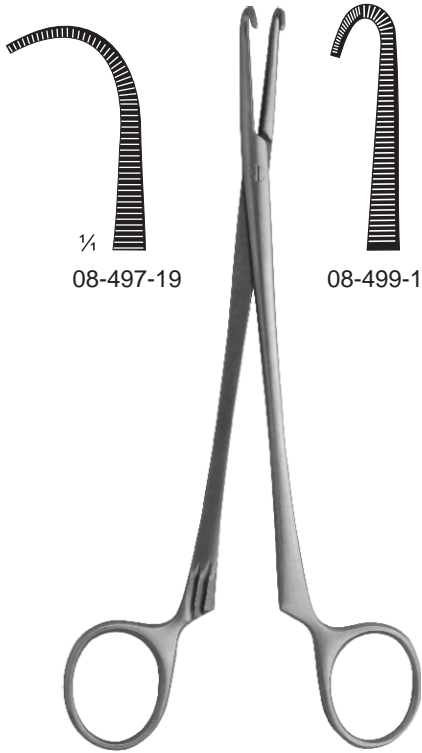

1/4  
 08-497-19

08-499-19

**Negus**  
 08-497-19 - 08-499-19  
 19 cm / 7½"

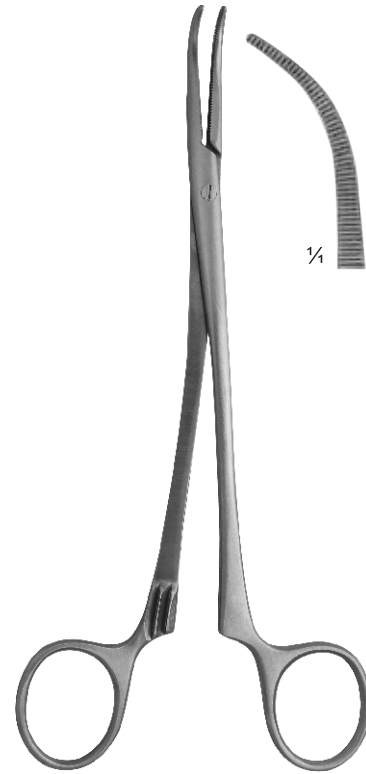

1/4

**Wilson**  
 08-501-19  
 19 cm / 7½"



**Denis Browne**  
 08-503-21  
 21 cm / 8¼"



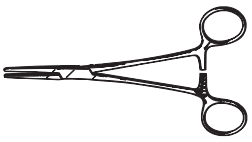

### Hysterectomy Forceps

Hysterektomieklemmen  
Pinzas para histerectomía

Pinces à hystérectomie  
Pinze per isterectomia

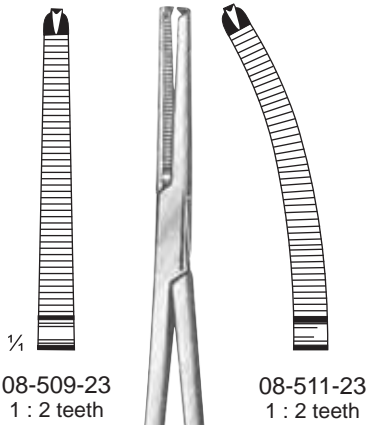

08-509-23  
1 : 2 teeth

08-511-23  
1 : 2 teeth

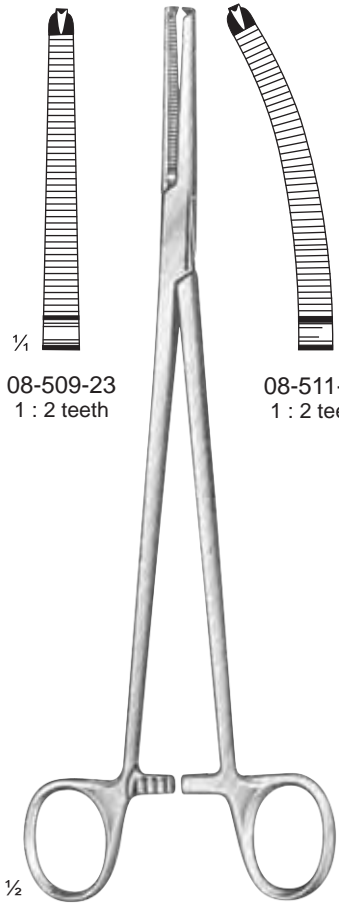

Holzbach  
23.5 cm / 9 1/4"



Heaney  
08-513-19 - 08-517-23

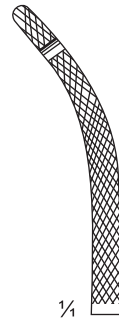

1/4  
08-513-19  
19.5 cm / 7 3/4"



08-513-21  
21 cm / 8 1/4"

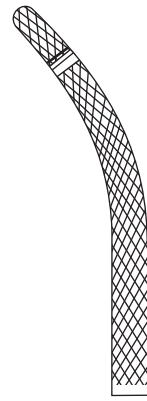

08-513-23  
23 cm / 9"



1/4  
08-517-19  
19.5 cm / 7 3/4"



08-517-21  
21 cm / 8 1/4"

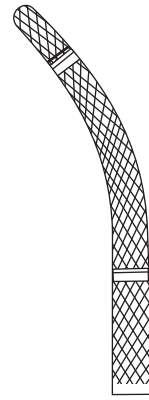

08-517-23  
23 cm / 9"

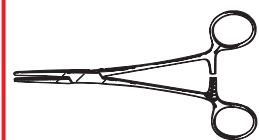

### Hysterectomy Forceps

Hysterektomieklemmen  
Pinzas para histerectomía

Pinces à hystérectomie  
Pinze per isterectomia

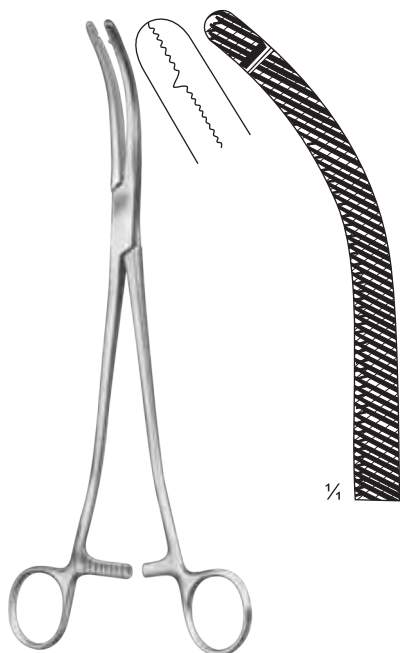

**Wiener**  
08-523-20 = 20 cm / 8"  
08-523-22 = 22 cm / 8 3/4"  
08-523-25 = 25 cm / 9 3/4"

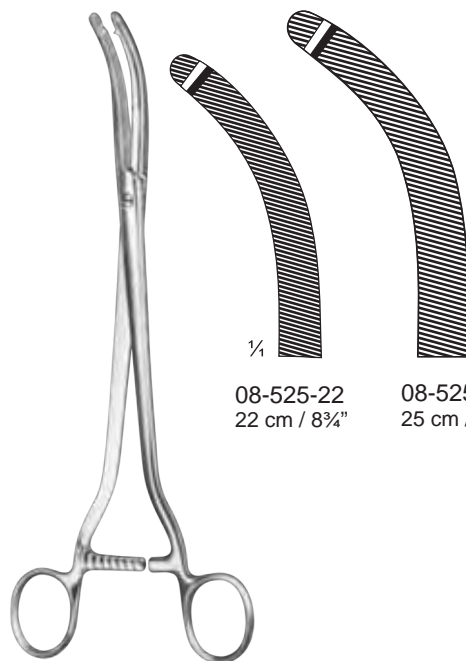

08-525-22 22 cm / 8 3/4"  
08-525-25 25 cm / 9 3/4"

**Wiener**  
08-525-22 - 08-525-25

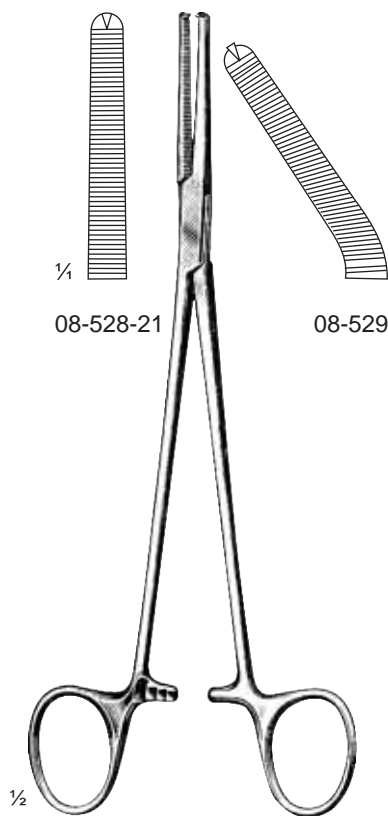

**Phaneuf**  
08-528-21 - 08-529-21  
21.5 cm / 8 1/2"  
1 : 2 teeth

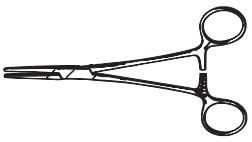

### Hysterectomy Forceps

Hysterektomieklemmen  
Pinzas para histerectomía

Pinces à hystérectomie  
Pinze per isterectomia

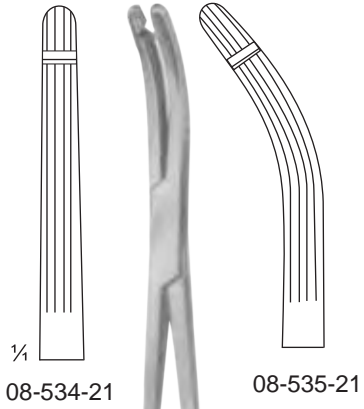

**Heaney-Ballantine**  
21 cm / 8 1/4"

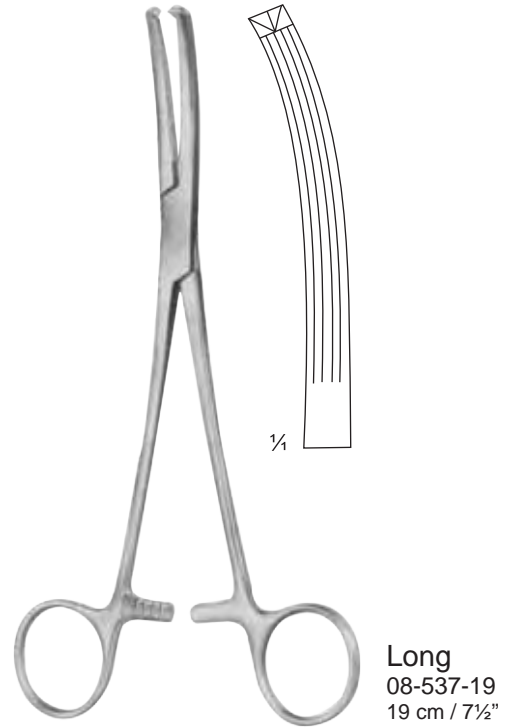

**Long**  
19 cm / 7 1/2"

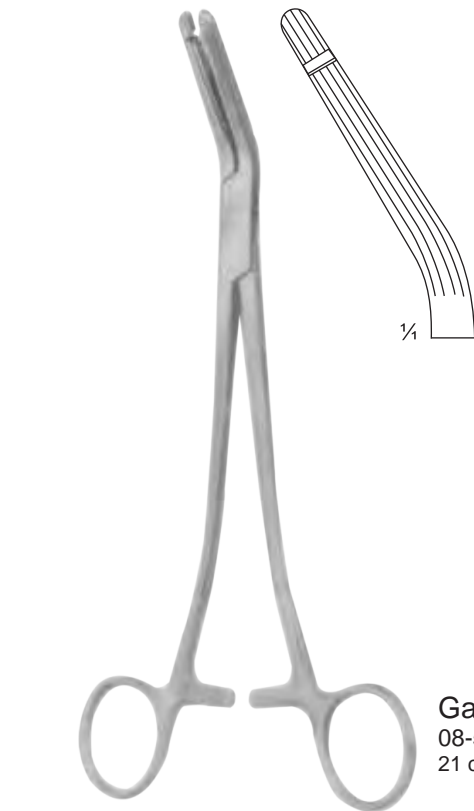

**Garland**  
08-539-21  
21 cm / 8 1/4"

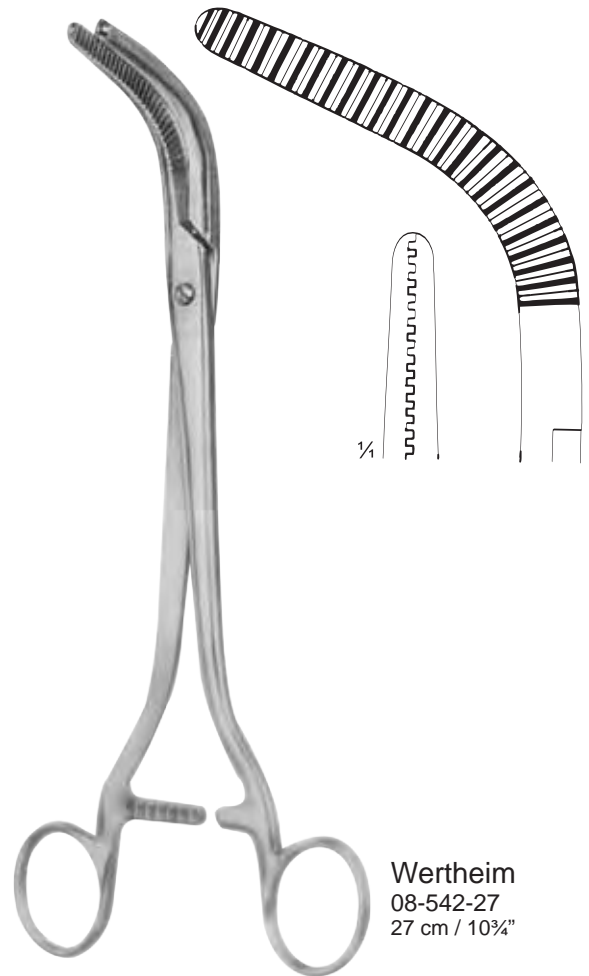

**Wertheim**  
08-542-27  
27 cm / 10 3/4"

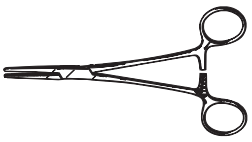

### Hysterectomy Forceps

Hysterektomieklemmen  
Pinzas para histerectomía

Pinces à hystérectomie  
Pinze per isterectomia

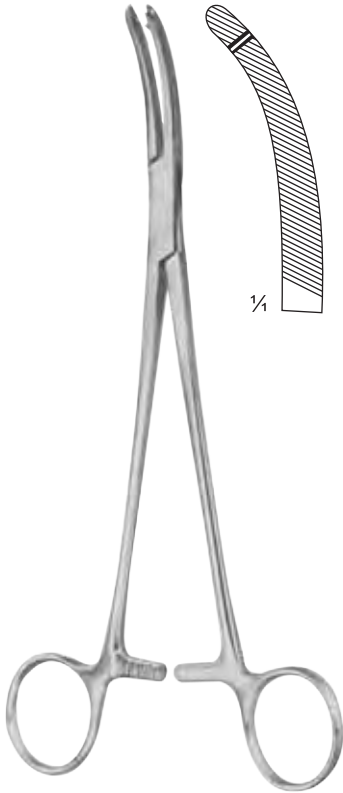

**Heaney**  
08-549-21  
21 cm / 8¼"

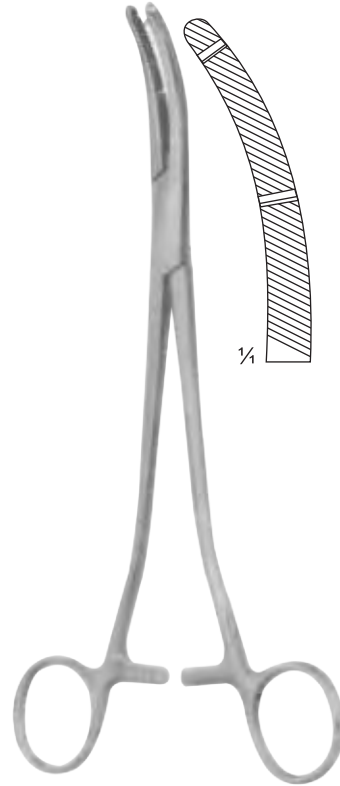

**Heaney-Kanter**  
08-551-21  
21 cm / 8¼"

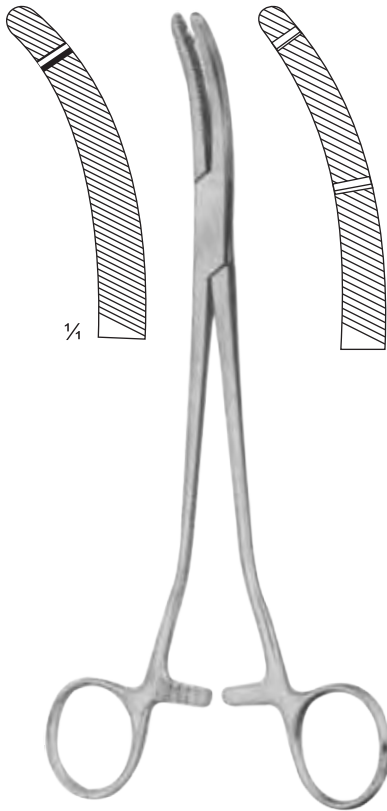

**Heaney**  
08-553-21 21 cm / 8¼" 08-555-21  
08-553-23 23 cm / 9" 08-555-23

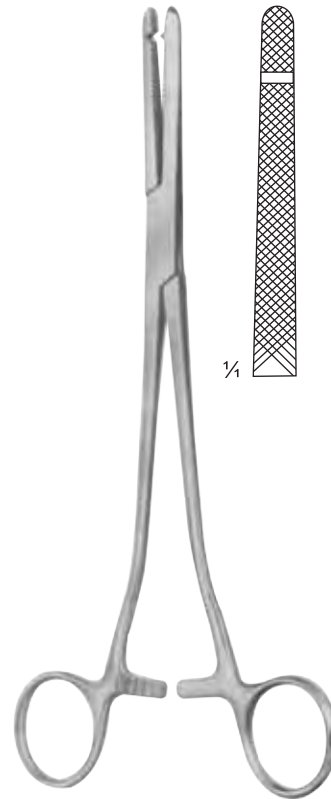

**Heaney-Rezak**  
08-557-21  
21 cm / 8¼"

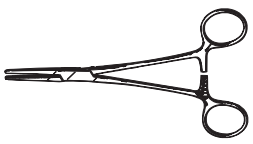

### Hysterectomy Forceps

Hysterektomieklemmen  
Pinzas para histerectomía

Pinces à hystérectomie  
Pinze per isterectomia

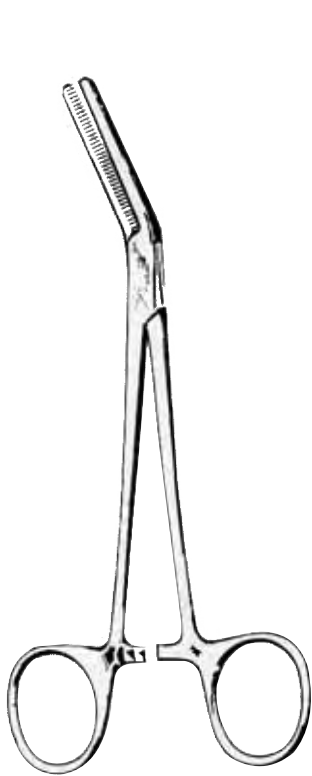

Liverpool Hosp.  
08-563-20  
20 cm / 8"



1 x 2 teeth

Barkeley-Bonney  
08-565-20  
20 cm / 8"



1 x 2 teeth

Bonney  
08-569-20  
20 cm / 8"



Navratill  
08-571-23  
23 cm / 9"

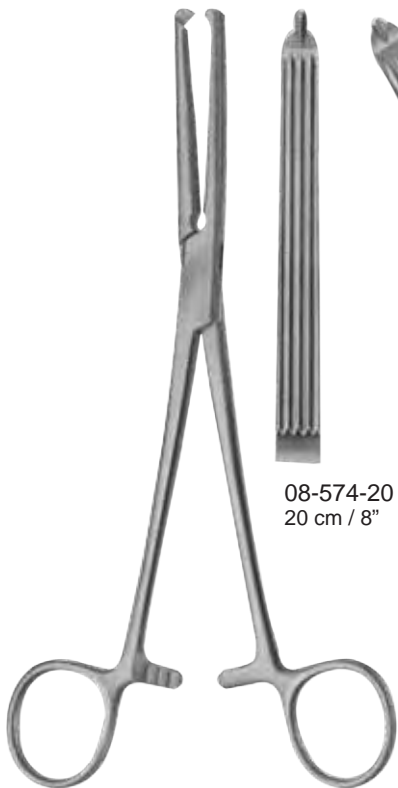

Gwilliam  
08-574-20 – 08-575-20



08-574-20 20 cm / 8"  
08-575-20 20 cm / 8"



Berkeley-Bonney  
08-577-20  
20 cm / 8"

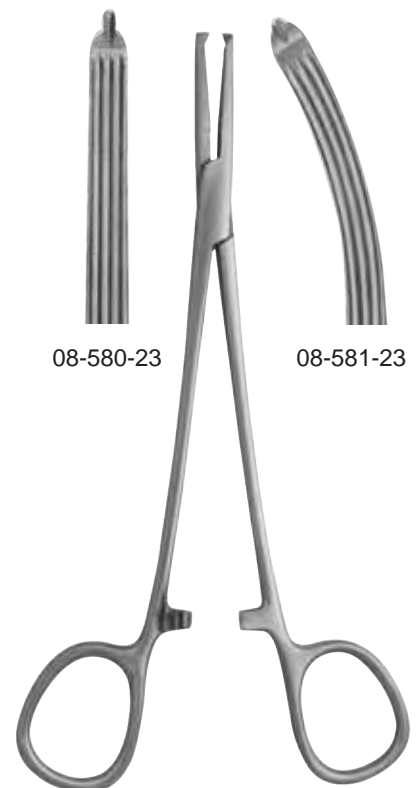

Mc Cullagh  
08-580-23 - 08-581-23  
23 cm / 9"

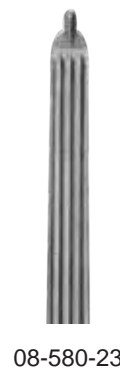

08-580-23



08-581-23

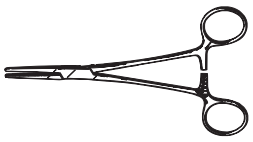

**Hysterectomy Forceps**

Hysterektomieklemmen  
Pinzas para histerectomía

Pinces à hystérectomie  
Pinze per isterectomia



08-587-25  
25 cm / 9¾"

08-588-25  
26 cm / 10¼"

**Burke**  
08-587-25 - 08-588-26



08-590-20  
20.5 cm / 8"

08-593-20 08-595-25  
20.5 cm / 8" 25 cm / 9¾"

**Maingot**  
08-590-20 - 08-595-25

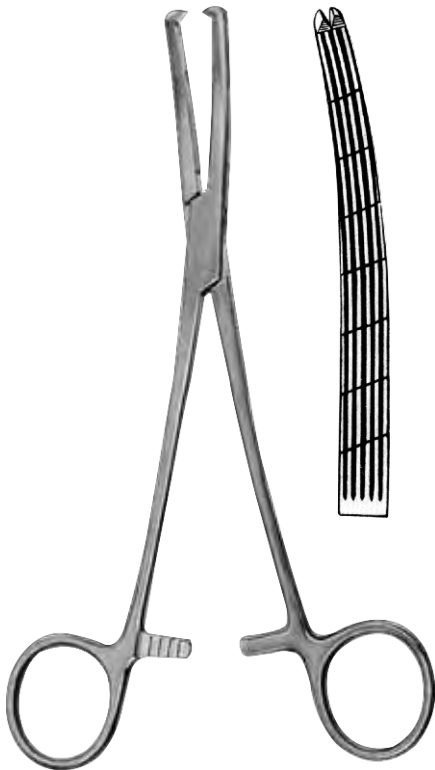

**Hunter**  
08-597-23  
23 cm / 9"



**Chelsea Hosp.**  
08-600-20  
20 cm / 8"

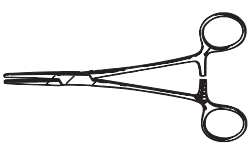

### Hysterectomy Forceps

Hysterektomieklemmen  
Pinzas para histerectomía

Pinces à hystérectomie  
Pinze per isterectomia

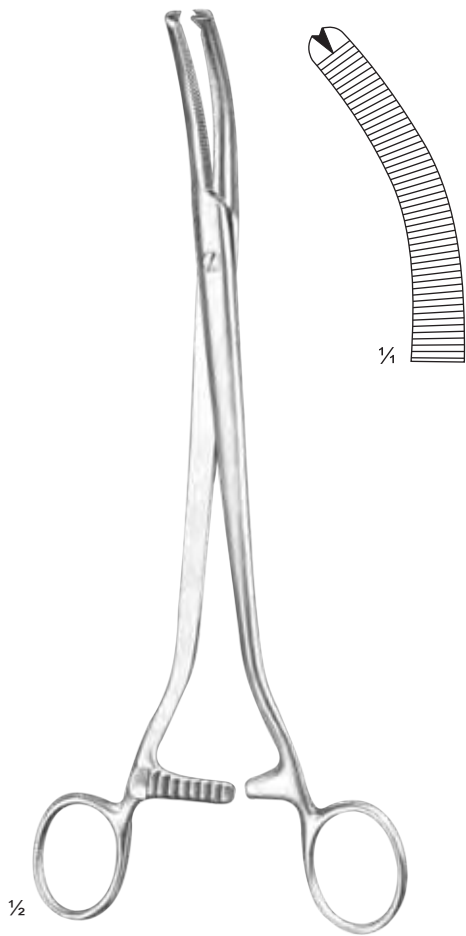

Wertheim  
08-607-24  
24 cm / 9½"



Wertheim-Cullen  
08-609-21  
21.5 cm / 8½"

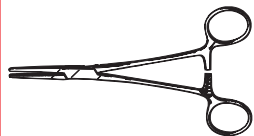

**Parametrium Forceps**

Parametriumklemmen  
Pinzas-clamps para parametrium

Pinces-clamps pour parametrium  
Pinze per parametrium

**ATRAUMA**

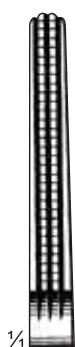

08-613-10  
22 cm / 8<sup>3</sup>/<sub>4</sub>"



08-613-20  
21.5 cm / 8<sup>1</sup>/<sub>2</sub>"

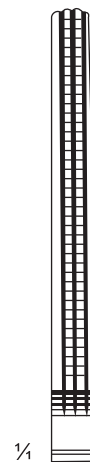

08-615-10  
25 cm / 9<sup>3</sup>/<sub>4</sub>"

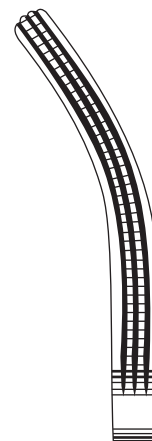

08-615-20  
25 cm / 9<sup>3</sup>/<sub>4</sub>"

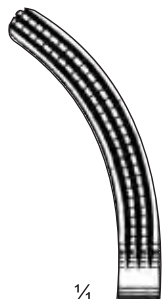

08-613-30  
21.5 cm / 8<sup>1</sup>/<sub>2</sub>"

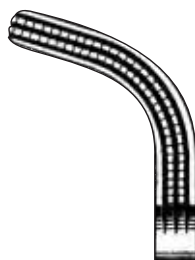

08-613-40  
20.5 cm / 8"

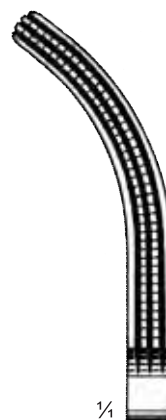

08-615-30  
24.5 cm / 9<sup>3</sup>/<sub>4</sub>"

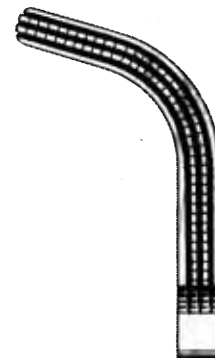

08-615-40  
23 cm / 9"



Rogers  
08-613-10 - 08-615-40



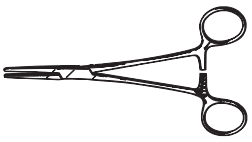

### Hysterectomy Forceps

Hysterektomieklemmen  
Pinzas para histerectomía

Pinces à hystérectomie  
Pinze per isterectomia

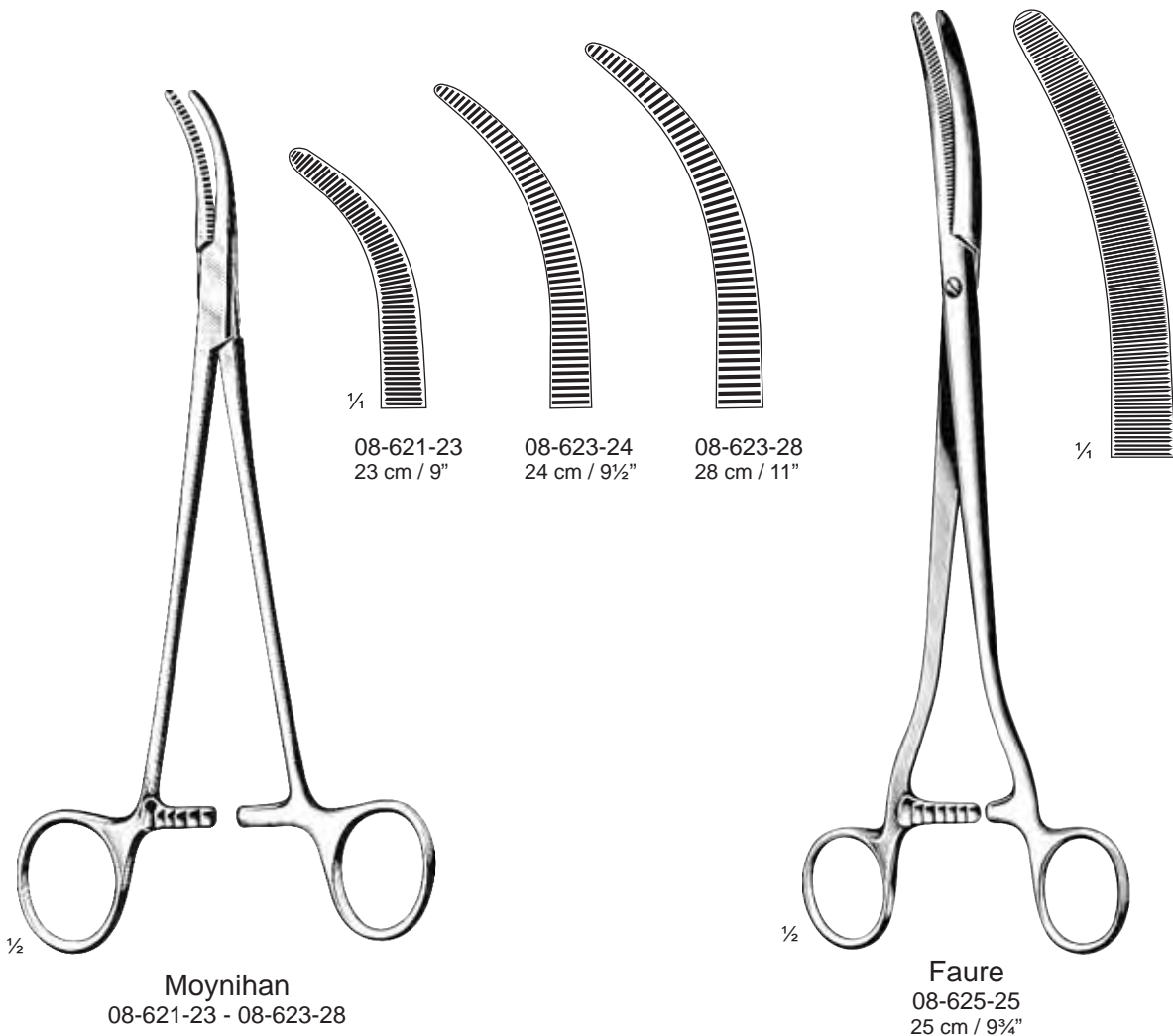

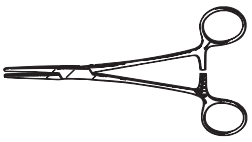

### Hysterectomy Forceps

Hysterektomieklemmen  
Pinzas para histerectomía

Pinces à hystérectomie  
Pinze per isterectomia

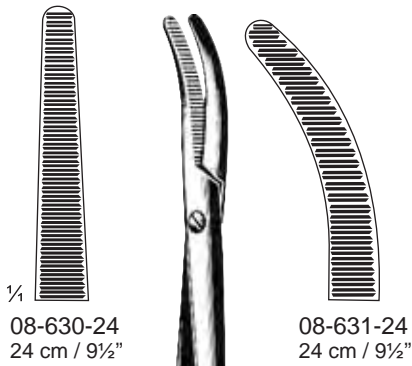

08-630-24  
24 cm / 9 1/2"

08-631-24  
24 cm / 9 1/2"



Segond-Landau  
08-630-24 - 08-631-24

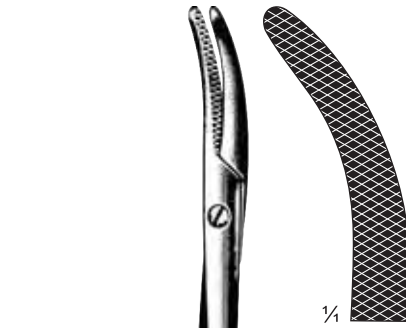

08-633-25  
25 cm / 9 3/4"



Wertheim  
08-633-25  
25 cm / 9 3/4"

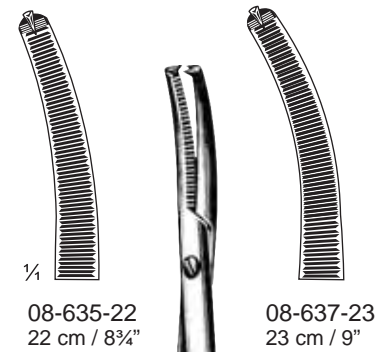

08-635-22  
22 cm / 8 3/4"

08-637-23  
23 cm / 9"



Wertheim  
08-635-22 - 08-637-23  
1:2 Teeth

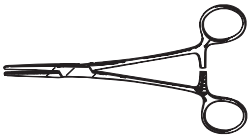

### Hysterectomy Forceps

Hysterektomieklemmen  
Pinzas para histerectomía

Pinces à hystérectomie  
Pinze per isterectomia

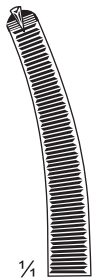

¼

08-641-22  
22 cm / 8¾"

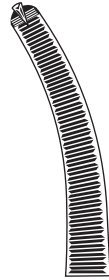

08-643-23  
23 cm / 9"

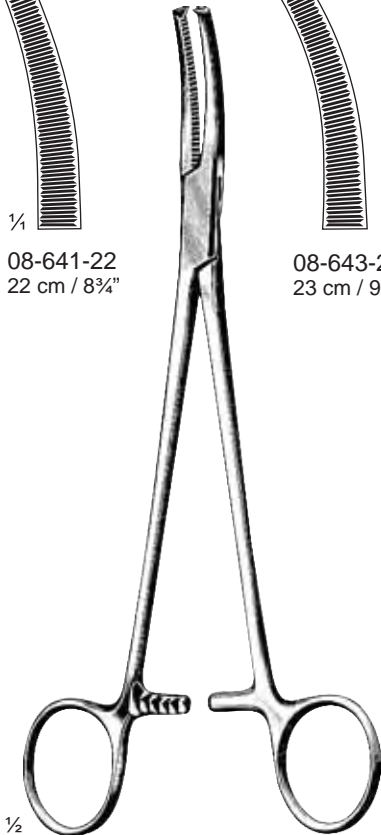

½

Wertheim  
08-641-22 - 08-643-23  
1:2 Teeth

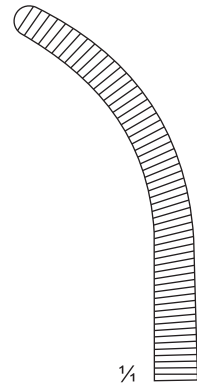

¼

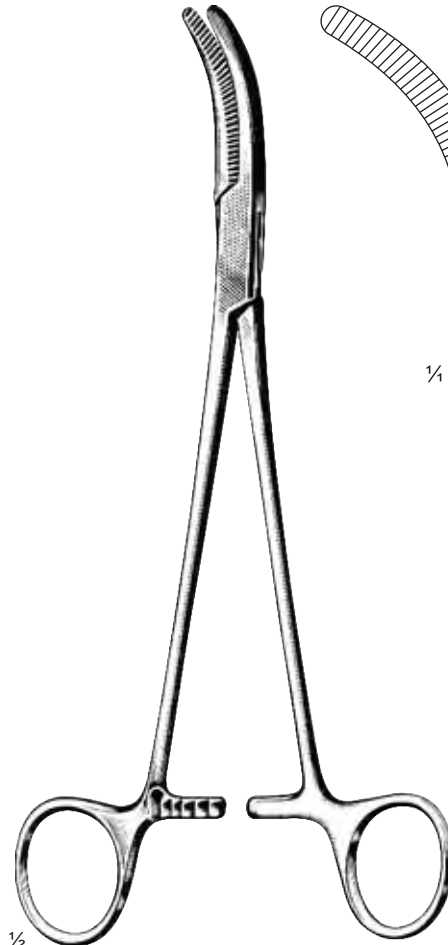

½

Wertheim  
08-645-25  
25 cm / 9¾"

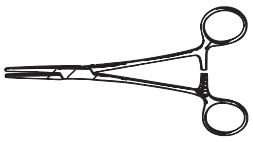

**Peritoneum Forceps**

Peritoneumklemmen  
Pinzas para peritoneo

Pince pour le péritoine  
Pinze per peritoneo

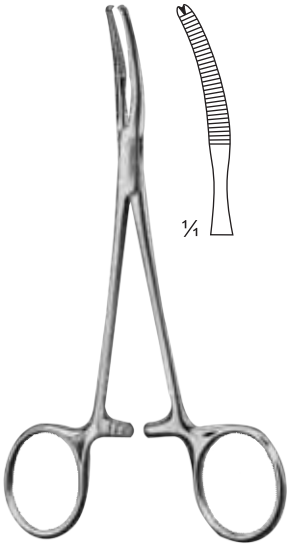

**Baby-Mikulicz**  
08-651-14  
14 cm / 5½"

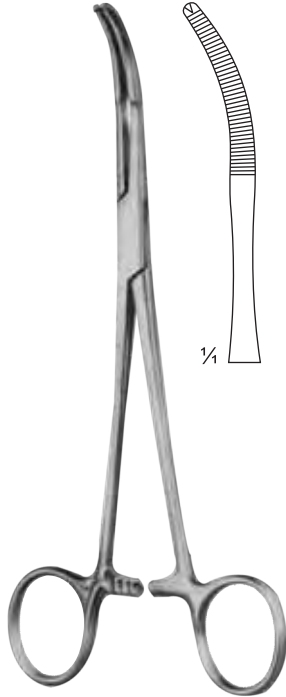

**Mikulicz**  
08-653-18  
18 cm / 7"

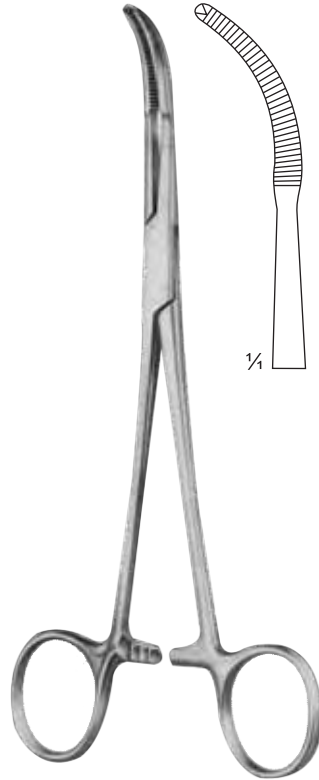

**Mikulicz**  
08-655-20  
20 cm / 8"

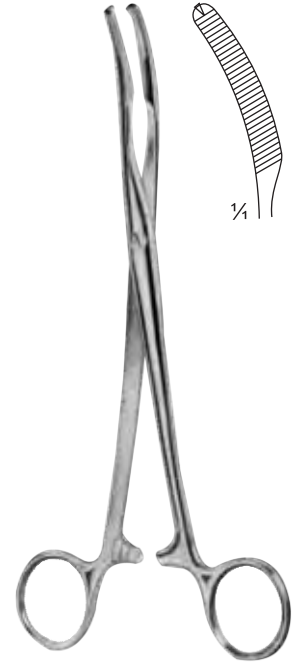

**Mikulicz**  
08-657-18  
18cm/7"

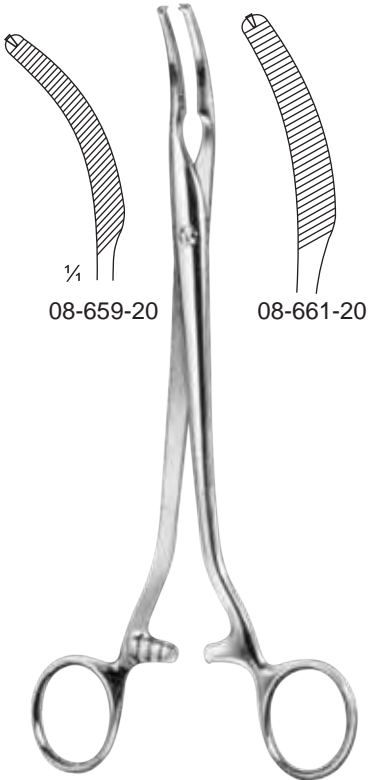

**Mikulicz**  
08-659-20 - 08-661-20  
20 cm / 8"

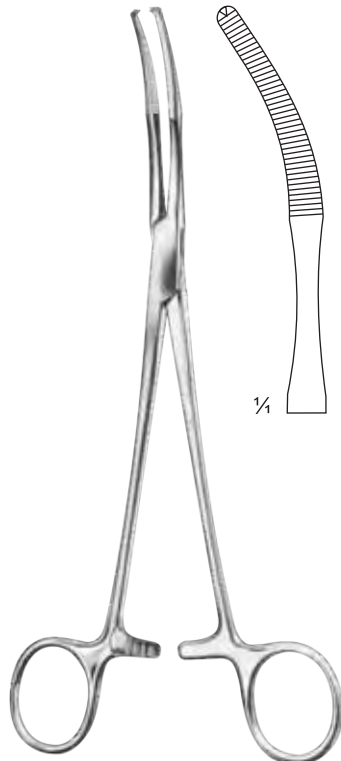

**Mikulicz**  
08-663-20  
20 cm / 8"

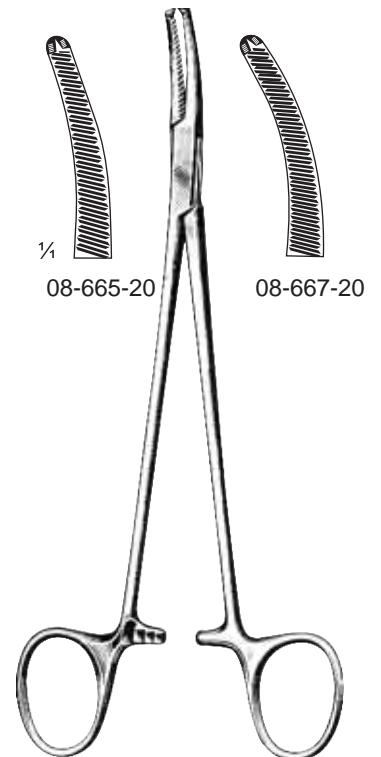

**Faure**  
08-665-20 - 08-667-20  
20 cm / 8"

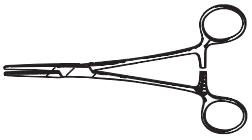

**Peritoneum Forceps**

Peritoneumklemmen  
Pinzas para peritoneo

Pince pour le péritoine  
Pinze per peritoneo



**Schindler**  
08-671-20  
20 cm / 8"  
1:2 teeth

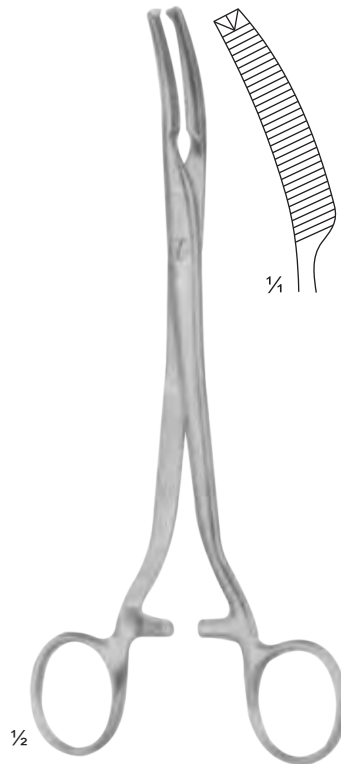

**Mikulicz**  
08-673-20  
20.5 cm / 8"  
1:2 teeth

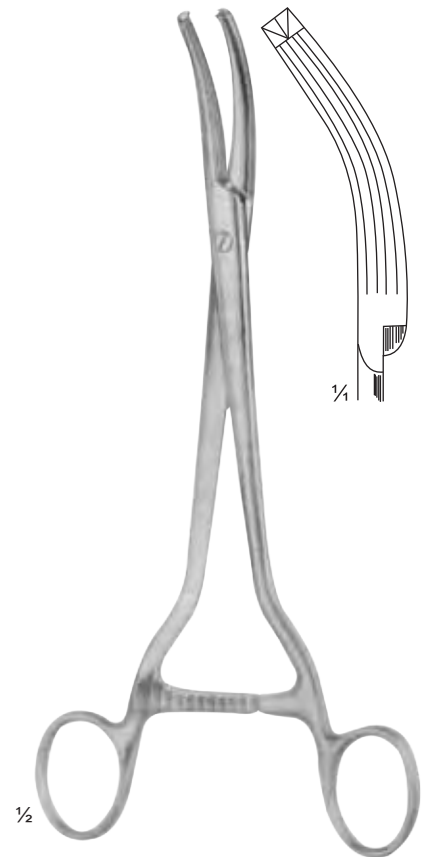

**Mikulicz**  
08-675-23  
23 cm / 9"  
1:2 teeth

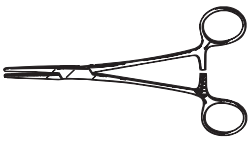

**Vaginal Clamps**

Vaginalklemmen  
Pinzas vaginal

Pinces vaginales  
Pinza vaginale

**ATRAUMA**



1/2

**Wertheim**

08-681-06 - 08-681-10  
24 cm / 9 1/2"

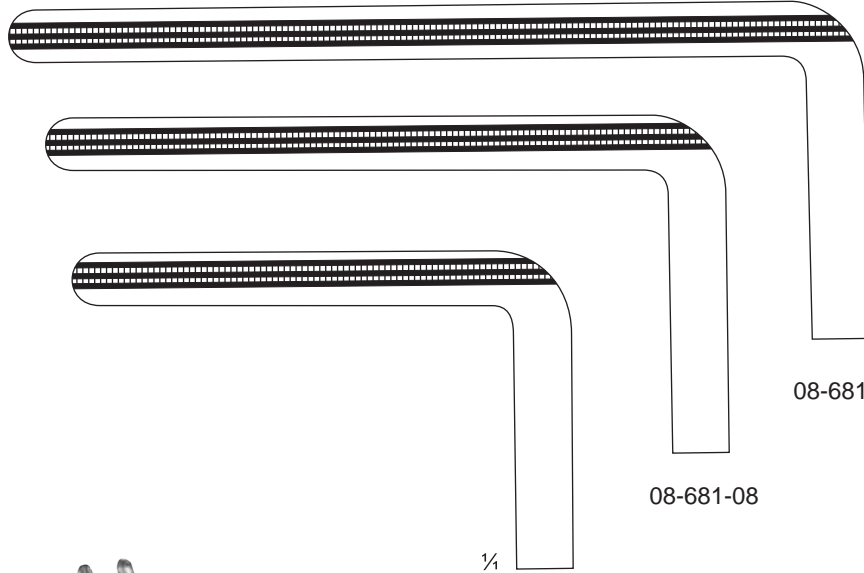

08-681-10

08-681-08

1/4

08-681-06



1/2

**Dick**

08-683-25 - 08-683-27

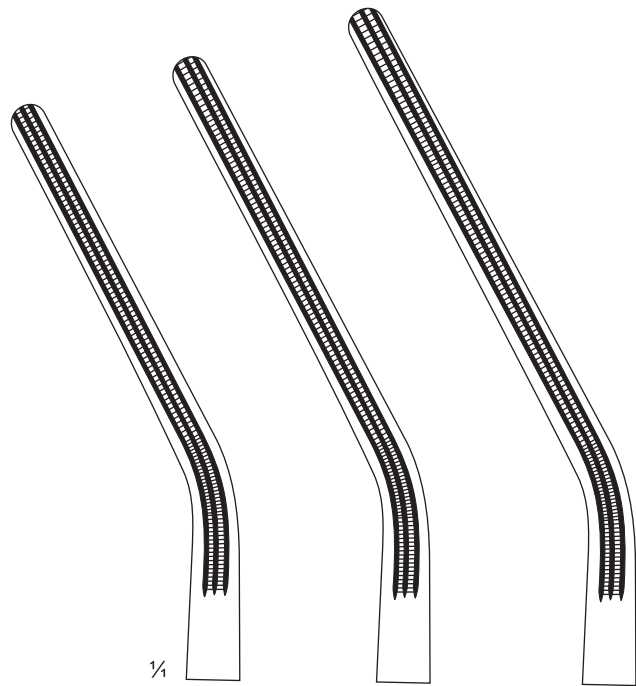

1/4

08-683-25  
25 cm / 9 3/4"

08-683-26  
26 cm / 10 1/4"

08-683-27  
27 cm / 10 3/4"

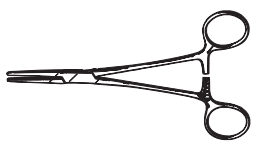

### Towel Clamps

Tuchklemmen  
Pinzas de campo

Pinces à champs  
Pinze fissatele



½

Engl. Modell  
08-689-09  
9 cm / 3½"



½

Jones  
08-691-05 = 5 cm / 2"  
08-691-09 = 9 cm / 3½"



½

Schaedel  
08-693-05 = 5 cm / 2"  
08-693-09 = 9 cm / 3½"



½

Jones  
08-695-09  
9 cm / 3½"  
with Clip for Tubing or Cable

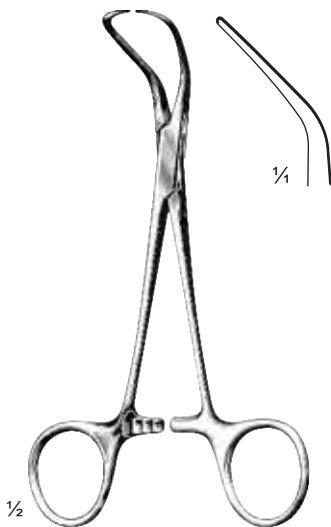

½

Backhaus  
08-697-08 = 8 cm / 3¼"  
08-697-11 = 11.5 cm / 4½"  
08-697-13 = 13 cm / 5"  
08-697-15 = 15 cm / 6"



½

Backhaus  
08-699-11  
11.5 cm / 4½"  
with Clip for Tubing or Cable



½

Backhaus  
08-701-11 = 11.5 cm / 4½"  
08-701-13 = 13 cm / 5"  
delicate pattern



½

Roeder  
08-703-13 = 13 cm / 5"  
08-703-15 = 15 cm / 6"

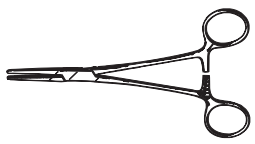

**Towel Clamps**

Tuchklemmen  
Pinzas de campo

Pinces à champs  
Pinze fissatele

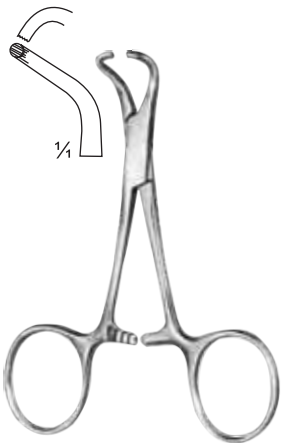

**Tohoku-Japan**  
08-709-10 = 10 cm / 4"  
08-709-13 = 13 cm / 5"

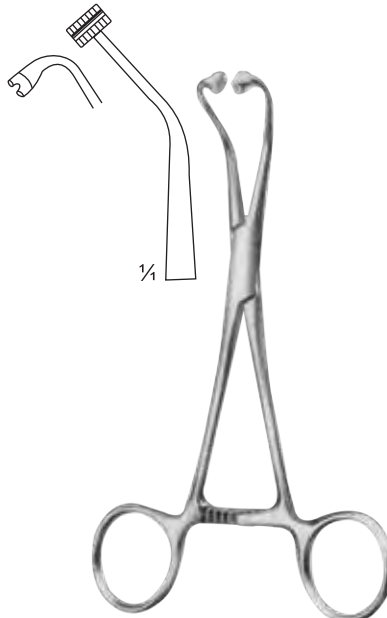

**Peers-Bertram™**  
08-711-14  
14.5 cm / 5 3/4"

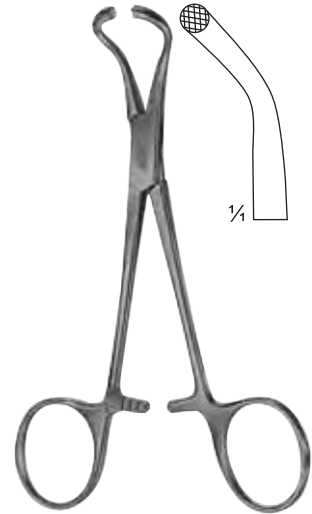

08-714-13  
13.5 cm / 5 1/4"  
for paper cloths

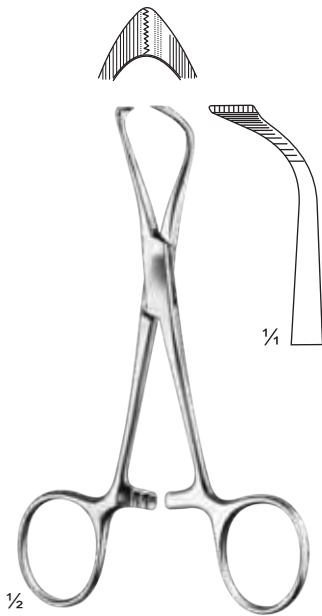

**Lorna**  
08-717-10 = 10 cm / 4"  
08-717-13 = 13 cm / 5"



**Bernhard-Staude**  
08-719-16  
16 cm / 6 1/4"

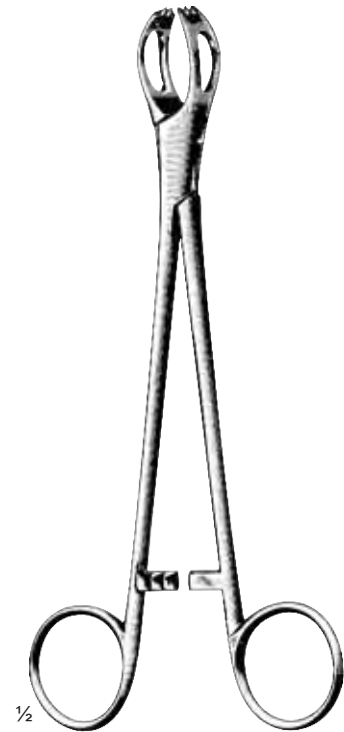

**Lane**  
08-721-16 = 16 cm / 6 1/4"  
08-721-18 = 18 cm / 8"  
08-721-20 = 20 cm / 8"



**Towel Clamps, Tube milking rollers**

Tuchklemmen, Rollenklemmen  
Pinzas de campo, Pinzas de rodillos

Pinces à champs, Pinces à roulette  
Pinze fissatele, Pinze con rotelle

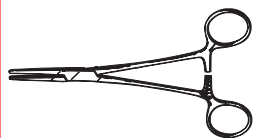

1/2  
**Doyen**  
08-727-11  
11 cm / 4 1/4"



1/2  
**Doyen**  
08-729-18  
18 cm / 7"



**Ball & Socket**  
11.5 cm / 4 1/2" = 08-731-11  
13 cm / 5" = 08-731-13



08-733-13  
13 cm / 5"  
(Non Tear)



**Moynihan**  
08-735-19  
19 cm / 7 1/2"



**Robin (Anchoring)**  
13.5 cm / 5 1/4"  
08-738-13 (For diathermy cable, 5mm dia)  
08-739-13 (For drainage tube, 13mm dia)  
08-740-13 (For anaesthetic tube, 25mm dia)



**Foss**  
08-743-18  
18 cm / 7"  
(Tube Milking)



**Gunner**  
08-745-18  
18 cm / 7"  
(Tube Milking)

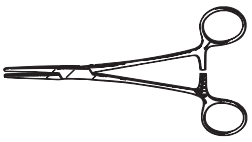

### Tubing Clamps

Schlauchklemmen  
Pinzas para tubos

Pinces presse-tubes  
Pinze serratubi

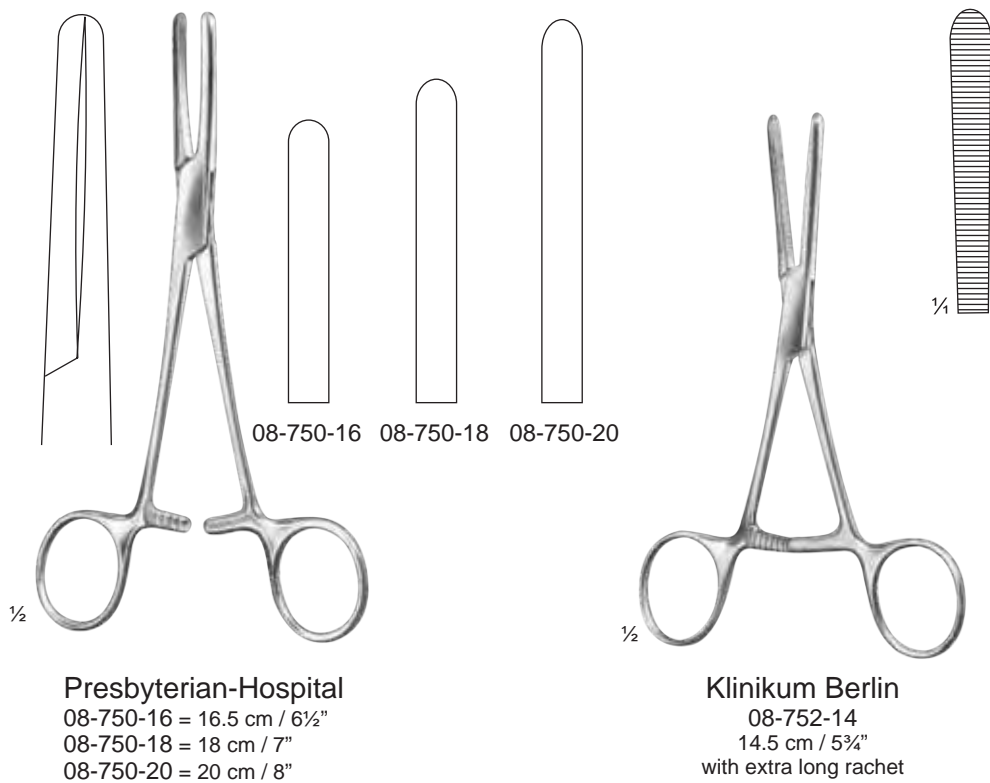

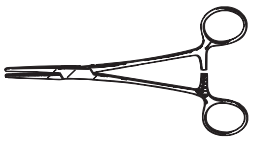

**Tubing Clamps**

Schlauchklemmen  
Pinzas para tubos

Pinces presse-tubes  
Pinze serratubi



Schoenberg  
Standard  
08-756-15 - 08-756-20

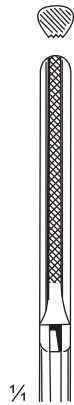

08-756-15  
15 cm / 6"



08-756-18  
18 cm / 7"

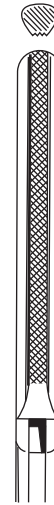

08-756-20  
20 cm / 8"



Schoenberg  
with safety guard  
08-758-15 - 08-758-20

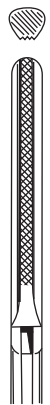

08-758-15  
15 cm / 6"

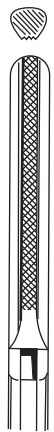

08-758-18  
18 cm / 7"

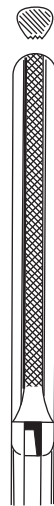

08-758-20  
20 cm / 8"



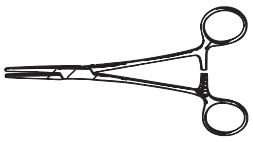

**Tubing Clamps**

Schlauchklemmen  
Pinzas para tubos

Pinces presse-tubes  
Pinze serratubi

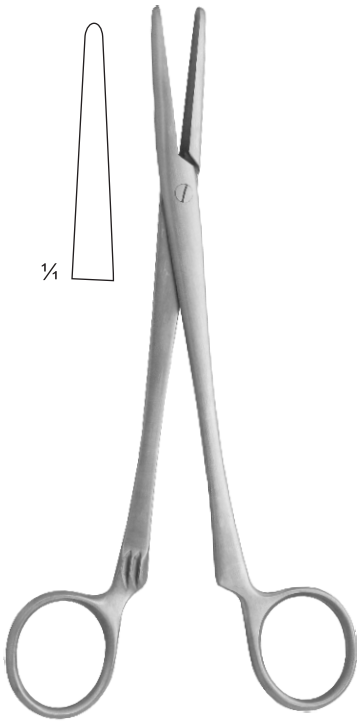

**Sully-Hosp**  
08-764-13 = 13 cm / 5"  
08-764-18 = 18 cm / 7"  
08-764-20 = 20 cm / 8"



**St. Bart**  
08-767-15  
15 cm / 6"



08-770-13  
13 cm / 5"  
(Plain Straight)



08-773-12  
12 cm / 4 3/4"  
(Plain Angled)



**Plain Jaws**  
08-776-18  
18 cm / 7"  
(Strong Model)



**Angled, Plain**  
08-779-15  
15 cm / 6"  
(Strong Model)