

**Falcon**<sup>®</sup>

Surgical  
Instruments



14

SUTURE

NAHT  
SUTURA  
SUTURE  
SUTURA

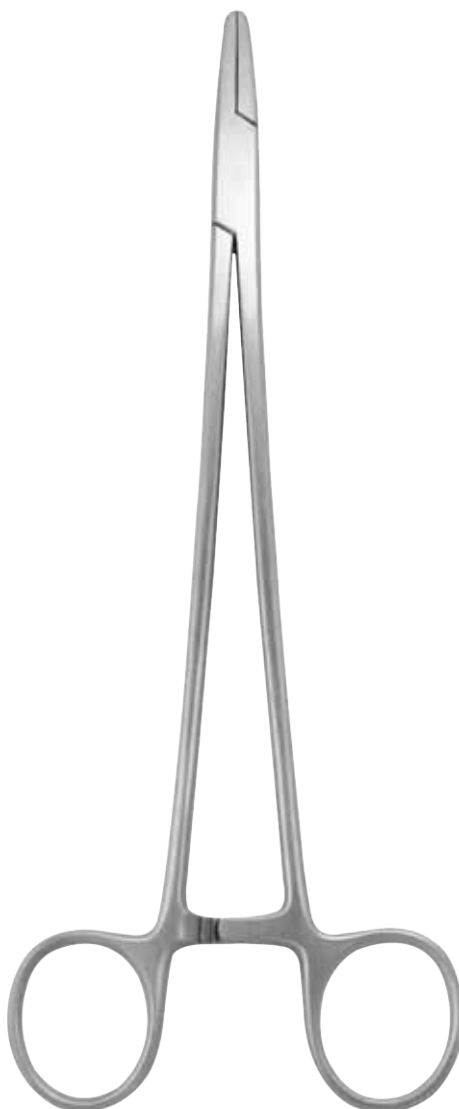



**Micro Needle Holders**

Mikro-Nadelhalter  
Micro Porta-agujas

Micro porte-aiguilles  
Micro Portaghi

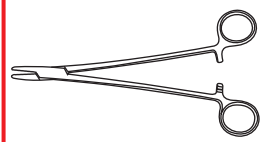

**Stevens (Silcock)**  
14-002-13 = 13 cm / 5"  
14-002-15 = 15 cm / 6"



**Potts-Smith**  
14-004-22  
22 cm / 8 3/4"



**Paton**  
14-006-11      14-007-11  
11 cm / 4 1/4"      11 cm / 4 1/4"  
Straight      curved



**Barraquer**  
14-010-14  
14 cm / 5 1/2"



**Kalt**  
14-012-14  
14 cm / 5 1/2"



**Castroviejo-Kalt**  
14-014-14  
13.5 cm / 5 1/4"



**Kalt-Arruga**  
14-017-14  
14 cm / 5 1/2"

**Micro Needle Holders**

Mikro-Nadelhalter  
Micro Porta-agujas

Micro porte-aiguilles  
Micro Portaghi

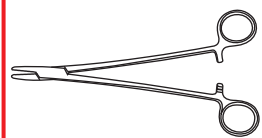

14-022-18



14-023-18



1/2

14-022-18 - 14-023-18  
18 cm / 7 1/4"



14-026-18



14-027-18



1/2

14-026-18 - 14-027-18  
18 cm / 7 1/4"



14-030-23  
23 cm / 9"



14-031-23  
23 cm / 9"



14-033-19  
19 cm / 7 1/2"



1/2

14-030-23 - 14-033-19

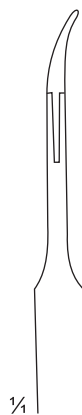

14-035-14

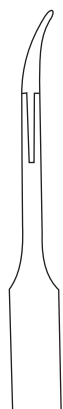

14-037-14



1/2

**Gomel**  
14-035-14 - 14-037-15  
14 cm / 5 1/2"



14-037-15

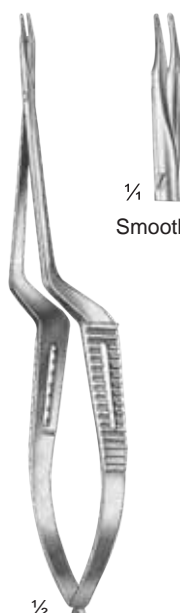

1/2

14-039-16  
16 cm / 6 1/4"



1/4  
Smooth jaws



1/4



**Boynton**  
14-042-12  
12 cm / 4 3/4"

**Micro Needle Holders**

Mikro-Nadelhalter  
Micro Porta-agujas

Micro porte-aiguilles  
Micro Portaghi

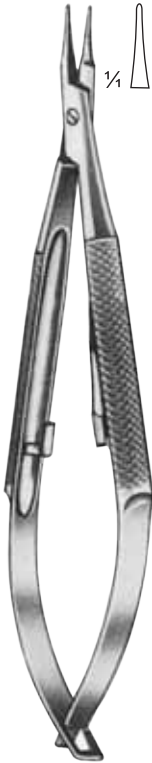
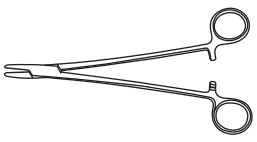

**Barraquer-Troutman**  
14-048-10  
10 cm / 4"

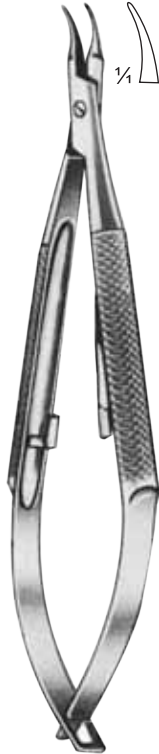

**Barraquer-Troutman**  
14-051-10  
10 cm / 4"



**Barraquer-Troutman**  
14-054-10  
10 cm / 4"

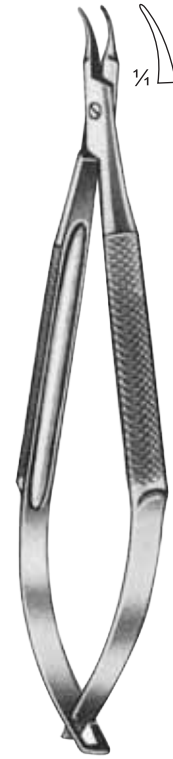

**Barraquer-Troutman**  
14-057-10  
10 cm / 4"



**Barraquer**  
14-060-11  
11.5 cm / 4½"



**Barraquer**  
14-062-13  
13 cm / 5"



**Barraquer**  
14-065-14  
14 cm / 5½"



**Barraquer**  
14-068-14  
14 cm / 5½"



**Barraquer**  
14-070-14  
14 cm / 5½"

**Micro Needle Holders**

Mikro-Nadelhalter  
Micro Porta-agujas

Micro porte-aiguilles  
Micro Portaghi

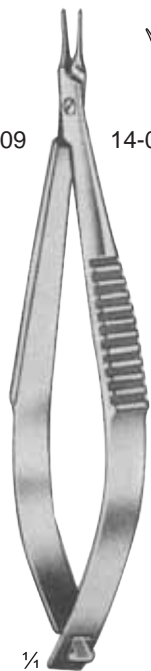
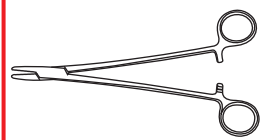

**Castroviejo**  
14-074-09- 14-075-09  
9 cm / 3 1/2"

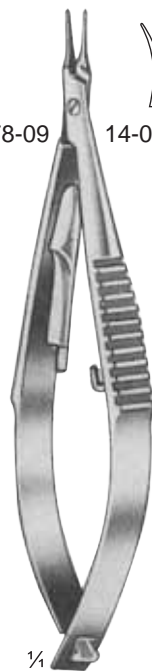
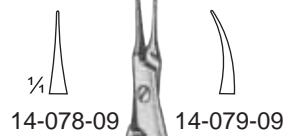

**Castroviejo**  
14-078-09 - 14-079-09  
9 cm / 3 1/2"

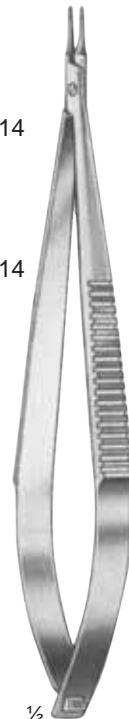
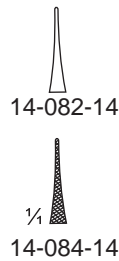

**Castroviejo**  
14-082-14 - 14-085-14  
14 cm / 5 1/2"

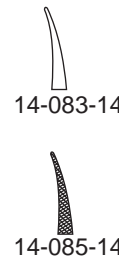

**Castroviejo**  
14-088-14 - 14-091-14  
14 cm / 5 1/2"

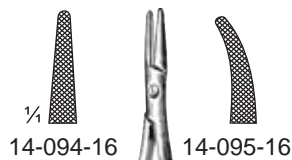

**Arruga**  
14-094-16 - 14-095-16  
16 cm / 6 1/4"

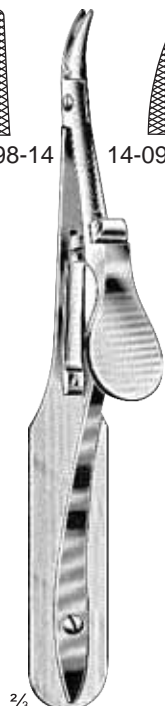
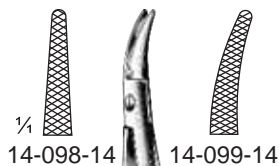

**Arruga**  
14-098-14 - 14-099-14  
14 cm / 5 1/2"



**Castroviejo**  
14-102-13  
13 cm / 5 1/4"

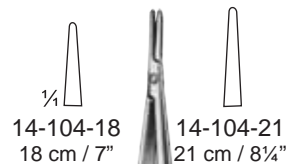

**Jacobson**  
14-104-18 - 14-104-21



**Castroviejo-Barraquer**  
14-107-12  
12 cm / 4 3/4"

**Needle Holders**

Nadelhalter  
Porta-agujas

Porte-aiguilles  
Portaghi

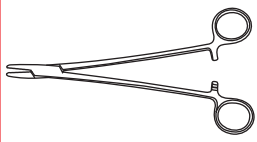

Smooth jaws, with special groove

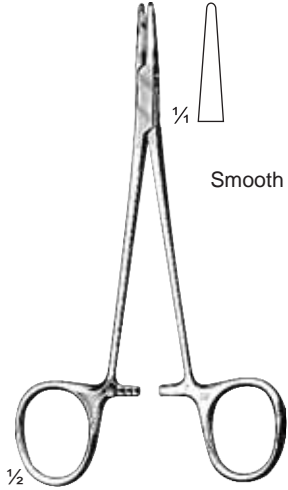

**Halsey**  
14-112-13  
13 cm / 5"



**Neivert**  
14-114-13  
13 cm / 5"



**Hegar-Baumgartner**  
14-116-14  
14 cm / 5½"



**Brown**  
14-118-13 = 13 cm / 5"  
14-118-18 = 18 cm / 7"

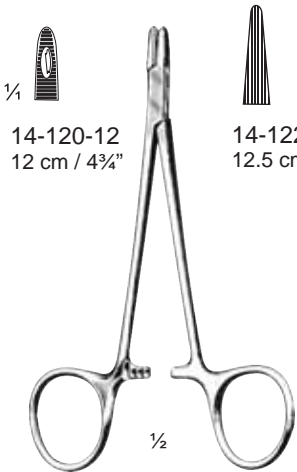
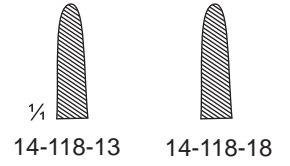

**Derf**  
14-120-12 - 14-122-12

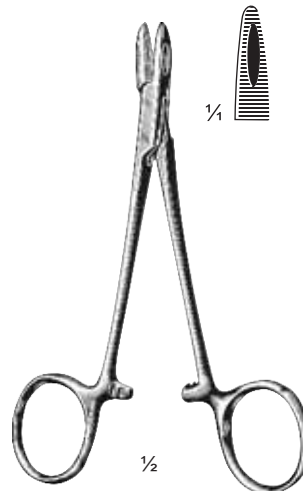

**Collier**  
14-124-12  
12.5 cm / 5"

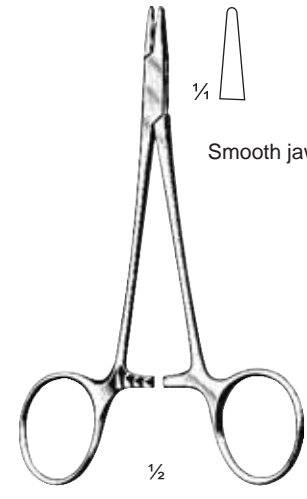

**Webster**  
14-126-13  
13 cm / 5"

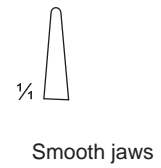

**Needle Holders**

Nadelhalter  
Porta-agujas

Porte-aiguilles  
Portaghi

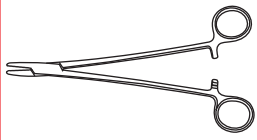

**M.G.H.**  
(Mass.-General-Hospital)  
14-130-17  
17 cm / 6 3/4"

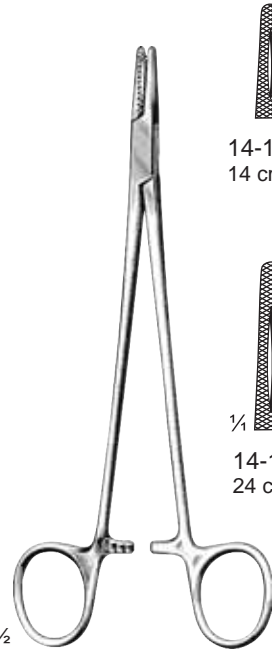

**Mayo-Hegar**  
14-132-14 - 14-132-30

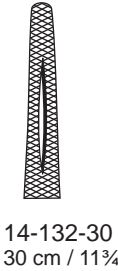
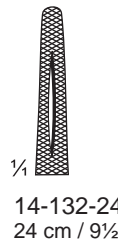
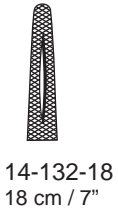
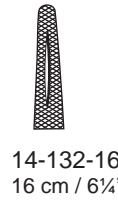
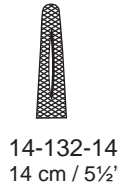

**Lawrance**  
14-136-15  
15 cm / 6"

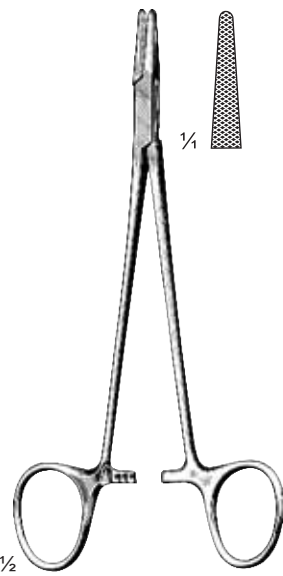

**Crile-Murray**  
14-138-15  
15 cm / 6"

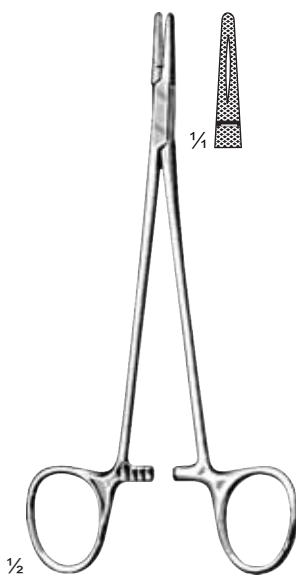

**Crile-Wood**  
14-140-15 = 15 cm / 6"  
14-140-18 = 18 cm / 7"



**Baby Crile-Wood**  
14-142-15  
15 cm / 6"



**Carrol**  
14-144-15  
15 cm / 6"



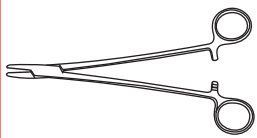

**Needle Holders**

Nadelhalter  
Porta-agujas

Porte-aiguilles  
Portaghi

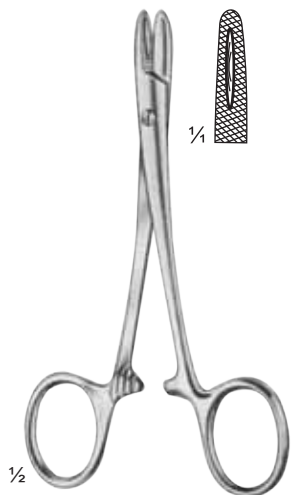

**Doyen**  
14-150-12  
12.5 cm / 5"

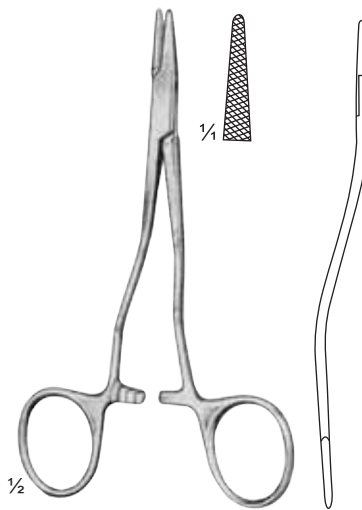

**Kilner**  
14-153-13 = 13.5 cm / 5 1/4"  
14-153-16 = 16.5 cm / 6 1/2"



**Bruce-Clark**  
14-156-13  
13 cm / 5"



**Wright**  
14-158-13  
13 cm / 5"



**Dott**  
14-160-14  
14 cm / 5 1/2"



**New Orleans**  
14-162-18  
18 cm / 7"

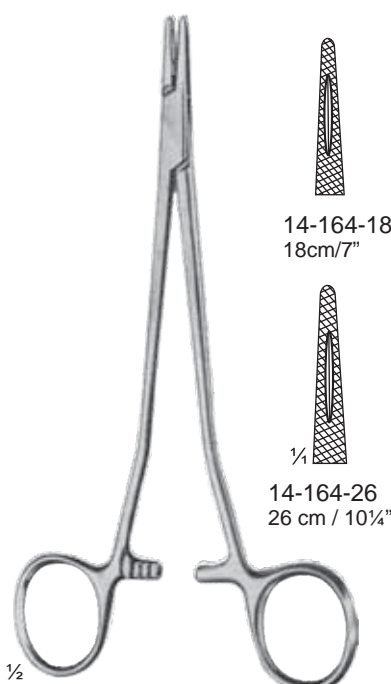

**Sarot**  
14-164-18 - 14-164-26

14-164-18  
18cm/7"

14-164-26  
26 cm / 10 1/4"

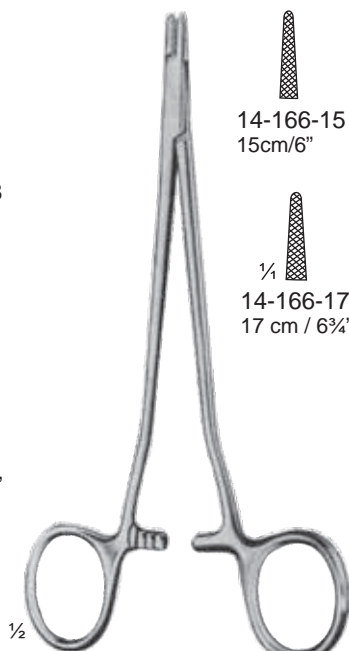

**Senning**  
14-166-15 - 14-166-17  
(Schwed. Model)

14-166-15  
15cm/6"

14-166-17  
17 cm / 6 3/4"

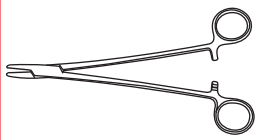

**Needle Holders**

Nadelhalter  
Porta-agujas

Porte-aiguilles  
Portaghi

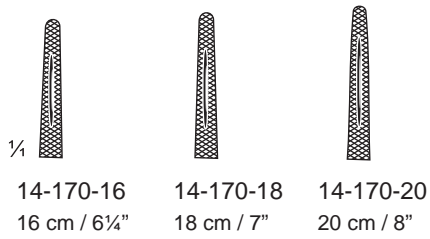
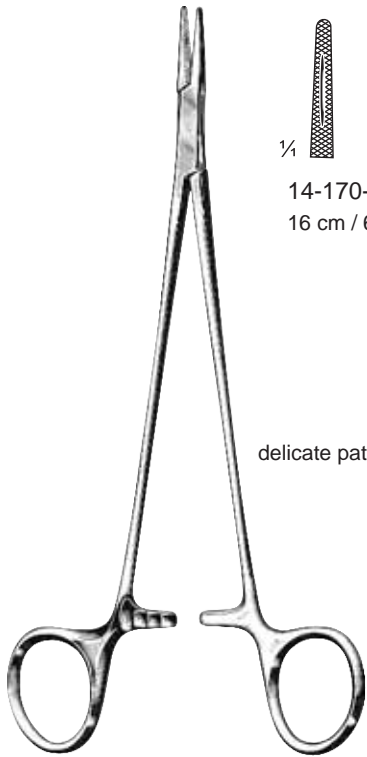

delicate pattern

**Mayo-Hegar**  
14-170-16 - 14-170-20

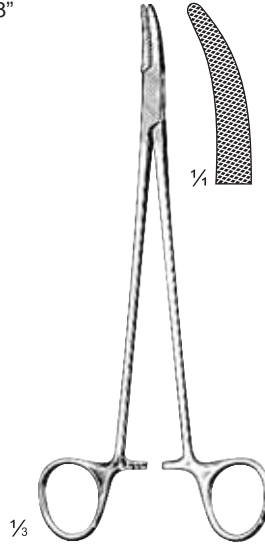

**Heaney**  
14-173-21  
21 cm / 8 1/4"

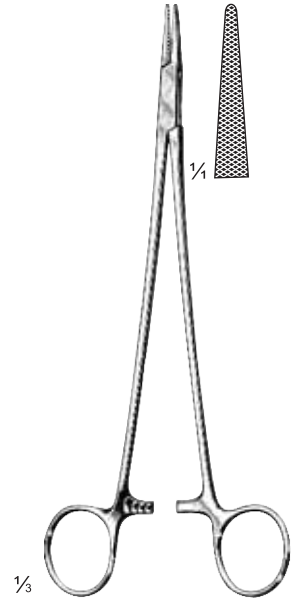

**Jamison**  
14-174-23  
23.5 cm / 9 1/4"



**Adson**  
14-176-18  
18 cm / 7"



**Metzenbaum**  
14-178-18  
18 cm / 7"

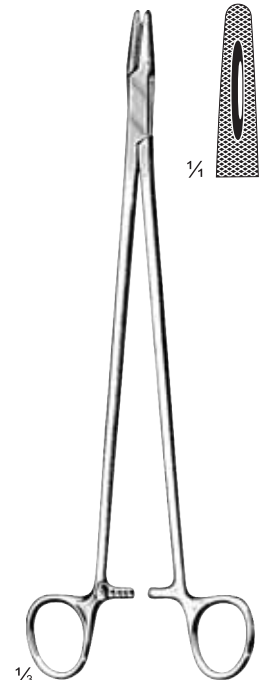

**Masson**  
14-180-27  
26.5 cm / 10 1/2"

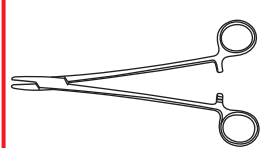

**Needle Holders**

Nadelhalter  
Porta-agujas

Porte-aiguilles  
Portaghi

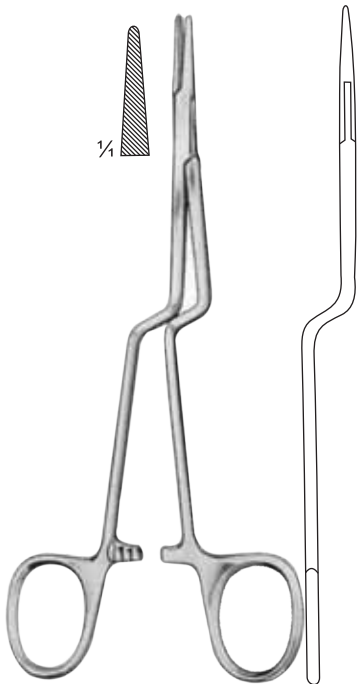

**Jacobson**  
14-183-18  
18 cm / 7"

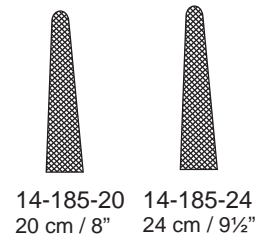
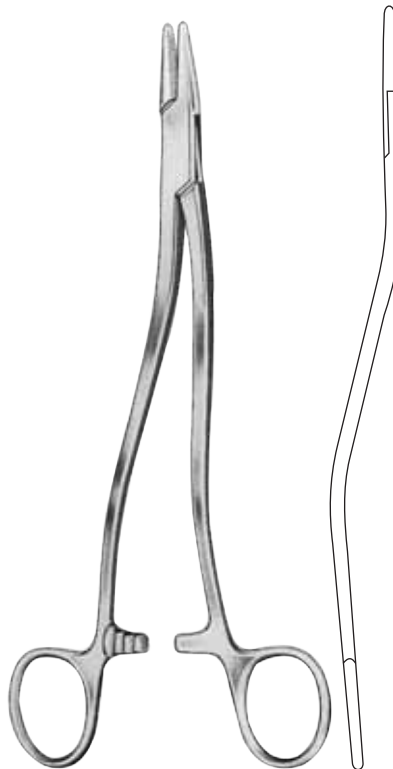

**Bozemann**  
14-185-20 - 14-185-26

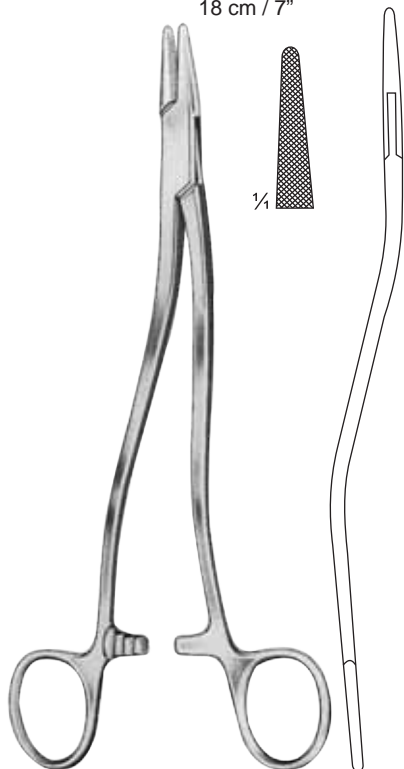
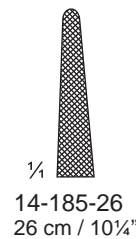

**Thomson-Walker**  
14-187-20  
20 cm / 8"

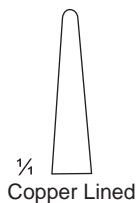

**Bozemann**  
14-189-20  
20 cm / 8"



**Sims**  
14-192-19  
19 cm / 7 1/2"



**Sims**  
14-195-19  
19 cm / 7 1/2"

**Needle Holders**

Nadelhalter  
Porta-agujas

Porte-aiguilles  
Portaghi

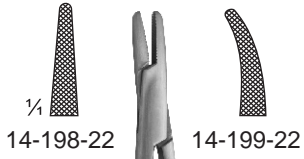
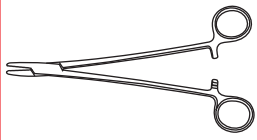

**Turner Warwick**  
14-198-22 - 14-199-22  
22 cm / 8 3/4"



**Hunt**  
14-202-19  
19 cm / 7 1/2"

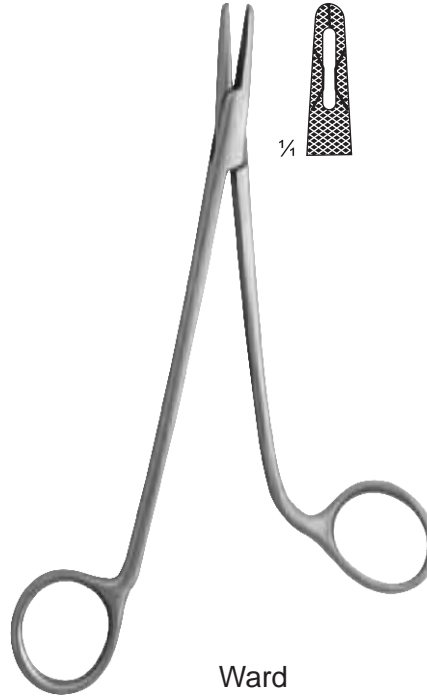

**Ward**  
14-204-18  
18 cm / 7"

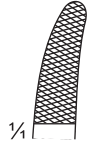

**Swift-Jolly**  
14-206-20  
20 cm / 8"



**Hodlick**  
14-209-18  
18 cm / 7"



**Masson-Luethy**  
14-211-26  
26 cm / 10 1/4"



**Blalock**  
14-214-20 = 20 cm / 8"  
14-214-27 = 27 cm / 10 3/4"



**Richter**  
14-216-16  
16.5 cm / 6 1/2"

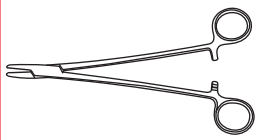

**Needle Holders**

Nadelhalter  
Porta-agujas

Porte-aiguilles  
Portaghi



**Finocchio**  
14-225-27  
26.5 cm / 10 1/2"

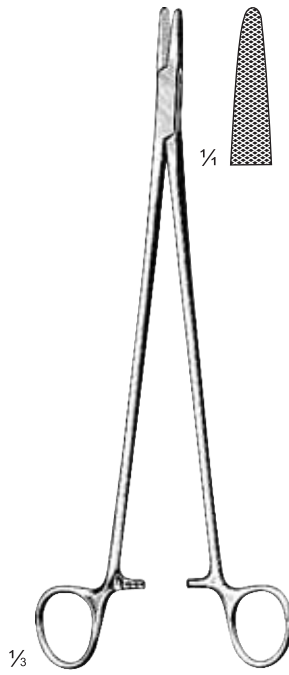

**Wangenstein**  
14-228-27  
26.5 cm / 10 1/2"

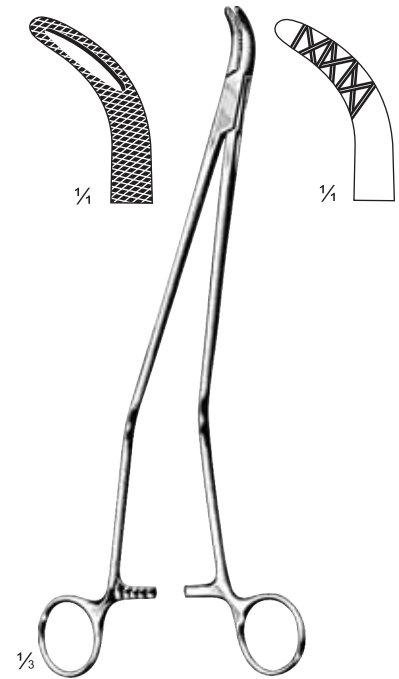

**Johnson**  
14-231-27  
27 cm / 10 3/4"

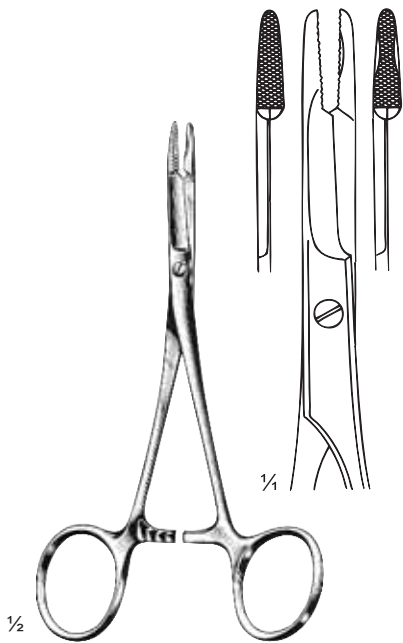

**Olsen-Hegar**  
14-234-14  
14 cm / 5 1/2"

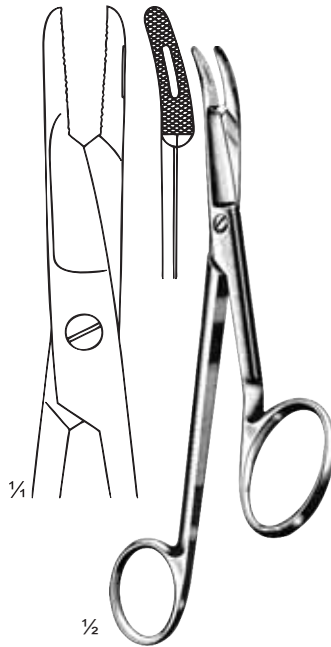

**Gilies**  
14-236-16 - 14-237-16  
16 cm / 6 1/4"  
(Left) (Right)



**Crile**  
14-240-15  
15 cm / 6"

**Needle Holders**

Nadelhalter  
Porta-agujas

Porte-aiguilles  
Portaghi

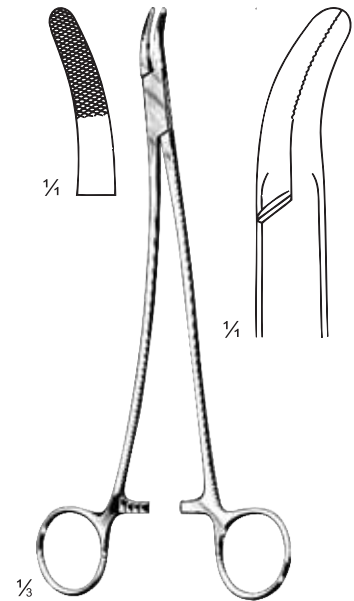

**Stratte**  
14-245-23  
23 cm / 9"

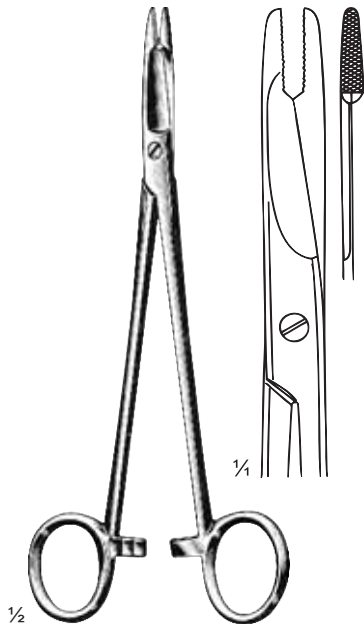

**Olsen-Hegar**  
14-248-17  
17 cm / 6 3/4"

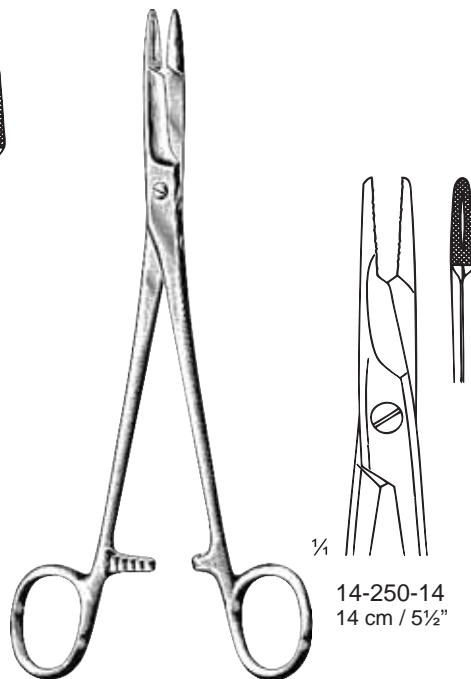

**Olsen-Hegar**  
14-250-14 - 14-250-18

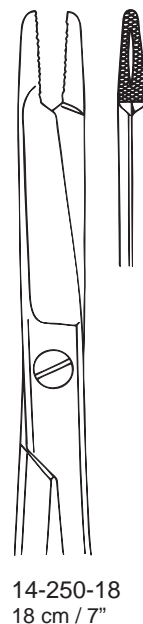

14-250-18  
18 cm / 7"

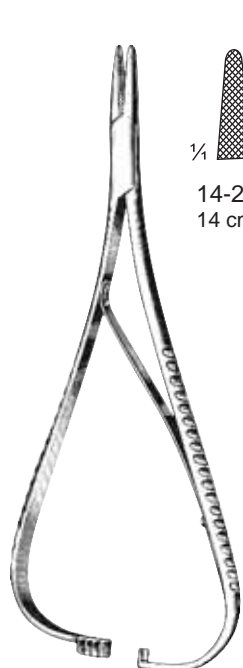

**Mathieu**  
14-252-14 - 14-252-20

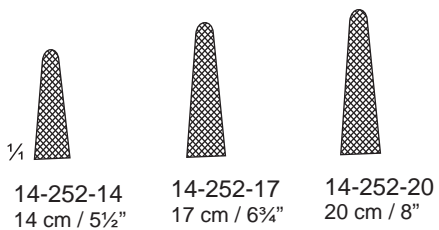

**Mathieu**  
14-254-14 - 14-254-17

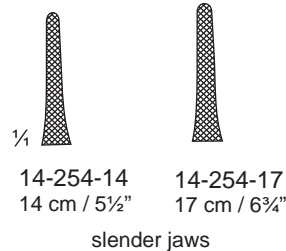

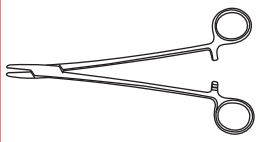

**Needle Holders**

Nadelhalter  
Porta-agujas

Porte-aiguilles  
Portaghi

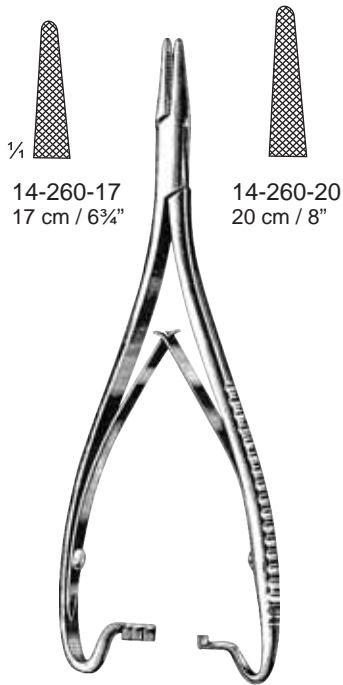

14-260-17  
17 cm / 6¾"

14-260-20  
20 cm / 8"

**Mathieu**  
14-260-17 - 14-260-20



½

**Toennis**  
14-262-18  
18 cm / 7"



½

**Lichtenberg**  
14-264-20  
20 cm / 8"

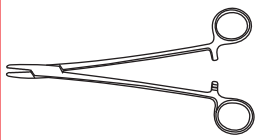

**Needle Holders**

Nadelhalter  
Porta-agujas

Porte-aiguilles  
Portaghi

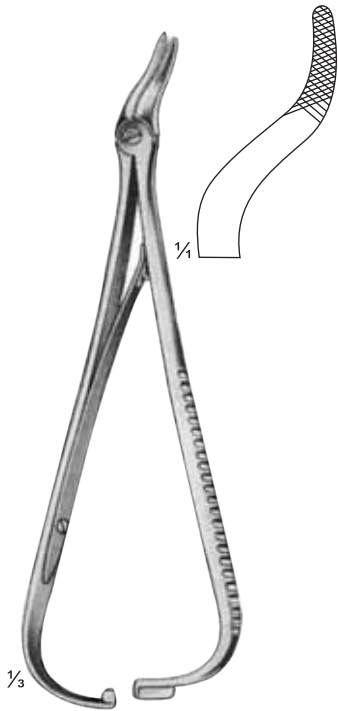

**Eiselsberg-Mathieu**  
14-268-18  
18.5 cm / 7 1/4"



**Zweifel**

1/4  
14-270-20  
20 cm / 8"

14-270-23  
23 cm / 9"



Copper Lined  
14-273-14

1/4  
Copper Lined  
14-273-17

**Macphail**  
14-273-14 = 14 cm / 5 1/2"  
14-273-17 = 17 cm / 6 3/4"  
14-273-20 = 20 cm / 8"



**Langenbeck**

14-276-16  
16 cm / 6 1/4"

14-276-18  
18 cm / 7"

1/4  
14-276-20  
20 cm / 8"



**Hösel**  
14-278-25  
25 cm / 9 3/4"



**Needle Holders**

Nadelhalter  
Porta-agujas

Porte-aiguilles  
Portaghi

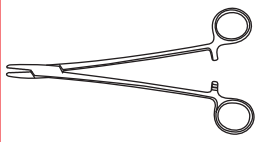

**Halstead-Cushing**  
14-284-22  
22 cm / 8½"

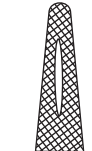
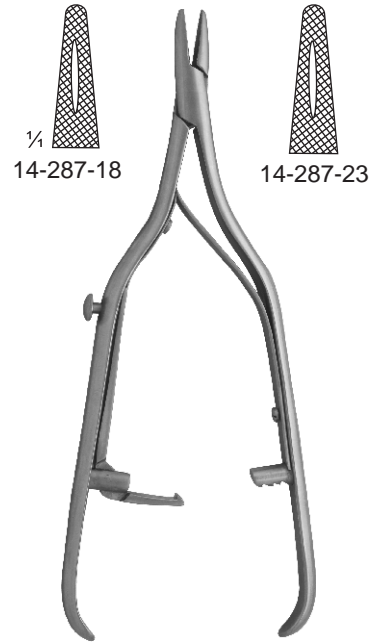

14-287-18

14-287-23

**Mayo-Rochester**  
14-287-18 = 18 cm / 7"  
14-287-23 = 23 cm / 9"



14-290-20  
20 cm / 8"

14-291-25  
25.5 cm / 10"

**Mathieu**  
14-290-20 - 14-291-25



14-294-18

14-294-25

**Naunton Morgan**  
14-294-18 = 18 cm / 7"  
14-294-25 = 25.5 cm / 10"



**Müller**  
14-297-36  
36 cm / 14¼"

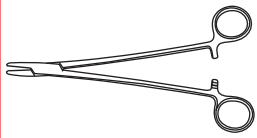

## Tungsten Carbide Tips with pyramidal Profile

Hartmetalleinsatzplättchen mit pyramidenprofil

Plaquettes en carbure de tungstène avec profil pyramidal

Bocas de carburo de tungsteno con perfil de estructura piramidal

Placche di carburo di tungsteno con profilo in forma piramidale

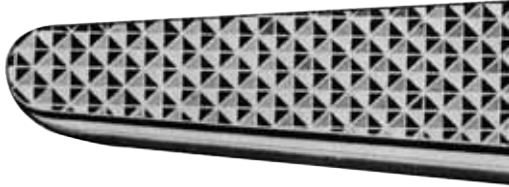

### Standard

(Mayo-Hegar, Mathieu, Bozeman  
New Orleans, Startte, etc.)

Serration: 0.5mm for suture sizes 3/0 and larger

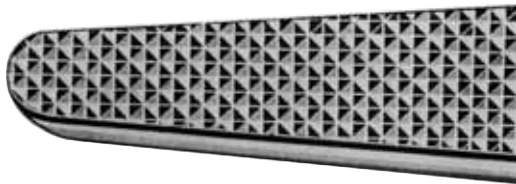

### Fine

(Crile-Wood, Halsey, Debaquey, Ryder, etc.)

Serration: 0.4mm For sutures sizes between 3/0 and 6/0

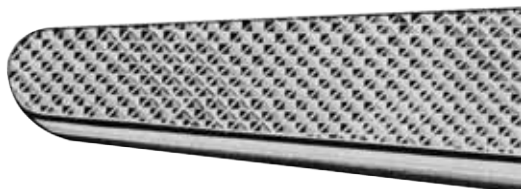

### Micro

(Micro-Ryder, Microvascular, Castroviejo, etc.)

Serration: 0.2mm For sutures sizes between 7/0 and 10/0

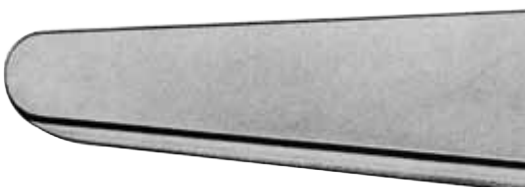

### Smooth

(Eufrate Pasque, Castroviejo, Jacobson, etc.)

smooth For the smallest suture sizes available

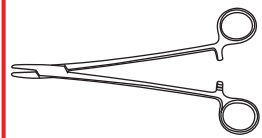

### Micro-Needle Holders with Tungsten Carbide Inserts

Mikro-Nadelhalter mit Hartmetalleinsätzen  
 Micro-Porta-agujas con bocas de carburo de Tungsteno

Micro-Porte-aiguilles à mors en carbure de tungstène  
 Micro-Portaghi con placche di carburo di tungsteno

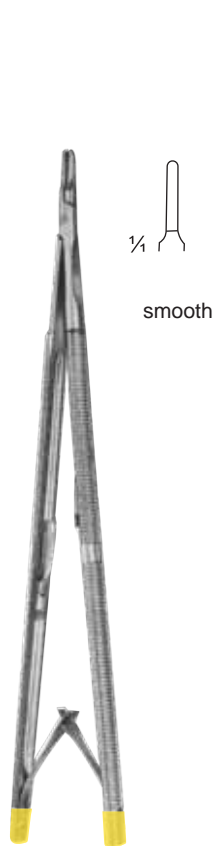

¼  
 smooth

**Hepp-Scheidel**  
 14-310-18  
 18 cm / 7"



¼

½  
**Potts-Smith**  
 14-312-22  
 22 cm / 8¾"

¼  
 14-314-01



¼  
 14-314-02

**Jacobson**  
 21 cm / 8¼"

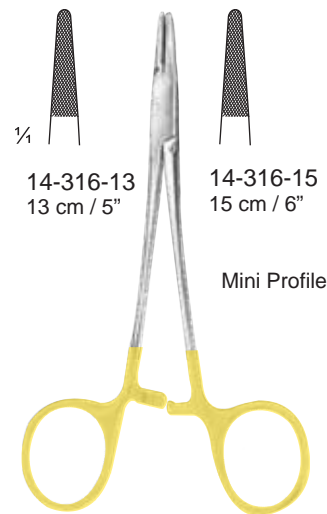

¼  
 14-316-13  
 13 cm / 5"

¼  
 14-316-15  
 15 cm / 6"

Mini Profile

14-316-13 - 14-316-15



¼  
 14-318-18  
 with lock

¼  
 14-319-18  
 with lock

¼  
 14-320-18  
 without lock

¼  
 14-321-18  
 without lock

**Vascular**  
 14-318-18 - 14-321-18  
 18 cm / 7"

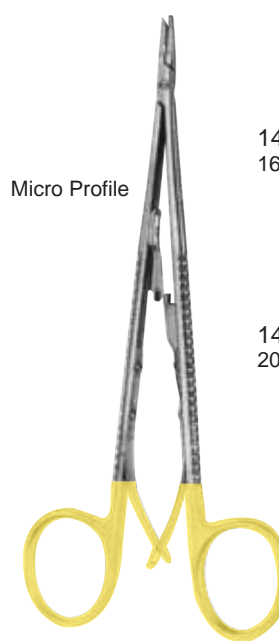

Micro Profile

¼  
 14-324-16  
 16 cm / 6¼"

¼  
 14-324-18  
 18 cm / 7"

¼  
 14-324-20  
 20 cm / 8"

¼  
 14-324-23  
 23 cm / 9"

¼  
 14-324-26  
 26 cm / 10¼"

**Diethrich**  
 14-324-16 - 14-324-26

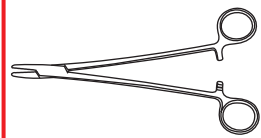

### Micro-Needle Holders with Tungsten Carbide Inserts

Mikro-Nadelhalter mit Hartmetalleinsätzen  
 Micro-Porta-agujas con bocas de carburo de Tungsteno

Micro-Porte-aiguilles à mors en carbure de tungstène  
 Micro-Portaghi con placche di carburo di tungsteno



14-330-14  
 14 cm / 5½"  
 smooth

14-331-14  
 14 cm / 5½"  
 smooth

**Castroviejo**  
 14-330-14 - 14-333-21



14-332-18  
 18 cm / 7"  
 Micro Profile



14-333-18  
 18 cm / 7"  
 Micro Profile

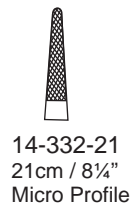

14-332-21  
 21cm / 8¼"  
 Micro Profile



14-333-21  
 21cm / 8¼"  
 Micro Profile



14-334-12

14-335-12

**Boynton**  
 12 cm / 4¾"

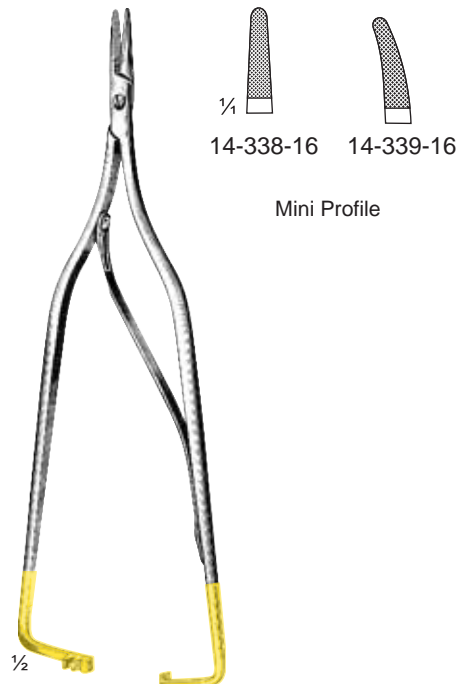

14-338-16

14-339-16

Mini Profile

**Arruga**  
 14-338-16 - 14-339-16  
 16 cm / 6¼"



**Castroviejo**  
 14-342-13  
 13 cm / 5"

glatt  
 smooth  
 lisa



**Barraquer**  
 14-344-13  
 13 cm / 5"

smooth



**Barraquer**  
 14-346-13  
 13 cm / 5"

smooth



**Kalt**  
 14-348-14  
 13.5 cm / 5¼"

smooth

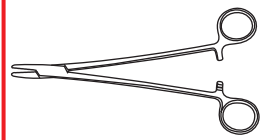

### Needle Holders with Tungsten Carbide Inserts

Nadelhalter mit Hartmetalleinsätzen  
Porta-agujas con bocas de carburo de Tungsteno

Porte-aiguilles à mors en carbure de tungstène  
Portaghi con placche di carburo di tungsteno

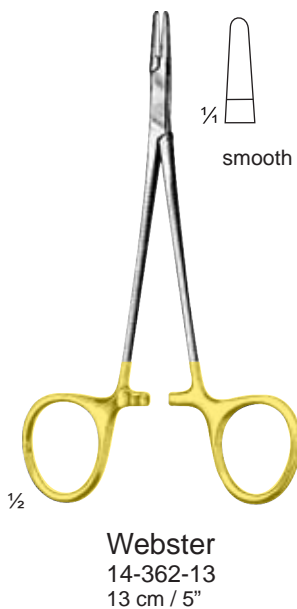

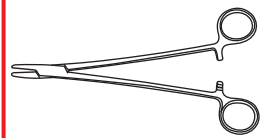

### Needle Holders with Tungsten Carbide Inserts

Nadelhalter mit Hartmetalleinsätzen  
Porta-agujas con bocas de carburo de Tungsteno

Porte-aiguilles à mors en carbure de tungstène  
Portaghi con placche di carburo di tungsteno

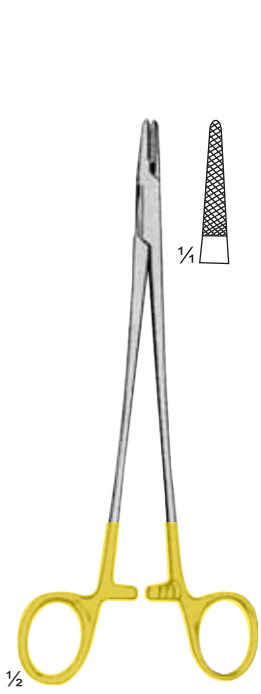

**Carrol**  
14-372-15  
15 cm / 6"

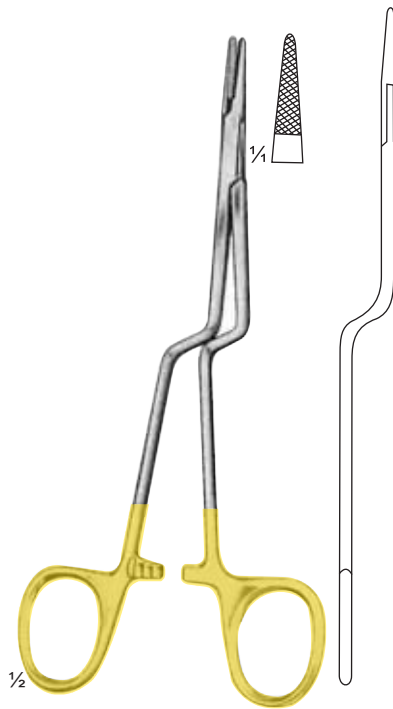

**Jacobson**  
14-374-18  
18 cm / 7"

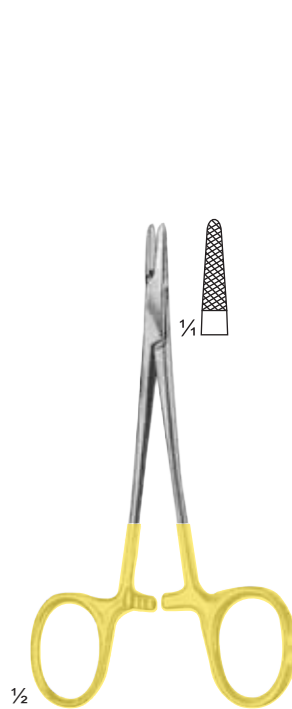

**Converse**  
14-376-12  
12.5 cm / 5"

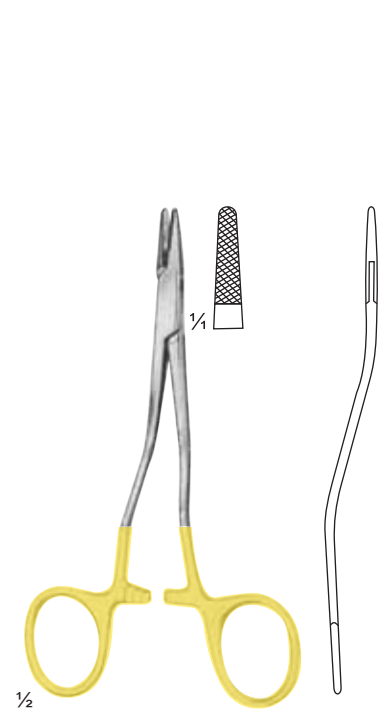

**Kilner**  
14-379-13 = 13.5 cm / 5 1/4"  
14-379-16 = 16.5 cm / 6 1/2"



**Baby-Crile-Wood**  
14-382-15  
15 cm / 6"



**Crile-Wood**  
14-385-15  
15 cm / 6"

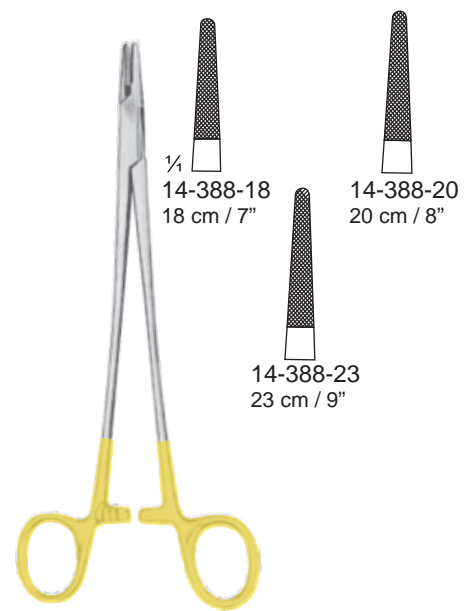

**Crile-Wood**  
14-388-18 - 14-388-23

**Needle Holders with Tungsten Carbide Inserts**

Nadelhalter mit Hartmetalleinsätzen

Porta-agujas con bocas de carburo de Tungsteno

Porte-aiguilles à mors en carbure de tungstène

Portaghi con placche di carburo di tungsteno

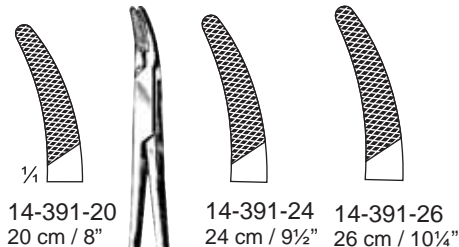
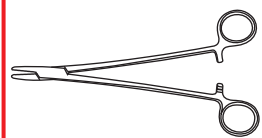

14-391-20  
20 cm / 8"

14-391-24  
24 cm / 9 1/2"

14-391-26  
26 cm / 10 1/4"

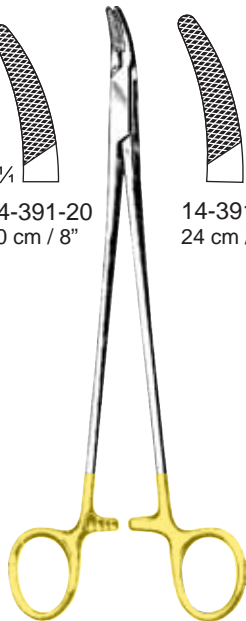

**Mayo-Hegar (Heaney)**  
14-391-20 - 14-391-26

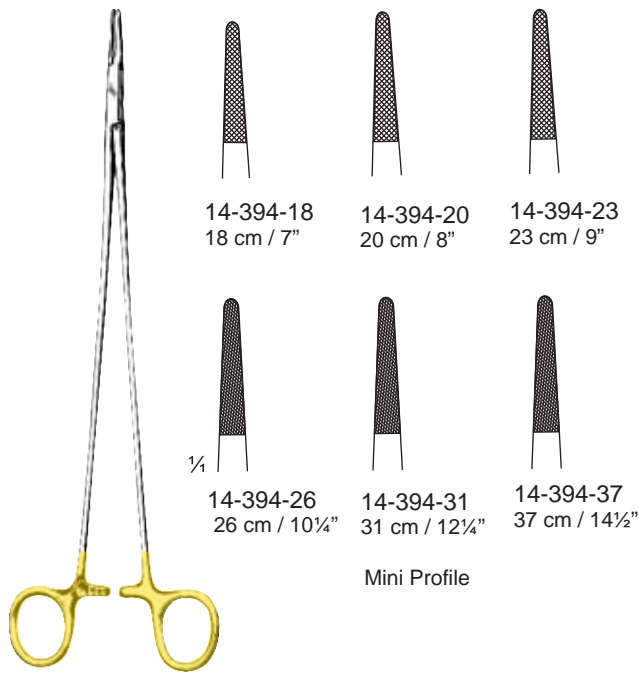

14-394-18  
18 cm / 7"

14-394-20  
20 cm / 8"

14-394-23  
23 cm / 9"

14-394-26  
26 cm / 10 1/4"

14-394-31  
31 cm / 12 1/4"

14-394-37  
37 cm / 14 1/2"

Mini Profile

**DeBakey**  
(Mayo-Hegar-Delicate)  
14-394-18 - 14-394-37

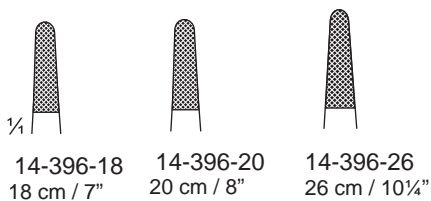
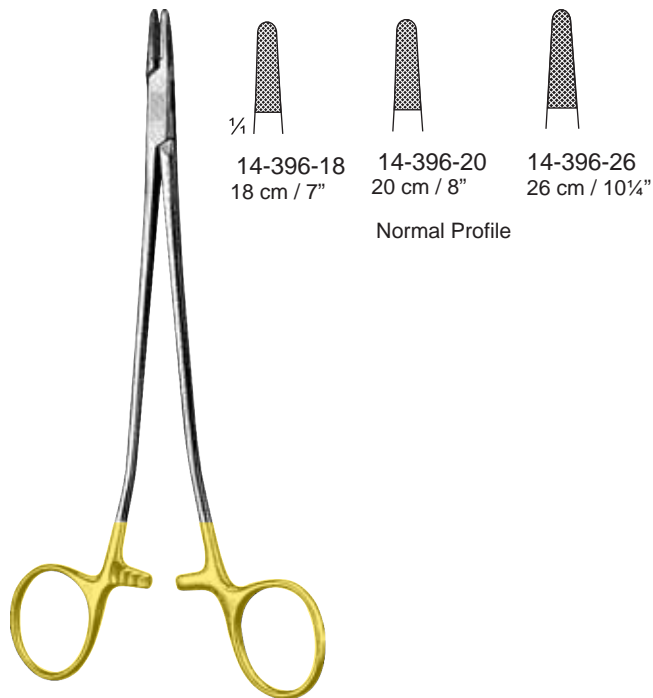

14-396-18  
18 cm / 7"

14-396-20  
20 cm / 8"

14-396-26  
26 cm / 10 1/4"

Normal Profile

**Sarot**  
14-396-18 - 14-396-26

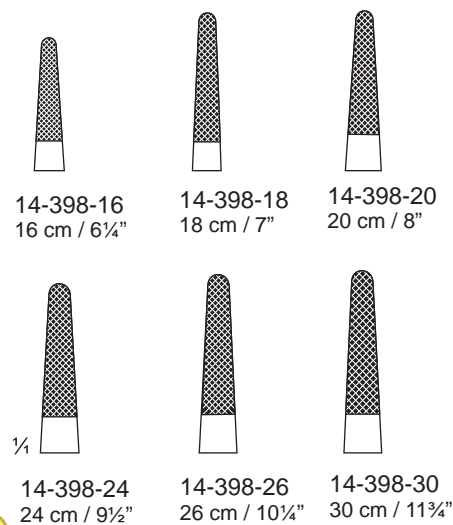
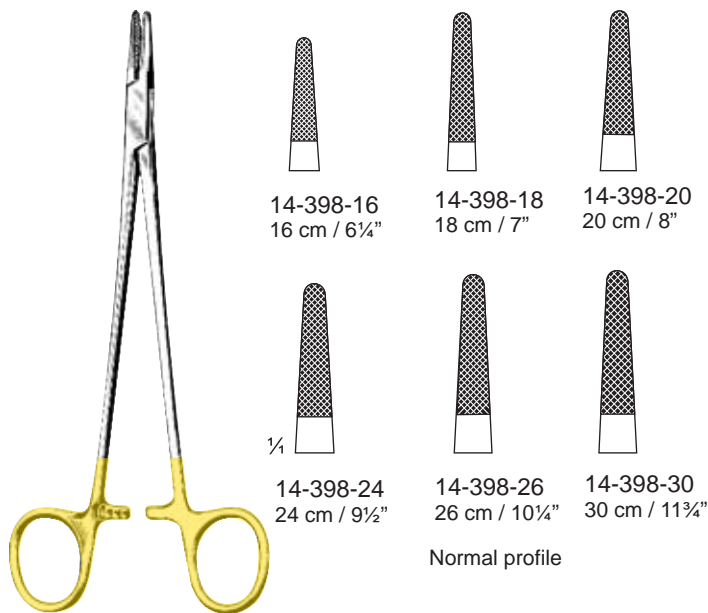

14-398-16  
16 cm / 6 1/4"

14-398-18  
18 cm / 7"

14-398-20  
20 cm / 8"

14-398-24  
24 cm / 9 1/2"

14-398-26  
26 cm / 10 1/4"

14-398-30  
30 cm / 11 1/4"

Normal profile

**Mayo-Hegar**  
14-398-16 - 14-398-30

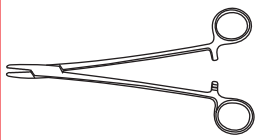

### Needle Holders with Tungsten Carbide Inserts

Nadelhalter mit Hartmetalleinsätzen  
Porta-agujas con bocas de carburo de Tungsteno

Porte-aiguilles à mors en carbure de tungstène  
Portaghi con placche di carburo di tungsteno

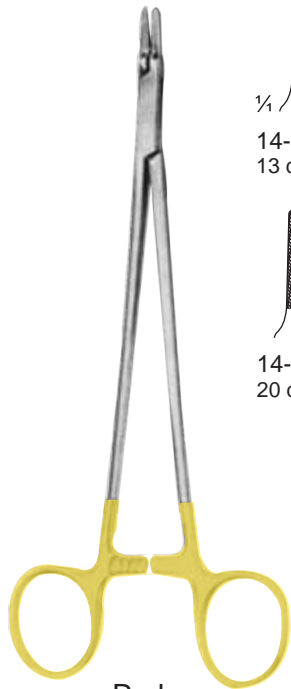

**Ryder**  
14-400-13 - 14-400-26

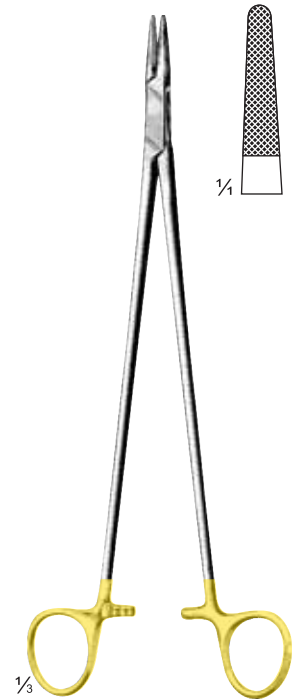
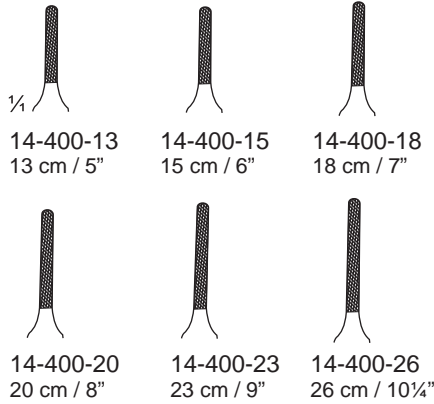

**Masson**  
14-402-27  
26.5 cm / 10 $\frac{1}{2}$ "

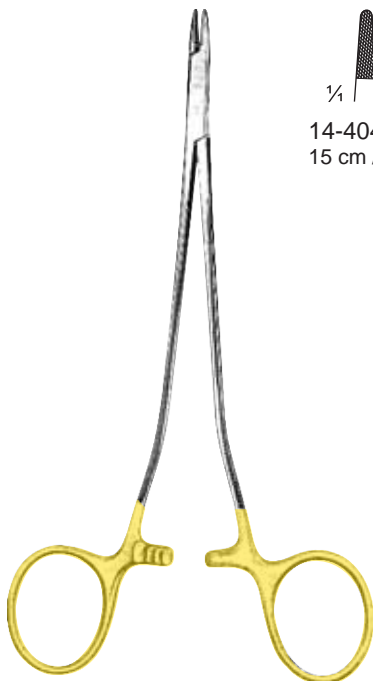

**Senning/Stille**  
14-404-15 - 14-404-20

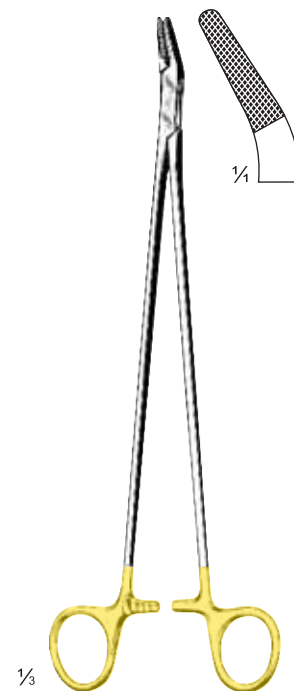
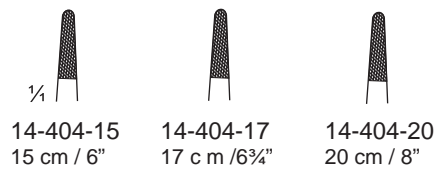

**Finocchietto**  
14-407-27  
26.5 cm / 10 $\frac{1}{2}$ "



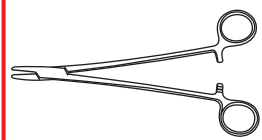

### Needle Holders with Tungsten Carbide Inserts

Nadelhalter mit Hartmetalleinsätzen  
Porta-agujas con bocas de carburo de Tungsteno

Porte-aiguilles à mors en carbure de tungstène  
Portaghi con placche di carburo di tungsteno



**Ryder-Vascular**  
14-412-13 - 14-412-26



14-412-13  
13 cm / 5"



14-412-15  
15 cm / 6"



14-412-18  
18 cm / 7"



14-412-20  
20 cm / 8"



14-412-23  
23 cm / 9"



14-412-26  
26 cm / 10¼"

Micro Profile

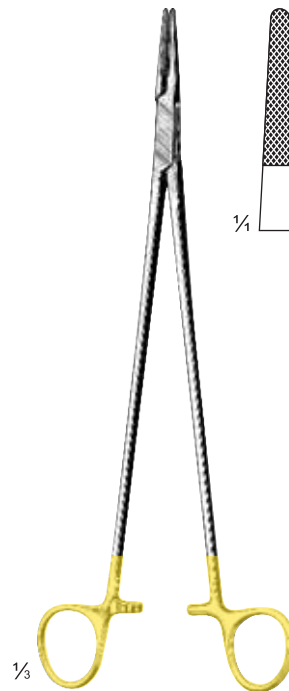

**Wangensteen**  
14-414-27  
27 cm / 10¾"

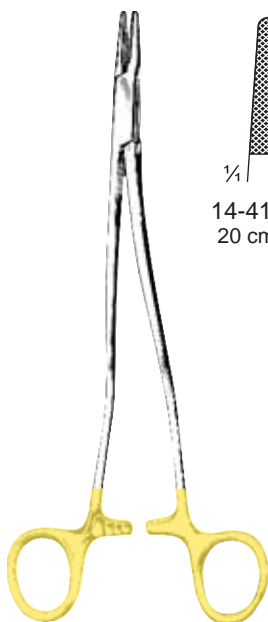

**Bozemann**  
14-417-20 - 14-417-26



14-417-20  
20 cm / 8"



14-417-24  
24 cm / 9½"



14-417-26  
26 cm / 10¼"



**New Orleans**  
14-420-18  
18 cm / 7"



**Needle Holders with Tungsten Carbide Inserts**

Nadelhalter mit Hartmetalleinsätzen

Porta-agujas con bocas de carburo de Tungsteno

Porte-aiguilles à mors en carbure de tungstène

Portaghi con placche di carburo di tungsteno

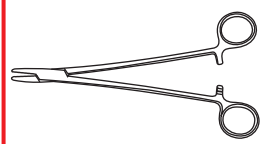

**Hegar-Vascular**  
14-426-14 - 14-426-23

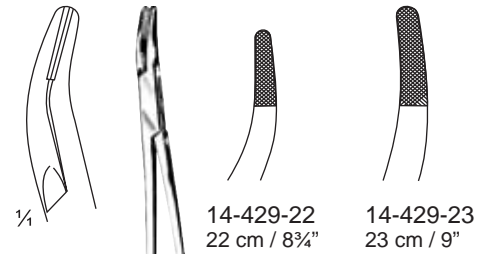
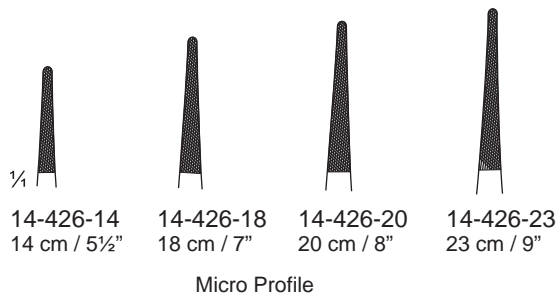

**Stratte**  
14-429-22 - 14-429-23



**Olsen-Hegar**  
14-432-14 - 14-432-18

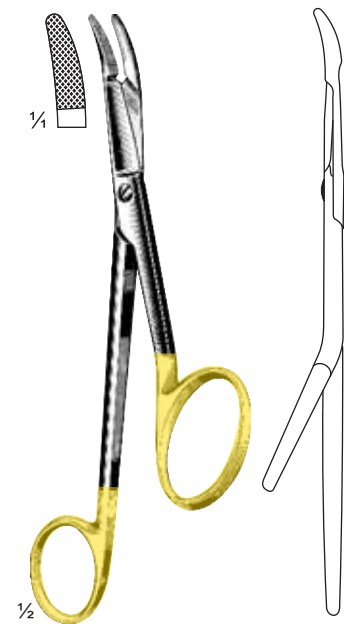
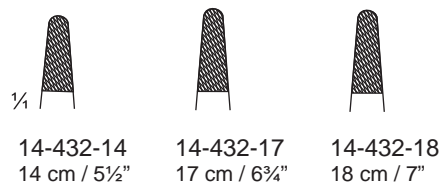

**Gillies**  
14-435-16  
16 cm / 6¼"

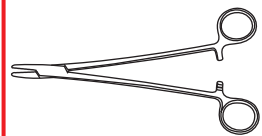

### Needle Holders with Tungsten Carbide Inserts

Nadelhalter mit Hartmetalleinsätzen  
Porta-agujas con bocas de carburo de Tungsteno

Porte-aiguilles à mors en carbure de tungstène  
Portaghi con placche di carburo di tungsteno

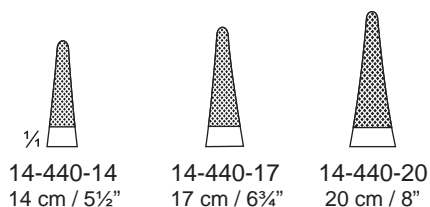

Mathieu-Kocher  
14-440-14 - 14-440-20

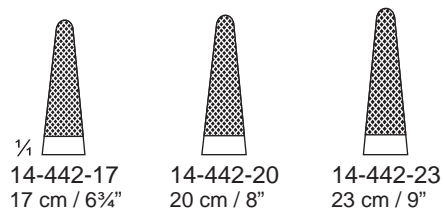

Mathieu  
14-442-17 - 14-442-23

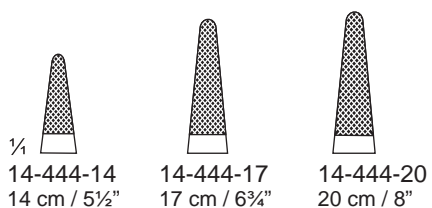
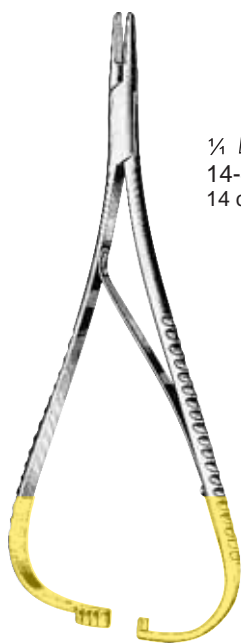

Mathieu  
14-444-14 - 14-444-20

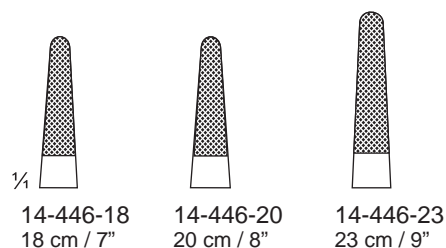

Langenbeck  
14-446-18 - 14-446-23

**Needle Holders with Tungsten Carbide Inserts**

Nadelhalter mit Hartmetalleinsätzen

Porta-agujas con bocas de carburo de Tungsteno

Porte-aiguilles à mors en carbure de tungstène

Portaghi con placche di carburo di tungsteno

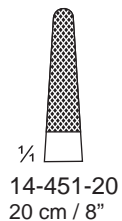
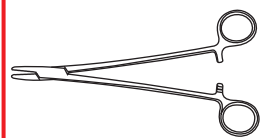

**Zweifel**  
14-451-20 - 14-451-23

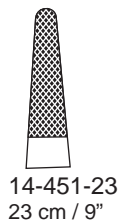

**Toennis**  
14-454-18  
18 cm / 7"

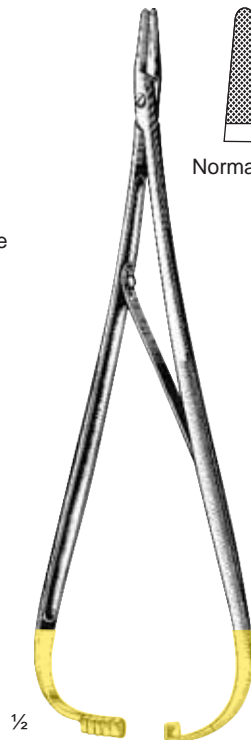
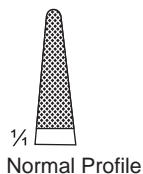

**Lichtenberg**  
14-456-20  
20 cm / 8"

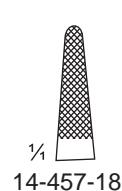
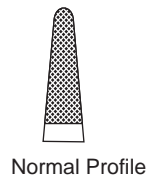

**Nauntun Morgan**  
14-457-18 = 18 cm / 7"  
14-457-25 = 25.5 cm / 10"

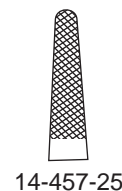

**Mathieu-Delicate**  
14-458-14 - 14-458-20

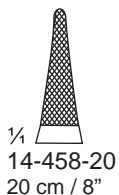

**Metzenbaum**  
14-461-17 - 14-461-19

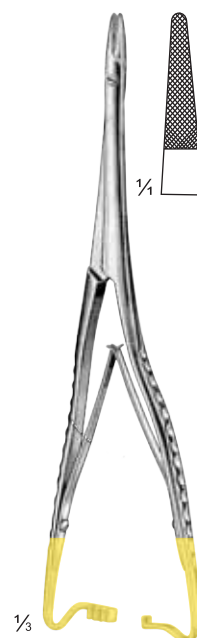
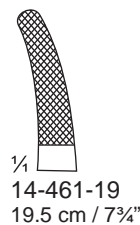
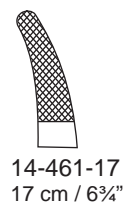

**Hosel**  
14-463-25  
25 cm / 9 3/4"



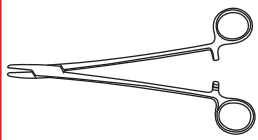

**Reverdin Needles**

Reverdin Nadeln  
Agujas de Reverdin

Aiguilles de Reverdin  
Aghi di Reverdin



1/2

Reverdin  
14-467-19 - 14-470-19  
19.5 cm / 7 3/4"

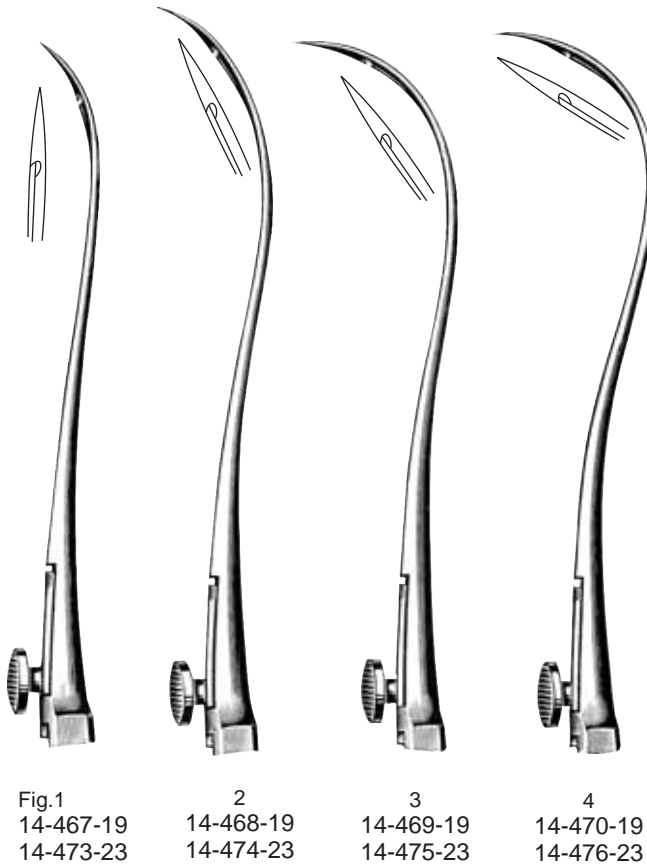

Fig.1	2	3	4
14-467-19	14-468-19	14-469-19	14-470-19
14-473-23	14-474-23	14-475-23	14-476-23



1/2

Reverdin  
14-473-23 - 14-476-23  
22.5 cm / 8 3/4"



1/2

Reverdin  
14-479-14 - 14-482-14  
(Fig. 1-4) 14 cm / 5 1/2"

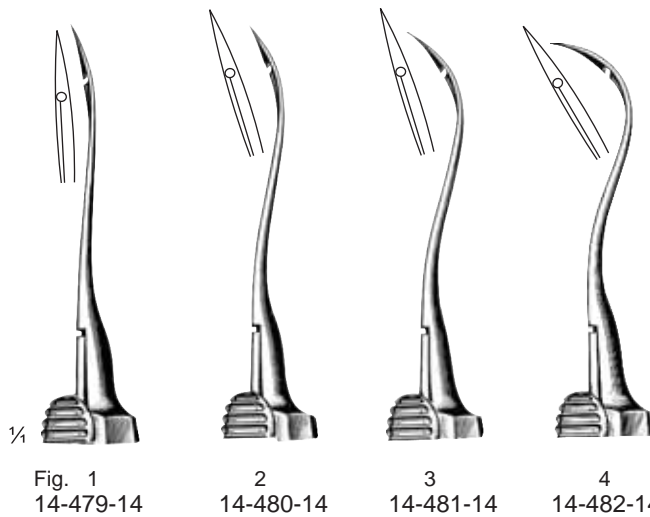
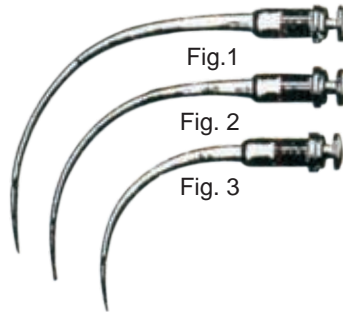
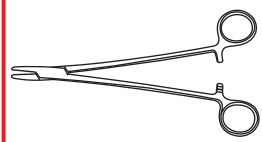

Fig. 1	2	3	4
14-479-14	14-480-14	14-481-14	14-482-14

**Needle Holders, Ligature Needles**

Nadelhalter, Unterbindungsnadeln  
Porta-agujas, Agujas para ligaduras

Porte-aiguilles, Aiguilles à ligatures  
Portaghi, Aghi per legatura



14-491-01 Sharp Needles

14-491-02 Sharp Needles

14-491-03 Sharp Needles

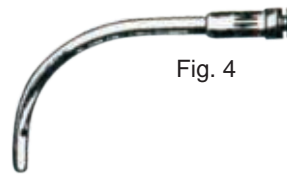

14-491-04 Blunt needles



**Young-Hryntschak**  
14-487-25  
25 cm / 9¾"



14-488-01



14-488-02



14-488-03



**Young-Millin**  
14-489-20  
20 cm / 8"  
with 1 needle



**Victor-Bonney**  
14-490-21  
(handle only)  
21 cm / 8¼"



**Millin**  
14-492-24  
Ligature holding forceps  
24.5 cm / 9¾"

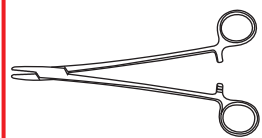

**Ligature Needles**

Unterbindungsnadeln  
Agujas para ligaduras

Aiguilles à ligatures  
Aghi per legatura



Right  
14-493-15  
15 cm / 6"

Duyuptren  
14-495-15  
(Left)  
15 cm / 6"

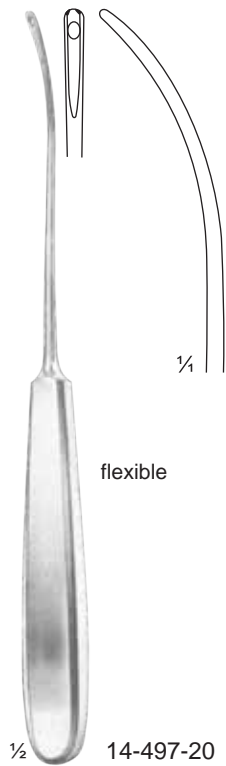

flexible

14-497-20  
20 cm / 8"

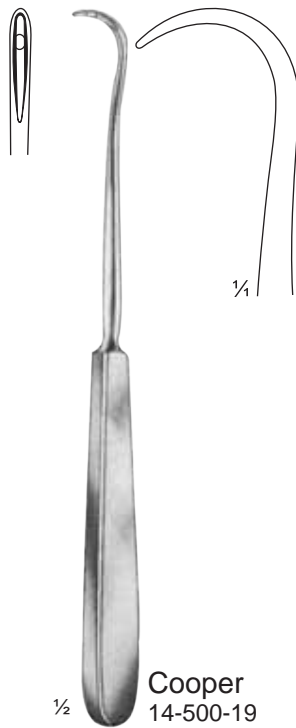

Cooper  
14-500-19  
19 cm / 7½"



Jolls-Kocher  
14-502-01 - 14-502-03  
19 cm / 7½"



14-505-15  
15 cm / 6"



Syme  
14-507-17  
17 cm / 6¾"



Jonesco  
14-509-18  
Needle for wire suture  
18.5 cm / 7¼"



Emmet  
14-511-01 = 19 cm / 7½"  
14-511-02 = 19 cm / 7½"  
14-511-03 = 19 cm / 7½"

**Ligature Needles**

Unterbindungsnadeln  
Agujas para ligaduras

Aiguilles à ligatures  
Aghi per legatura

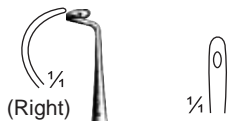
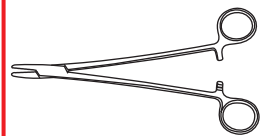

**Kronecker**  
14-515-13  
13 cm / 5"

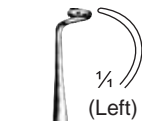

**Kronecker**  
14-517-13  
13 cm / 5"

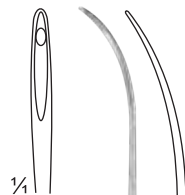

flexible

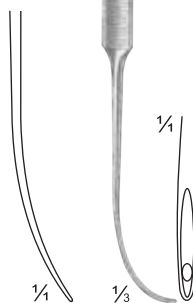

**Schmieden-Dick**  
14-519-32  
32 cm / 12 1/2"

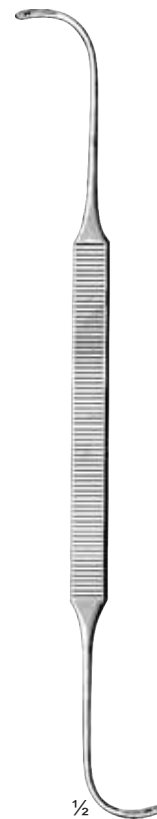

**Schmieden**  
14-521-21  
21 cm / 8 1/4"



**Brunner**  
14-523-25  
25.5 cm / 10"



**Trelat**  
14-526-23  
23 cm / 9"



**Claus**  
14-529-23  
23 cm / 9"



**(Straight)**  
14-531-01  
13 cm / 5"



**(Right)**  
14-534-01  
13 cm / 5"



**(Left)**  
14-534-02  
13 cm / 5"



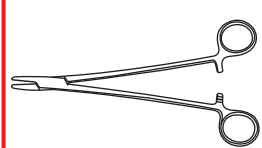

**Ligature Needles**

Unterbindungsnadeln  
Agujas para ligaduras

Aiguilles à ligatures  
Aghi per legatura



Deschamps

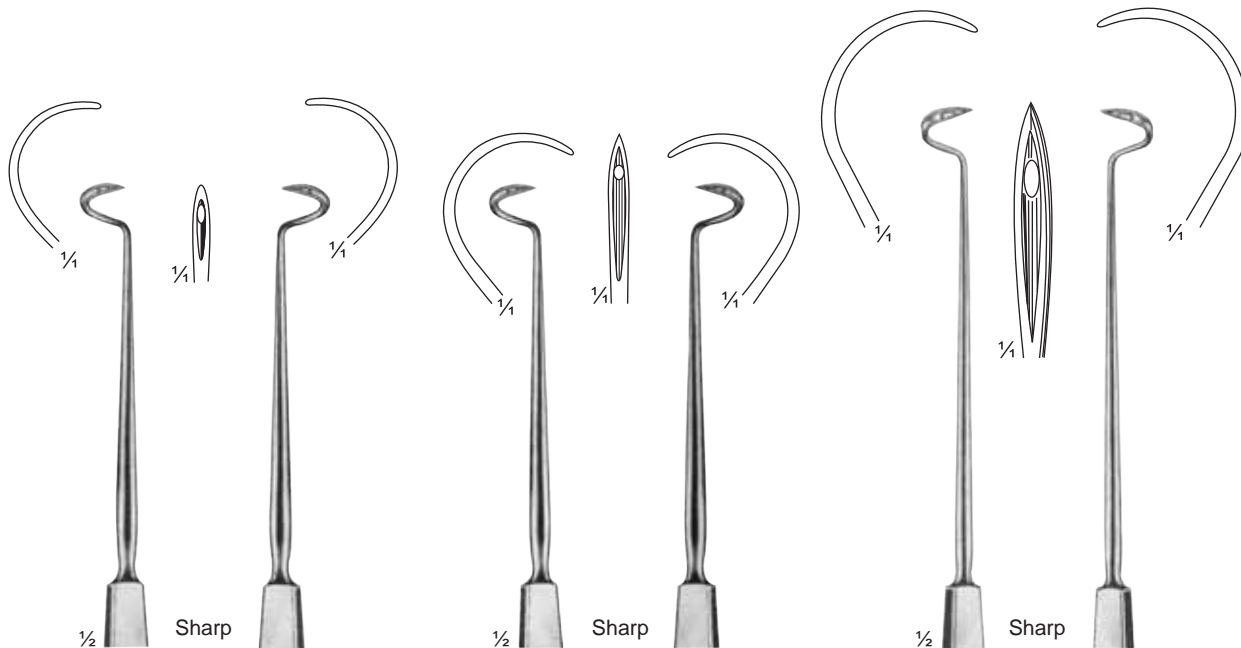

	Right	Left	Right	Left	Right	Left
20 cm / 8"	14-541-20	14-542-20	14-545-20	14-546-20	14-549-21	14-550-21
21 cm / 8¼"					14-549-21	14-550-21
27 cm / 10¾"					14-553-27	14-554-27

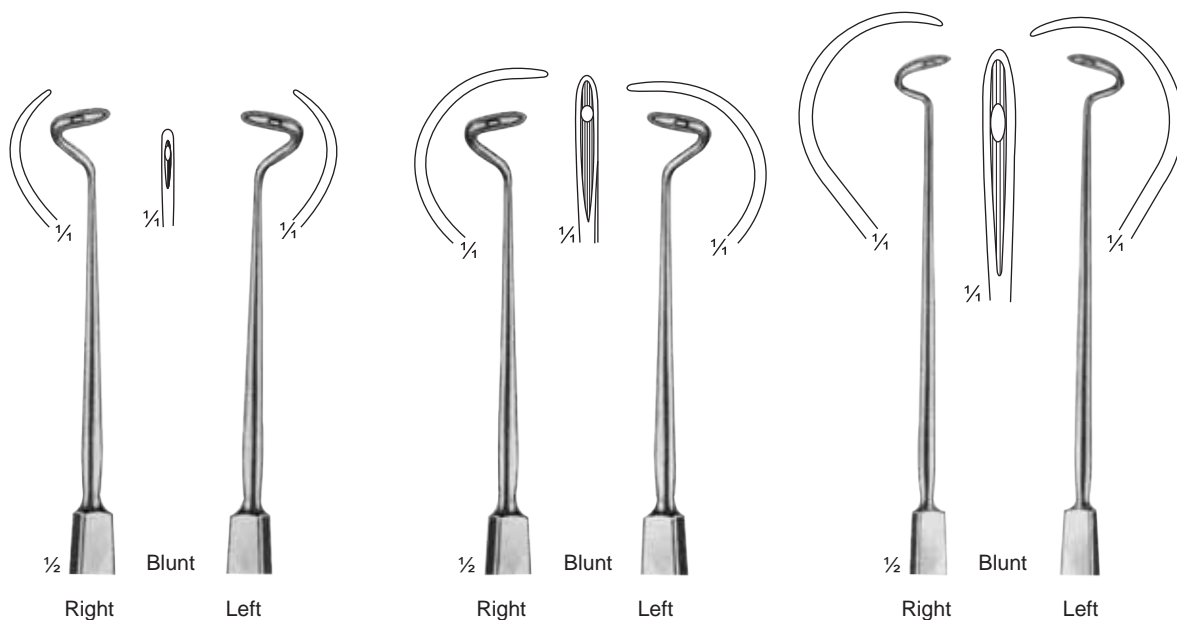

	Right	Left	Right	Left	Right	Left
20 cm / 8"	14-557-20	14-558-20	14-561-20	14-562-20	14-565-21	14-566-21
21 cm / 8¼"					14-565-21	14-566-21
27 cm / 10¾"					14-569-27	14-570-27

**Ligature Needles, Ligature Conductors**

Unterbindungsadeln, Führungshohlsonden  
 Agujas para ligaduras, Sondas conductoras

Aiguilles à ligatures, Sondes conductrices  
 Aghi per legatura, Sonde conduttrici

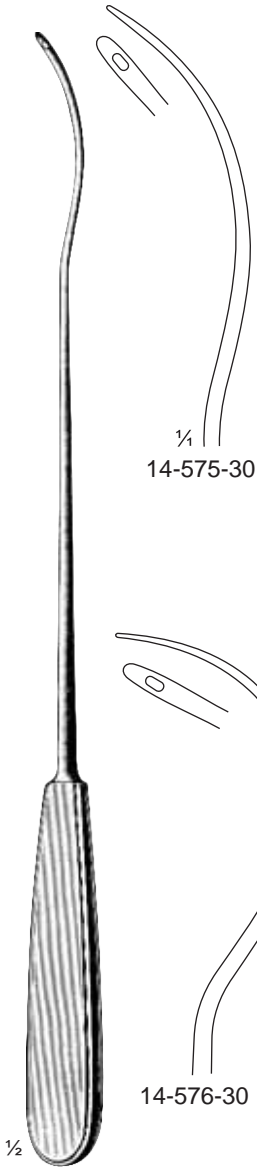
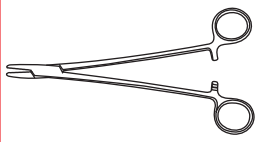

$\frac{1}{4}$   
 14-575-30

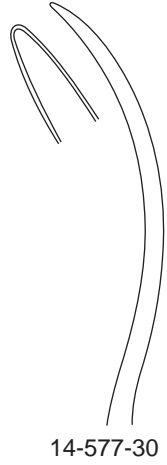

14-577-30

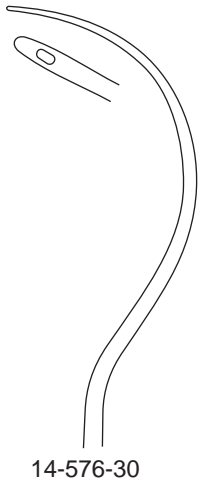

14-576-30

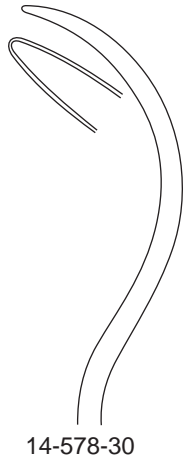

14-578-30

$\frac{1}{2}$

**Brunner**  
 14-575-30 - 14-578-30  
 30 cm / 11 $\frac{3}{4}$ "



$\frac{1}{2}$

**Kirschner**  
 14-581-25  
 25.5 cm / 10"



$\frac{1}{4}$



$\frac{1}{4}$

$\frac{1}{2}$

**Kirschner**  
 14-584-28  
 28 cm / 11"

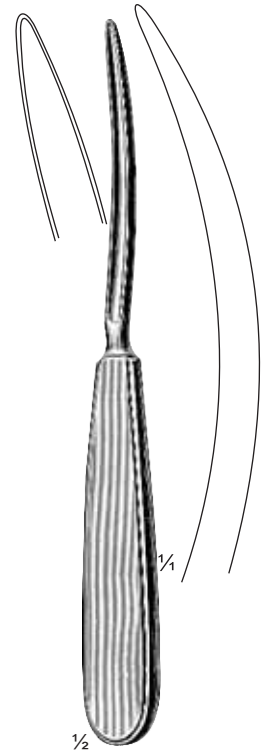

$\frac{1}{4}$

$\frac{1}{2}$

14-587-19  
 19 cm / 7 $\frac{1}{2}$ "

**Ligature Conductors**

Führungshohlsonden  
Sondas conductoras

Sondes conductrices  
Sonde conduttrici

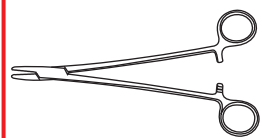

1/2

**Brunner**

14-590-01 - 14-590-04  
30 cm / 11 3/4"

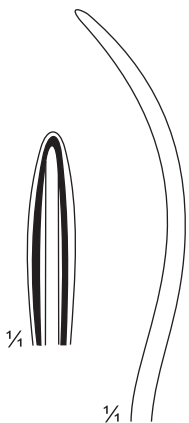

1/4

1/4

14-590-01



1/4

14-590-03  
Right



1/4

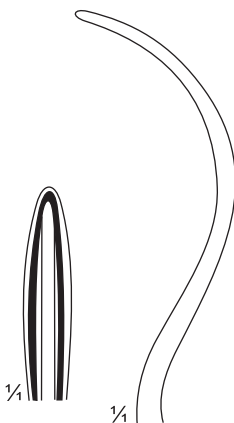

1/4

1/4

14-590-02



1/4

14-590-04  
Left



**Kocher**

15 cm / 6"  
16 cm / 6 1/4"  
18 cm / 7"



1/4

14-593-15  
14-593-16



1/4

14-594-15  
14-594-16

with hole



1/4

14-595-18  
with hole

1/2

**Brunner**  
14-591-25  
25 cm / 9 3/4"

**Ligature Conductors**

Führungshohlsonden  
Sondas conductoras

Sondes conductrices  
Sonde conduttrici

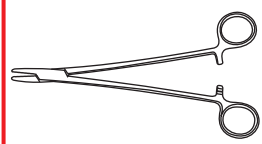

**Burnner-Ferrozell**  
14-602-18 = 18 cm / 7"  
14-602-27 = 27 cm / 10¾"



**Kirschner-Ferrozell**  
14-605-27  
27 cm / 10¾"



14-608-01  
curved

14-608-02  
straight

**Ferrozell**  
14-608-01 - 14-608-02  
19 cm / 7½"



**Ferrozell**  
14-610-24  
24 cm / 9½"

½

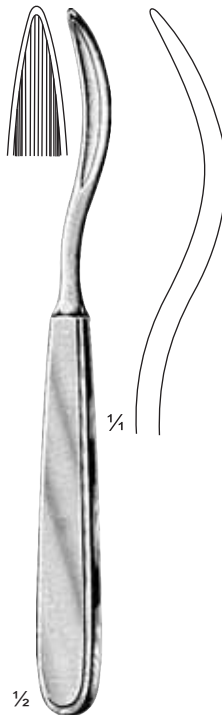

**Schmieden**  
14-613-19  
19 cm / 7½"

½

¼

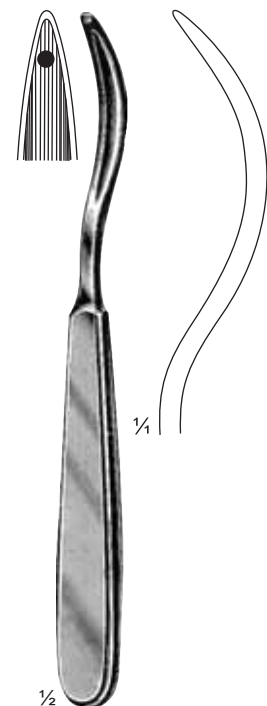

**Schmieden- Payr**  
14-616-19  
19 cm / 7½"  
with hole

½

¼

**Ligature Conductors**

Führungshohlsonden  
Sondas conductoras

Sondes conductrices  
Sonde conduttrici

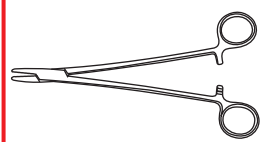

**König**  
14-618-03 - 14-618-07

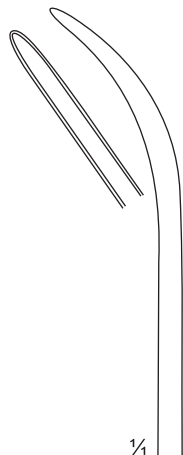

1/4  
14-618-03  
19.5 cm / 7 3/4"

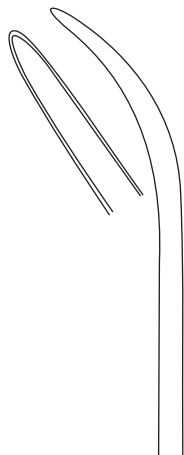

14-618-05  
19.5 cm / 7 3/4"

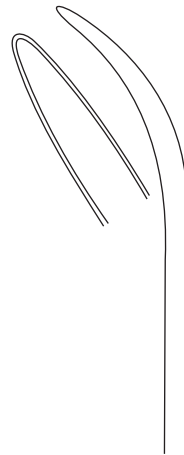

14-618-07  
19.5 cm / 7 3/4"

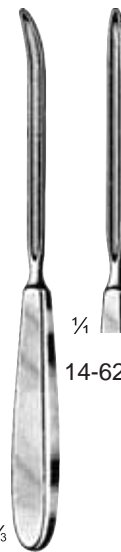

1/8  
14-624-22  
**payr**  
14-623-22 - 14-624-22  
22 cm / 8 3/4"

Knot Tier  
Schlingendreher  
Tuerce-Lazos  
Tords-fil  
Torcifilo



**Negus**  
14-635-23  
23 cm / 9"  
(Knot Tier)



1/2  
**Fawcett**  
14-638-23  
23 cm / 9"  
Ligature adjuster

Ligature Adjuster  
Fadengabel  
Horquilla de hilos  
Pousse-fil  
Forchetta de sutura



1/2  
**Caspar**  
14-641-23  
23 cm / 9"  
Ligature adjuster

Ligature Catcher  
Fadenfänger  
Captador de hilos  
Porte-ligature  
Portalegature



**Friedrich**  
14-627-16  
16 cm / 6 1/4"  
Ligature Catcher



1/3  
**Mod. Wien**  
14-630-23  
23.5 cm / 9 1/4"  
Ligature Catcher



1/3  
**Bozemann**  
14-632-21  
21 cm / 8 1/4"  
(Knot Tier)

**Clip Applying Forceps**

Wundklammerpinzetten, Wundklammerzängchen

Pinces à poser les agrafes

Pinzas aplicadoras para agrafes

Pinze per applicare le agrafe

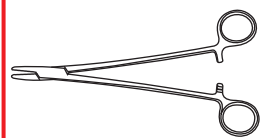

1/2

**Hegenbarth**  
14-646-12  
12.5 cm / 5"



1/2

**Wachenfeldt**  
14-648-12  
12.5 cm / 5"



1/2

**Michel**  
14-650-12  
12 cm / 4 3/4"

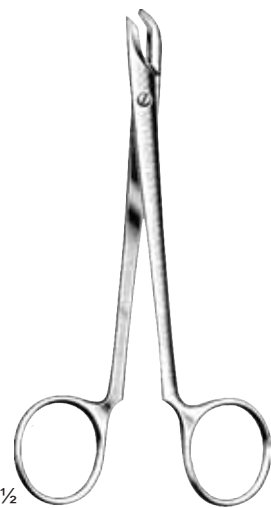

1/2

**Collin**  
14-652-13  
13 cm / 5"



1/2

**Richter-Heath**  
14-655-14  
14 cm / 5 1/2"



**Braithwaite**  
14-657-16  
16.5 cm / 6 1/2"



1/2

**Ochsner**  
14-660-14  
14 cm / 5 1/2"

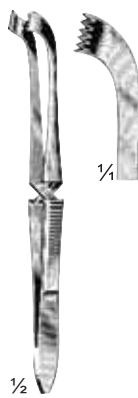

1/2

**Lange**  
14-663-10  
10 cm / 4"



1/2

**Wachenfeldt**  
14-666-12  
12 cm / 4 3/4"



**Childe**  
14-668-18  
18 cm / 7"



1/2

**Childe**  
14-670-18  
18 cm / 7"



**Bonney**  
14-673-15  
15 cm / 6"

**Clip Applying Forceps**

Wundklammerpinzetten, Wundklammerzängchen

Pinces à poser les agrafes

Pinzas aplicadoras para agrafes

Pinze per applicare le agrafe

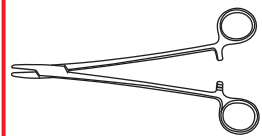

**Michel**  
14-676-12  
12 cm / 4¾"



**Michel**  
14-678-12  
12 cm / 4¾"



**Wachenfeldt**  
14-680-12  
12.5 cm / 5"

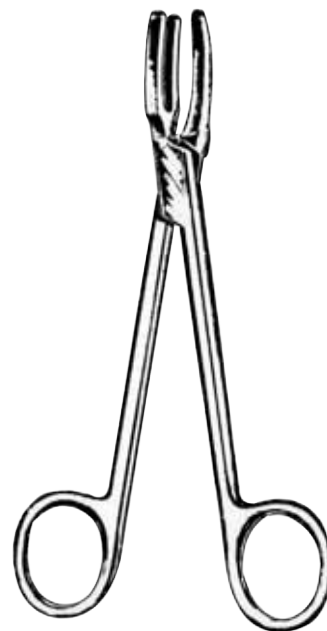

**Denis Browne**  
14-682-16  
16 cm / 6¼"  
(Tube Breaker)



**Guy Galabin**  
(Suture Holder)  
14-684-15  
15 cm / 6"



**Denis Browne**  
(Needle Catcher)  
14-687-16  
16 cm / 6¼"

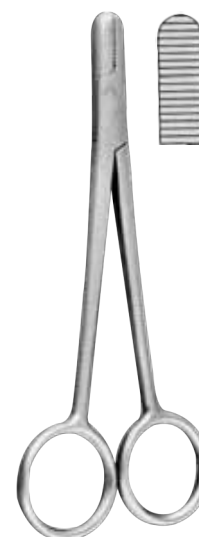

**Denis Browne**  
(Collar Crushing)  
14-689-14  
14.5 cm / 5¾"

**Surgical Needles, Intestinal Needles**

Chirurgische Nadeln, Darmnadeln  
Agujas quirúrgicas, Aguja intestinal

Aiguilles Chirurgicales, Aiguilles intestinales  
Aghi Chirurgici, Aghi intestinali

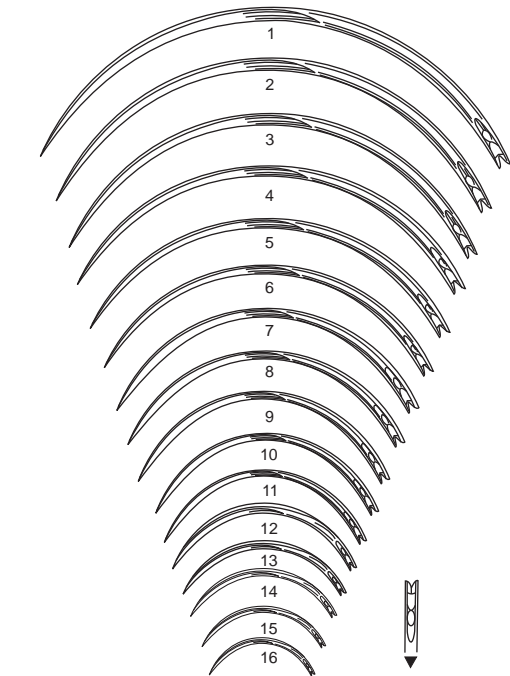

- |           |        |
|-----------|--------|
| 14-695-01 | Fig. 1 |
| 14-695-02 | 2      |
| 14-695-03 | 3      |
| 14-695-04 | 4      |
| 14-695-05 | 5      |
| 14-695-06 | 6      |
| 14-695-07 | 7      |
| 14-695-08 | 8      |
| 14-695-09 | 9      |
| 14-695-10 | 10     |
| 14-695-11 | 11     |
| 14-695-12 | 12     |
| 14-695-13 | 13     |
| 14-695-14 | 14     |
| 14-695-15 | 15     |
| 14-695-16 | 16     |

curved 3/8 circle

unit for sale 1 dozen

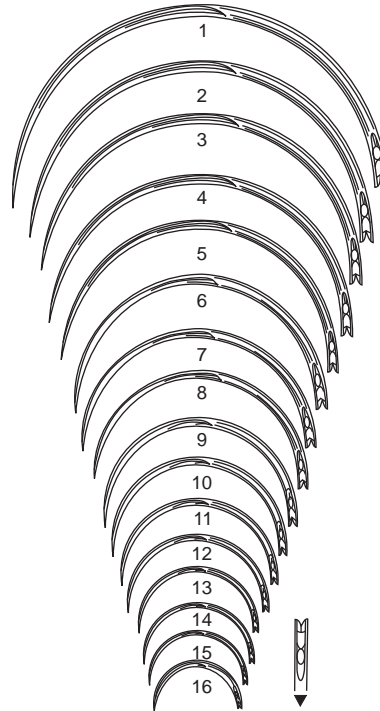

- |           |        |
|-----------|--------|
| 14-697-01 | Fig. 1 |
| 14-697-02 | 2      |
| 14-697-03 | 3      |
| 14-697-04 | 4      |
| 14-697-05 | 5      |
| 14-697-06 | 6      |
| 14-697-07 | 7      |
| 14-697-08 | 8      |
| 14-697-09 | 9      |
| 14-697-10 | 10     |
| 14-697-11 | 11     |
| 14-697-12 | 12     |
| 14-697-13 | 13     |
| 14-697-14 | 14     |
| 14-697-15 | 15     |
| 14-697-16 | 16     |

curved 1/2 circle

unit for sale 1 dozen

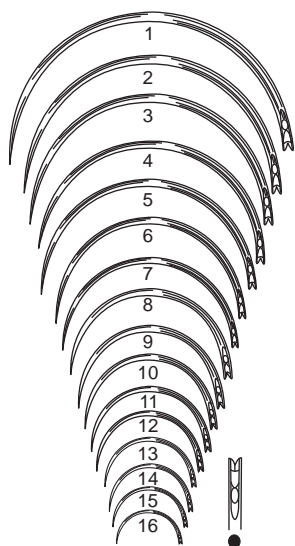

- |           |        |
|-----------|--------|
| 14-699-01 | Fig. 1 |
| 14-699-02 | 2      |
| 14-699-03 | 3      |
| 14-699-04 | 4      |
| 14-699-05 | 5      |
| 14-699-06 | 6      |
| 14-699-07 | 7      |
| 14-699-08 | 8      |
| 14-699-09 | 9      |
| 14-699-10 | 10     |
| 14-699-11 | 11     |
| 14-699-12 | 12     |
| 14-699-13 | 13     |
| 14-699-14 | 14     |
| 14-699-15 | 15     |
| 14-699-16 | 16     |

curved 1/2 circle

unit for sale 1 dozen

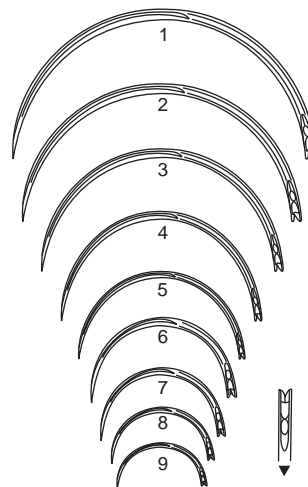

- |           |        |
|-----------|--------|
| 14-701-01 | Fig. 1 |
| 14-701-02 | 2      |
| 14-701-03 | 3      |
| 14-701-04 | 4      |
| 14-701-05 | 5      |
| 14-701-06 | 6      |
| 14-701-07 | 7      |
| 14-701-08 | 8      |
| 14-701-09 | 9      |

curved 1/2 circle

unit for sale 1 dozen



**Surgical Needles, Intestinal Needles**

Chirurgische Nadeln, Darmnadeln  
 Agujas quirúrgicas, Agujas intestinales

Aiguilles Chirurgicales, Aiguilles intestinales  
 Aghi Chirurgici, Aghi intestinali

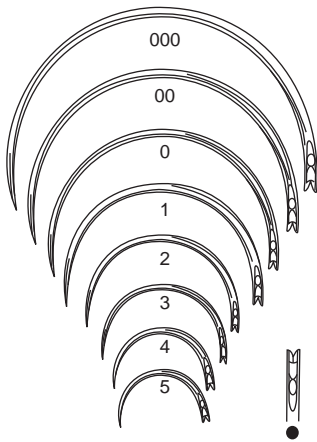
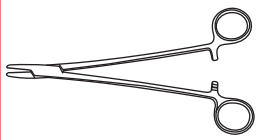
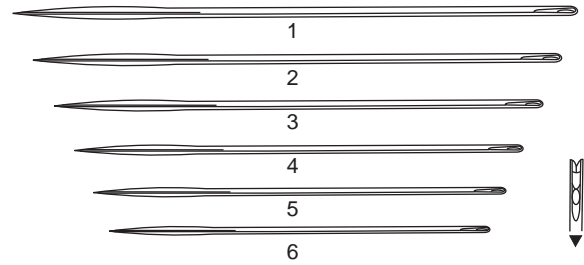

	Fig.
14-705-10	0
14-705-20	00
14-705-30	000
14-705-01	1
14-705-02	2
14-705-03	3
14-705-04	4
14-705-05	5

curved 1/2 circle      unit for sale 1 dozen



**Keith**  
 unit for sale 1 dozen

	Fig.
14-707-01	1
14-707-02	2
14-707-03	3
14-707-04	4
14-707-05	5
14-707-06	6

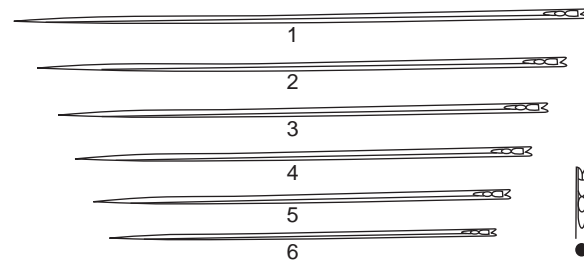

**Keith**  
 unit for sale 1 dozen

	Fig.
14-709-01	1
14-709-02	2
14-709-03	3
14-709-04	4
14-709-05	5
14-709-06	6

**Surgical Needles, Intestinal Needles**

Chirurgische Nadeln, Darmnadeln  
 Agujas quirúrgicas, Agujas intestinales

Aiguilles Chirurgicales, Aiguilles intestinales  
 Aghi Chirurgici, Aghi intestinali

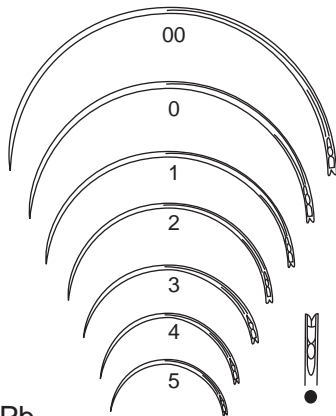
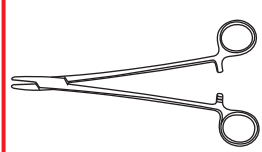

Pb

curved, 1/2 circle, SU = 12/Pack

- |           |      |
|-----------|------|
|           | Fig. |
| 14-715-10 | 0    |
| 14-715-20 | 00   |
| 14-715-01 | 1    |
| 14-715-02 | 2    |
| 14-715-03 | 3    |
| 14-715-04 | 4    |
| 14-715-05 | 5    |

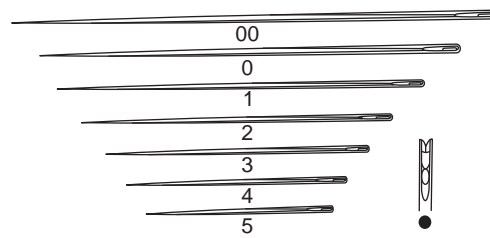

SU = 12/Pack

- |           |      |
|-----------|------|
|           | Fig. |
| 14-717-10 | 0    |
| 14-717-20 | 00   |
| 14-717-01 | 1    |
| 14-717-02 | 2    |
| 14-717-03 | 3    |
| 14-717-04 | 4    |
| 14-717-05 | 5    |

**Intestinal Needle**

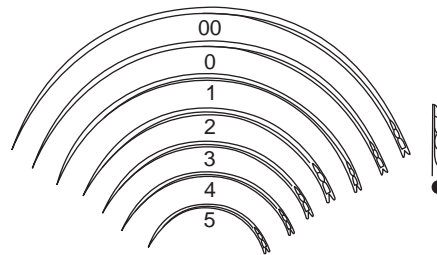

curved, 3/8 circle, SU = 12/Pack

- |           |      |
|-----------|------|
|           | Fig. |
| 14-719-10 | 0    |
| 14-719-20 | 00   |
| 14-719-01 | 1    |
| 14-719-02 | 2    |
| 14-719-03 | 3    |
| 14-719-04 | 4    |
| 14-719-05 | 5    |

**Eye Needles, Vascular Needles**

Augennadlen, Gefäßnadeln  
Agujas oculares, Aguja vasculares

Aiguilles ophtalmiques, Aiguilles vasculaires  
Aghi oftalmichi, Aghi vascolari

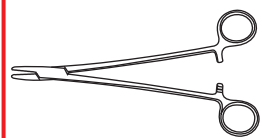

Eye Needles

Vascular Needles

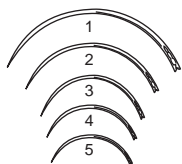

	Fig.
14-727-01	1
14-727-02	2
14-727-03	3
14-727-04	4
14-727-05	5

curved 3/8 circle

Unit for sale 1 dozen

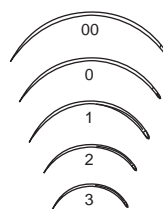

	Fig.
14-729-01	1
14-729-02	2
14-729-03	3
14-729-04	4
14-729-05	5

curved 3/8 circle

Unit for sale 1 dozen

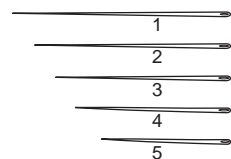

	Fig.
14-731-01	1
14-731-02	2
14-731-03	3
14-731-04	4
14-731-05	5

Unit for sale 1 dozen

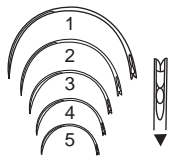

	Fig.
14-733-01	1
14-733-02	2
14-733-03	3
14-733-04	4
14-733-05	5

curved 1/2 circle

Unit for sale 1 dozen

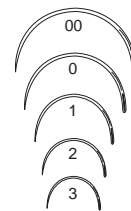

	Fig.
14-735-01	1
14-735-02	2
14-735-03	3
14-735-04	4
14-735-05	5

curved 3/8 circle

Unit for sale 1 dozen

