

**Gynecology / Ginekologia**

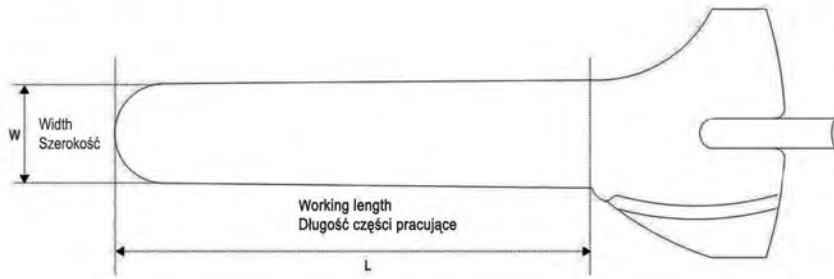

Vaginal specula  
Wzierniki pochwowe



Autoclavable  
Możliwość sterylizacji w autoklawie

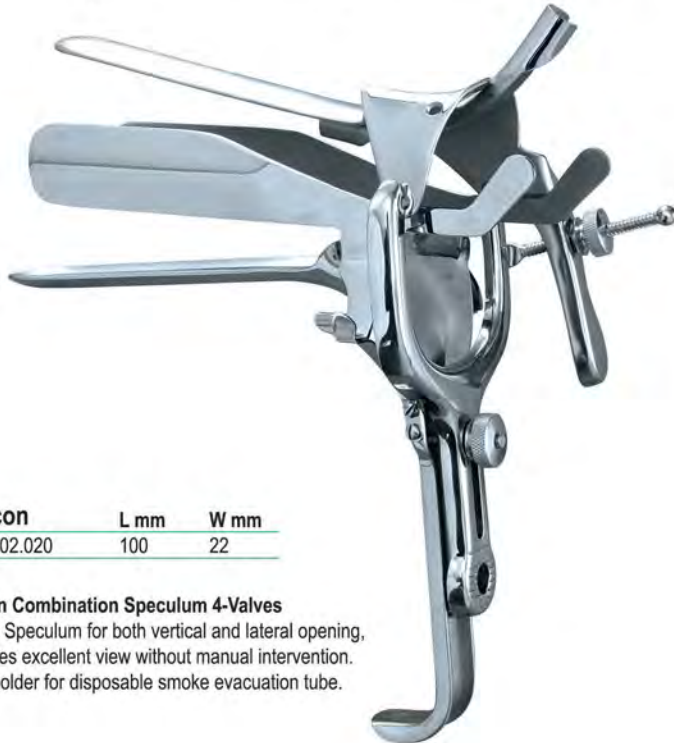

Falcon	L mm	W mm
GN.002.020	100	22

**Falcon Combination Speculum 4-Valves**

Single Speculum for both vertical and lateral opening, provides excellent view without manual intervention. With holder for disposable smoke evacuation tube.



Collin-Virgin	L mm	W mm
GN.006.010	65	22
For virgins		



Collin	L mm	W mm
GN.007.010	85	30
GN.007.030	100	35
GN.007.040	110	40



Collin-Virgin	L mm	W mm
GN.015.010	75	17
For virgins		



**Vaginal specula**  
**Wzierniki pochwowe**



Autoclavable  
Możliwość sterylizacji w autoklawie



Central fixation screw  
Śruba centralnie

Cusco-Virgin	L mm	W mm
GN.014.010	75	17

For virgins / Dla dziewczyc

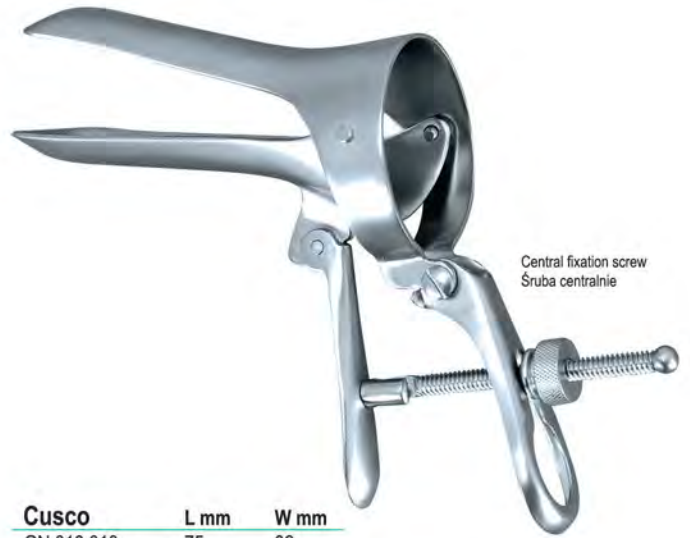

Central fixation screw  
Śruba centralnie

Cusco	L mm	W mm
GN.018.010	75	32
GN.018.020	85	35
GN.018.030	100	35



Lateral fixations screw  
Śruba z boku

Cusco	L mm	W mm
GN.019.010	75	32
GN.019.020	85	35
GN.019.030	100	35



Lateral fixations screw  
Śruba z boku

Cusco-Swiss	L mm	W mm
GN.020.010	80	22
GN.020.020	100	25
GN.020.030	105	27



George combined Cusco+Sims	L mm	W mm
GN.142.030	95	35

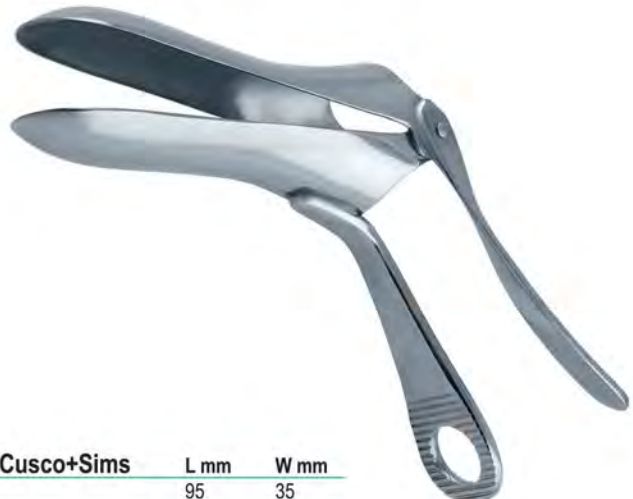



Vaginal specula  
Wzierniki pochwowe



Autoclavable  
Możliwość sterylizacji w autoklawie



Guttmann	L mm	W mm
GN.092.010	95	35



Grave standard

Grave	L mm	W mm
GN.050.010	75	20
GN.050.020	95	35
GN.050.030	115	35



Pederson	L mm	W mm
GN.038.010	75	13
GN.038.020	100	22
GN.038.030	110	25



Grave Maxi-View

Grave Maxi-View	L mm	W mm
GN.042.020	95	35
GN.042.030	115	35



**Vaginal Specula and retractors**  
**Wzierniki pochwowe i Haki**



Autoclavable  
Możliwość sterylizacji w autoklawie



Set (Speculum + Retractor)  
Zestaw (Wziernik + Hak)

Set (Speculum + Retractor)  
Zestaw (Wziernik + Hak)



Grave Wide-View	L mm	W mm
GN.046.020	95	35
GN.046.030	115	35

**XXL**

Grave Wide-View	L mm	W mm
GN.046.040	150	35

For obese patients

**Kristeller-Standard**

Fig.0	GN.160.000	GN.160.001 + GN.160.002
Fig.1	GN.160.010	GN.160.011 + GN.160.012
Fig.2	GN.160.020	GN.160.021 + GN.160.022
Fig.3	GN.160.030	GN.160.031 + GN.160.032
	175mm	



Speculum only  
Wziernik



Retractor only  
Hak



**GN.148.000**  
Set of 3  
Zestaw 3 sztuk

Kristeller-Standard	L mm	W mm
GN.160.001	70	15
GN.160.011	70	27
GN.160.021	75	30
GN.160.031	90	36
	175mm	

Kristeller-Standard	L mm	W mm
GN.160.002	75	10
GN.160.012	75	23
GN.160.022	80	26
GN.160.032	100	32
	175mm	

Sims	L mm	W mm
GN.148.010	65 / 70	25 / 30
GN.148.020	70 / 70	30 / 35
GN.148.030	85 / 90	35 / 40



**Vaginal specula and retractors**  
**Wzierniki pochwowe i Haki**



Autoclavable  
Możliwość sterylizacji w autoklawie



Set (Speculum + Retractor)  
Zestaw (Wziernik + Hak)



Speculum  
Wziernik



Retractor  
Hak

**Kallmorgen**

Fig.1	GN.170.010	GN.170.011 + GN.170.012
Fig.2	GN.170.020	GN.170.021 + GN.170.022
	200mm	

**Kallmorgen**

	L mm	W mm
GN.170.011	70	40
GN.170.021	90	40
	200mm	

**Kallmorgen**

	L mm	W mm
GN.170.012	70	33
GN.170.022	90	33
	200mm	



Speculum  
Wziernik



Retractor  
Hak



**Braun**

	L mm	W mm
GN.190.001	56	13
	180mm	

**Braun**

	L mm	W mm
GN.190.002	60	10
	180mm	

**Jackson**

	L mm	W mm
GN.176.010	75	35
GN.176.020	90	35
GN.176.030	100	35
	175mm	



**Vaginal Specula and retractors**  
**Wzierniki pochwowe i Haki**



Autoclavable  
Możliwość sterylizacji w autoklawie



Speculum only  
Wziernik

<b>Mathieu</b>	<b>L mm</b>	<b>W mm</b>
GN.194.021	95	30
210mm		



Retractor only  
Hak

<b>Mathieu</b>	<b>L mm</b>	<b>W mm</b>
GN.194.022	100	26
210mm		



<b>Auvard</b>	<b>L mm</b>	<b>W mm</b>
GN.107.010	80	38
GN.107.020	90	45
225mm		
Weight / Waga = 1.15kg		



<b>Doyen</b>	<b>L mm</b>	<b>W mm</b>
GN.213.010	55	45
GN.213.020	85	45
GN.213.030	115	45
240mm		



<b>Breisky Vienna Pattern</b>	<b>L mm</b>	<b>W mm</b>
GN.220.020	100	20
GN.220.025	100	25
GN.220.030	100	30
GN.220.035	100	35
GN.220.040	100	40
290mm		



<b>Breisky Vienna Pattern</b>	<b>L mm</b>	<b>W mm</b>
GN.223.180	180	40
370mm		



**Retractors self-retaining  
Haki automatyczne**

Vaginal retractor / Hak pochwowy



Autoclavable  
Możliwość sterylizacji w autoklawie



**GN.330.010**  
Frame only  
Solo telaio  
Rama operacyjna



**GN.330.020**  
45 x 17 mm (L x W)



**GN.330.030**  
90 x 37 mm (L x W)



**GN.330.040**  
90 x 45 mm (L x W)

**O'Sullivan-O'Connor**

**GN.330.000**  
Set - Contents / Set - Componenti / Zestaw zawiera  
1 x GN.330.010  
1 x GN.330.020  
1 x GN.330.030  
1 x GN.330.040

Thyroid and vaginal retractor / Hak tarczycowy i pochwowy (do sromu)

Vaginal retractor / Hak pochwowy (do sromu)



**Friedman-Blairbell**  
**GN.290.100**  
100 mm / 4"



**Jolls**  
**GN.292.150**  
150 mm / 6"



**Comyns Berkeley**  
**GN.294.140**  
140 mm / 5 1/2"





**Retractors self-retaining**  
**Haki automatyczne**



Autoclavable  
Możliwość sterylizacji w autoklawie

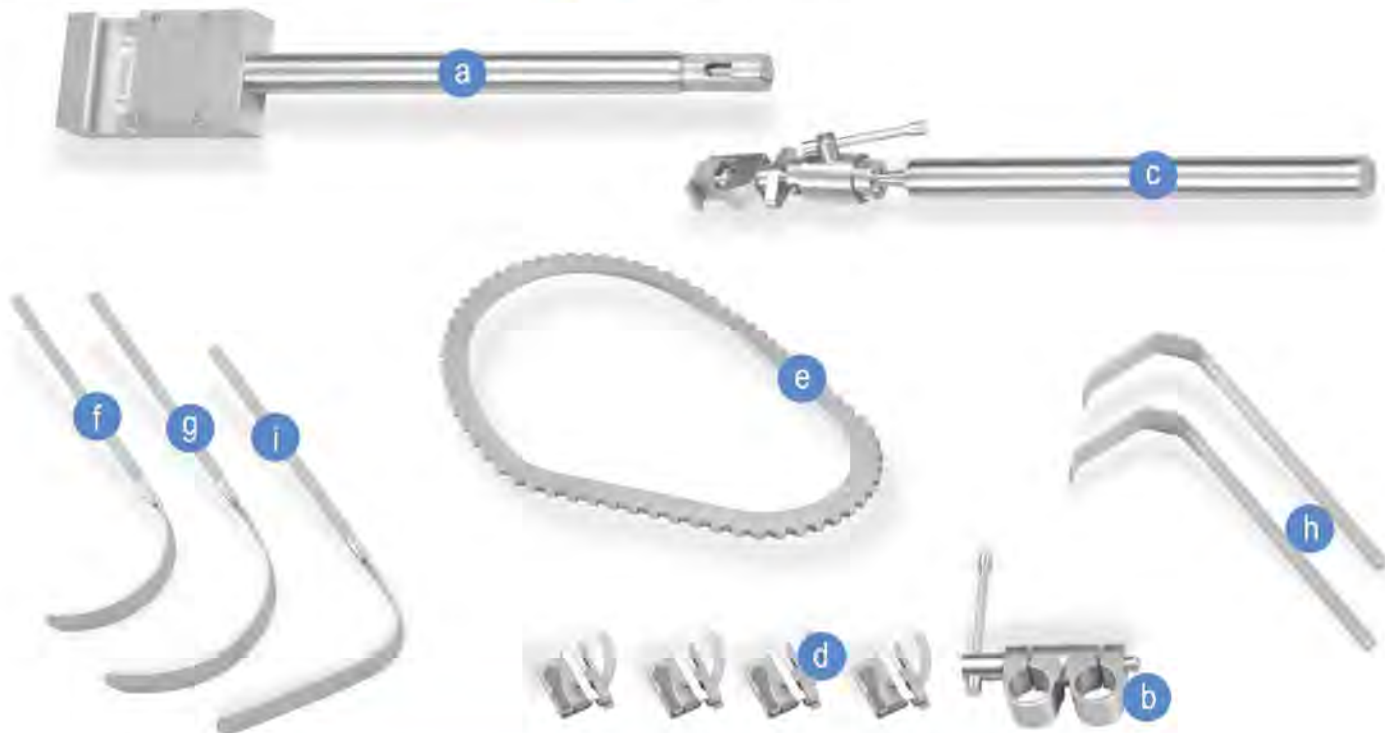

**A34-028-01R**

**Contents:**

<b>A</b>	1 x	A34-040-30R	Field Post/Table Clamp 305mm / 12"
<b>B</b>	1 x	A34-044-25R	Fixation clamp/post coupling rotatable 25mm / 1"
<b>C</b>	1 x	A34-050-47R	Fixation horizontal flex bar 360° rotatable 470mm / 18 ½"
<b>D</b>	4 x	A34-080-21R	Ratchet mechanism tilting
<b>E</b>	1 x	A34-148-26R	Ring fixed vaginal 20°. 267 x 203mm / 10 ½ x 8"
<b>F</b>	1 x	A34-210-31R	Blade fixed Deaver 89 x 25mm / 3 ½ x 1"
<b>G</b>	1 x	A34-210-34R	Blade fixed Deaver 127 x 25mm / 5 x 1"
<b>H</b>	2 x	A34-216-92R	Blade fixed vaginal Magrina lateral 76 x 25mm / 3 x 1"
<b>I</b>	1 x	A34-216-96R	Blade fixed vaginal Magrina posterior 114 x 25mm / 4 ½ x 1"

**A34-028-01R**

**Zawiera:**

<b>A</b>	1 x	A34-040-30R	Ramię pionowe z zaciskiem szynowym 305mm / 12"
<b>B</b>	1 x	A34-044-25R	Złącze kołowe obrotowe 25mm / 1"
<b>C</b>	1 x	A34-050-47R	Lekkie ramię horyzontalne 360° obrotowe 470mm / 18 ½"
<b>D</b>	4 x	A34-080-21R	Zaczep do łyżek przechyłowy
<b>E</b>	1 x	A34-148-26R	Rama operacyjna do system haków automatyczne 20° 267 x 203mm / 10 ½ x 8"
<b>F</b>	1 x	A34-210-31R	Łyżka brzuszna Deaver 89 x 25mm / 3 ½ x 1"
<b>G</b>	1 x	A34-210-34R	Łyżka brzuszna Deaver 127 x 25mm / 5 x 1"
<b>H</b>	2 x	A34-216-92R	Łyżka brzuszna Magrina lateral 76 x 25mm / 3 x 1"
<b>I</b>	1 x	A34-216-96R	Łyżka brzuszna Magrina posterior 114 x 25mm / 4 ½ x 1"



**Vaginal retractor**  
**Hak pochwowy**



Autoclavable  
Możliwość sterylizacji w autoklawie

Falcon Lateral Vaginal Retractor  
Fits in speculum yoke to provide better visualization without the need for manual intervention. Lateral wall retractors are recommended to be used with Grave Wide-View Speculum.



Falcon	L mm	W mm
GN.285.250	55	20
250mm		

**Endo specula**  
**Wzierniki endo**



**Kogan**  
GN.274.040 240mm



**Kogan**  
GN.276.040 240mm



**Kogan**  
GN.275.030 240mm



**Kogan**  
GN.275.040 240mm



**Uterine dilators**  
**Rozszerzadła do szyjki macicy**



Autoclavable  
Możliwość sterylizacji w autoklawie

	Full sizes Rozmiary pełne			Half sizes Rozmiary połówkowe	
	Hegar	mm Ø		Hegar	mm Ø
	GO.020.010	1		GO.022.015	1.5
	GO.020.020	2		GO.022.025	2.5
	GO.020.030	3		GO.022.035	3.5
	GO.020.040	4		GO.022.045	4.5
	GO.020.050	5		GO.022.055	5.5
	GO.020.060	6		GO.022.065	6.5
	GO.020.070	7		GO.022.075	7.5
	GO.020.080	8		GO.022.085	8.5
	GO.020.090	9		GO.022.095	9.5
	GO.020.100	10		GO.022.105	10.5
	GO.020.110	11		GO.022.115	11.5
	GO.020.120	12		GO.022.125	12.5
	GO.020.130	13		GO.022.135	13.5
	GO.020.140	14		GO.022.145	14.5
	GO.020.150	15		GO.022.155	15.5
	GO.020.160	16		GO.022.165	16.5
	GO.020.170	17		GO.022.175	17.5
	GO.020.180	18		GO.022.185	18.5
	GO.020.190	19		GO.022.195	19.5
	GO.020.200	20		GO.022.205	20.5
	GO.020.210	21		GO.022.215	21.5
	GO.020.220	22		GO.022.225	22.5
	GO.020.230	23		GO.022.235	23.5
	GO.020.240	24		GO.022.245	24.5
	GO.020.250	25			
	GO.020.260	26			
	GO.020.270	27			
	GO.020.280	28			
	GO.020.290	29			
	GO.020.300	30			
	180mm			180mm	



**Hegar Dilators Sets**

In canvas roll	Contents
GO.021.010	Set of 14 from size 4 to 17 mm
GO.021.020	Set of 26 from size 1 to 26 mm
GO.023.010	Set of 14 from size 4.5 to 17.5 mm
GO.023.020	Set of 26 from size 1.5 to 26.5 mm

**Zestaw rozszerzadeł Hegar**

W płóciennej etui	Zawiera
GO.021.010	Zestaw 14 sztuk roz od 4 do 17 mm
GO.021.020	Zestaw 26 sztuk roz od 1 do 26 mm
GO.023.010	Zestaw 14 sztuk roz od 4.5 do 17.5 mm
GO.023.020	Zestaw 26 sztuk roz od 1.5 do 26.5 mm



**Uterine dilators**  
**Rozszerzadła do szyjki macicy**



Autoclavable  
Możliwość sterylizacji w autoklawie



**Hegar Dilators Sets**

In stainless steel box	Contents
GO.021.030	Set of 14 from size 4 to 17 mm
GO.021.040	Set of 26 from size 1 to 26 mm
GO.023.030	Set of 14 from size 4.5 to 17.5 mm
GO.023.040	Set of 26 from size 1.5 to 26.5 mm

**Zestaw rozszerzadeł Hegar**

W stalowym pudełku	Zawiera
GO.021.030	Zestaw 14 sztuk roz od 4 do 17 mm
GO.021.040	Zestaw 26 sztuk roz od 1 do 26 mm
GO.023.030	Zestaw 14 sztuk roz od 4.5 do 17.5 mm
GO.023.040	Zestaw 26 sztuk roz od 1.5 do 26.5 mm



Hegar	mm Ø
GO.050.020	ø 1/2mm
GO.050.040	ø 3/4mm
GO.050.060	ø 5/6mm
GO.050.080	ø 7/8mm
GO.050.100	ø 9/10mm
GO.050.120	ø 11/12mm
GO.050.140	ø 13/14mm
GO.050.160	ø 15/16mm
GO.050.180	ø 17/18mm
GO.050.200	ø 19/20mm
GO.050.220	ø 21/22mm
GO.050.240	ø 23/24mm
GO.050.260	ø 25/26mm
200mm	



**Hegar Dilator sets**

In canvas roll	Contents
GO.051.010	Set of 8 from size 3/4 to 17/18 mm
GO.051.020	Set of 13 from size 1/2 to 25/26 mm

**Zestaw rozszerzadeł Hegar**

W płóciennej etui	Zawiera
GO.051.010	Zestaw 8 sztuk roz od 3/4 to 17/18 mm
GO.051.020	Zestaw 13 sztuk roz od 1/2 to 25/26 mm



**Uterine Sounds, Manipulator and Depressors , Tubal Hook**  
**Rozszerzadła do szyjki macicy**



Autoclavable  
Możliwość sterylizacji w autoklawie



**Martin**  
33.273-32  
320mm  
Rigid  
Sztywna

**Sims**  
GN.355.010  
320mm  
Malleable silver plated  
Giętka posrebrzana

**Sims**  
GN.356.010  
320mm  
Malleable stainless steel  
Giętka stal nierdzewna

**Sims**  
GN.357.010  
320mm  
Rigid stainless steel  
Sztywna stal nierdzewna

**Ramathibodi**  
GO.533.275  
275mm  
Uterine manipulator  
Zgłębnik ginekologiczny

**Ramathibodi**  
GO.534.250  
250mm  
Tubal hook  
Sonda ginekologiczna

**Braun**  
GN.267.270  
280mm

**Sims**  
GN.268.260  
260mm  
Depressor uterine  
Łopátka ginekologiczna



**Uterine Dressing Forceps**  
**Kleszcze do materiałów opatrunkowych**



Autoclavable  
Możliwość sterylizacji w autoklawie

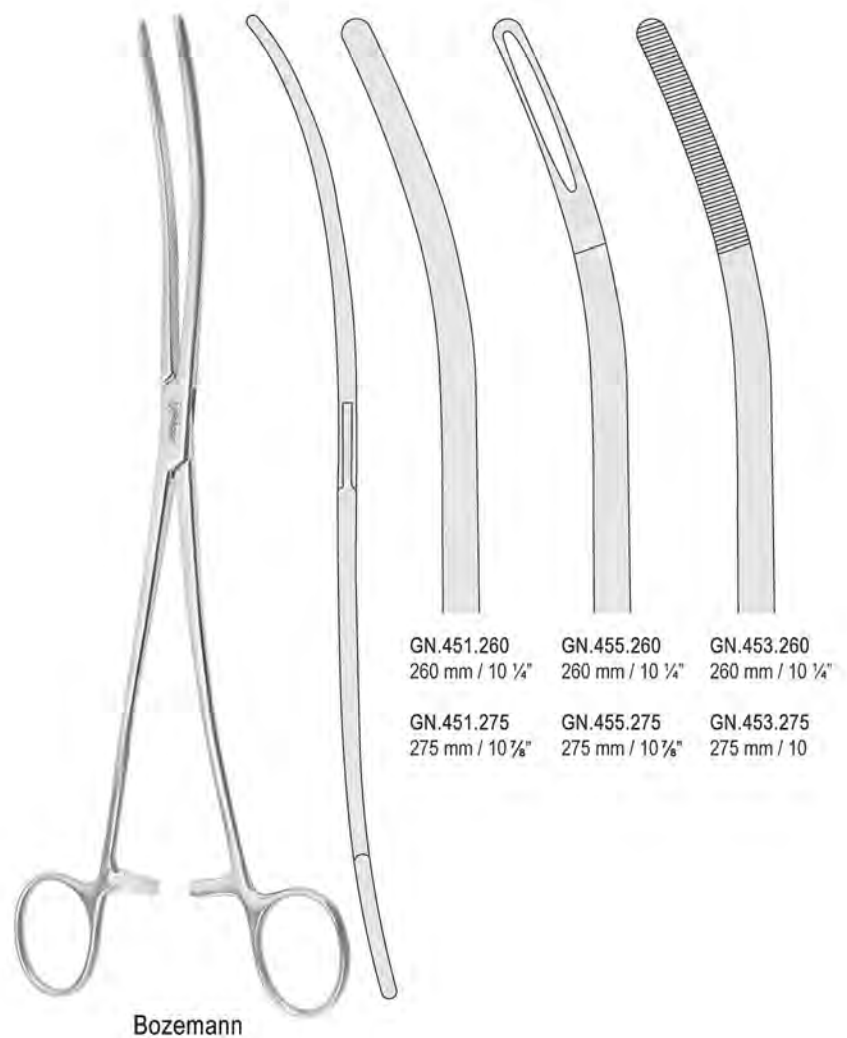
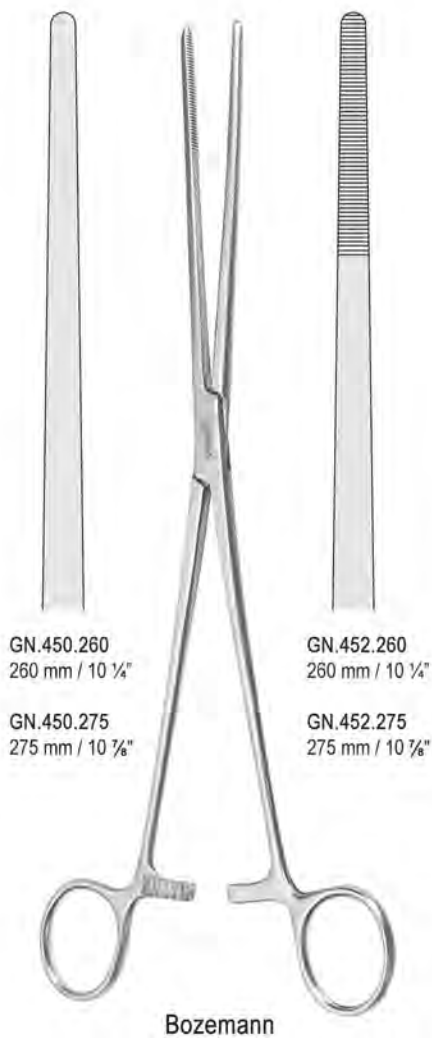



**Uterine dressing forceps**  
**Kleszcze do materiałów opatrunkowych**



Autoclavable  
Możliwość sterylizacji w autoklawie

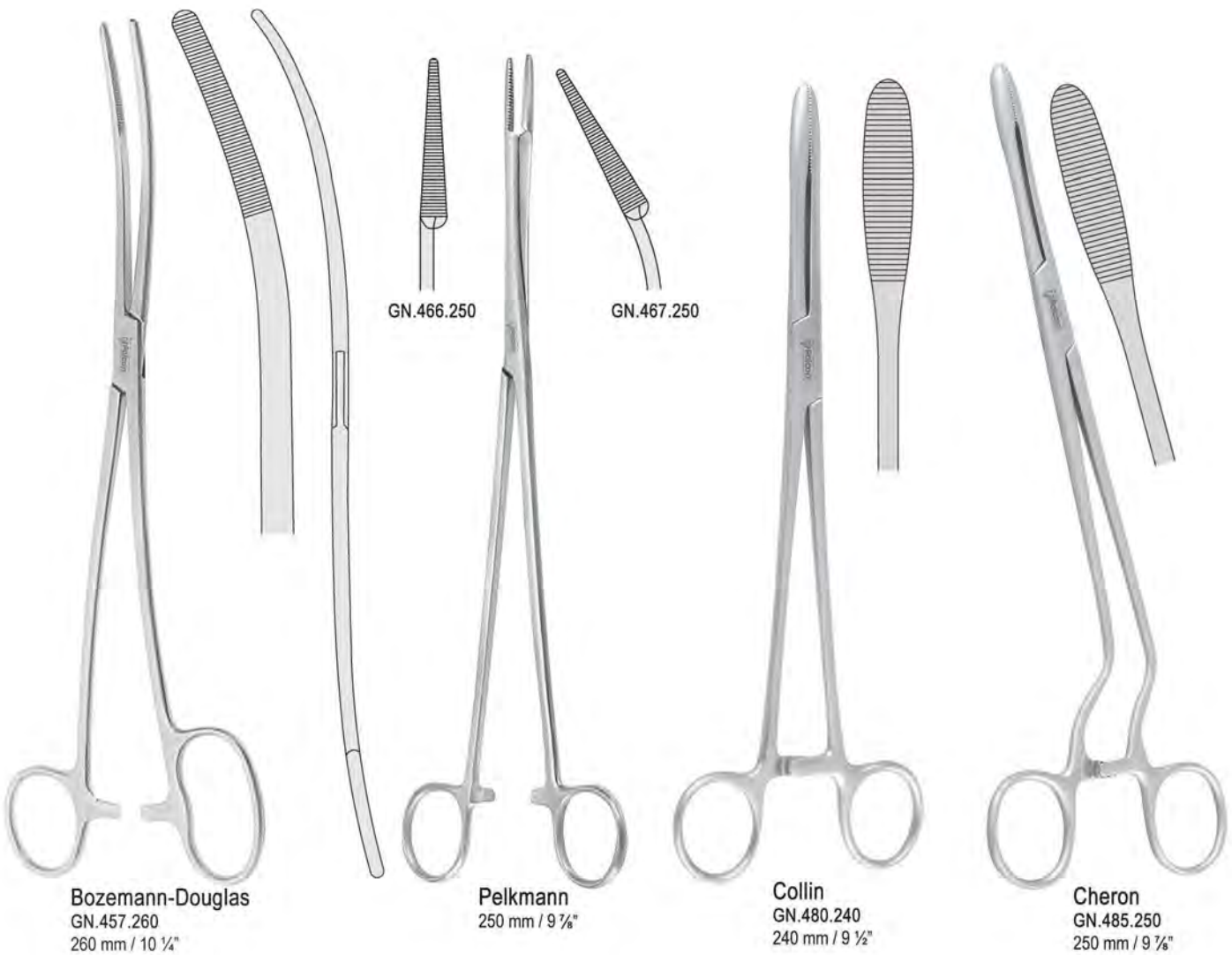



**Uterine Dressing Forceps**  
**Kleszcze do materiałów opatrunkowych**



Autoclavable  
Możliwość sterylizacji w autoklawie



BF.080.280



BF.081.280



**Sims-Maier**  
280 mm / 11"



**Noto**  
GN.502.280  
280 mm / 11"

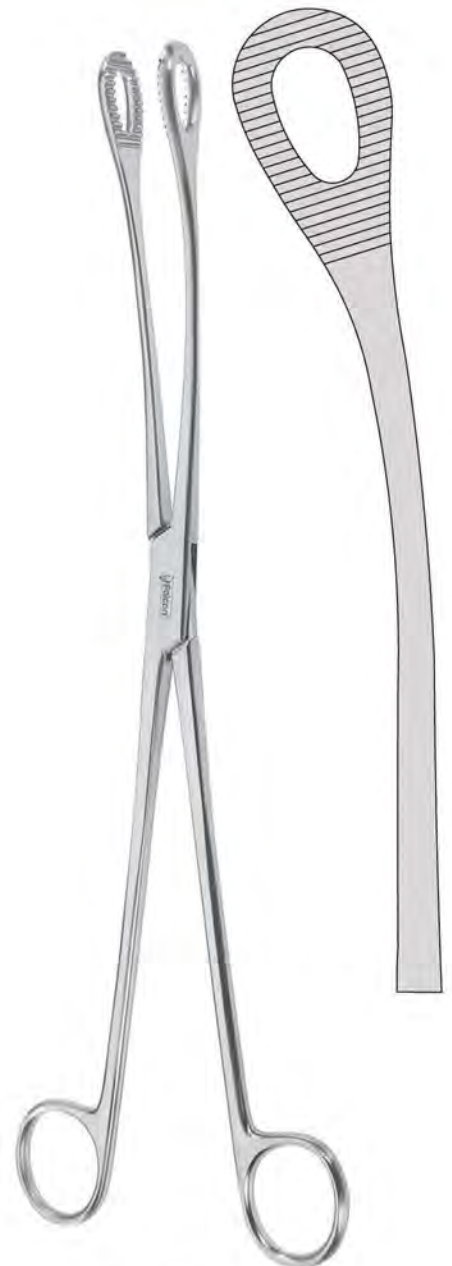

**Kelly**  
GN.495.320  
320 mm / 12 1/2"





**Uterine Tenaculum Forceps**  
**Kulociągi pojedyncze**



Autoclavable  
Możliwość sterylizacji w autoklawie



**Bernhard**  
BF.450.160  
160mm



**Staude-Moore**  
GN.700.170  
170 mm



**Barrett**  
GN.704.180  
180 mm



**Braun**  
GN.710.250  
250mm



**Schroeder-Luer**  
GN.714.250  
250mm

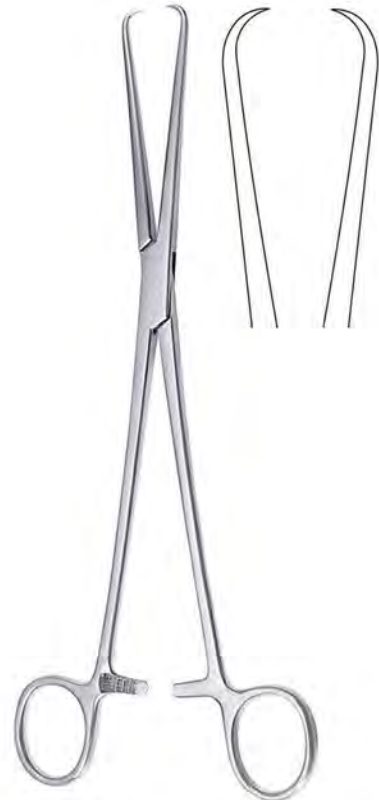

**Pozzi**  
GN.716.230  
250mm



Uterine tenaculum forceps  
Kulociągi pojedyncze



Autoclavable  
Możliwość sterylizacji w autoklawie



Pozzi-Collin  
GN.718.250  
250mm



Duplay  
GN.737.280  
280mm



Skene  
GN.745.230  
240mm



**Uterine Tenaculum and Vulsellum Forceps**  
**Kulociągi**



Autoclavable  
Możliwość sterylizacji w autoklawie

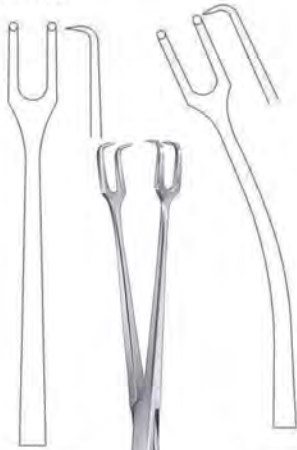

GN.874.250

GN.875.010



**Schroeder**  
250mm

Curved to side  
Wygięty na bok



**Schroeder**  
GN.875.040  
250mm



**Czerny**  
GN.880.210  
210 mm



**Pratt / Billroth**  
GO.596.270  
280mm

Curved to side  
Wygięty na bok



**Teale**  
GN.801.180  
180mm  
GN.801.230  
230mm



**Littlewood**  
BG.530.190  
190mm

Uterine tenaculum forceps  
Kulociągi pojedyncze



Autoclavable  
Możliwość sterylizacji w autoklawie

Curved to side  
Wygięty na bok



Jacob  
GN.840.210  
210 mm



Jacob  
GN.841.210  
210 mm



6mm  
GN.864.060

8mm  
GN.864.080

10mm  
GN.864.100

Museux  
240 mm

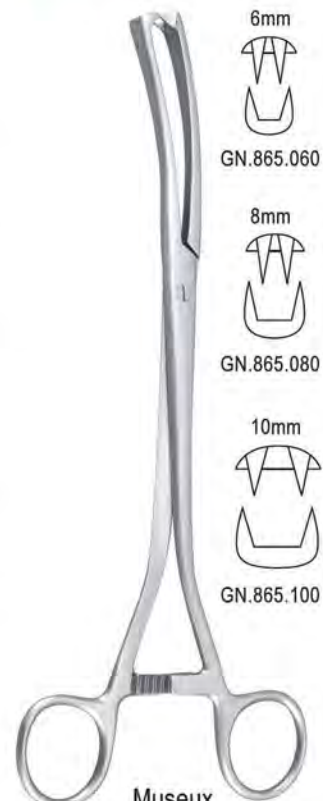

6mm  
GN.865.060

8mm  
GN.865.080

10mm  
GN.865.100

Museux  
240 mm

Polypus and ovum forceps, Cervix manipulating forceps  
Kleszcze ginekologiczne do jaja płodowego i polipów



Bonney  
GN.512.240  
240mm



Vant  
GN.515.240  
240mm



With malleable sound  
Z giętką sondą

Hulka  
GO.469.280  
280mm



**Uterine elevating forceps**  
**Kleszcze ginekologiczne do jaja płodowego**



Autoclavable  
Możliwość sterylizacji w autoklawie



**Dartigues**  
GN.934.270  
270mm

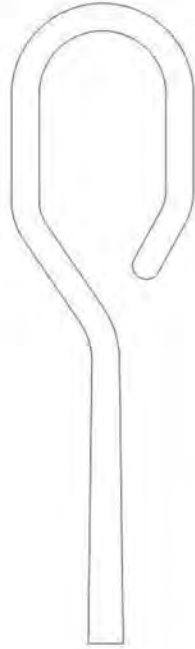

**Somer**  
GN.939.235  
230mm



**Myoma instruments**  
**Instrumenty do mięśniaków macicy**



Knife myoma double-edge  
Nóż do mięśniaków macicy zagięty

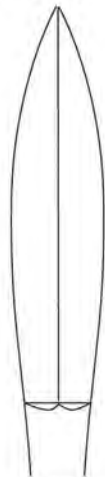

Screw myoma  
Świder do mięśniaków macicy



**Doyen**  
GO.590.020  
170mm

Screw myoma  
Świder do mięśniaków macicy



**Doyen**  
GO.590.010  
170mm



**Fistula Hooks  
Haczyki**



Autoclavable  
Możliwość sterylizacji w autoklawie

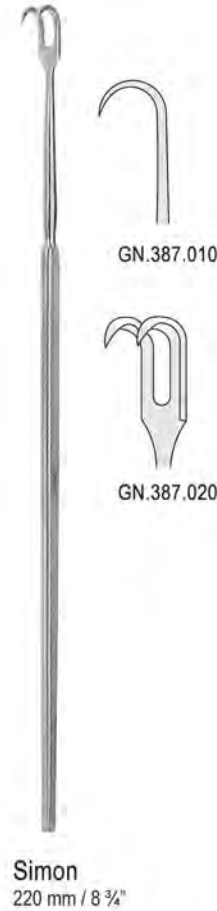
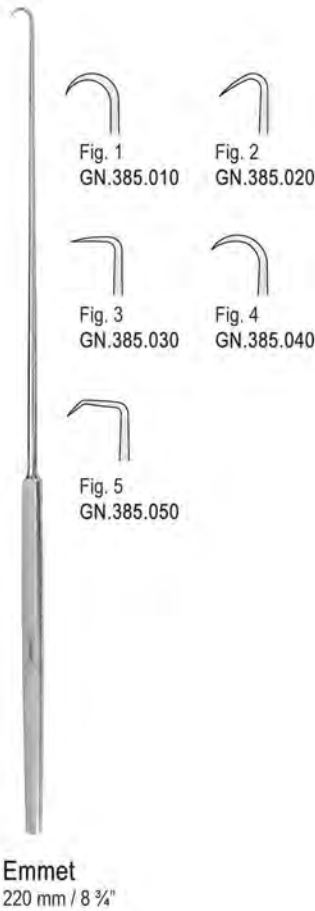

**Instruments for Removal of intra uterine devices  
Instrumenty do usuwania wkładek wewnątrzmacicznych**

Hook IUD removing  
Haczyk do usuwania wkładek IUD



**Saunders / Grafenberg**  
GO.515.320  
310mm

Forceps IUD removing  
Kleszcyki do usuwania wkładek IUD

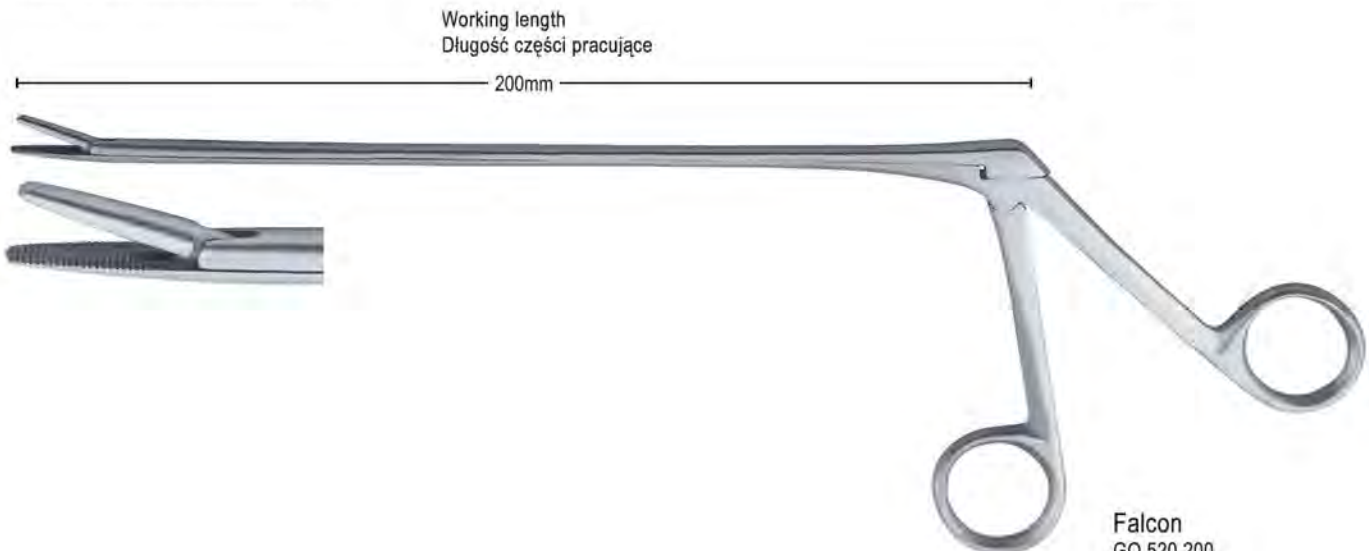



**Biopsy curettes**  
**Skrobaczki do biopsji**



Autoclavable  
Możliwość sterylizacji w autoklawie



**Novak-Schoreckaert**  
GO.245.020 Ø2 x 240mm  
GO.245.030 Ø3 x 240mm  
GO.245.040 Ø4 x 240mm



**Randall**  
GO.249.040  
Ø4 x 240mm

3 x 12 mm



**Kevorkian-Young**  
GO.220.020  
300mm

3 x 12 mm



**Kevorkian-Young**  
GO.220.010  
300mm

**Cervical biopsy forceps**  
**Kleszcze do pobierania wycinków**

4.5 x 8mm



**Schubert**  
GO.365.260 260mm

8 x 5mm

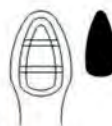

**Faure**  
GO.361.240 240mm

3 x 5mm

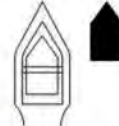

**Tischler**  
GO.367.270 270mm



**Cervical biopsy forceps**  
**Kleszcze do pobierania wycinków**



Autoclavable  
Możliwość sterylizacji w autoklawie

Working length  
Długość części pracujące

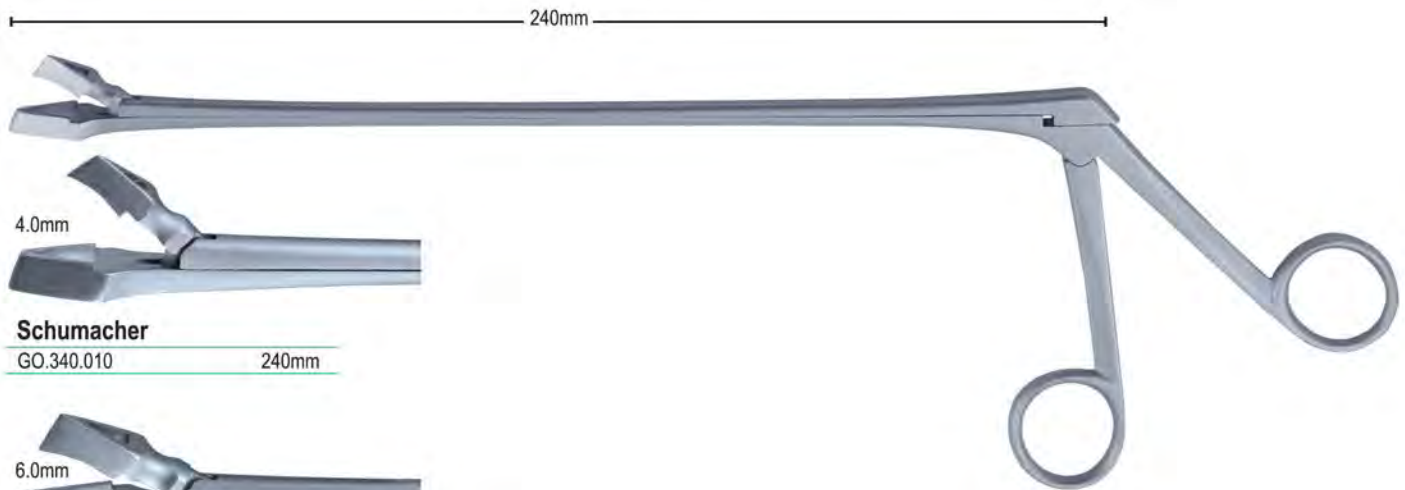

**Schumacher**

GO.340.010 240mm



**Schumacher**

GO.340.020 240mm

Working length  
Długość części pracujące

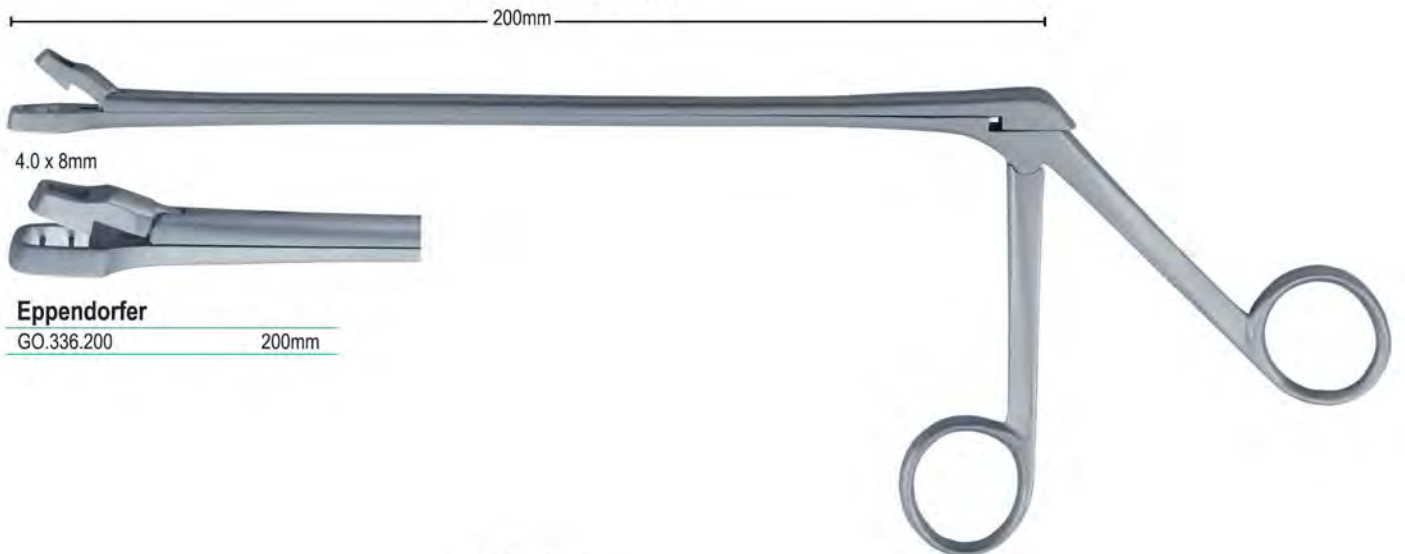

**Eppendorfer**

GO.336.200 200mm

Working length  
Długość części pracujące

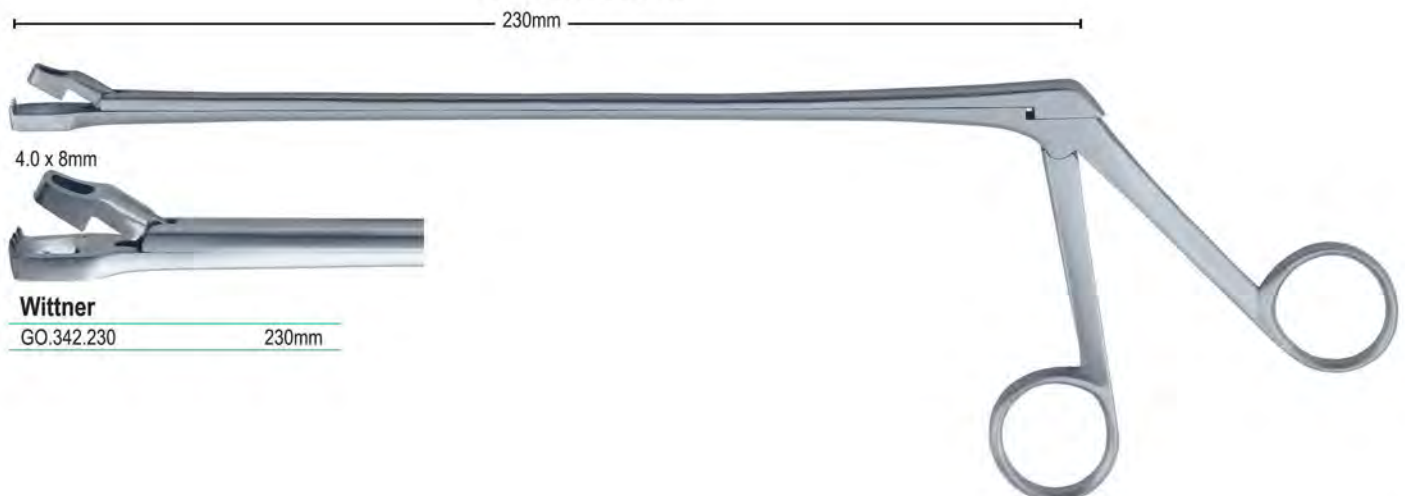

**Wittner**

GO.342.230 230mm





**Cervical biopsy forceps**  
**Kleszcze do pobierania wycinków**



Autoclavable  
Możliwość sterylizacji w autoklawie

Working length  
Długość części pracujące

230mm

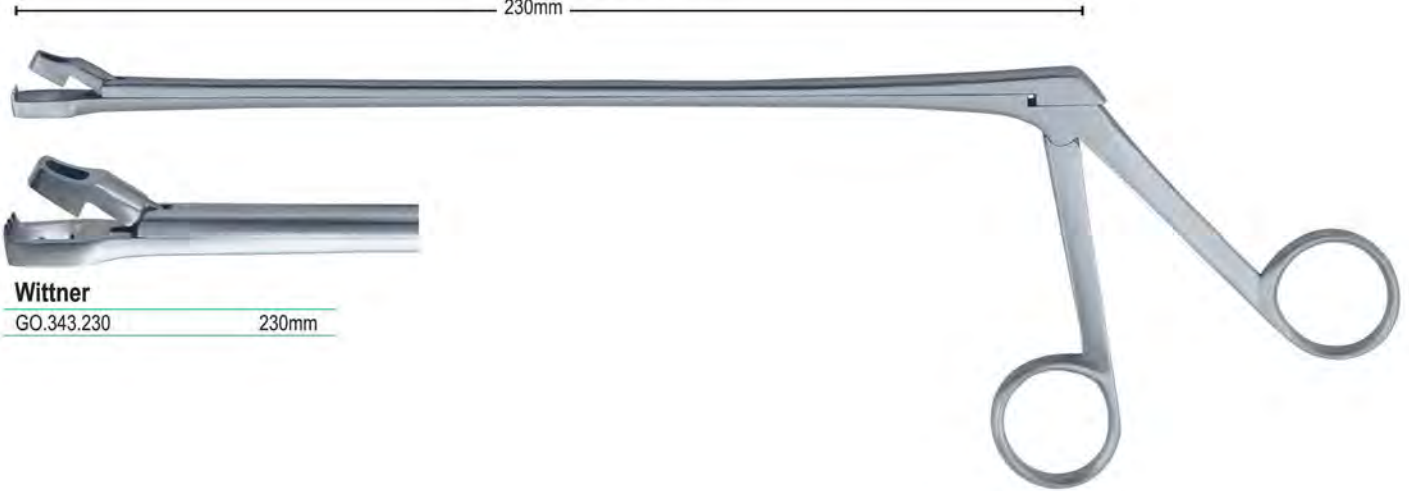

**Wittner**

GO.343.230

230mm

Working length  
Długość części pracujące

200mm

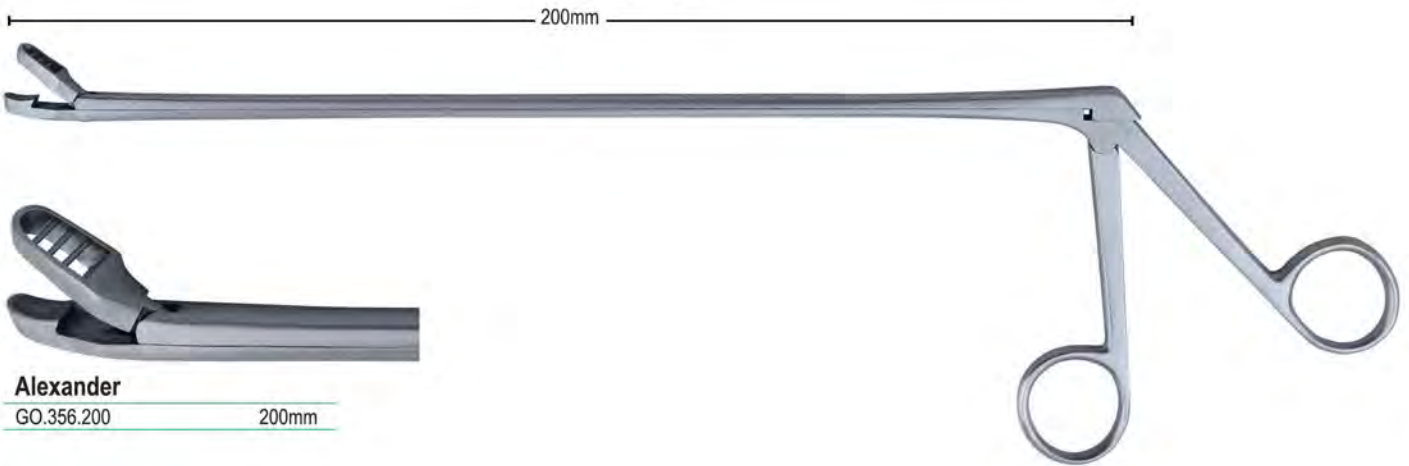

**Alexander**

GO.356.200

200mm

Working length  
Długość części pracujące

280mm

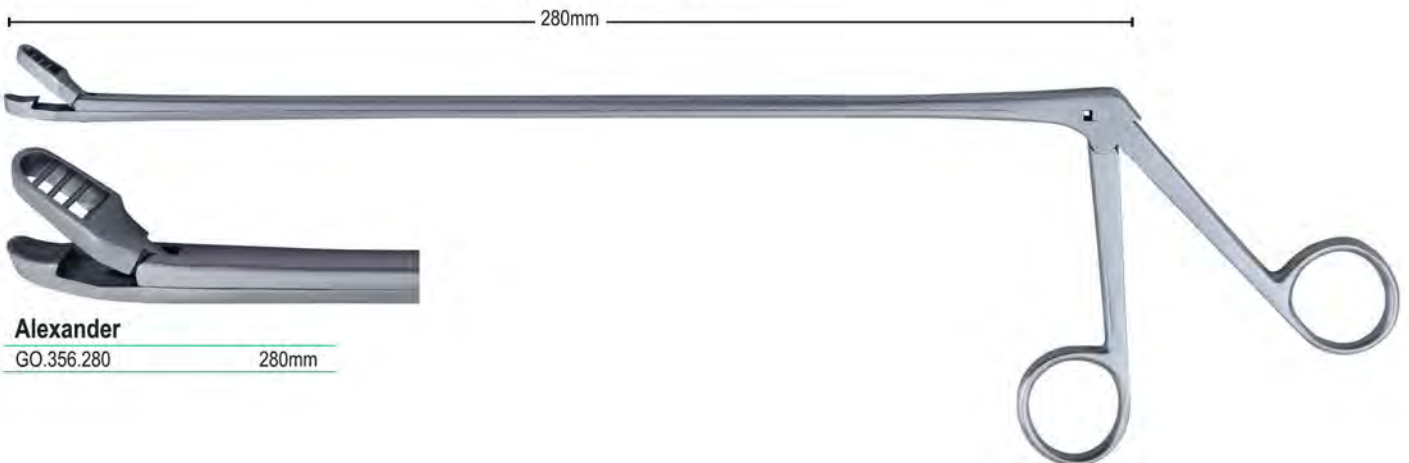

**Alexander**

GO.356.280

280mm

**Cervical biopsy forceps**  
**Kleszcze do pobierania wycinków**



Autoclavable  
Możliwość sterylizacji w autoklawie

Working length  
Długość części pracujące

250mm

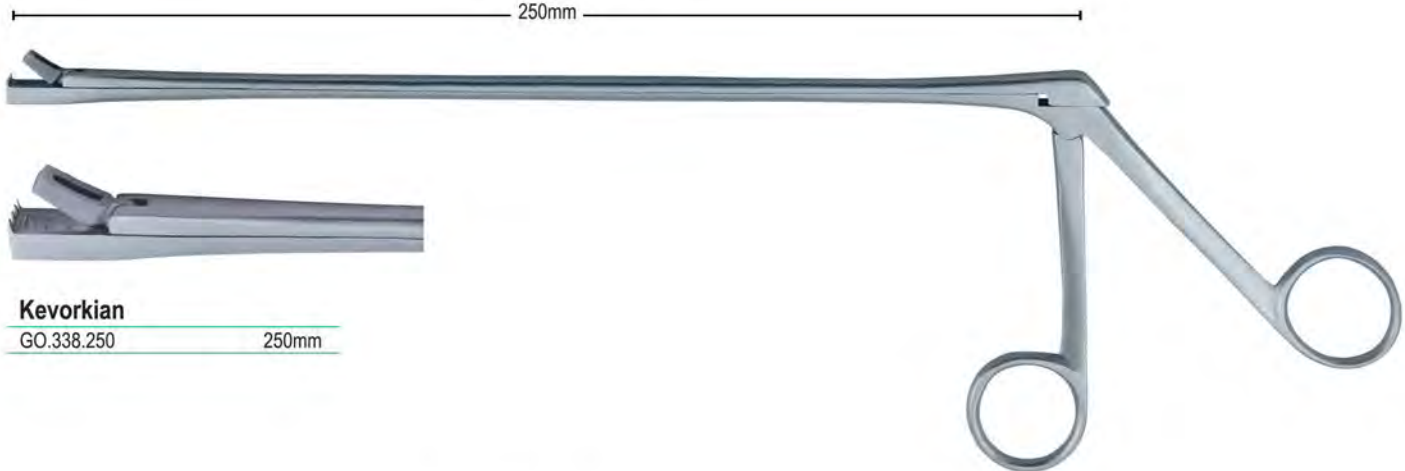

**Kevorkian**

GO.338.250 250mm

Working length  
Długość części pracujące

220mm

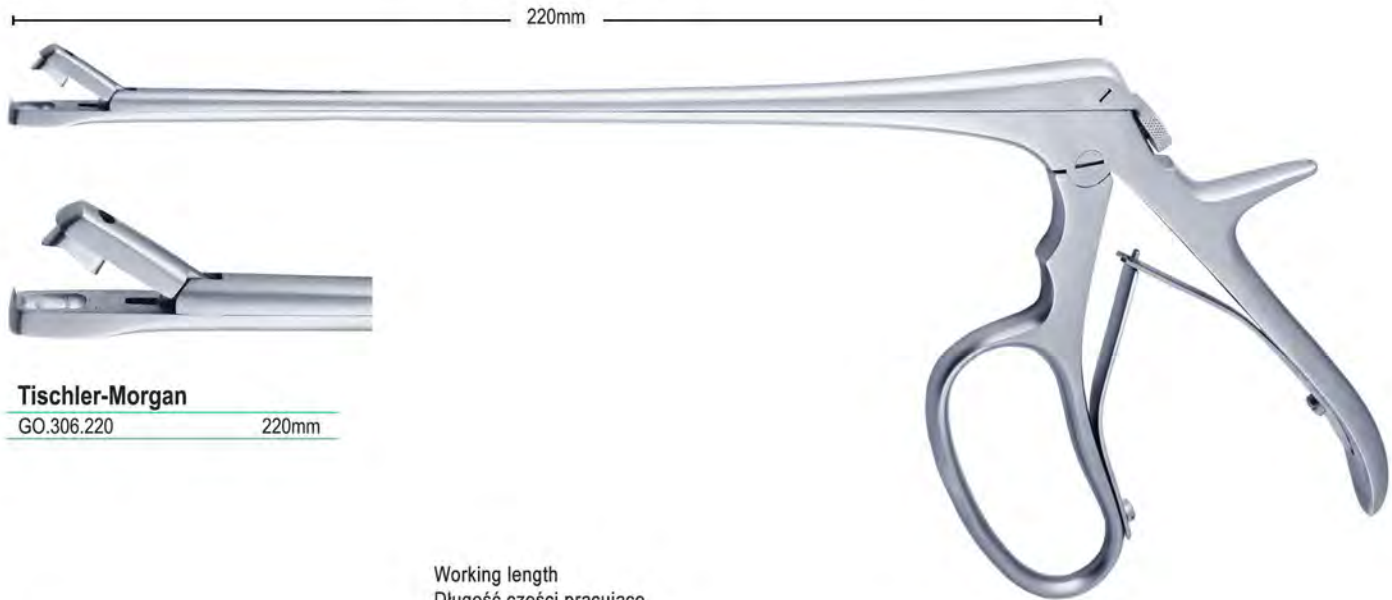

**Tischler-Morgan**

GO.306.220 220mm

Working length  
Długość części pracujące

220mm

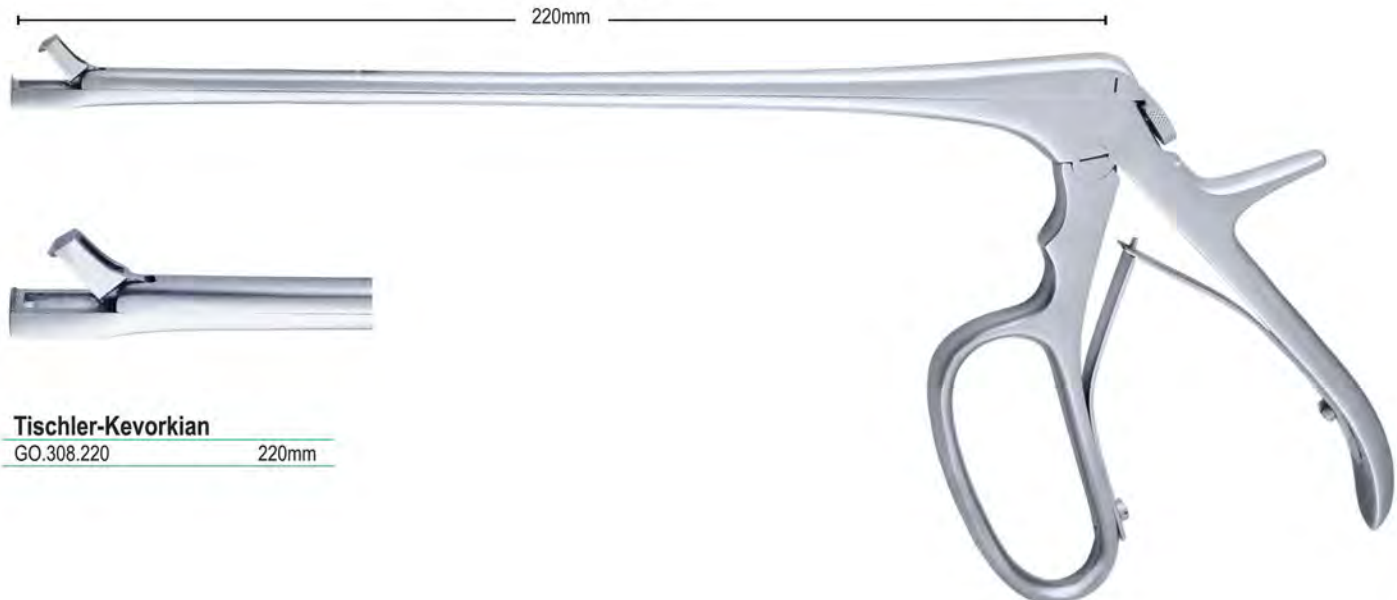

**Tischler-Kevorkian**

GO.308.220 220mm



**Cervical biopsy forceps**  
**Kleszcze do pobierania wycinków**

Working length  
Długość części pracujące



Autoclavable  
Możliwość sterylizacji w autoklawie

220mm

7 x 3 mm



**Tischler-Morgan**

GO.306.220 220mm

Working length  
Długość części pracujące

200mm

2.3 x 4 mm



**Tischler-Mini**

GO.290.200 200mm

Working length  
Długość części pracujące

220mm

7 x 4 mm



**Tischler**

GO.316.220 220mm



**Cervical biopsy forceps**  
**Kleszcze do pobierania wycinków**



Autoclavable  
Możliwość sterylizacji w autoklawie

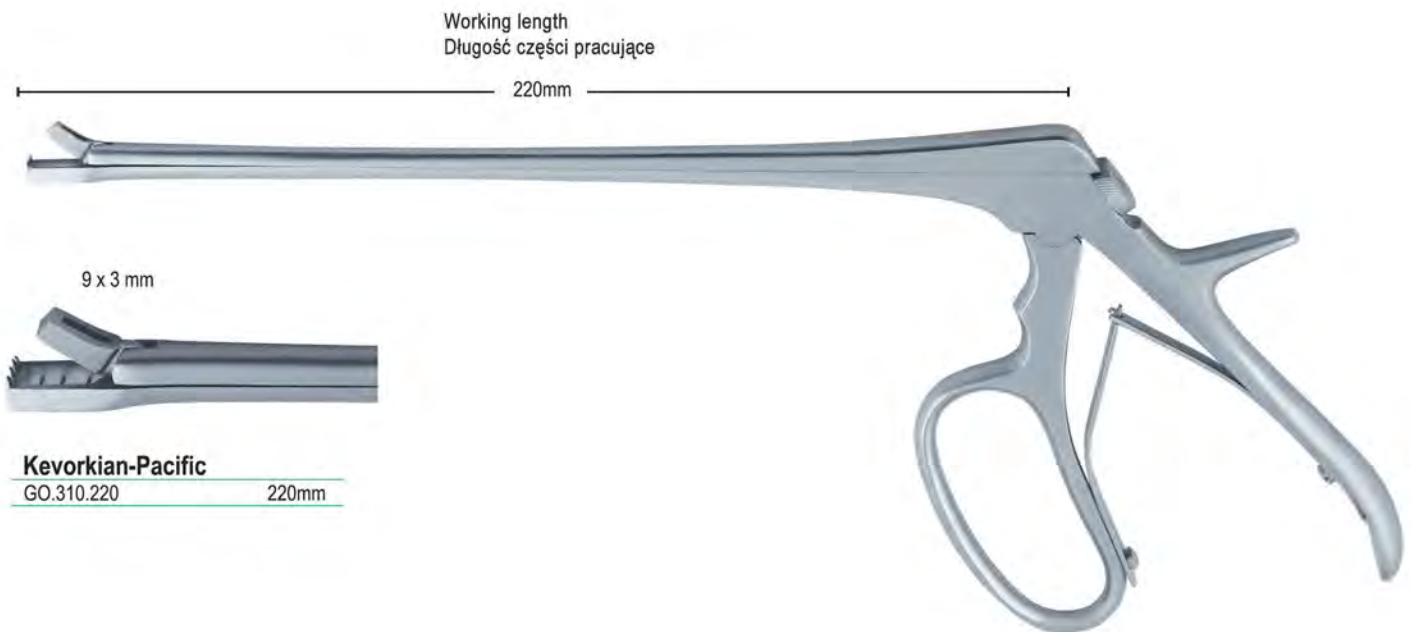

**Kevorkian-Pacific**

GO.310.220      220mm

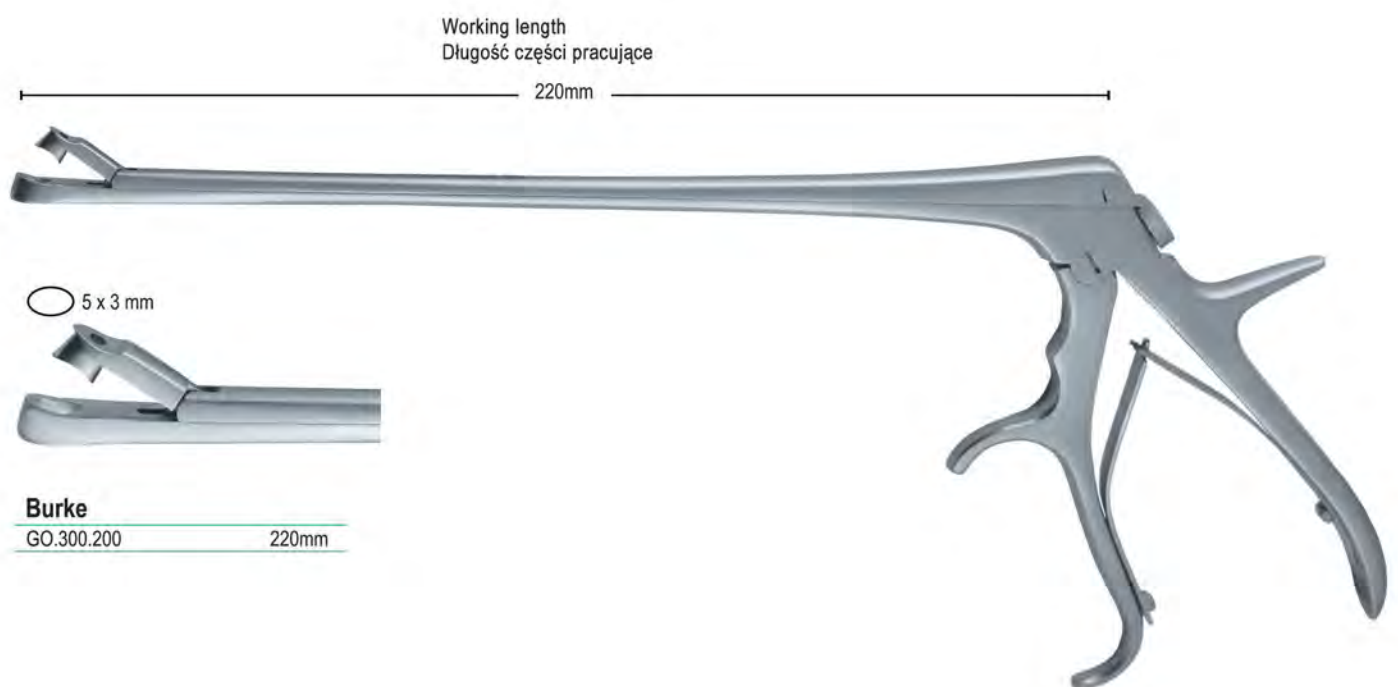

**Burke**

GO.300.200      220mm



**Uterine Curettes**  
**Skrobaczki maciczne**



Autoclavable  
Możliwość sterylizacji w autoklawie



5 mm  
Fig. 00



6 mm  
Fig. 0



7 mm  
Fig. 1



8 mm  
Fig. 2



9 mm  
Fig. 3



11 mm  
Fig. 4



12 mm  
Fig. 5

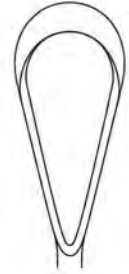

14 mm  
Fig. 6



**Sims**

280mm

		Blunt, malleable Tępe - giętkie	Blunt, rigid Tępe - sztywne	Sharp, malleable Ostre - giętkie	Sharp, rigid Ostre - sztywne
Fig. 00	5 mm	GO.123.050	GO.122.050	GO.121.050	GO.120.050
Fig. 0	6 mm	GO.123.060	GO.122.060	GO.121.060	GO.120.060
Fig. 1	7 mm	GO.123.070	GO.122.070	GO.121.070	GO.120.070
Fig. 2	8 mm	GO.123.080	GO.122.080	GO.121.080	GO.120.080
Fig. 3	9 mm	GO.123.090	GO.122.090	GO.121.090	GO.120.090
Fig. 4	11 mm	GO.123.110	GO.122.110	GO.121.110	GO.120.110
Fig. 5	12 mm	GO.123.120	GO.122.120	GO.121.120	GO.120.120
Fig. 6	14 mm	GO.123.140	GO.122.140	GO.121.140	GO.120.140

Uterine curettes  
Skrobaczki maciczne



Fig. 00



Fig. 0



Fig. 1



Fig. 2



Fig. 3



Fig. 4



Fig. 5



Fig. 6



Fig. 7



Fig. 8



Fig. 9



Fig. 10

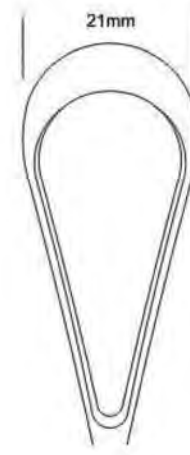

Fig. 11

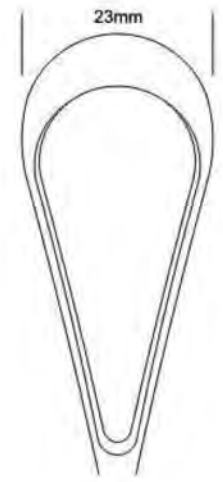

Fig. 12

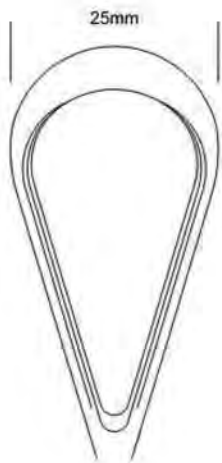

Fig. 13

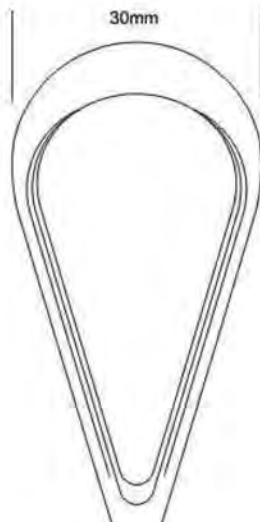

Fig. 14

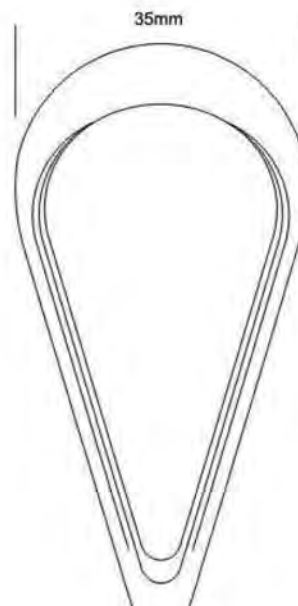

Fig. 15

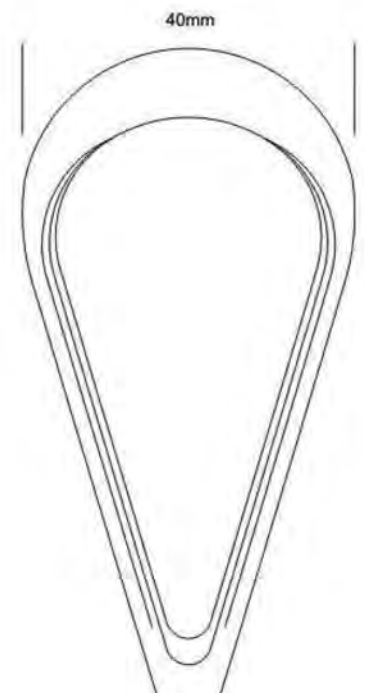

Fig. 16



**Uterine curettes**  
**Skrobaczki maciczne**



Autoclavable  
Możliwość sterylizacji w autoklawie



**Recamier-Bumm**

310mm

		<b>Blunt, malleable</b> Tępe - giętkie	<b>Blunt, rigid</b> Tępe - sztywne	<b>Sharp, malleable</b> Ostre - giętkie	<b>Sharp, rigid</b> Ostre - sztywne
Fig. 00	5 mm	GO.139.050	GO.138.050	GO.137.050	GO.136.050
Fig. 0	6 mm	GO.139.060	GO.138.060	GO.137.060	GO.136.060
Fig. 1	7 mm	GO.139.070	GO.138.070	GO.137.070	GO.136.070
Fig. 2	8 mm	GO.139.080	GO.138.080	GO.137.080	GO.136.080
Fig. 3	9 mm	GO.139.090	GO.138.090	GO.137.090	GO.136.090
Fig. 4	11 mm	GO.139.110	GO.138.110	GO.137.110	GO.136.110
Fig. 5	12 mm	GO.139.120	GO.138.120	GO.137.120	GO.136.120
Fig. 6	14 mm	GO.139.140	GO.138.140	GO.137.140	GO.136.140
Fig. 7	15 mm	GO.139.150	GO.138.150	GO.137.150	GO.136.150
Fig. 8	16 mm	GO.139.160	GO.138.160	GO.137.160	GO.136.160
Fig. 9	19 mm	GO.139.190	GO.138.190	GO.137.190	GO.136.190
Fig. 10	20 mm	GO.139.200	GO.138.200	GO.137.200	GO.136.200
Fig. 11	21 mm	GO.139.210	GO.138.210	GO.137.210	GO.136.210
Fig. 12	23 mm	GO.139.230	GO.138.230	GO.137.230	GO.136.230
Fig. 13	25 mm	GO.143.250	GO.142.250	GO.141.250	GO.140.250
Fig. 14	30 mm	GO.143.300	GO.142.300	GO.141.300	GO.140.300
Fig. 15	35 mm	GO.143.350	GO.142.350	GO.141.350	GO.140.350
Fig. 16	40 mm	GO.143.400	GO.142.400	GO.141.400	GO.140.400

Uterine curettes  
Skrobaczki maciczne



Autoclavable  
Możliwość sterylizacji w autoklawie

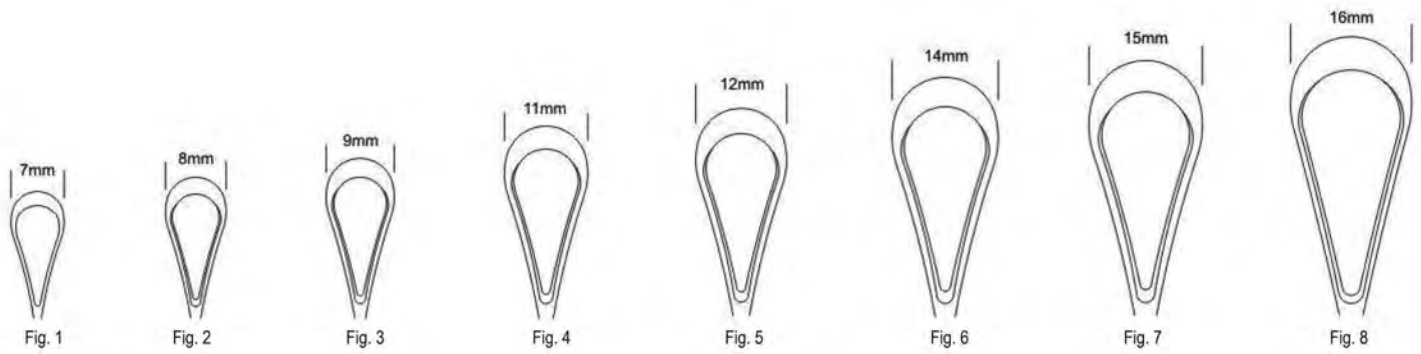

Blunt, rigid  
Tępe - sztywne



Sharp, rigid  
Ostre - sztywne



**Recamier-Bumm**

310mm

GO.136.000

GO.136.000

**Sharp, rigid**

Ostre - sztywne

Contents / Zawiera

Set of 8 from fig. 1 to 8

Zestaw 8szt. od fig. 1 do 8

**Recamier-Bumm**

310mm

GO.138.000

GO.138.000

**Blunt, rigid**

Tępe - sztywne

Contents / Zawiera

Set of 8 from fig. 1 to 8

Zestaw 8szt. od fig. 1 do 8





**Uterine Curettes**  
**Skrobaczki maciczne**



Autoclavable  
Możliwość sterylizacji w autoklawie



**Bumm**  
Malleable  
Giętka  
290mm



Blunt / Tępe	GO.151.160	GO.151.180	GO.151.195
Sharp / Ostre	GO.149.160	GO.149.180	GO.149.195

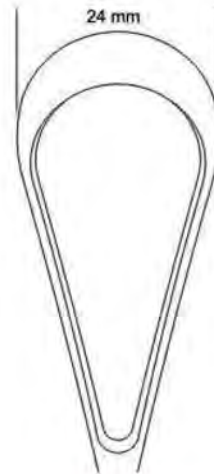
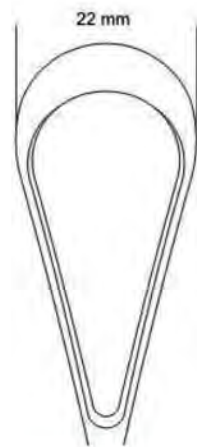

Blunt / Tępe	GO.151.215	GO.151.235
Sharp / Ostre	GO.149.215	GO.149.235

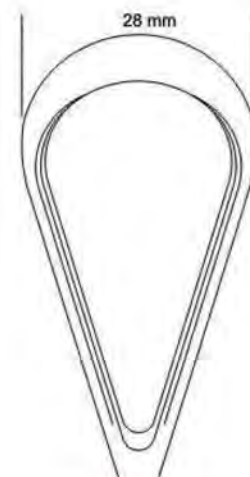
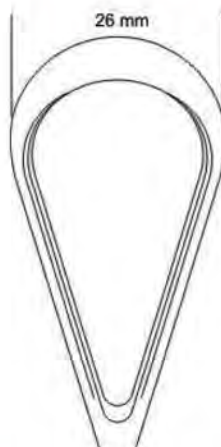

Blunt / Tępe	GO.151.260	GO.151.260
Sharp / Ostre	GO.149.285	GO.149.285

**Intra-uterine cannula**  
**Kaniule ginekologiczne**



Autoclavable  
Możliwość sterylizacji w autoklawie

Ø 10 x 25mm



GO.434.010

Ø 13 x 25mm



GO.434.020

Ø 16 x 30mm



GO.434.030



GO.429.010

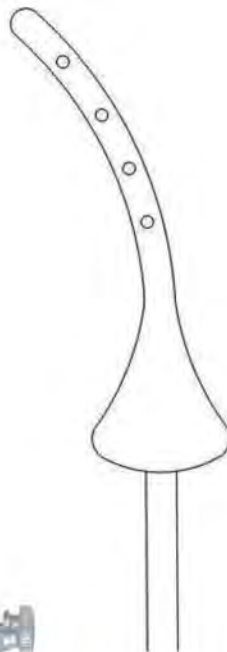

GO.429.020

Spare cone only silicon  
Nasadka silikonowa do  
kaniul Spackmann/Curie



GO.421.010



Leech Wilkinson  
265mm



Spackmann  
Silver plated  
Posrebrzana  
360mm



Spackmann  
GO.421.360  
360mm



Currie (Jarcho)  
GO.423.360  
360mm



Fetal stethoscopes and pelvimeters  
Stetoskopy do badania tętna płodu i miednicomierze



Autoclavable  
Możliwość sterylizacji w autoklawie



Aluminum  
Aluminiowy

S3

**Pinard**  
GO.705.150  
150 mm / 6"



Plastic  
Plastikowy

S5

**Pinard**  
GO.706.150  
150 mm / 6"



Wooden  
Drewniany

S5

**Pinard**  
GO.707.170  
170 mm / 6 3/4"



**Collyer**  
GO.712.300  
300 mm  
cm/inch scale



**Breisky**  
GO.710.330  
330 mm  
cm/inch scale



**Collin**  
34-005-35  
350 mm  
cm scale



Instruments for Amnion Bladder  
Instrumenty do pęcherza płodowego



Autoclavable  
Możliwość sterylizacji w autoklawie



Iowa

GO.722.140

140 mm



Beecham

GO.765.260

260 mm



Iowa

GO.773.260

265 mm



Caesarean forceps  
Kleszczyki do chwytania skóry na główce płodu



Autoclavable  
Możliwość sterylizacji w autoklawie



**Green-Armytage**  
GO.780.210 210mm



**Green-Armytage**  
GO.783.195 200mm



**Willet**  
BG.702.190 190mm



**Ovum-Placenta forceps**  
**Kleszczyki do jaja płodowego i łożyska**



Autoclavable  
Możliwość sterylizacji w autoklawie



**McClintock**

GO.851.240 240mm



**Greenhalgh-Corey**

GO.853.240 240mm



**Moore**

GO.849.240 240mm



**Ovum-Placenta forceps**  
**Kleszczki do łaia łożwca i łożvska**



Autoclavable  
Możliwość sterylizacji w autoklawie



GO.868.010



GO.869.010



GO.858.275



GO.859.275



GO.868.020



GO.869.020



**Winter**

280mm



GO.868.030



GO.869.030



**Saenger**

270mm

**Obstetrical forceps and hooks**  
**Kleszcze porodowe i Hak położniczy**



Autoclavable  
Możliwość sterylizacji w autoklawie



**Naegle**

GO.814.355	355 mm
GO.814.400	400 mm



**Wrigley**

GO.802.280	280 mm
------------	--------



**Simpson-Braun**

GO.812.360	360 mm
------------	--------



**Braun**

GO.930.305	305 mm
------------	--------





**Ovum-Placenta curettes and scoops**  
**Skrobaczki i łyżeczki do jaja płodowego oraz łożyska**



Autoclavable  
Możliwość sterylizacji w autoklawie



**Pestalozza**  
GO.895.010 300 mm

**Cuzzi** 300 mm

**Wallich**  
GO.899.030 270 mm

**Uterine scissors**  
**Nożyczki maciczne**



Autoclavable  
Możliwość sterylizacji w autoklawie

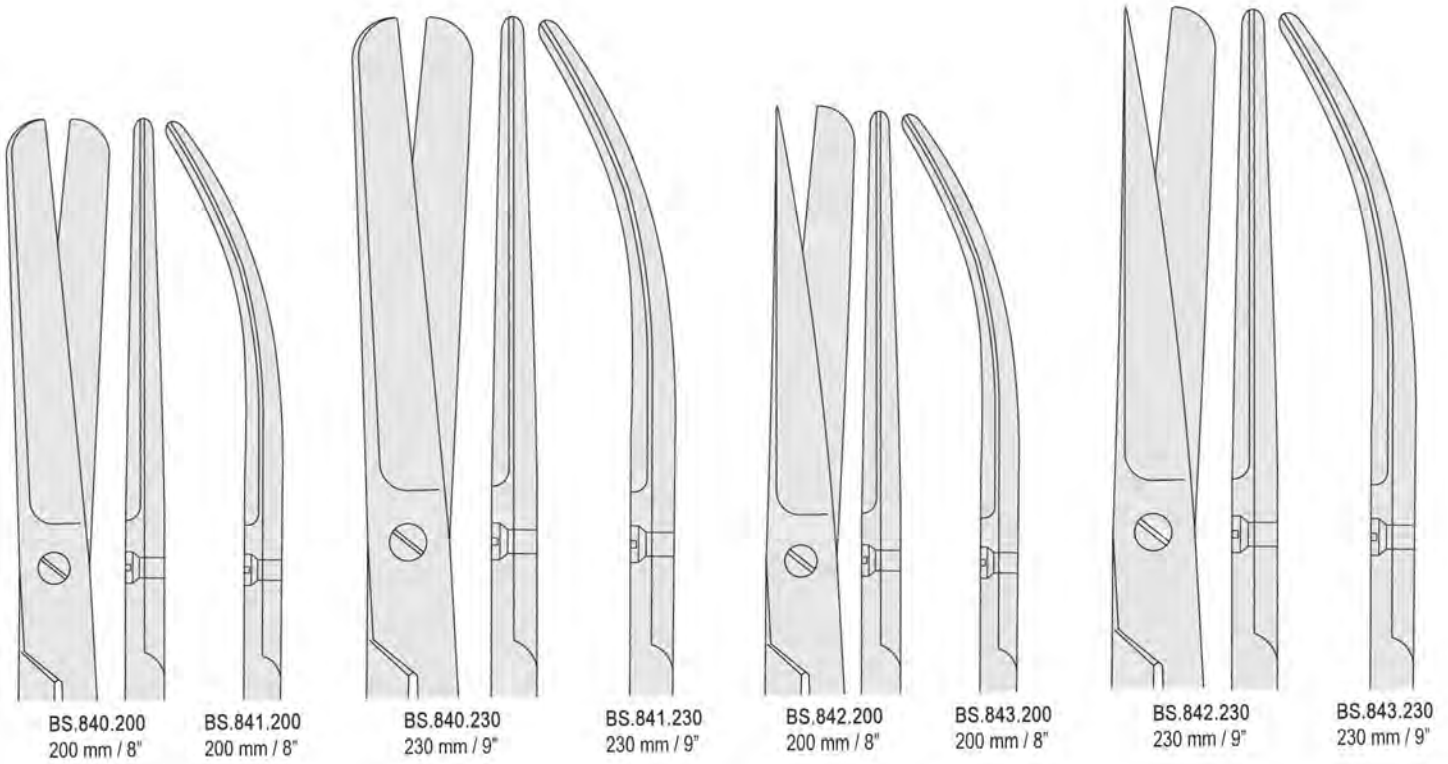

Sims





**Gynecology scissors**  
**Nożyczki ginekologiczne**



Autoclavable  
Możliwość sterylizacji w autoklawie

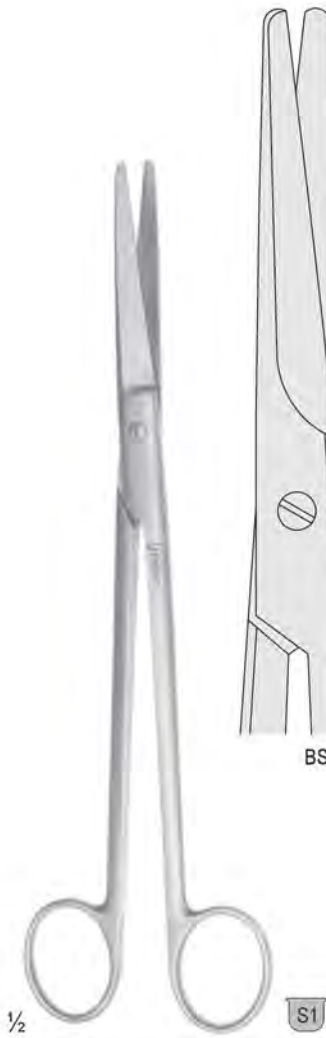

BS.814.230

**Mayo-Harrington**  
230 mm / 9"

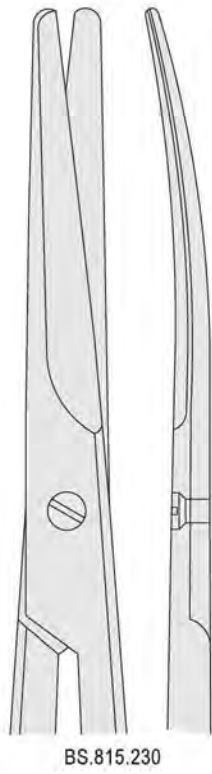

BS.815.230

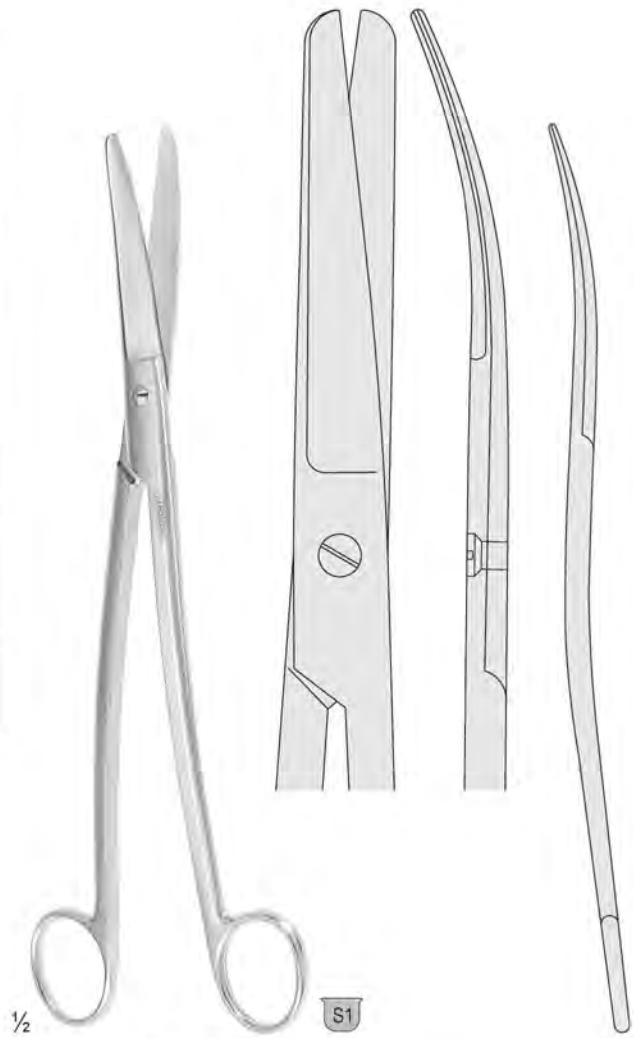

**Sims-Siebold**  
GN.435.245  
245 mm / 9 3/4"



Obstetrical scissors  
Nożyczki ginekologiczne



Autoclavable  
Możliwość sterylizacji w autoklawie

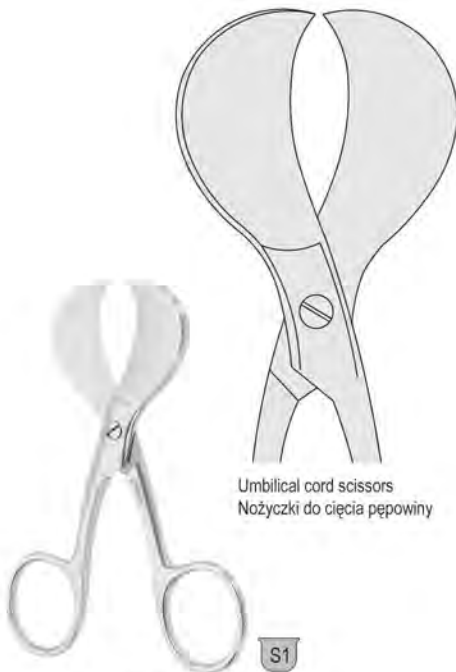

Umbilical cord scissors  
Nożyczki do cięcia pępowiny

USA-Pattern  
GO.749.105  
105 mm / 4 1/8"



Episiotomy scissors  
Nożyczki do episiotomii

Braun-Stadler  
GO.753.140 140 mm / 5 1/2"  
GO.753.220 220 mm / 8 3/4"



Lawson-Tait / Barnes  
GO.755.140  
140 mm / 5 1/2"

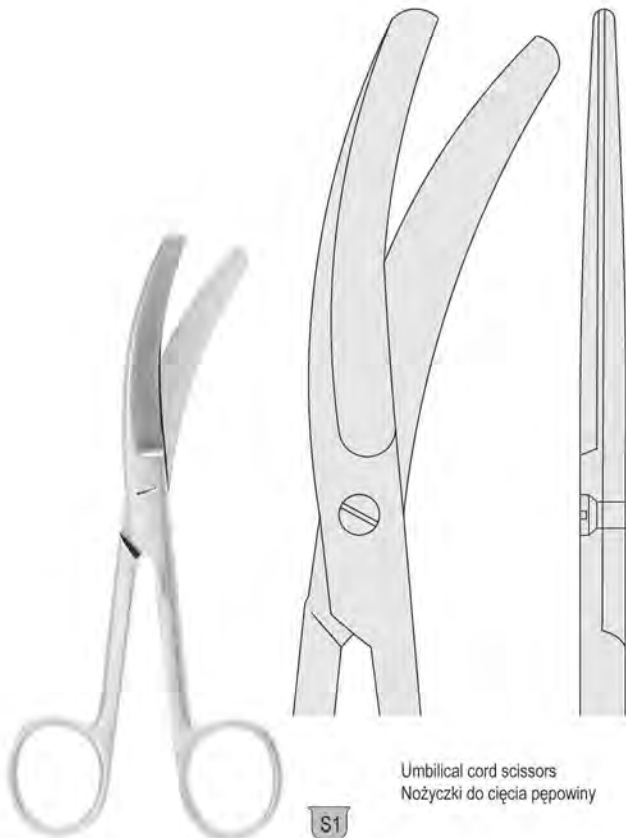

Umbilical cord scissors  
Nożyczki do cięcia pępowiny

Busch  
GO.745.160  
160 mm / 6 1/4"

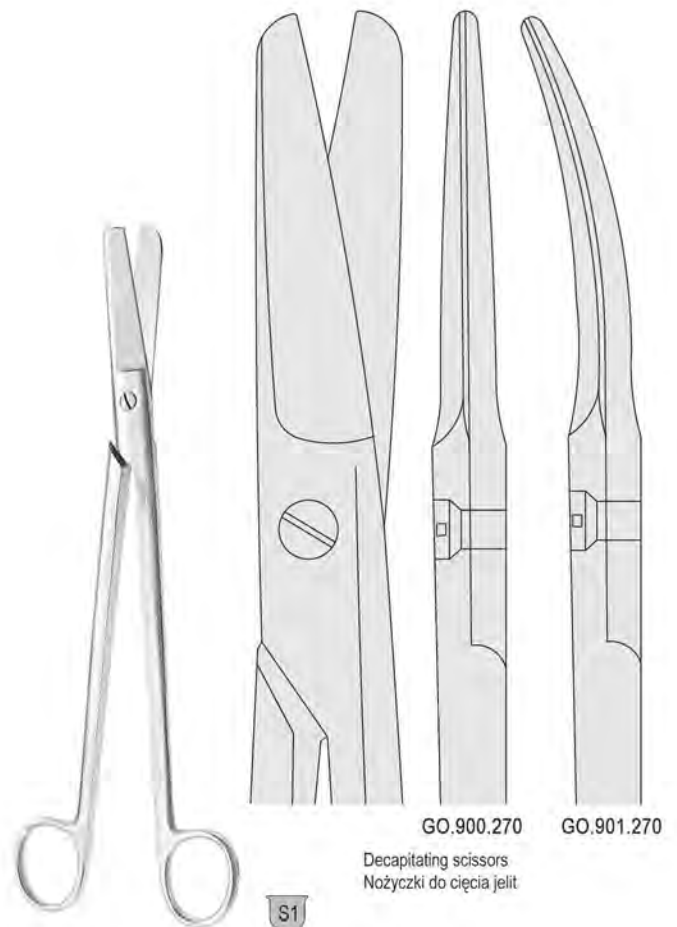

Decapitating scissors  
Nożyczki do cięcia jelit

Dubois  
270 mm / 10 3/4"



GO.900.270

GO.901.270

www.falconmedical.pl



#### **Biuro i Magazyn**

**Falcon Medical Polska sp z o.o.**  
93-575 Łódź, ul. Rembielińskiego 1/7  
Poland  
Tel: +48 42 630 99 72  
Fax: +48 42 630 99 73  
[www.falconmedical.pl](http://www.falconmedical.pl)

#### **Sklep firmowy**

**Sklep Stomatologiczno Medyczny**  
Al. Kościuszki 32, 90-419 Łódź  
Poland  
Tel: +48 42 632 20 01  
Fax: +48 42 632 20 01