

D₁

Dental Materials / Materiały stomatologiczne



PerfectAlloy
Self-Activating Capsules 40% Silver
 High Copper, non-gamma-2 alloy with
 spherical / irregular particles.

50 capsules

Size*	1 (420mg)	2 (630mg)
REF	PP010/0061	PP010/0063
Pack contains		

Perfection Plus
 Composition: Ag 40%; Sn 31%; Cu 29%
 * Spill 1 = 420mg Alloy / 400mg Hg
 * Spill 2 = 630mg Alloy / 600mg Hg
 * Spill 3 = 840mg Alloy / 800mg Hg

Distributed by:
www.perfectionplus.com
 Perfection Plus Ltd, Hants, SO46 3WX, UK

P/Plus D650
 DUOMAT 2
 Silamat S5, S6

Note: When mixing in accordance with these instructions, ensure that the amalgam is mixed without any visible unmixt alloy or mercury. The mixing should be done in the tray of your own mixer and the properties of the metal depend on the mixing technique.

Application: Start application of amalgam immediately after the mercury is added to the cavity without forcing out mercury. Condense with a condenser.

Polishing: Wait at least 24-48 hours before polishing.

Effect of mercury on metals: Mercury corrodes and causes discoloration of metals. Unnecessary contact between mercury and metal should be avoided.

Spillage: Mercury presents a health hazard if inhaled. The effect is cumulative. Spillage of mercury should be cleaned up immediately. Mercury powder is difficult to access. Use a plastic syringe to draw up the mercury. Individual seal drops are difficult to access. Individual seal drops can be removed by using a syringe. Inhalation of the vapour. During and after cleaning, the vapour should be removed.

Moisture contamination: If moisture is introduced into the amalgam, the strength and corrosion resistance can be affected. Avoid moisture contamination.

Waste Disposal: Waste material and all primary containers should be disposed of in accordance with appropriate management practice.

For dental use only.

CE 0088

CAUTION: This product contains mercury.



Gutta percha and paper points / Ćwieki gutaperkowe i papierowe

Made in Korea

DiaDent

Gutta percha points / Ćwieki gutaperkowe
Comply with ISO 6877 Standard / Zgodne z ISO 6877
Paper points / Ćwieki papierowe
Comply with ISO 7551 Standard / Zgodne z ISO 7551

Color code according to ISO Standard / Kodowanie kolorem ISO					
○ 15	● 20	● 25	● 30	● 35	● 40
45	50	55	60	70	80
90	100	110	120	130	140

Gutta percha points
Ćwieki gutaperkowe



ISO #	.02 taper odchodzeniu .02	.04 taper odchodzeniu .04	.06 taper odchodzeniu .06
10	DR.1502.10D	x	x
15	DR.1502.15D	DR.1510.15D	DR.1515.15D
20	DR.1502.20D	DR.1510.20D	DR.1515.20D
25	DR.1502.25D	DR.1510.25D	DR.1515.25D
30	DR.1502.30D	DR.1510.30D	DR.1515.30D
35	DR.1502.35D	DR.1510.35D	DR.1515.35D
40	DR.1502.40D	DR.1510.40D	DR.1515.40D
45	DR.1502.45D	DR.1510.45D	DR.1515.45D
50	DR.1502.50D	x	x
55	DR.1502.55D	x	x
60	DR.1502.60D	x	x
70	DR.1502.70D	x	x
80	DR.1502.80D	x	x
Assorted / Asortyment			
15 - 40	DR.1501.00D	DR.1510.00D	DR.1515.00D
45 - 80	DR.1501.01D	x	x

Pack of 120 pieces /
Opak. zawiera 120 szt.

Pack of 60 pieces /
Opak. zawiera 60 szt.

Pack of 60 pieces /
Opak. zawiera 60 szt.



DR.1500.00
ISO Ø 15 - 80
Assorted / Asortyment

Pack of 240 pieces
Opak. zawiera 240 szt.

Paper points
Ćwieki papierowe

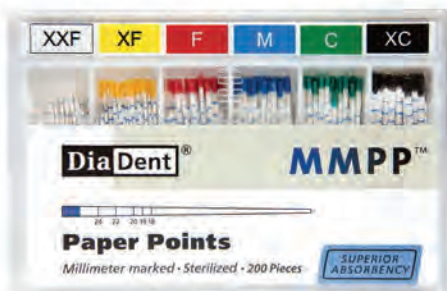

ISO #	.02 taper odchodzeniu .02	.04 taper odchodzeniu .04	.06 taper odchodzeniu .06
10	DR.1552.10D	x	x
15	DR.1552.15D	DR.1560.15D	DR.1565.15D
20	DR.1552.20D	DR.1560.20D	DR.1565.20D
25	DR.1552.25D	DR.1560.25D	DR.1565.25D
30	DR.1552.30D	DR.1560.30D	DR.1565.30D
35	DR.1552.35D	DR.1560.35D	DR.1565.35D
40	DR.1552.40D	DR.1560.40D	DR.1565.40D
45	DR.1552.45D	DR.1560.45D	DR.1565.45D
50	DR.1552.50D	x	x
55	DR.1552.55D	x	x
60	DR.1552.60D	x	x
70	DR.1552.70D	x	x
80	DR.1552.80D	x	x
Assorted / Asortyment			
15 - 40	DR.1551.00D	DR.1560.00D	DR.1565.00D
45 - 80	DR.1551.01D	x	x

Pack of 200 pieces /
Opak. zawiera 200 szt.

Pack of 100 pieces /
Opak. zawiera 100 szt.

Pack of 100 pieces /
Opak. zawiera 100 szt.



DR.1550.00
ISO Ø 15 - 80
Assorted / Asortyment

Pack of 400 pieces
Opak. zawiera 400 szt.



ProOne Gutta Percha points
ProOne Ćwieki gutaperkowe



ISO #	Ref #
F1	DR.1531.20
F2	DR.1531.25
F3	DR.1531.30
Assorted /Asortyment	
F1-F2-F3	DR.1531.00

Pack of 60 pieces / Opak. zawiera 60 szt.

ProOne Paper points
ProOne Ćwieki papierowe



ISO #	Ref #
F1	DR.1581.20
F2	DR.1581.25
F3	DR.1581.30
Assorted /Asortyment	
F1-F2-F3	DR.1581.00

Pack of 60 pieces / Opak. zawiera 100 szt.

ProNext Gutta Percha points
ProNext Ćwieki gutaperkowe



ISO #	Ref #
X1	DR.1532.01
X2	DR.1532.02
X3	DR.1532.03
Assorted /Asortyment	
X1-X2-X3	DR.1532.00

Pack of 60 pieces / Opak. zawiera 60 szt.

ProNext Paper points
ProNext Ćwieki papierowe



ISO #	Ref #
X1	DR.1582.01
X2	DR.1582.02
X3	DR.1582.03
Assorted /Asortyment	
X1-X2-X3	DR.1582.00

Pack of 60 pieces / Opak. zawiera 100 szt.

Reciproc Gutta Percha points
Reciproc Ćwieki gutaperkowe



ISO #	Ref #
R25	DR.1530.25
R40	DR.1530.40
R50	DR.1530.50
Assorted /Asortyment	
R25-R40-R50	DR.1530.00

Pack of 60 pieces / Opak. zawiera 60 szt.

Reciproc Paper points
Reciproc Ćwieki papierowe



ISO #	Ref #
R25	DR.1580.25
R40	DR.1580.40
R50	DR.1580.50
Assorted /Asortyment	
R25-R40-R50	DR.1580.00

Pack of 100 pieces / Opak. zawiera 100 szt.



Endo Irrigation needles
Igły do endoirygacji

Single side vented, 0.3 x 25 (30G x 1")
Z jednym bocznym otworem, 0.3 x 25 (30G x 1")

Double side vented, 0.3 x 25 (30G x 1")
Z dwoma bocznymi otworami, 0.3 x 25 (30G x 1")



DR.1000.01



DR.1000.02

Pack of 100 pieces, Sterile / Opak. 100 szt. Sterylny

Silicone endo stoppers
Endostopy silikonowe



Pack of 100 pieces / Opak. 100 szt

Code / Kod	Color / Kolor
DR.1001.01	White / Białe
DR.1001.02	Yellow / żółte
DR.1001.03	Red / Czerwone
DR.1001.04	Black / Czarne
DR.1001.00	Assorted / Asortyment



Pack of 50 pieces / Opak. 50 szt

Code / Kod	Color / Kolor
DR.1002.01	White / Białe
DR.1002.02	Yellow / żółte
DR.1002.03	Red / Czerwone
DR.1002.04	Black / Czarne
DR.1002.05	Blue / Niebieskie
DR.1002.06	Purple / Purpurowe
DR.1002.00	Assorted / Asortyment

Etching gel
Wytrawiacze

O-phosphoric acid 36%, gel base, dyestuff
Wytrawiacz kwaso-fosforowy 36%



DR.2000.04 2ml
Strzykawką 2 ml + zestaw aplikatorów

DR.2000.05 10ml
Strzykawką 10 ml + dozownik, łącznik, zestaw aplikatorów

DR.2000.06 50ml
Strzykawką 50 ml + zestaw dozowników, łącznik, zestaw aplikatorów

Komposite Unidose gun dispenser
Podajnik do materiałów w kapsułkach



DR.9998.01

FP-NOVOINC-150

Unidose dispenser is designed to be used to deliver composite resin restoratives and cements from unit dose tips to tooth preparations

Etching gel
Wytrawiacze

36 % phosphoric acid etching gel
Wytrawiacz kwaso-fosforowy 36%



DR.2000.01 2ml
Strzykawką 2 ml + zestaw aplikatorów

DR.2000.02 10ml
Strzykawką 10 ml + dozownik, łącznik, zestaw aplikatorów

DR.2000.03 50ml
Strzykawką 50 ml + zestaw dozowników, łącznik, zestaw aplikatorów



DR.9997.01

Pack of 100 pieces / Opak. 100 szt



Prophylaxis pastes fluoride free
Pasty polerskie bez fluoru



Propy paste cup
Pojemnik do pasty polerskiej



DZ.990.010

250 g

PP010/0051 Medium Mint / Standardowa miętowa
PP010/0052 Coarse Orange / Ostra pomarańczowa

Prophylaxis pastes
Pasty polerskie



250 g

PP010/0001 Medium Mint / Standardowa miętowa
PP010/0002 Medium Orange / Standardowa pomarańczowa
PP010/0046 Coarse Mint / Ostra miętowa
PP010/0047 Coarse Orange / Ostra pomarańczowa

Professional prophylaxis paste
Pasty polerskie



DH.5000.01
35g

Paste for cleansing crown and neck of a tooth; should be applied with prophylaxis brush or rubber polishing tips, in order to remove stains, dental plaque and debris as an alternative of sandblasting.

Professional prophylaxis paste
Pasty polerskie



DH.5000.02
35g

Paste for polishing crown and neck of a tooth, mainly after manual or ultrasonic scaling and f or polishing amalgam fillings by using rubber or silicone polishing tips. It is recommended to cleanse teeth with CHEMA POLISH I paste before polishing

GC MI Paste Plus
Pasta do zębów GC MI Paste Plus z fluorem



40 g

Code / Kod	Taste / Smak
DH.3501.01	Melon / Melon
DH.3501.02	Mint / Mięta
DH.3501.03	Strawberry / Truskawka
DH.3501.04	Tutti frutti / Tutti frutti
DH.3501.05	Vanila / Wanilia

GC Tooth Mousse
Pasta do zębów GC Tooth Mousse



40 g

Code / Kod	Taste / Smak
DH.3500.01	Melon / Melon
DH.3500.02	Mint / Mięta
DH.3500.03	Strawberry / Truskawka
DH.3500.04	Tutti frutti / Tutti frutti
DH.3500.05	Vanila / Wanilia



Whitening Toothpaste
Wybielająca pasta do zębów

Opalescence Whitening Original Toothpaste
Fluoride Cool Mint Z fluorem smak miętowy



DH.3000.12 133g

Opalescence

Opalescence Whitening Sensitivity Toothpaste
Pasta do nadwrażliwych zębów - Opalescence Sensitivity Relief



DH.3000.32 133g

Opalescence Go 6% PF
Opalescence Go 6% Napelnione nakładki wybielające

Każdy zestaw zawiera 10 opakowań blistrowych po 1 nakładce górnej / 1 nakładce dolnej



UP 3593
Melon (arbuzowy)

UP 4634
Mint (miętowy)

Opalescence carbamide peroxide teeth whitening bleaching gel
Opalescence PF10% Żel do wybielania zębów

1.2ml (2 syringes) / 1.2ml (Opak 2 strzykawki)



UP 5395
Melon (arbuzowy)

UP 5396
Regular (klasyczny)

UP 5394
Mint (miętowy)

Opalescence carbamide peroxide teeth whitening bleaching gel
Opalescence PF16% Żel do wybielania zębów

1.2ml (2 syringes) / 1.2ml (Opak 2 strzykawki)



6 UP 4487
Melon (arbuzowy)

UP 4488
Regular (klasyczny)

UP 4486
Mint (miętowy)

Opalescence Boost PF 40%
Opalescence Boost PF 40%



UP 4750
Opalescence Boost PF 40% Intro Kit
4 x 1,2 ml (1,49 g) Opalescence Boost /Activator syringes
2 x 1,2 ml (1,34 g) OpalDam Green syringes
2 x IsoBlocks
2 x Shade guide cards
2 x Ultradent Luer Vacuum Adapters
2 x SST - Surgical Suction Tip
10 x Micro 20 ga Tips
10 x Micro 20 ga FX Tips

UP 4751
Opalescence Boost PF 40% Patient Kit
2 x 1,2 ml (1,49 g) Opalescence Boost /Activator syringes
1 x 1,2 ml (1,34 g) OpalDam Green syringe
1 x IsoBlock
1 x Shade guide card
5 x Micro 20 ga Tips
5 x Micro 20 ga FX Tips



Articulating papers / Kalki artykulacyjne



Blue / Niebieska
PP002/0006
71 microns
o grubości 71 mikronów
12 x 12 sheets / 12 x 12 kartek

Horseshoe, Red-Blue
Podkowiasta, niebiesko- czerwona



PP002/0004
71 microns
o grubości 71 mikronów
6 x 12 sheet / 6 x 12 kartek

Red-Blue
Niebiesko-czerwona
PP002/0005
63 microns
o grubości 63 mikronów
12 x 12 sheets / 12 x 12 kartek



Blue / Niebieska
PP002/0007
79 microns
o grubości 79 mikronów
12 x 12 sheets / 12 x 12 kartek



Mouthwash tablets
Tabletki do płukania jamy ustnej



Pack of 1000 pieces / Opak. 1000 szt.

PP010/0043 Thymol / tymol
PP010/0044 Mint / miętowe
PP010/0045 Orange / pomarańczowe

A mildly antiseptic mouth gargle and mouth rinse for use after and during dental treatment

Środek antyseptyczny do płukania jamy ustnej stosowany w trakcie i po leczeniu.

Gingival retraction cords / Nici retrakcyjne

Polyester-polyamide, impregnated with aluminium chloride
Poliestrowo-poliamidowe, nasączone chlorkiem glinu



Made in Korea

254cm Length / Długość



Code / Kod Size / Rozmiar

DI.1200.00	000
DI.1200.01	00
DI.1200.02	0
DI.1200.03	1
DI.1200.04	2

Interdental transparent wedges
Kliny międzyzębowe

Pack of 100 pieces / Opak. zawiera 100 szt.

Code / Kod	Size / Rozmiar
20-1091	Ultra-Slim / Bardzo wąskie
20-1092	Slim / Wąskie
20-1093	Medium / Średnie
20-1094	Large / Szerokie



Polyester tooth forms
Formówka Białostocka



DR.811.070

Białostocka polyester tooth forms front (1-3) 160 pcs
Formówka Białostocka kształtów zębów przednich (1-3) 160 sztuk

Interdental wedge with Guard
Kliny z blaszką - WedgeGuard

WedgeGuard prevents the bur from nicking the adjacent tooth. And uniquely, after tooth preparation, the guard is detached while the wedge remains in place.

Prevents bur damage to adjacent tooth
Saves time and protects gingival papillae

Pack of 50 pieces / Opak. zawiera 50 szt.

Code / Kod	Size / Rozmiar	Color / Kolor
DR.8000.01	Small / Małe	Green / Zielone
DR.8000.02	Medium / Średnie	Orange / Pomarańczowe
DR.8000.03	Large / Duże	Purple / Fioletowe





Interdental plastic wedge with hole
Kliny plastikowe z dziurą



Pack of 100 pieces / Opak. zawiera 100 szt.

Code / Kod	Size / Rozmiar
DR.8001.01	X Small / X-Male
DR.8001.02	Small / Małe
DR.8001.03	Medium / Średnie
DR.8001.04	Large / Duże

Interdental plastic wedge with handle
Kliny z uchwytem



Pack of 100 pieces / Opak. zawiera 100 szt.

Code / Kod	Size / Rozmiar
DR.8002.01	Small / Małe
DR.8002.02	Medium / Średnie
DR.8002.03	Large / Duże

Alginate / Alginaty



DI.1000.01
453g



DI.1000.03
453g



DI.1000.04
453g



DI.1000.09
450g



DI.1000.05
453g



DI.1000.02
453g

Dental modeling wax / Wosk modelowy



DL.2000.03
Hard / Twardy
500g



DL.2000.04
Soft / Miękki
500g



DL.2000.05
Hard S / Twardy S
500g



Wosk modelowy w postaci płyt barwy ciemnoróżowej. Pojedyncza płyta służy do stosowania u jednego pacjenta.



Wosk modelowy w postaci płyt barwy jasnoróżowej. Pojedyncza płyta służy do stosowania u jednego pacjenta.



Wosk modelowy w postaci płyt barwy różowej. Pojedyncza płyta służy do stosowania u jednego pacjenta.

D₂

Disposable Products / Produkty jednorazowe





Disposable Products
Produkty jednorazowe

Finesoft Nitrile gloves powder free
Finesoft Rękawiczki nitylowe bezpudrowe

Glove Type 2.5 mils
Weight Ref M = 3.5g ± 0.2g



EN ISO 374-1/Type B EN ISO 374-5:2016



XS	S	M	L
75 ± 5 mm	85 ± 5 mm	95 ± 5 mm	106 ± 5 mm

Textured fingertips Textured fingertips Textured fingertips



X-Small	GL200XS
Small	GL200S
Medium	GL200M
Large	GL200L

Box of 100 gloves / Opak. 100 szt.

X-Small	GL203XS
Small	GL203S
Medium	GL203M
Large	GL203L

Box of 100 gloves / Opak. 100 szt.

X-Small	GL204XS
Small	GL204S
Medium	GL204M

Box of 100 gloves / Opak. 100 szt.

Surgical face masks
Maski chirurgiczne

Type IIR Mask

to protect the patient as well as the healthcare provider against splashes of potentially contaminated liquids

3ply surgical face mask-ear loop

Structure	1st ply	Material	White general nonwoven
		Weight	25 (+/-)2) gsm
	2nd ply	Material	White general filter paper
		Weight	25 (+/-)2) gsm
	3rd ply	Material	White general nonwoven
		Weight	25 (+/-)2) gsm
Loop	Spandex and polyester blended yarn		
Nose bar	White plastic wrapped metal nose bar		
Composition	Polypropylene fibre 98%, polyester fibre 2%		
Performance	BFE 98%, PFE 99%, Delta P=2.7MM H2O/CM2/Polypropylene		



DZ.2020.01
Blue with shield
Niebieskie z osłoną na oczy
Pack of 25 pieces
Opak. 25 szt.



DZ.2000.01
Blue / Niebieskie
Pack of 50 pieces
Opak. 50 szt.



DZ.2000.04
Black / Czarne
Pack of 50 pieces
Opak. 50 szt.





Face masks earloop FFP2 / KN95
Maska ochronna FFP2 / KN95



DZ.2010.01
 Pack of 10 pcs
 Opak 10 szt.

FFP2 / KN95 (China GB2626-2006) / EN149:2001 + A1:2009
 Particulate filtration efficiency ≥ 95%
 Quality in accordance with CE and ISO13485 standards

Bouffant caps
Czepki ochronne



DZ.2300.01 White / Białe
 DZ.2300.02 Blue / Niebieskie
 DZ.2300.03 Green / Zielone

Size / Rozmiar
 53 cm



Pack of 100 pieces / Opak. 100 szt



Plastic shoe covers, anti slip
Ochraniacze na buty, antypoślizgowe



DZ.2400.01 Regular blue / Uniwersalne niebieskie
 Pack of 100 pieces / Opak. 100 szt

Steam sterilization indicator strips
Paski do kontroli sterylizacji



DZ.0111.00
 Pack of 500 pieces / Opak 500 szt.

Face mask dispenser with cover
Pojemnik na maski chirurgiczne



DZ.2000.00
 108 x 193 x 108mm

Dental bibs 2-ply paper + 1-ply poly
Serwety stomatologiczne

330 mm x 455 mm
 Pack of 500 pieces / Opak. 500 szt



DZ.2502.01
 Lavender / Lawendowe

DZ.2502.02
 Blue / Niebieskie

DZ.2502.03
 White / Białe

DZ.2502.04
 Yellow / Żółte

DZ.2502.05
 Green / Zielone

DZ.2502.06
 Dusty rose / Brudny róż

DZ.2502.07
 Peach / Brzoskwińowe

DZ.2502.08
 Aqua / Morskie

DZ.2502.09
 Dark blue / Granatowe

DZ.2502.10
 Orange / Pomarańczowe

DZ.2502.11
 Black / Czarne

DZ.2502.12
 Burgundy / burgundowe

DZ.2502.13
 Fuchsia / Ciemnoróżowe

Biological test for steam sterilization
Biologiczny test do steryl. para wodną



DZ.0112.00
 Pack of 10 pieces / Opak 10 szt.

Dental bibs 2-ply paper + 1-ply poly
Serwety stomatologiczne



DENTALINE®
 DZ.2500.01 Blue / niebieskie
 DZ.2500.02 Green / zielone
 DZ.2500.04 White / białe
 Pack of 100 pieces / Opak. 100 szt.
 330 mm x 460 mm

Sterilization rolls
Rękawy do sterylizacji



Length / Długość 200 m

Code / Kod	Width / Szerokość
DZ.0200.00	50mm
DZ.0210.00	75mm
DZ.0220.00	100mm
DZ.0230.00	150mm
DZ.0240.00	200mm
DZ.0250.00	250mm



Sterilization pouches
Torebki do sterylizacji

Medical grade paper is available in both 60 and 70gsm
Film is available with tinted-blue standard film and tinted-green non-tearing film
Products are available with 60gsm medical paper, 52um tinted-blue standard film and 70gsm medical paper, 52um tinted-green non-tearing film
With 2 indicators for steam and EO, gas sterilization

Features:

Non-tearing film: a superior film to avoid tearing at any opening conditions
Multi-sealing lines: to reduce fiber peel and to minimize the risk of damage of sealing-integrity while loading, stocking and transportation
Free-polluted printing: printing is placed at the sealing areas with water-based ink to avoid contaminating packed items during sterilization
Formaldehyde indicator is available upon request
OEM and ODM for tailor-made sterilization packing are welcome
Standards: EN 868, ISO 11607 and 11140

Code / Kod	Size / Rozmiar
DZ.0110.00	57 x 70 mm
DZ.0110.01	57 x 105 mm
DZ.0110.02	70 x 230 mm
DZ.0110.03	90 x 135 mm
DZ.0110.04	90 x 230 mm
DZ.0110.05	100 x 230 mm
DZ.0110.06	135 x 255 mm
DZ.0110.07	190 x 330 mm
DZ.0110.08	200 x 330 mm



Pack of 200 pieces / Opak. 200 szt.

Barrier film dispenser
Stojak na taśmę

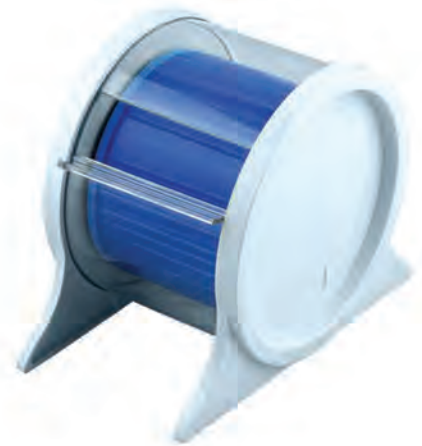

DZ.0500.00

Biodegradable paper cups
Jednorazowe kubki papierowe

Capacity / Pojemność 5 oz / 150 ml
Pack of 50 pieces / Opak. 50 szt.



DZ.3068.01

Disposable dappen dishes
Jednorazowe kieliszki



DZ.8500.02 Light blue / Jasnyniebieskie
DZ.8500.04 White / Białe
DZ.8500.05 Yellow / Żółte
DZ.8500.06 Lavender / Lawendowe
Pack of 100 pieces / Opak. 100 szt.

DZ.8500.01 Green / Zielone
DZ.8500.03 Pink / Różowe
DZ.8500.07 Blue / Niebieskie
DZ.8500.08 Black / Czarne
Pack of 100 pieces / Opak. 100 szt.

DENTALINE®
Disposable barrier film
Samoprzylepna taśma ochronna

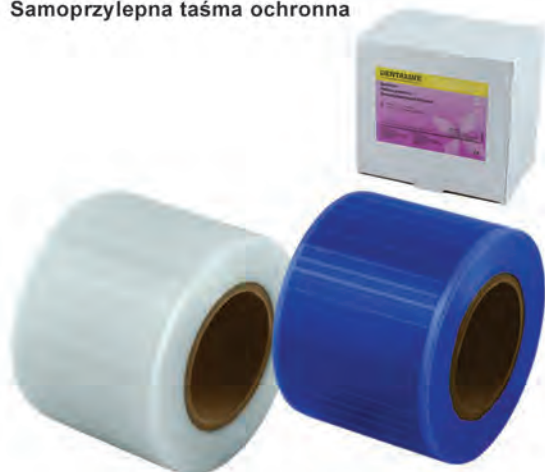

DZ.0500.01 Blue / Niebieska
DZ.0500.02 Clear / Przezroczysta
100 x 150mm
Roll of 1200 sheets / Opak. 1200 szt.

DENTALINE®
Disposable full chair cover
Jednorazowy pokrowiec na fotel



DZ.0530.00
73 x 200 cm
Pack of 125 pieces / Opak. 125 szt.



Disposable headrest cover
Jednorazowy pokrowiec na zagłówek



DZ.0510.00
280 x 240 x 50mm
Pack of 250 pieces / Opak. 250 szt.

Disposable half chair cover
Jednorazowy pokrowiec na fotel



DZ.0520.00
69 x 60 cm
Pack of 225 pieces / Opak. 225 szt.

DENTALINE®
Pre-Cut sleeves / Jednorazowe pokrowce

For protection of handpieces,
air water syringes and curing lights,
available in two sizes

Pokrowce ochronne do końcówek turbin,
dmuchawek wodnych oraz końcówek światłoutwardzalnych.
Dostępne w dwóch rozmiarach

Pack of 500 pieces / Opak. 500 szt.



DZ.0508.01
25 x 200mm



DZ.0508.03
60 x 250mm

DENTALINE®
Pre-cut sleeves for low speed handpieces
Jednorazowe pokrowce na kątnice

Pack of 500 pieces / Opak. 500 szt.



DZ.0508.04
38 x 200mm

DENTALINE®
Pre-cut sleeves for curing light
Jednorazowe pokrowce na lampy polimeryzacyjne

Pack of 500 pieces / Opak. 500 szt.



DZ.0508.07
84 x 320 mm

DENTALINE®
Pre-cut sleeves for trays
Jednorazowe pokrowce na tacki

Pack of 500 pieces / Opak. 500 szt.



DZ.0508.05
295 x 405 mm

DENTALINE®
Pre-cut sleeves for Intra-oral Camera
Jednorazowe pokrowce na kamery wewnętrzne

Pack of 100 pieces / Opak. 100 szt.



DENTALINE®
Pre-cut sleeves for scaler handpieces
Jednorazowe pokrowce na rękojeści do skalera

Pack of 500 pieces / Opak. 500 szt.



DZ.0508.06
40 x 200 mm

DENTALINE®
Pre-cut sleeves for syringes
Jednorazowe pokrowce na strzykawkę

Pack of 500 pieces / Opak. 500 szt.



DZ.0508.09
64 x 250 mm



Disposable Products
Produkty jednorazowe

DENTALINE®

Pre-cut sleeves for digital x ray sensor
Jednorazowe pokrowce na cyfrowe czujniki RTG

Pack of 500 pieces / Opak. 500 szt.



DZ.0508.10
64 x 250 mm

DENTALINE®

Disposable syringe tip covers
Jednorazowe osłonki do dmuchawek

- Ideal for infection control
- Slides over 3-1 syringe tips
- Doskonałe do kontroli zakażeń
- Model uniwersalny do wszystkich typów dmuchawek



DZ.0505.03
Pack of 50 pieces / Opak. 50 szt.

DZ.0505.04
Pack of 50 pieces / Opak. 50 szt.

INJEKT Luer Solo 2-piece disposable syringes
INJEKT strzykawka 2-częściowa, luer

STERILE



4606027V 2ml
4606051V 5ml
4606108V 10ml
4606205V 20ml

Pack of 100 pieces / Opak. 100 szt.

Disposable dental needles
Jednorazowe igły stomatologiczne

Sterile, thread in compliance with European standard
Sterylnie, gwint w zgodności z europejskim standardem
do strzykawek typu karpula

DA.1000.12 0,3 x 12 mm
DA.1000.16 0,3 x 16 mm
DA.1000.21 0,3 x 21 mm
DA.1000.25 0,3 x 25 mm
DA.1001.25 0,4 x 25 mm
DA.1001.36 0,3 x 36 mm



Pack of 100 pieces / Opak. 100 szt.

DENTALINE®

Cotton rolls / Wateczki bawełniane



DZ.6000.01 Fig. 1 8 x 38 mm
DZ.6000.02 Fig. 2 10 x 38 mm
Pack of 500 pieces / Opak. 500 szt.

Cellulose wadding pads
Lignina, wata celulozowa

Kompresy z celulozy PAD 8-warstwowe,
niejałowe, 4cm x 5cm -2 rolki x 500szt.



DZ.6001.01
2 x 500 pcs / szt

Cellulose wadding pads
Lignina, wata celulozowa



DZ.6001.02
150 g.

Gauze swabs (Non-sterile)
Kompresey z gazy (Niejałowe)



Pack of 100 pieces / Opak. 100 szt.

8-ply / 13-nitkowe, 8-warstwowe
MA-101-A100-011 50 x 50 mm
MA-101-A100-012 75 x 75 mm

8-ply / 17-nitkowe, 8-warstwowe
MA-103-A100-001 50 x 50 mm
MA-101-A100-003 100 x 100 mm





Gauze swabs (Sterile)
Komprese z gazy (Jałowe)

STERILE



12-ply / 17-nitkowe, 12-warstwowe
MA-102-PS03-004 50 x 50 mm
MA-102-PS03-005 75 x 75 mm

8-ply / 17-nitkowe, 8-warstwowe
MA-102-PS03-003 90 x 90 mm

Pack of 3 pieces / Opak. 3 szt.

Gauze sponge dispenser
Pojemnik na kompresy



Autoclavable
Możliwość sterylizacji w autoklawie



PP0020044
50 x 50mm

Disposable surgical gowns
Jednorazowe fartuchy ochronne



DZ.2200.01
Universal size
Rozmiar uniwersalny



DZ.2200.02
Universal size
Rozmiar uniwersalny



DZ.2200.03
Universal size
Rozmiar uniwersalny

Made from non-woven material with PE (Polyethylene) film, Fluid resistant gown features elastic cuffs with waist and neck tie closures Comfortable and lightweight, Breathable, Economical and disposable, One size fits all, For hospitals, laboratories, clinics, trauma centers, burn units and critical care units

Fartuchy ochronne z certyfikowanej włókniny typu spunbond 30 gr/m2, Certyfikat oekotex standard 100
Oraz atest PZH, Troczki do Wiązania na karku oraz w pasie, gumki w rękawach

Disposable plastic cups
Jednorazowe kubki plastikowe

Capacity / Pojemność 180 ml
Pack of 100 pieces / Opak. 100 szt.



DZ.3067.01 Orange / Pomarańczowe
DZ.3067.02 Lavender / Lawendowe
DZ.3067.03 Light blue / Jasnoniebieskie
DZ.3067.04 White / Białe
DZ.3067.05 Yellow / Żółte

DZ.3067.06 Green / Zielone
DZ.3067.07 Pink / Różowe
DZ.3067.08 Dark blue / Granatowe
DZ.3067.09 Red / Czerwone

Multi-purpose disposable instruments set
Wielofunkcyjny jednorazowy zestaw instrumentów

STERILE R 25KGy Gamma Radiation - Sterilized

Benefits / Zalety:

Ready to Use:
Minimizes tray set-up time
Gotowy do użycia:
Minimalizuje czas przygotowań

Hygienic:
Eliminate cross contamination issues
Higieniczny:
Wyklucza możliwość zakażeń

Convenient:
For routine use, in case of staff shortages, autoclave breakdowns, home visits and for high risk patients.

Wygodny:
Do codziennego użytku, awarii autoklawu, wizyt domowych, braków w wyposażeniu oraz pacjentów wysokiego ryzyka.

Time saving
Reduces time spent sterilizing.
Oszczędność czasu:
Oszczędza czas poświęcony sterylizacji

Cost effective
Increase productivity and reduce cost of sterilization.
Oszczędność kosztów:
Zwiększa produktywność i obniża koszty sterylizacji



DX.001.010

Contents:

- 1 x Explorer with plastic filling instrument
- 1 x Tweezers with plastic filling Instrument
- 1 x Mirror and plastic spatula
- 1 x Patient bib
- 1 x Saliva Ejector
- 2 x Cotton rolls
- 1 x Tray

Zawiera:

- 1 x Zgłębnik z nakładaczem
- 1 x Pensetę z nakładaczem
- 1 x Lusterko z plastikową łopatką
- 1 x Serwetę
- 1 x Ślinociąg
- 2 x Waleczki bawełniane
- 1 x Tackę



Disposable Products
Produkty jednorazowe

Disposable mixing wells
Jednorazowe podstawki do mieszania



DZ.457.010
Pack of 100 pieces / Opak. 100 szt.

Mixing pads
Bloczki papierowe do mieszania



DZ.458.010 50 x 50 mm
DZ.458.020 75 x 75 mm
DZ.458.030 75 x 125 mm
DZ.458.040 100 x 140 mm
DZ.458.050 140 x 180 mm
50 sheets / 50 kartek

Disposable mixing spatulae
Jednorazowe łopatkki do mieszania



DR.997.020
Pack of 200 pieces
Opak. 200 szt.

DENTALINE®
Disposable instrument trays
Tacki jednorazowe



DZ.455.010B White
DZ.455.010O Orange
DZ.455.010A Light blue
DZ.455.010G Yellow
DZ.455.010L Violet
DZ.455.010V Green

284 x 183 x 17mm
Pack of 400 pieces / Opak. 400 szt.



DZ.456.010
183 x 140 x 17mm
Pack of 100 pieces / Opak. 100 szt.

Micro applicators
Aplikatory mikro

Pack of 100 pieces
Opak. 100 szt.

Made in Germany



DZ.8625.01



DZ.8625.02



DZ.8625.04



DZ.8625.05

Micro applicators set
Zestaw aplikatorów



DZ.8625.00
Pack of 400 pieces
Opak. 400 szt.

Bond brushes micro
Pędzelki do bondingu mikro

Pack of 100 pieces
Opak. 100 szt.

Made in Germany



DZ.8610.01



DZ.8610.02



DZ.8610.03



DZ.8610.04

Bond brushes standard
Pędzelki do bondingu standardowe

Pack of 100 pieces
Opak. 100 szt.

Made in Germany



DZ.8611.01



DZ.8611.02



DENTALINE®

Micro applicators / Aplikatory mikro

Pack of 100 pieces
 Opak, 100 szt.



Ultra-Fine DZ.8619.05 White / Białe	Fine DZ.8620.01 Blue / Niebieskie	Fine DZ.8620.02 Green / Zielone	Fine DZ.8620.03 Pink / Różowe	Fine DZ.8620.04 Yellow / Żółte	Regular DZ.8621.06 Orange / pomarańczowe
---	---	---------------------------------------	-------------------------------------	--------------------------------------	--

Bond brushes
Pędzelki do bondingu

Pack of 100 pieces
 Opak. 100 szt.

Made in Germany

Bond brushes set
Zestaw pędzelków

- DZ.8600.01
Blue / Niebieskie
- DZ.8600.02
Green / Zielone
- DZ.8600.03
Red / Czerwone
- DZ.8600.04
Yellow / Żółte



DZ.8600.00
 Pack of 400 pieces
 Opak. 400 szt.

Brush handle / Uchwyt do pędzelków

Made in Germany



DZ.8612.00
 Pack of 3 pieces
 Opak. 3 szt.

Disposable evacuator tips
Jednorazowy łącznik do końcówek ssących

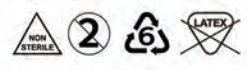
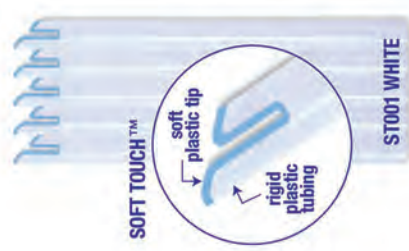

DZ.5015.05
 Pack of 50 pieces
 Opak, 50 szt.

Disposable evacuator tips vented 'S'
Jednorazowy łącznik do końcówek ssących

DENTALINE®

Pack of 100 pieces
 Opak. 100 szt.

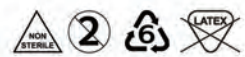

DZ.5015.01 Blue / Niebieski
 DZ.5015.04 White / Biały

Ø 11 mm

Disposable surgical aspirating tips
Jednorazowe końcówki ssące

DENTALINE®

Pack of 20 pieces
 Opak. 20 szt.

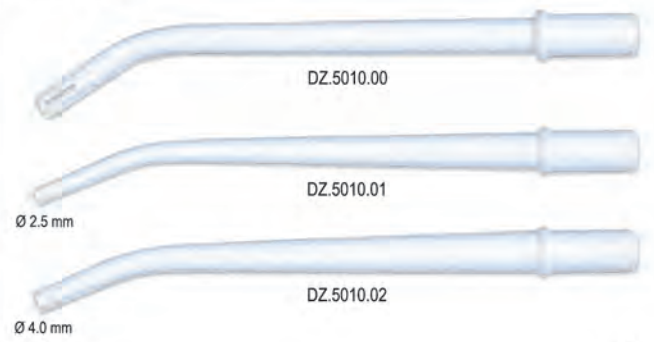

DZ.5010.00

DZ.5010.01

DZ.5010.02



Disposable Products
Produkty jednorazowe

Disposable surgical aspirating tips
Jednorazowe końcówki ssące



DZ.5011.02
Pack of 25 pieces
Opak. 25 szt

Ø 1.2 mm



DZ.5011.04
Pack of 25 pieces
Opak. 25 szt

Ø 2.5 mm

Adaptor for surgical aspirator tips
Podwójny adapter do końcówek

11mm / 16mm + 6.5mm / 11mm



DZ.5012.00
Pair / para

Flowable composite and etching gel tips
Igły do aplikacji

DENTALINE®

23G, 0.6mm

23G, 0.6mm

20G, 0.9 mm

18G, 1.2 mm



DR.9980.01
100 pieces / 100 szt

DR.9981.01
25 pieces / 25 szt.

DR.9980.02
100 pieces / 100 szt

DR.9980.03
100 pieces / 100 szt

Disposable dental mirror plain with handle
Jednorazowe lustro płaskie z uchwytem

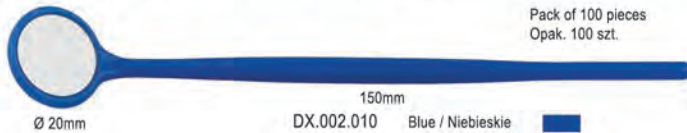

Pack of 100 pieces
Opak. 100 szt.

Ø 20mm

150mm

- | | | |
|------------|--------------------|--|
| DX.002.010 | Blue / Niebieskie | |
| DX.002.020 | Red / Czerwone | |
| DX.002.030 | Green / Zielone | |
| DX.002.040 | Purple / Purpurowe | |

Micro applicators / Aplikatory mikro



DZ.8617.00
Dispenser / Dozownik

Disposable endodontic plastic syringe tips
Jednorazowe końcówki endodontyczne do strzykawki

Pack of 20 pieces
Opak.20 szt



DR.9800.01
Luer lock



DR.9800.02
Luer lock

Disposable medical waste bags
Worki na odpady medyczne



DZ.1201.35
35 Litre
Pack of 50 pieces
Opak.50 szt

DZ.1201.60
60 Litre
Pack of 50 pieces
Opak.50 szt

DZ.1201.120
120 Litre
Pack of 50 pieces
Opak.50 szt

Disposable medical waste container
Pojemnik na odpady medyczne



DZ.1200.04
0.7 L



DZ.1200.05
1.0 L



DZ.1200.10
2.0 L



DZ.1200.06
3.0 L



DZ.1200.07
5.0 L



DZ.1200.09
10.0 L



Saliva ejectors
Ślinociągi



Removable clear tip

Zdejmowana końcówka przezroczysta

Pack of 100 pieces / Opak. 100 szt.

Length 130mm Długość 130mm	Length 150mm Długość 150mm	Color Kolor
DZ.3400.00	DZ.3401.00	Clear / Przezroczyste
DZ.3400.01	DZ.3401.01	Blue / Niebieskie
DZ.3400.02	DZ.3401.02	Green / Zielone
DZ.3400.03	DZ.3401.03	Yellow / Żółte
DZ.3400.04	DZ.3401.04	Red / Czerwone
DZ.3400.05	DZ.3401.05	Orange / Pomarańczowe
DZ.3400.06	DZ.3401.06	Pink / Różowe
DZ.3400.07	x	Fuchsia / Fuksje
x	DZ.3401.08	Lavender / Lawendowe

Oral evacuator tips

Wielorazowe końcówki do ssaka

Pack of 50 pieces / Opak. 50 szt.



DZ.5016.01
16mm x 150mm



DZ.5016.00
16mm x 120mm

Disposable non woven spittoon filters
Jednorazowe wkłady do spluwaczki



Pack of 50 pieces
Opak. 50 szt

DZ.6100.01	yellow / żółte
DZ.6100.02	salmon / lososiowe
DZ.6100.03	light blue / jasnoniebieskie
DZ.6100.04	dark blue / ciemnoniebieskie
DZ.6100.05	green / zielone
DZ.6100.06	white / białe
DZ.6100.07	purple / fioletowe
DZ.6100.08	light green / jasnozielone
DZ.6100.09	lavender / lawendowe
DZ.6100.10	pink / różowe
DZ.6100.11	lime / limonka

Disposable prepasted toothbrushes
Szczoteczki jednorazowe z pastą

Prepasted with mint tooth paste
 Perfect for patients use prior to treatment

Pasta o smaku miętowym
 Doskonałe w sytuacjach awaryjnych

Pack of 144 pieces, assorted colors
 Opak. zawiera 144 szt, asortyment



DH.2090.00

Disposable fluoride foam trays
Jednorazowe łyżki do fluoryzacji

DENTALINE®

Pack of 100 pairs
 Opak. zawiera 100 par

DH.6000.01	Small green / Małe zielone
DH.6000.02	Medium yellow / Średnie żółte
DH.6000.03	Large blue / Duże niebieskie





Disposable Products Produkty jednorazowe

Disposable 3-1 Air water syringe tips Jednorazowe końcówki do dmuchawek

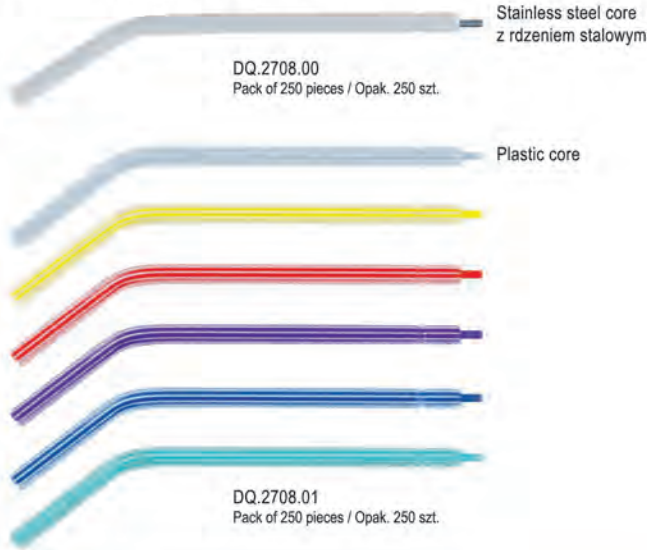

Latex rubber dam Koferdam z lateksu



Refill face shields Szybki wymienne do przyłbic



Disposable protective face shield Jednorazowa przyłbica ochronna



FACE VISOR - Disposable face shields PRZYŁBICA OCHRONNA - Jednorazowe osłony foliowe antystatyczne

- High clarity polycarbonate shields
- Shaped for improved ventilation and maximum coverage
- Protective film on both sides
- Scratch resistant
- Latex free

- Wysoka przejrzystość, wykonane z poliwęglanu
- Wyprofilowane dla lepszej wentylacji i pełnego zakrycia twarzy
- Folia ochronna po obu stronach
- Odporne na zarysowania
- Nie zawierają lateksu

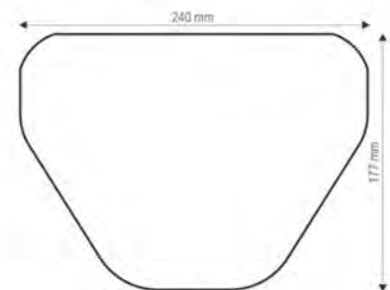

DZ.9010.12
Pack of 12 pieces
Opak. 12 szt

FACE VISOR - Disposable face shields PRZYŁBICA OCHRONNA - Jednorazowe osłony foliowe antystatyczne

- High clarity polycarbonate shields
- Shaped for improved ventilation and maximum coverage
- Protective film on both sides
- Scratch resistant
- Latex free

- Wysoka przejrzystość, wykonane z poliwęglanu
- Wyprofilowane dla lepszej wentylacji i pełnego zakrycia twarzy
- Folia ochronna po obu stronach
- Odporne na zarysowania
- Nie zawierają lateksu

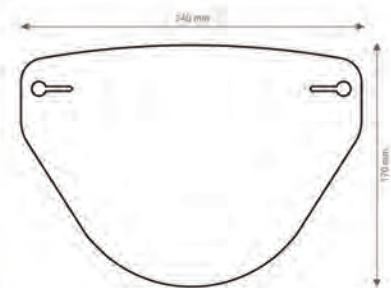

DZ.9011.12
Pack of 12 pieces
Opak. 12 szt

D₃

Dental Equipment / Sprzęt stomatologiczny

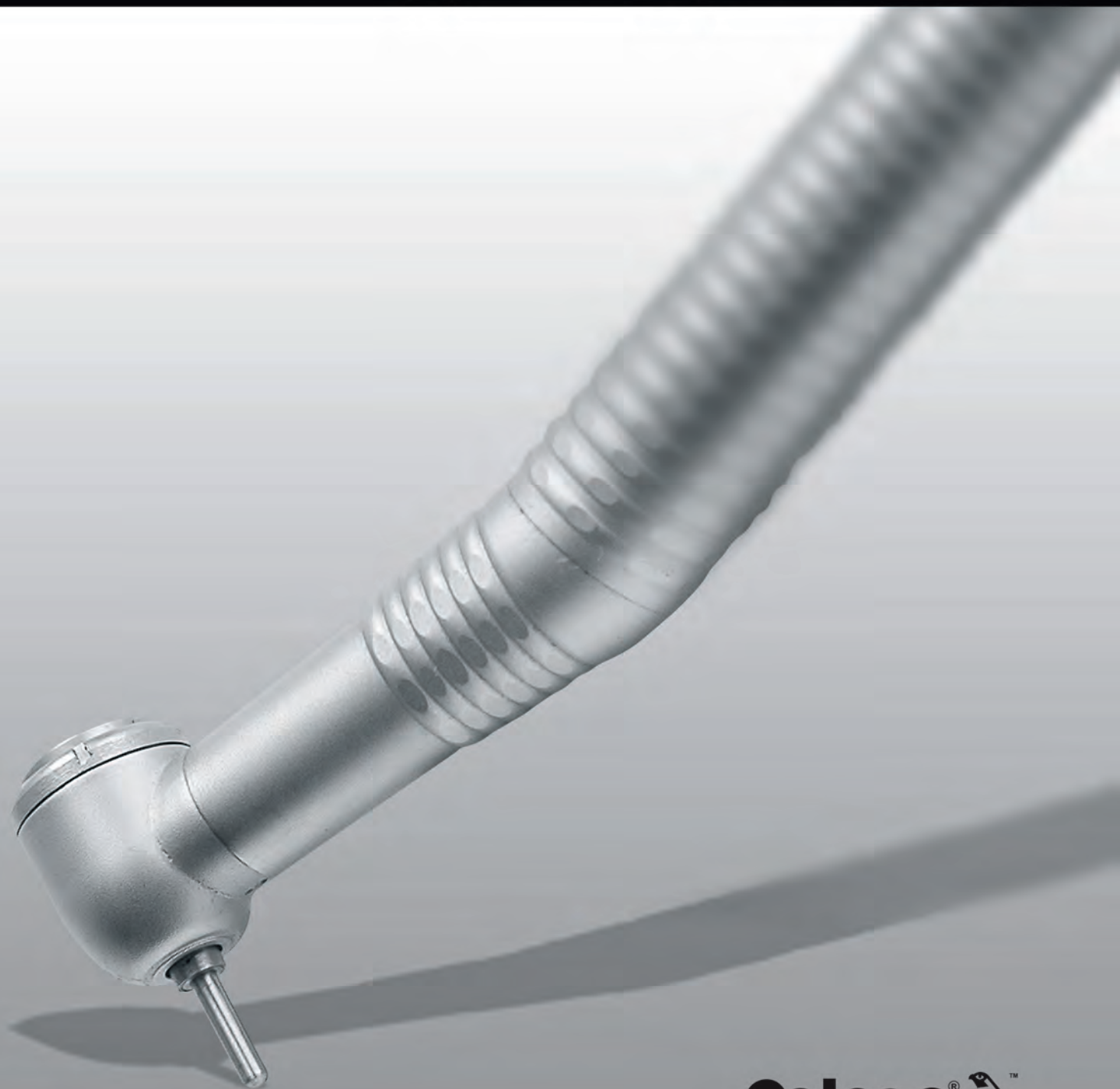



High speed air turbine fibre optic handpieces
Końcówki stomatologiczne (turbiny) szybkoobrotowe
pneumatyczne z podświetleniem

2 Year Guarantee / 2 lata gwarancja

- Ceramic bearings
- Quiet operation
- Perfect balance
- Anti-retraction valve
- Push button chuck
- Quick coupling fitting

- Łożyska ceramiczne
- Cicha praca
- Małe wibracje
- Zawór anti-retrakcyjny
- Wymiana wiertel za pomocą przycisku
- Wymagana szybkozłączka



Specifications / Specyfikacja techniczna

Code / Kod	DQ.2100.00
Head / Główka	Torque / Tork
Head size / Rozmiar głowicy	Ø 14.6 mm
Maximum speed / Maksymalna prędkość	300,000~ 380,000 R.P.M.
Cooling / Aerosol	4-Spray / Poczwórny
Bur size / Rozmiar wiertel	Ø 1.59 ~ 1.60 mm FG
Compatible / Kompatybilność	KaVo@MULTiflex™

Specifications / Specyfikacja techniczna

Code / Kod	DQ.2100.25
Head / Główka	Mini / Mini
Head size / Rozmiar głowicy	Ø 12.6 mm
Maximum speed / Maksymalna prędkość	300,000~ 380,000 R.P.M.
Cooling / Aerosol	Single / Pojedynczy
Bur size / Rozmiar wiertel	Ø 1.59 ~ 1.60 mm FG
Compatible / Kompatybilność	KaVo@MULTiflex™

High speed air turbine handpieces
Końcówki stomatologiczne (turbiny) szybkoobrotowe
pneumatyczne

Torque head handpieces / końcówki stomatologiczne głowka Torque

- Anti-retraction valve
- Ceramic bearings
- Push button chuck
- Quick coupling fitting

- Zawór anti-retrakcyjny
- Łożyska ceramiczne
- Wymiana wiertel za pomocą przycisku
- Wymagana szybkozłączka

1 Year Guarantee / Rok gwarancji



Specifications / Specyfikacja techniczna

Code / Kod	DQ.2200.00
Head / Główka	Mini
Head size / Rozmiar głowicy	Ø 11.2 mm
Length / Długość	13.2 mm
Maximum speed / Maksymalna prędkość	320,000~ 420,000 R.P.M.
Cooling / Aerosol	Single / Pojedynczy
Bur size / Rozmiar wiertel	Ø 1.59 ~ 1.60 mm FG
Recommended air pressure	2.0-2.5 kg / cm ² ; (0.2- 0.25 Mpa)
Rekomendowane ciśnienie powietrza	2.0-2.5 kg / cm ² ; (0.2- 0.25 Mpa)
Length / Długość	Standard
Compatible / Kompatybilność	NSK

Specifications / Specyfikacja techniczna

Code / Kod	DQ.2225.00
Head / Główka	Standard
Head size / Rozmiar głowicy	Ø 13.2 mm
Length / Długość	14.6 mm
Maximum speed / Maksymalna prędkość	300,000~ 350,000 R.P.M.
Cooling / Aerosol	Single / Pojedynczy
Bur size / Rozmiar wiertel	Ø 1.59 ~ 1.60 mm FG
Recommended air pressure	2.0-2.5 kg / cm ² ; (0.2- 0.25 Mpa)
Rekomendowane ciśnienie powietrza	2.0-2.5 kg / cm ² ; (0.2- 0.25 Mpa)
Length / Długość	Standard
Compatible / Kompatybilność	NSK

Standard head handpieces / końcówki stomatologiczne główka standard

- Anti-retraction valve • Zawór anti-retrakcyjny
- Ceramic bearings • Łożyska ceramiczne
- Quick coupling fitting • Wymagana szybkozłączka

Standard Torque, push button chuck
Główka Standard, wymiana wiertel za pomocą przycisku



Specifications / Specyfikacja techniczna

Code / Kod	DQ.2325.00
Head / Główka	Standard
Head size / Rozmiar głowicy	Ø 11.2 mm
Length / Długość	14.6 mm
Maximum speed / Maksymalna prędkość	320,000~ 420,000 R.P.M.
Cooling / Aerosol	Single / Pojedynczy
Bur size / Rozmiar wiertel	Ø 1.59 ~ 1.60 mm FG
Recommended air pressure Rekomendowane ciśnienie powietrza	2.0-2.5 kg / cm ² ; (0.2- 0.25 Mpa)
Length / Długość	Standard
Compatible / Kompatybilność	NSK

Standard Torque, wrench type chuck
Główka Standard, mocowanie wiertel za pomocą klucza



Specifications / Specyfikacja techniczna

Code / Kod	DQ.2375.00
Head / Główka	Standard
Head size / Rozmiar głowicy	Ø 10.2 mm
Length / Długość	13.6 mm
Maximum speed / Maksymalna prędkość	300,000~ 350,000 R.P.M.
Cooling / Aerosol	Single / Pojedynczy
Bur size / Rozmiar wiertel	Ø 1.59 ~ 1.60 mm FG
Recommended air pressure Rekomendowane ciśnienie powietrza	2.0-2.5 kg / cm ² ; (0.2- 0.25 Mpa)
Length / Długość	Standard
Compatible / Kompatybilność	NSK

Standard head handpieces / końcówki stomatologiczne główka standard

- Anti-retraction valve • Zawór anti-retrakcyjny
- Ceramic bearings • Łożyska ceramiczne

Standard Torque, push button chuck
Główka Standard, wymiana wiertel za pomocą przycisku



Specifications / Specyfikacja techniczna

Code / Kod	DQ.2425.02
Connection / Złącze	2-holes / 2-otworowe Borden
Head / Główka	Standard
Head size / Rozmiar głowicy	Ø 11.2 mm
Length / Długość	14.6 mm
Maximum speed / Maksymalna prędkość	320,000~ 420,000 R.P.M.
Cooling / Aerosol	Single / Pojedynczy
Bur size / Rozmiar wiertel	Ø 1.59 ~ 1.60 mm FG
Recommended air pressure Rekomendowane ciśnienie powietrza	2.0-2.5 kg / cm ² ; (0.2- 0.25 Mpa)
Length / Długość	Standard
Compatible / Kompatybilność	NSK

Standard Torque, push button chuck
Główka Standard, wymiana wiertel za pomocą przycisku



Specifications / Specyfikacja techniczna

Code / Kod	DQ.2425.04
Connection / Złącze	4-holes / 4-otworowe Midwest
Head / Główka	Standard
Head size / Rozmiar głowicy	Ø 11.2 mm
Length / Długość	14.6 mm
Maximum speed / Maksymalna prędkość	320,000~ 420,000 R.P.M.
Cooling / Aerosol	Single / Pojedynczy
Bur size / Rozmiar wiertel	Ø 1.59 ~ 1.60 mm FG
Recommended air pressure Rekomendowane ciśnienie powietrza	2.0-2.5 kg / cm ² ; (0.2- 0.25 Mpa)
Length / Długość	Standard
Compatible / Kompatybilność	NSK



Standard head handpieces / końcówki stomatologiczne główka standard

- Anti-retraction valve
- Ceramic bearings
- Zawór anty-retrakcyjny
- Łożyska ceramiczne

Standard Torque, wrench type chuck
Główka Standard, mocowanie wiertel za pomocą klucza



Specifications / Specyfikacja techniczna

Code / Kod	DQ.2475.02
Connection / Złącze	2-holes / 2-otworowe Borden
Head / Główka	Standard
Head size / Rozmiar głowicy	Ø 10.2 mm
Length / Długość	13.2 mm
Maximum speed / Maksymalna prędkość	320,000~ 420,000 R.P.M.
Cooling / Aerosol	Single / Pojedynczy
Bur size / Rozmiar wiertel	Ø 1.59 ~ 1.60 mm FG
Recommended air pressure	2.0-2.5 kg / cm ² ; (0.2- 0.25 Mpa)
Rekomendowane ciśnienie powietrza	
Length / Długość	Standard
Compatible / Kompatybilność	NSK

Standard Torque, wrench type chuck
Główka Standard, mocowanie wiertel za pomocą klucza



Specifications / Specyfikacja techniczna

Code / Kod	DQ.2475.04
Connection / Złącze	4-holes / 4-otworowe Midwest
Head / Główka	Standard
Head size / Rozmiar głowicy	Ø 10.2 mm
Length / Długość	13.2 mm
Maximum speed / Maksymalna prędkość	320,000~ 420,000 R.P.M.
Cooling / Aerosol	Single / Pojedynczy
Bur size / Rozmiar wiertel	Ø 1.59 ~ 1.60 mm FG
Recommended air pressure	2.0-2.5 kg / cm ² ; (0.2- 0.25 Mpa)
Rekomendowane ciśnienie powietrza	
Length / Długość	Standard
Compatible / Kompatybilność	NSK

Contra angle handpiece 1:1
Kątница z przełożeniem 1:1



Fully autoclavable
Możliwość sterylizacji wszystkimi sposobami



Push button chuck
Wymiana wiertel za pomocą przycisku



Specifications / Specyfikacja techniczna

Code / Kod	DQ.2800.00
Head / Główka	Standard
Head size / Rozmiar głowicy	Ø 8 mm
Length / Długość	13.2 mm
Maximum speed / Maksymalna prędkość	30,000 R.P.M.
Cooling / Aerosol	Single / Pojedynczy
Bur size / Rozmiar wiertel	Ø 2.35 RA

Low speed straight handpiece 1:1
Prostnica z przełożeniem 1:1



Fully autoclavable
Możliwość sterylizacji wszystkimi sposobami



Specifications / Specyfikacja techniczna

Code / Kod	DQ.2800.01
Head / Główka	Standard
Head size / Rozmiar głowicy	Ø 10.2 mm
Length / Długość	13.2 mm
Maximum speed / Maksymalna prędkość	30,000 R.P.M.
Cooling / Aerosol	Single / Pojedynczy
Bur size / Rozmiar wiertel	Ø 2.35 HP

Quick swivel couplings / Szybkozłączeni

- Anti-retraction valve
- 360° swivels
- Fully autoclavable
- Zawór anti-retrakcyjny
- Możliwość obrotu 360°
- Możliwość sterylizacji wszystkimi sposobami



DQ.2500.02
2-holes Borden
złącze 2-otworowe Borden



DQ.2500.04
4-holes Midwest
złącze 4-otworowe Midwest



DQ.2525.00
4-holes Midwest
złącze 4-otworowe Midwest

**Silicone handpiece tubing
Przewód silikonowy do końcówek**



DQ.2600.02
2-holes Borden
Złącze 2 otworowe Borden
1,6 meters with adapter
1,6 m długość z łącznikiem

Connects to any ISO-C4 hole non fiber optic swivel. Durable and flexible silicone, integrated cable support, ISO 9168, 2 years limited warranty



DQ.2600.04
4-holes Midwest
Złącze 4 otworowe Midwest
1,6 meters with adapter
1,6 m długość z łącznikiem

Connects to any ISO-C4 hole non fiber optic swivel. Durable and flexible silicone, integrated cable support, ISO 9168, 2 years limited warranty



DQ.2600.06
6-holes Midwest
Złącze 6 otworowe Midwest
1,6 meters with adapter
1,6 m długość z łącznikiem

Connects to any ISO-C4 hole non fiber optic swivel. Durable and flexible silicone, integrated cable support, ISO 9168, 2 years limited warranty

**Polyurethane tube for air water syringe, 2-holes
Poliuretanowy przewód do dmuchawek, 2-otworowy**



DQ.2710.02
2 meters long / 2 m długości

**Fibre optic system
System podświetlenia**



DQ.2610.00
2 handpieces output unit
Możliwość podłączenia 2 końcówek
Transformer / Zasilacz



3-1 Air water syringes and accessories
Dmuchałki wodno-powietrzne trójdrożne i akcesoria



DQ.2700.00

Complete with 2 tips
Komplet z 2 końcówkami

DQ.2705.00

Complete with tip
Komplet z końcówką

3-1 Air water syringe tips
Końcówki do dmuchałek



DQ.2707.00
Each / Sztuka

DQ.2708.00
Pack of 250 pieces / Opak. 250 szt.

DQ.2708.01
Pack of 250 pieces / Opak. 250 szt.

Microblaster for extraoral use / Piaskarka do użytku zewnętrznego



DQ.3005.01

Mikro piaskarka do:

- usuwania cementu z metalu, żywicy i innych materiałów protetycznych;
- piaskowania - czyszczenia elementów "inlay-onlay" z kompozytów, ceramiki i cyrkonu;
- czyszczenie metali, ceramiki, cyrkonu w ustach pacjenta przed naprawą;
- piaskowania abrazyjnego w celu dokładnej regulacji zgryzu;
- wykonania korekty wewnętrznej konstrukcji protetycznych dotyczące ustalenia "pasowania" wzajemnych relacji;
- precyzyjne usuwanie tlenków.

W zestawie sprzęgło do podłączenia w systemie Borden lub Midwest.

Air polisher handpieces / Piaskarki

- For intraoral use
- Light weight and ergonomic design
- Detachable nozzle
- Do użytku wewnątrz jamy ustnej
- Lekka waga i ergonomiczny kształt
- Wymienna końcówka



P-Mate-II

DQ.3000.06 2-holes Borden / złącze 2-otworowe Borden
DQ.3000.08 4-holes Midwest / złącze 4-otworowe Midwest



Manual cleaning and cold sterilization only
Czyszczenie ręczne i sterylizacja na zimno



P-Mate-I

DQ.3000.02 2-holes Borden / złącze 2-otworowe Borden
DQ.3000.04 4-holes Midwest / złącze 4-otworowe Midwest



Handpiece lubricant spray
Olej do konserwacji końcówek



DQ.2101.00
500ml

DQ.2101.01
500ml

DQ.2101.02
500ml

Spittoon filter
Siatko z przykrywką do sopluczki



DQ.9100.00

Polishing powder for P-Mate handpieces
Piasek do piaskarki stomatologicznej



Proszek do profilaktycznego piaskowania zębów, przeznaczony do wszystkich urządzeń do piaskowania. Dostępny w czterech smakach: cytryna, mięta, wiśnia, porzeczka.

- DQ.3001.04 Lemon / Cytrynowy
 - DQ.3001.05 Mint / Miętowy
 - DQ.3001.06 Cherry / Wiśnia
 - DQ.3001.07 Cassis / Porzeczkowy
- 300g

Sealing machine and accessories
Zgrzewarka i akcesoria

1 year guarantee for equipment, heating element or other parts may need replacement depending on frequency of use or misuse.

1 rok gwarancji – dotyczy wad fabrycznych zgrzewarki. Elementy wymienne do zgrzewania nie są objęte gwarancją.

- Sealing width 10 mm
- Maximum width of sealing 200 mm
- Szerokość zgrzewu 10 mm
- Maksymalna szerokość rękawa 200 mm



DQ.9000.01

Code / Kod	Product / Produkt
DQ.9000.02	Roll stand only / Stojak na rękaw
DQ.9000.03	Worktable only / Stolik



DQ.9000.00
Complete with roll stand and working table
Komplet zawiera stojak na rękaw i stolik



DQ.9000.06
Teflon sealing tape
Taśma teflonowa



DQ.9000.05
Cutting blade and handle
Nóż obcinający z uchwytem



DQ.9000.07
Upper rubber strip
Listwa gumowa górna



DQ.9000.04
Heating element
Paski do zgrzewu



Vacuum forming machine
Pomierz próżniowy



DQ.9001.01

A powerful 1400W motor, it automatically generates the vacuum at the conformation instant. The Plastvac P7 does not need a special installation, since it is connected to the consulting / laboratory power grid. Quick and practical, possibility the confection and delivery of sheets to the patient in a single session. On average the payback comes with the production of 30 sheets. The Plastvac P7 has a universal adapter for round and square sheets of different dimensions, thicknesses and materials.

Applications:

- Mouthguard
- Matrix for composite resin
- Temporary bridge;
- Caps;
- Fixing of brackets
- Fluoridation mold
- Surgical guide
- Bite plate (bruxism)
- Base sheet
- Individual sheet
- Homemade whitening sheets
- Packing of study models

Technical specifications

- Automatic vacuum activation;
- Available in voltages: 110 or 220V (not Bivolt)
- Weight: 5.4 kg
- Dimensions: (WxDxH) 24x27x19 cm.

Urządzenie próżniowe do formowania płytek termoplastycznych. Potężny motor generuje próżnię automatycznie w chwili opuszczenia nagrzonej platformy z płytką termoplastyczną.

Dane techniczne:

- Ruchoma półka pod model. Możliwość umieszczenia modelu bezpośrednio na półce lub z zastosowaniem szklanych kulek (przy dużych podcieniach lub twardych płytkach). Ceramiczne oporowe włókno węglowe, zapewnia jednolite ogrzewanie płytek.
- Obrotowa platforma na płytce - Umożliwia jednolite ogrzewanie obu stron płytki termoplastycznej.
 - Automatyczny start próżni
 - Napięcie: 110 albo 220V
 - Waga: 5,4 Kg
 - Wymiary: 24x27x19 cm.

Zastosowanie:

- Ochroniacze ust
- Forma dla żywicy
- Prowizoryczne mosty
- Łyżki do fluoryzacji
- Szablony chirurgiczne
- Płytki zgryzowe (bruxizm)
- Płyty wzorników
- Łyżki indywidualne
- Szyny do wybielania
- Opakowania dla modeli

Cordless light curing unit
lampa polimeryzacyjna bezprzewodowa



DQ.9001.02

C01-D LED Curing Light with Fibre Optic Light Guide with Dual Wavelength

- Model – C01-D (Dual Range)
F.O. Light Guide – 11mm (dia)
Light Wavelength – 390–430nm/440–480nm (dual wavelength enables the unit to cure all composites on the market today)
Application – Ortho/General
Mode –
Tack – 2,000 mW/cm2 for 1 second ± 10%
Turbo – 2,000 mW/cm2 for 4 seconds ± 10%
3' + 3' – 2,000 mW/cm2 for 3 + 3 seconds ± 10% (with 1 second blink in between)
6' + 6' – 1,500 mW/cm2 for 6 + 6 seconds ± 10% (with 1 second blink in between)
Full – 1,200 mW/cm2 for 5, 10, 15, 20 seconds ± 10%
Ramp – 1st five seconds from 0 – 1,200 mW/cm2, next 5, 10, 15, 20 seconds 1,200 mW/cm2 ± 10%
Soft Cure – 1st five seconds from 0 – 900 mW/cm2, next 5, 10, 15, 20, 25 seconds 900 mW/cm2 ± 10%
C01 complete set with Built-in light intensity indicator
24 Month Warranty
Spare parts available:
C01-S/D1 11mm Fibre Optic Light Guide
C01/2-1 Replacement Battery

Lampa polimeryzacyjna C01-D

Bezprzewodowa lampa polimeryzacyjna marki: Premium Plus to nowoczesne i estetycznie wykonane narzędzie, niezbędne w pracy każdego gabinetu.

Opis:

- dioda LED 5W
- natężenie światła: 900mW/cm2 – 1500mW/cm2
- długość wiązki: 440–480nm
- bezprzewodowe narzędzie wraz z ładowarką i wbudowanym akumulatorem
- sterylizowalny światłowód, o średnicy 11mm
- ergonomiczny kształt
- stabilne i intensywne światło niezależne od stopnia naładowania akumulatora
- aż cztery tryby pracy: turbo, pełny, pulsacyjny, miękki
- wymienna bateria
- obustronne ułożenie przycisków, dla lewo i praworęcznej pracy
- 4 tryby czasu pracy: 5s, 10s, 15s, 20s
- czas do pełnego naładowania - 3-4h
- czas pracy – 200 cykli po 10s na pełnej baterii.

D₄

Ultrasonic Tips / Końcówki ultradźwiękowe





Surgery tips / Końcówki chirurgiczne



Type M / Typ M US1 DS.002.010 US2 DS.002.020 US3 DS.002.030 US4 DS.002.040 US5 DS.002.050



Type M / Typ M UL1 DS.003.010 UL2 DS.003.020 UC1 DS.004.010 UL3 DS.003.030 UL4 DS.003.040

Cavity preparation tips / Końcówki do preparacji ubytków



Diamond Coated
Diamentowy nasyp



Type / Typ E SB1 DR.300.010 SB2 DR.300.020 Half ball straight Połowa kulki, ustawiona prosto SB3 DR.300.030 Half ball straight Połowa kulki, ustawiona prosto SBL DR.301.010 Half ball left Połowa kulki, ustawiona na lewo SBR DR.301.020 Half ball right Połowa kulki, ustawiona na prawo

Scaling tips / Końcówki do skalingu



Type / Typ E G1 DP.005.010 G2 DP.005.020 G3 DP.005.030 G4 DP.005.040
Type / Typ S G1 DP.006.010 G2 DP.006.020 G3 DP.006.030 G4 DP.006.040



Type / Typ E G5 DP.005.050 G6 DP.005.060
Type / Typ S G5 DP.006.050 G6 DP.006.060

NiTi endodontic files / Piłniki kanałowe NiTi

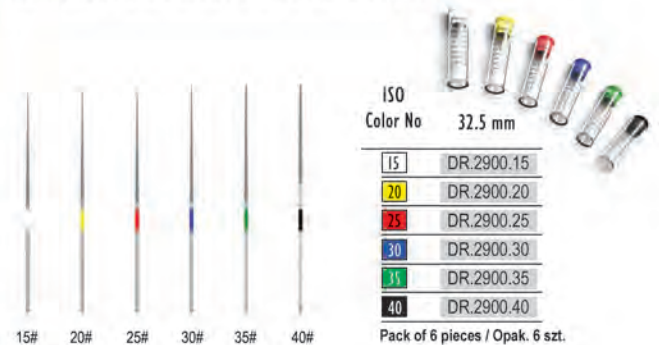

Scaling tips / Końcówki do skalingu



GS1
DP.011.010

Type / Typ Sirona

GS2
DP.011.020



GS3
DP.011.030

Type / Typ Sirona

GS4
DP.011.040



GS5
DP.011.050

Type / Typ Sirona

GS6
DP.011.060



GK1
DP.012.010

Type / Typ Kavo

GK2
DP.012.020



GK3
DP.012.030

Type / Typ Kavo

GK4
DP.012.040



GK5
DP.012.050

Type / Typ Kavo

GK6
DP.012.060

Periodontal tips \ Końcówki do periodontologii



P3D

P4D

P1

P3

P4

Type / Typ E

DP.009.030

DP.009.040

DP.007.010

DP.007.030

DP.007.040

Type / Typ S

DP.010.030

DP.010.040

DP.008.010

DP.008.030

DP.008.040



Endodontic files holders \ Końcówki do pilników kanałowych

Endodontic tips \ Końcówki endodontyczne



E1

E2

Type / Typ E DR.2990.01

DR.2990.02

Type / Typ S DR.2991.01

DR.2991.02



E3

Type / Typ E DR.2990.03

Endo wrench / Kluczyk płaski

Type / Typ S DR.2991.03

DR.2990.00



ES1

ES2

Type / Typ S DR.2993.01

DR.2993.02

Torque wrench
Klucz nasadkowy



DP.004.010



DP.004.011

Ultrasonic scaler Handpieces / Rękojeść do końcówek

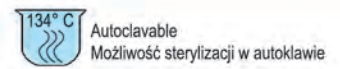

Type / Typu E
DQ.2900.00

Rękojeść skalera kompatybilna ze skalerami
Typ EMS-Mectron



Type / Typu E
DQ.2900.01

Rękojeść skalera HW-3H kompatybilna ze skalerami
Typ EMS-Mectron



Type / Typu E
DQ.2900.02

Rękojeść skalera HW-6 kompatybilna ze skalerami
Typ EMS-Mectron

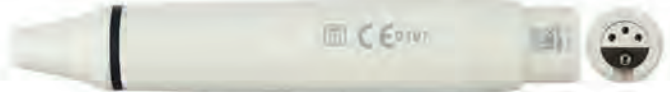

Type / Typu S
DQ.2901.00

Rękojeść skalera HD-7H kompatybilna ze skalerami
Typ NSK-Satelec

Tightening key
Klucz do końcówek do skallingu



Tips holder
Podstawa na końcówki ultradźwiękowe



Quick connector
Łącznik



D5

Diagnostics / Diagnostyka

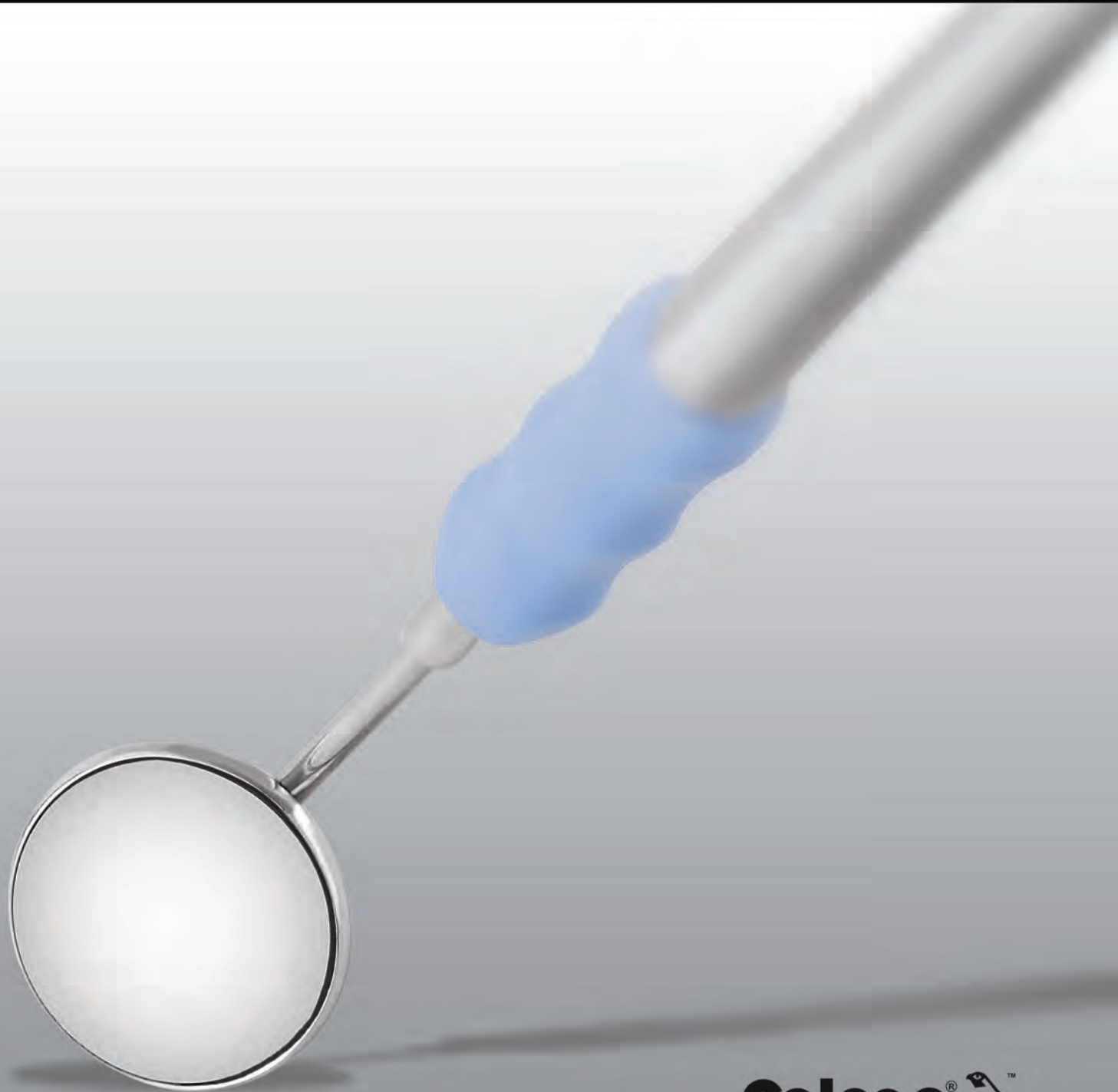

SS-200 mouth mirrors / SS-200 Lusterka

Made of 18-8 Stainless steel
Sterilizable up to 200° C
Best reflection and image quality
Wide variety
Pack of 12 pieces / Opak. 12 szt.

Wykonane ze stali nierdzewnej 18-8
Sterylizacja do 200° C
Bardzo dobre odbicie i wysoka jakość obrazu
Szeroka oferta



	Fig. 2 Ø 18 mm	Fig. 3 Ø 20 mm	Fig. 4 Ø 22 mm	Fig. 5 Ø 24 mm
Chrome Coated / Pokryte chromem			DD.503.040	DD.503.050
Magnifying / Powiększające	DD.506.020	DD.506.030	DD.506.040	DD.506.050
Plane / Płaskie	DD.509.020	DD.509.030	DD.509.040	DD.509.050

Single reflection, sharp image quality
Pojedyncze odbicie, wyraźny obraz

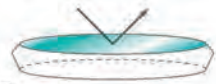

Front surface, chrome coated
Powierzchnia lusterka pokryta chromem

Front surface
Powierzchnia lusterka

**Perfection mouth mirrors
Lusterka typ Perfection**



Chrome coated front surface mirror
Wide stem offer comfortable cheek retraction

Powierzchnia lusterka pokryta chromem
Duża wygoda przy odciąganiu policzka- szeroka rękojeść



Each / Sztuka

Fig. 4
Ø 22 mm

Fig. 5
Ø 24 mm

Chrome Coated / Pokryte chromem	DD.515.040	DD.515.050
---------------------------------	------------	------------

Single reflection, sharp image quality
Pojedyncze odbicie, wyraźny obraz



Front surface
Powierzchnia lusterka

**Micro mirrors chrome coated
Mikro lusterka pokryte chromem**

Each / Sztuka



Front surface mirror
lusterka przedniopowierzchniowe

Chrome Coated / Pokryte chromem

Fig. 000
Ø 10 mm

Fig. 00
Ø 12mm

Plane / Płaskie	DD.494.000	DD.495.000
-----------------	------------	------------

Single reflection, sharp image quality
Pojedyncze odbicie, wyraźny obraz



Front surface
Powierzchnia lusterka

**TOPvision
Front surface rhodium coated mouth mirrors
Lusterka przedniopowierzchniowe rodowe**



Each / Sztuka

Rhodium Coated / Pokryte rodowe

Fig. 000
Ø 10 mm

Fig. 00
Ø 12mm

Plane / Płaskie	DD.7190.00	DD.7190.12
-----------------	------------	------------



Made in Germany

**Mouth mirrors Economy
Lusterka Economy**



High image quality

The Economy mouth mirrors have a threefold pure silver coating. The reflection is bright and offers high image quality.

High resistance against disinfection and sterilisation
The silver coating is protected with a copper layer and it's additionally sealed with a special protective film.

Pack of 12 pieces / Opak. 12 szt.

Plane / Płaskie	DD.7700.40	DD.7700.50
-----------------	------------	------------

Fig. 4
Ø 22 mm

Fig. 5
Ø 24mm



Made in Germany

**MEGA FS
Front surface mouth mirrors
Lusterka przedniopowierzchniowe**



Bright and brilliant reflection in natural colours
thanks to an optimal reflection spectrum.

High sight comfort
gentle to the eye and good for fatigue-proof working.

Easy cleaning
due to the anti-stick effect of the special HAHNENKRATT front surface coating

Unlimited resistance
against disinfection and sterilisation, even against acid containing refresh liquids.

Plane / Płaskie	DD.6560.40	DD.6561.50
-----------------	------------	------------

Fig. 4
Ø 22 mm

Fig. 5
Ø 24mm

Single reflection, sharp image quality
Pojedyncze odbicie, wyraźny obraz

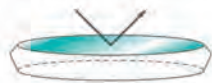

Front surface
Powierzchnia lusterka



Made in Germany

TOPvision
Front surface rhodium coated mouth mirrors
Lusterka przedniopowierzchniowe rodowe



TOPvision FS Rhodium are coated with Rhodium on the front surface. Rhodium is a precious metal as gold and as a precious metal it's chemical resistant, even against acids.

The TOPvision FS Rhodium features are:
Images of exact sharpness and contrast up to the smallest detail, without any distortion

Bright and brilliant reflection in natural colours thanks to an optimal reflection spectrum.

Highest sight comfort
gentle to the eye and good for fatigue-proof working

Easy cleaning
due to the anti-stick effect of the special HAHNENKRATT front surface coating

Unlimited resistance
against disinfection and sterilisation, even against acid containing refresh liquids.

	Fig. 4 Ø 22 mm	Fig. 5 Ø 24 mm
Pack of 12 pieces / Opak. 12 szt.		
Plane / Plaskie	DD.7210.40	DD.7210.50



Made in Germany

Single reflection, sharp image quality
Pojedyncze odbicie, wyraźny obraz



Front surface
Powierzchnia lusterka

MEGAretract
Front surface rhodium coated mouth mirrors
Lusterka przedniopowierzchniowe rodowe



Comfortable cheek retraction by a wide and flat stem design. The cheek retraction aspect of the mirror has less potential for discomfort to the patient.

Hygienic by the plane surface that avoids deposits
No disturbing reflection by satin-finished stainless steel surface

Images of exact sharpness and contrast up to the smallest detail, with out any distortion. The combination of bright and brilliant natural colours guarantees highest sight comfort, gentle to the eye and good for fatigue-proof working.

Easy cleaning due to the anti-stick effect of the special HAHNENKRATT front surface coating

	Fig. 4 Ø 22 mm	Fig. 5 Ø 24 mm	Fig. 4 Ø 22 mm	Fig. 5 Ø 24 mm
Pack of 6 pieces / Opak. 6 szt.				
Plane / Plaskie	DD.6660.40	DD.6661.50	DD.6680.40	DD.6681.50

Single reflection, sharp image quality
Pojedyncze odbicie, wyraźny obraz

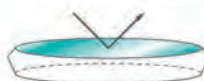

Front surface
Powierzchnia lusterka



Bifurcated stem / Rozwidlony trzon

Fig. 4 Ø 22 mm
Fig. 5 Ø 24 mm

ULTRAvision
Front surface mouth mirrors
Lusterka przedniopowierzchniowe



The ULTRAvision features are:
Highest reflection with crystal clear brightness
Superior colour accuracy, without any discoloration
Exact sharpness
Scratch resistant



The splitted mirror shows the crystal clear bright reflection of the ULTRAvision compared to Rhodium



Made in Germany

Single reflection, sharp image quality
Pojedyncze odbicie, wyraźny obraz

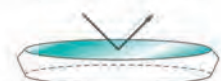

Front surface
Powierzchnia lusterka

	Fig. 4 Ø 22 mm	Fig. 5 Ø 24 mm
Pack of 12 pieces / Opak. 12 szt.		
Plane / Plaskie	DD.5330.40	DD.5330.50

ULTRAretract
Front surface mouth mirrors
Lusterka przedniopowierzchniowe



The splitted mirror shows the crystal clear bright reflection of the ULTRAvision compared to Rhodium

The ULTRA FS features are:
Highest reflection with crystal clear brightness
Superior colour accuracy, without any discoloration
Exact sharpness
Scratch resistant
Improved comfortable cheek retraction



Single reflection, sharp image quality
Pojedyncze odbicie, wyraźny obraz



Pack of 6 pieces / Opak. 6 szt.	Fig. 4 Ø 22 mm	Fig. 5 Ø 24mm
Plane / Płaskie	DD.6670.40	DD.6671.50

ULTRAduo
Double sided front surface mouth mirrors
Lusterka dwustronne przedniopowierzchniowe



The splitted mirror shows the crystal clear bright reflection of the ULTRAvision compared to Rhodium

The ULTRA FS features are:
Highest reflection with crystal clear brightness
Superior colour accuracy, without any discoloration
Exact sharpness
Scratch resistant
Improved comfortable cheek retraction

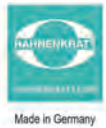

Single reflection, sharp image quality
Pojedyncze odbicie, wyraźny obraz



Pack of 6 pieces / Opak. 6 szt.	Fig. 4 Ø 22 mm	Fig. 5 Ø 24mm
Plane / Płaskie	DD.6640.40	DD.6641.50

Micro Mirrors
Mikro lusterko endodontyczne

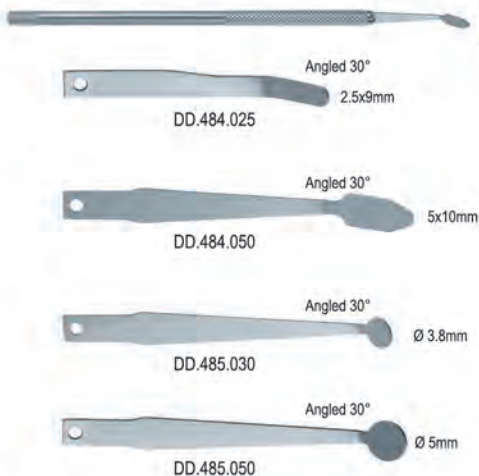

D-Lite illuminated mouth mirror
Lusterko podświetlone



DD.035.000
Complete with batteries
Komplet z baterii



Each / Sztuka
DD.035.010
Single-Use Mirror /
Lusterka jednorazowa

DD.035.020
Spare battery /
zapasowych baterii



Mirror handles / Uchwyty do lusterka

Easy
COLOR



Autoclavable
Możliwość sterylizacji w autoklawie

Silicone handle with Aluminum core
Uchwyt silikonowy z rdzeniem aluminiowym



DD.528.010
Black / Czarny



DD.528.020
Blue / Niebieski



DD.528.030
Light blue / Jasnyniebieskie



DD.528.040
Brown / Brązowy



DD.528.050
Green / Zielony



DD.528.060
Grey / Szary



DD.528.070
Orange / Pomarańczowy



DD.528.080
Pink / Jasnoróżowy



DD.528.090
Purple / Purpurowy



DD.528.100
Red / Czerwony



DD.528.110
Turquoise / Turkus

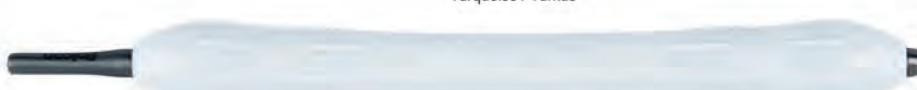

DD.528.120
White / Biały



DD.528.130
Yellow / Żółty

Micro mirror handles
Uchwyty do lusterka mikro

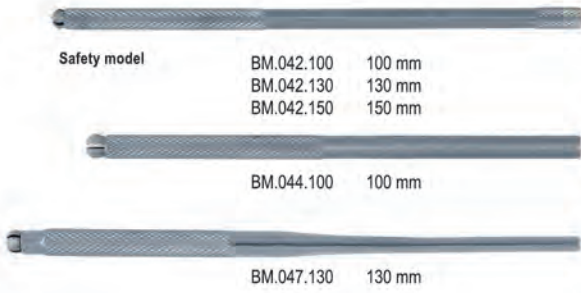

Mirror handles
Uchwyty do lusterka

SOFT LINE INSTRUMENTS
soft and sure grip



- DD.526.010
Blue / Niebieski
- DD.526.020
Olive / Oliwkowy
- DD.526.030
Yellow / Żółty
- DD.526.040
Red / Czerwony
- DD.526.050
Orange / Pomarańczowy

Pack of 5 pieces
Opak. 5 sztuk



DD.526.000

LED Examination Light
Latarka diagnostyczna LED z regulacją światła



DD.040.000

Mirror handles / Uchwyty do lusterek

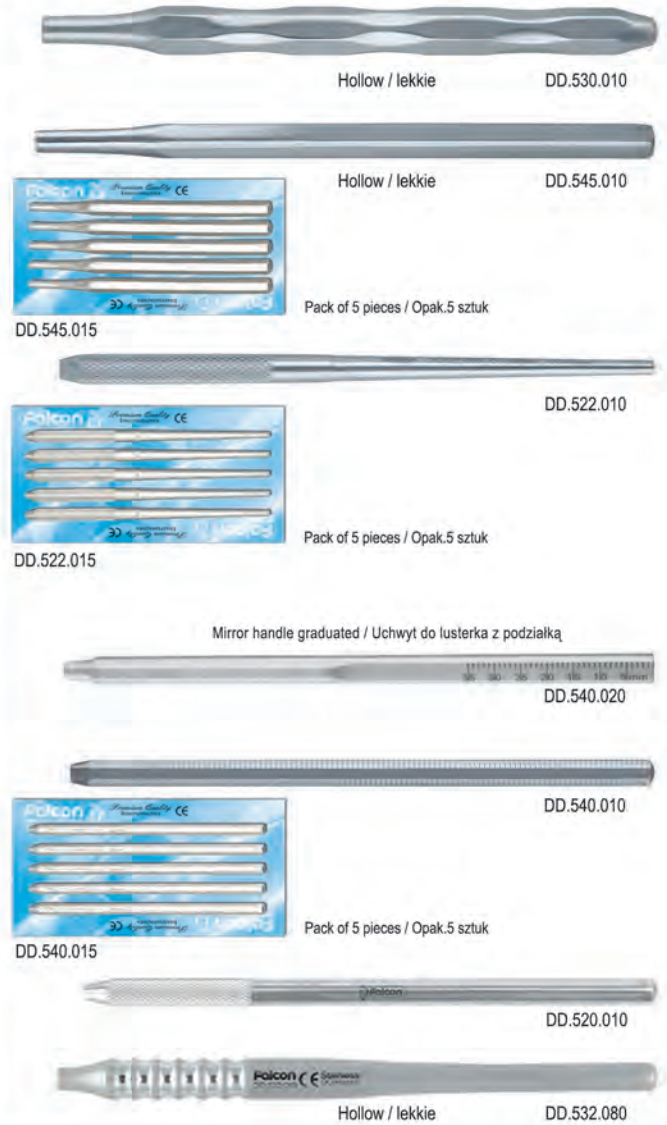

Serie-UNO
Economical dental instruments
Instrumenty stomatologiczne w atrakcyjnej cenie

135° C Autoclavable
Możliwość sterylizacji w autoklawie

Mirror handle / Uchwyt do lusterek



Explorers single ended rigid / Zgłębniki jednostronne twarde





Explorers double ended flexible
Zgłębniki dwustronne miękkie

Classic Round 6 mm solid handle
6 mm pełny uchwyt



DD.161.050 Fig. 5
Pack of 5 pieces / Opak. 5 szt.

Explorers double ended rigid
Zgłębniki dwustronne twarde

Classic Round 6 mm solid handle
6 mm pełny uchwyt



DD.160.170 Fig. 23/17
Pack of 5 pieces / Opak. 5 szt.

Explorers double ended rigid
Zgłębniki dwustronne twarde

SOFT LINE INSTRUMENTS
soft and sure grip



Expro (explorer-probe combination)
Zgłębnik-Sonda



SOFT LINE INSTRUMENTS
soft and sure grip *Color Coded*



Periodontal probe
Sonda periodontyczna



Explorers single ended flexible
Zgłębniki jednostronne miękkie

Classic Round 6 mm solid handle
6 mm pełny uchwyt



DD.211.060 Fig. 6
DD.211.061 Fig. 6A
DD.211.090 Fig. 9
DD.211.230 Fig. 23
DD.211.320 Fig. 32

Pack of 5 pieces / Opak. 5 szt.



Explorers single ended rigid
Zgłębniki jednostronne twarde

SOFT LINE INSTRUMENTS
soft and sure grip

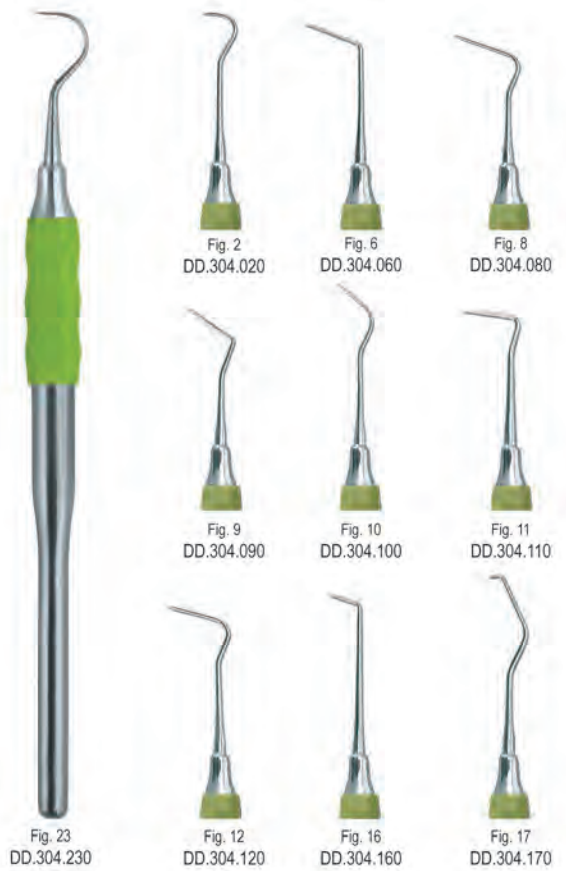

Explorers single ended rigid
Zgłębniki jednostronne twarde

Classic Round 6 mm solid handle
6 mm pełny uchwyt



DD.313.060 Fig. 6
DD.313.090 Fig. 9
DD.313.110 Fig. 11
DD.313.160 Fig. 16
DD.313.230 Fig. 23

Pack of 5 pieces / Opak. 5 szt.

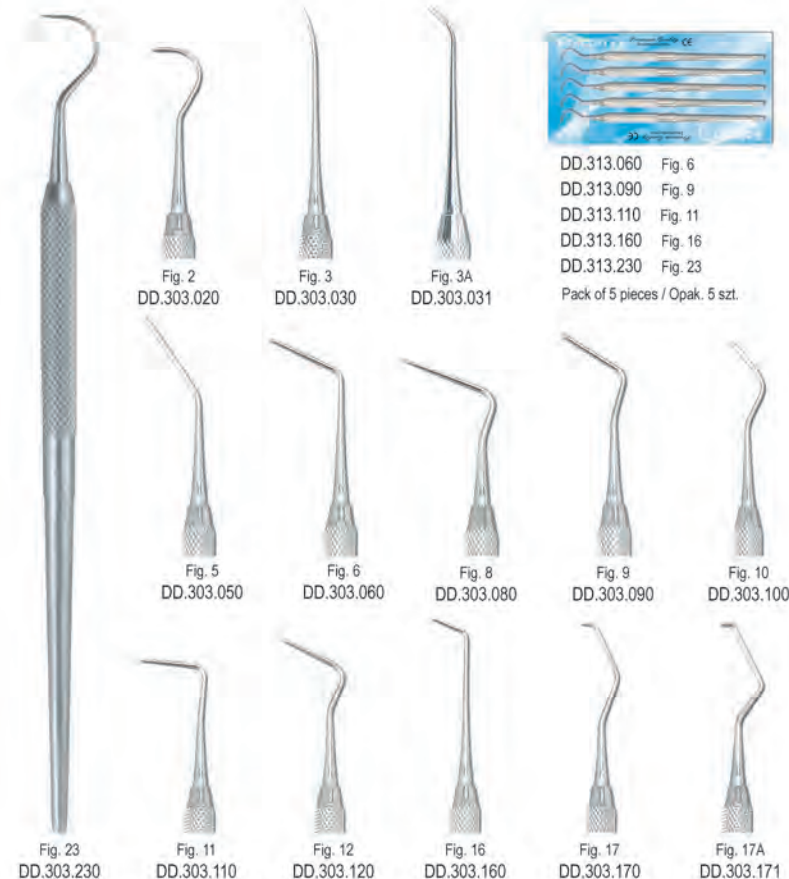

Explorers single ended rigid
Zgłębniki jednostronne twarde

Classic-8
5.5 mm solid handle
5.5 mm pełny uchwyt
BEST SELLER





Periodontal probes
Sondy periodontyczne



6 mm solid handle
6 mm pełny uchwyt

Color-Coded

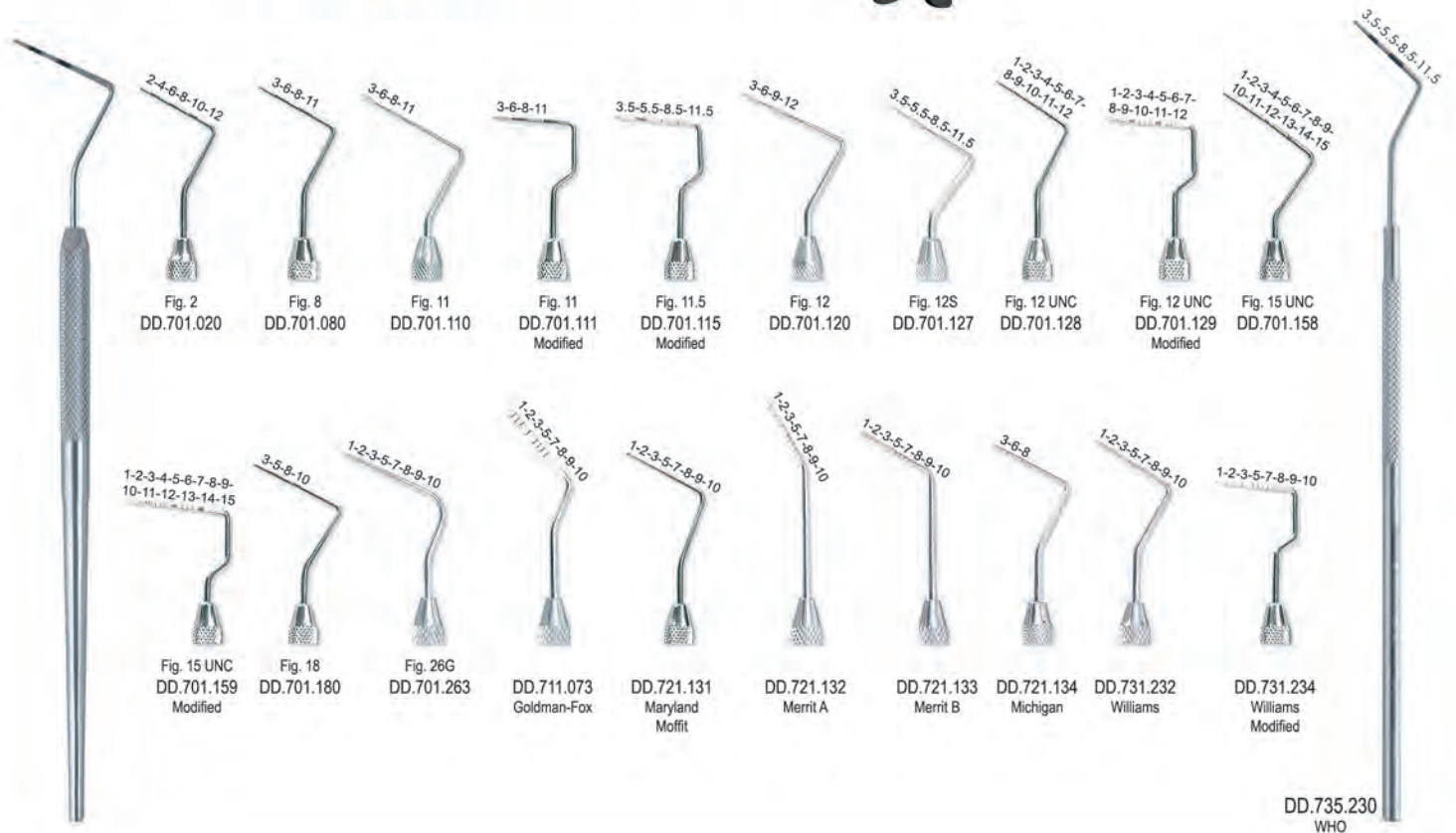

Periodontal probes
Sondy periodontyczne



6 mm solid handle
6 mm pełny uchwyt

Color Coded

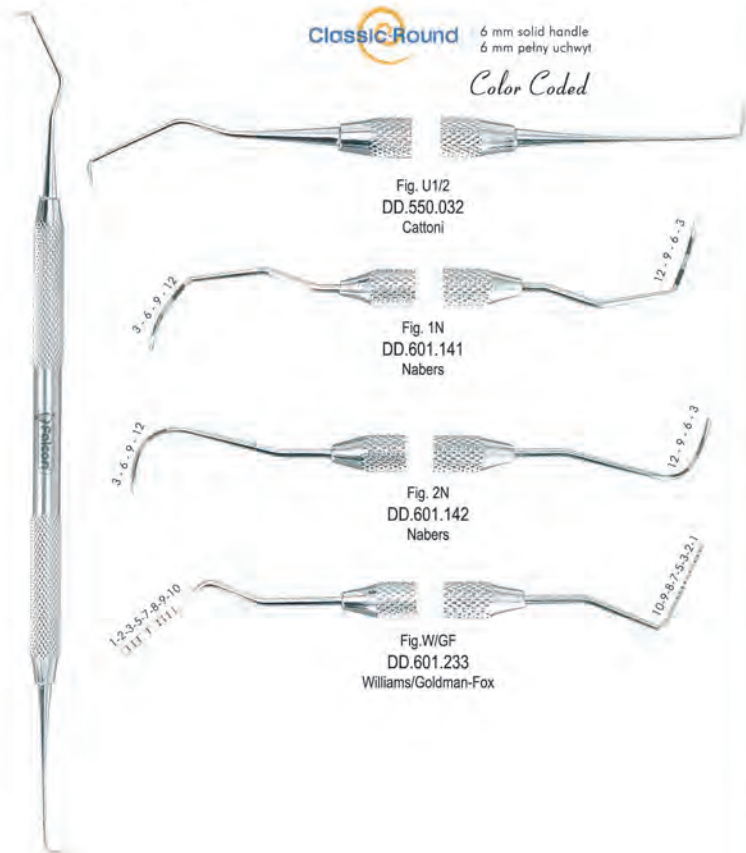

Expros (explorer-probe combination)
Zgłębniki-Sondy



6 mm solid handle
6 mm pełny uchwyt

Color Coded

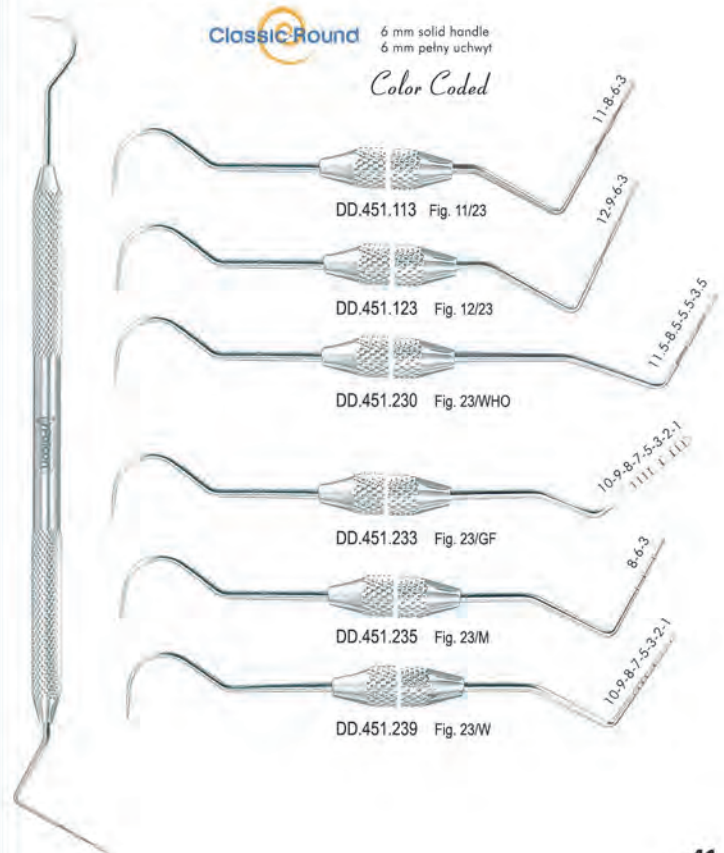



Deluxe tweezers, 18-8 stainless steel
Deluxe pensety ze stali nierdzewnej 18-8

**Titanium
Tytanowe**

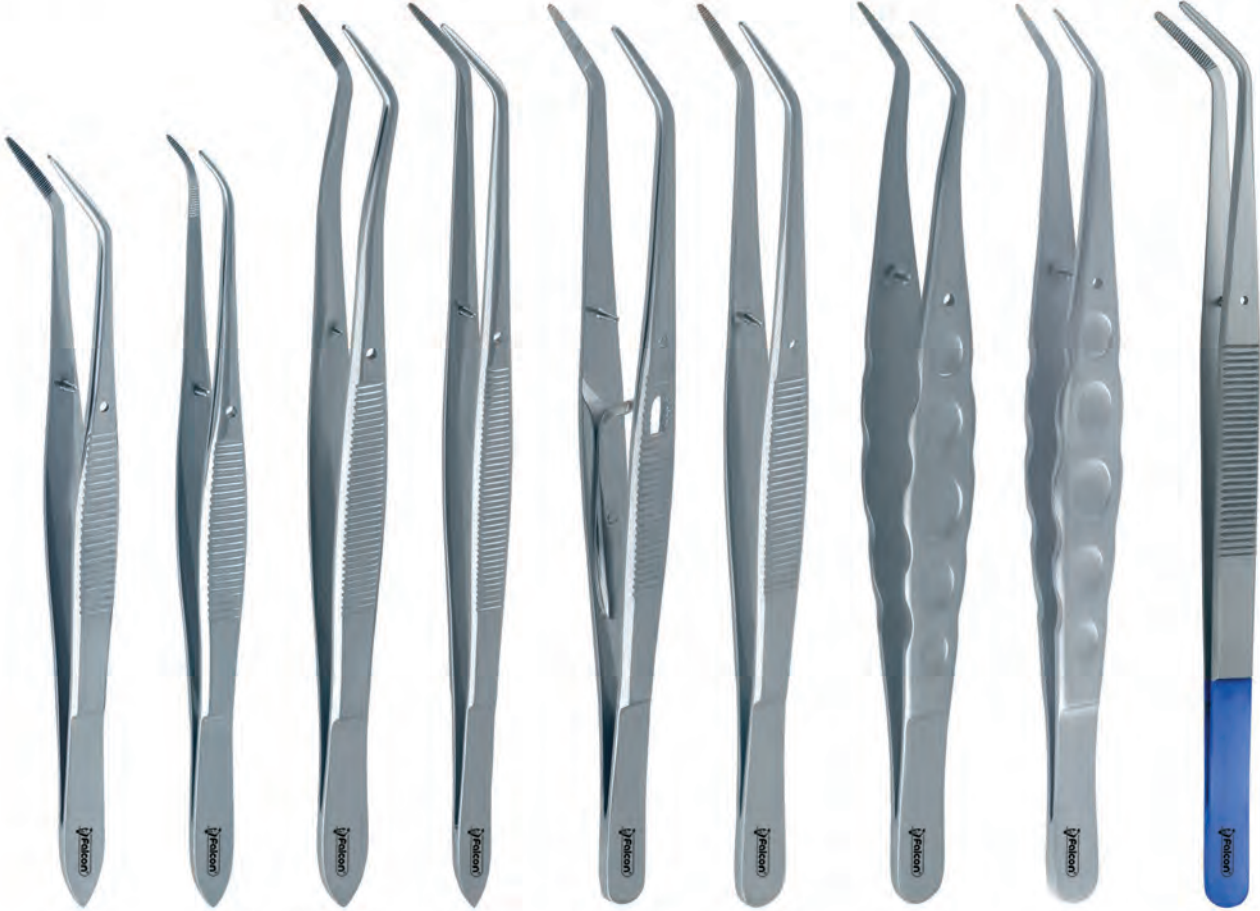

DD.979.130
Perry
130 mm

DD.978.130
Perry
130 mm

DD.944.010
Meriam
160 mm

DD.934.010
Flagg
160 mm

DD.929.050
College Locking
z zamkiem
150mm

DD.909.050
College
150 mm

DD.901.150
Meriam
150 mm

DD.900.150
College
150 mm

DD.890.010
College
150 mm



DD.909.055
College
150 mm
Pack of 5 Pieces
Opak. 5 szt



DD.934.015
Flagg
160 mm
Pack of 5 Pieces
Opak. 5 szt



DD.944.015
Meriam
160 mm
Pack of 5 Pieces
Opak. 5 szt





Autoclavable
Możliwość sterylizacji w autoklawie

Tweezers
Pensety



DD.980.130
Perry
150mm

DD.945.010
Meriam
160mm

DD.935.010
Flagg
160mm

DD.920.010
College Fig. 8
150mm

DD.930.050
College - Locking
z zamkiem
150mm

DD.910.050
College
150mm

DD.926.050
College - Modified
150mm

DD.906.050
College - Ergo
165mm

DD.882.020
College - DP2
165mm



DD.947.010
Meriam - 318
150mm

DD.948.010
Meriam - Modified
150mm

DD.941.010
Meriam - Ergo
165mm

DD.882.030
Meriam - DP3
165mm

TOE Joint
Easy to clean
Łatwość czyszczenia



DD.946.010
Meriam TOE
160mm

DD.911.050
College TOE
150mm

Serie-UNO
Economical dental instruments
Instrumenty stomatologiczne
w atrakcyjnej cenie

Pack of 5 pieces / Opak. 5 szt.



DX.190.010
College
150mm

**Diagnostic sets
Zestawy diagnostyczne**

DD.998.230
Contents

DD.526.020	Soft-Line Mirror handle (Olive)
DD.515.040	Mouth mirror front surface 22mm fig. 4
DD.304.230	Soft-Line Explorer se rigid fig. 23
DD.909.150	Deluxe Tweezers Ergonomic College 150mm

Zawiera

DD.526.020	Soft-Line Uchwyt do lusterka (oliwkowy)
DD.515.040	Lusterko przedniopowierzchniowe 22mm fig. 4
DD.304.230	Soft-Line Zgłębnik jednostronny twardy fig. 23
DD.909.150	Deluxe penseta ergonomiczna College 150mm

DD.996.230
Contents

DD.522.020	Mirror handle solid round
DD.509.040	Mirrors plane ø 22mm fig. 4
DD.201.230	Classic-Round Explorer se flexible fig. 23
DD.909.050	Deluxe Tweezers College 150mm

Zawiera

DD.522.020	Uchwyt do lusterka okrągły
DD.509.040	Lusterka płaskie ø 22mm fig. 4
DD.201.230	Classic-Round Zgłębnik jednostronny miękki fig. 23
DD.909.050	Deluxe penseta College 150mm

DD.996.090
Contents

DD.522.020	Mirror handle solid round
DD.509.040	Mirrors plane ø 22mm fig. 4
DD.201.090	Classic-Round Explorer se flexible fig. 9
DD.909.050	Deluxe Tweezers College 150mm

Zawiera

DD.522.020	Uchwyt do lusterka okrągły
DD.509.040	Lusterka płaskie ø 22mm fig. 4
DD.201.090	Classic-Round Zgłębnik jednostronny miękki fig. 9
DD.909.050	Deluxe penseta College 150mm

DD.996.061
Contents

DD.522.020	Mirror handle solid round
DD.509.040	Mirrors plane ø 22mm fig. 4
DD.201.061	Classic-Round Explorer se flexible fig. 6A
DD.909.050	Deluxe Tweezers College 150mm

Zawiera

DD.522.020	Uchwyt do lusterka okrągły
DD.509.040	Lusterka płaskie ø 22mm fig. 4
DD.201.061	Classic-Round Zgłębnik jednostronny miękki fig. 6A
DD.909.050	Deluxe penseta College 150mm

DD.997.230
Contents

DD.522.020	Mirror handle solid round
DD.509.040	Mirrors plane ø 22mm fig. 4
DD.303.230	Classic-Round Explorer se rigid fig. 23
DD.909.050	Deluxe Tweezers College 150mm

Zawiera

DD.522.020	Uchwyt do lusterka okrągły
DD.509.040	Lusterka płaskie ø 22mm fig. 4
DD.303.230	Classic-Round Zgłębnik jednostronny twardy fig. 23
DD.909.050	Deluxe penseta College 150mm

DD.997.090
Contents

DD.522.020	Mirror handle solid round
DD.509.040	Mirrors plane ø 22mm fig. 4
DD.303.090	Classic-Round Explorer se rigid fig. 9
DD.909.050	Deluxe Tweezers College 150mm

Zawiera

DD.522.020	Uchwyt do lusterka okrągły
DD.509.040	Lusterka płaskie ø 22mm fig. 4
DD.303.090	Classic-Round Zgłębnik jednostronny twardy fig. 9
DD.909.050	Deluxe penseta College 150mm

DD.997.060
Contents

DD.522.020	Mirror handle solid round
DD.509.040	Mirrors plane ø 22mm fig. 4
DD.303.060	Classic-Round Explorer se rigid fig. 6
DD.909.050	Deluxe Tweezers College 150mm

Zawiera

DD.522.020	Uchwyt do lusterka okrągły
DD.509.040	Lusterka płaskie ø 22mm fig. 4
DD.303.060	Classic-Round Zgłębnik jednostronny twardy fig. 6
DD.909.050	Deluxe penseta College 150mm

D6

Periodontal / Periodontologia





**Gracey Curettes
Kirety Gracey**

- Ergonomic, large diameter silicone handle for better grip
- Ultra light weight
- Special grade stainless steel tips ensure longer life
- Rigid pattern, thicker tips than standard Gracey
- Lepsza kontrola dzięki ergonomicznemu, szerszemu uchwytowi z silikonu
- Bardzo lekkie
- Końcówki wykonane z wysokiej jakości stali nierdzewnej zapewniają dłuższe użytkowanie
- Twarde kirety mają szersze końcówki od standardowych kiret Gracey

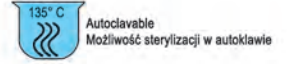

<p>Fig. 1/2 DP.156.021 rigid / twarda Grey / Szara</p>		<p>Anterior teeth Zęby przednie</p>
<p>Fig. 3/4 DP.156.041 rigid / twarda Black / Czarna</p>		<p>Anterior teeth Zęby przednie</p>
<p>Fig. 5/6 DP.156.061 rigid / twarda Yellow / Żółta</p>		<p>Anterior and Premolars Zęby przednie i przedtrzonowe</p>
<p>Fig. 7/8 DP.156.081 rigid / twarda Green / Zielona</p>		<p>Premolars and Molars Zęby przedtrzonowe i trzonowe</p>
<p>Fig. 9/10 DP.156.101 rigid / twarda Red / Czerwona</p>		<p>Molars buccal and lingual surfaces Powierzchnia policzkowa i podniebienna / językowa trzonowców</p>
<p>Fig. 11/12 DP.156.111 rigid / twarda Orange / Pomarańczowa</p>		<p>Posterior mesial surfaces Powierzchnie meżalne trzonowców</p>
<p>Fig. 13/14 DP.156.141 rigid / twarda Blue / Niebieska</p>		<p>Posterior distal surfaces Powierzchnie dystalne trzonowców</p>



DP.156.000
rigid / twarda
Set of 7 pieces / Zestaw 7 szt.



Easy
COLOR

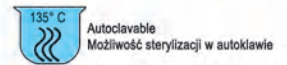

Gracey Curettes
Kirety Gracey

- Ergonomic, large diameter silicone handle for better grip
- Ultra light weight
- Special grade stainless steel tips ensure longer life
- Rigid pattern, thicker tips than standard Gracey
- Lepsza kontrola dzięki ergonomicznemu, szerszemu uchwytowi z silikonu
- Bardzo lekkie
- Końcówki wykonane z wysokiej jakości stali nierdzewnej zapewniają dłuższe użytkowanie
- Twarde kirety mają szersze końcówki od standardowych kiret Gracey

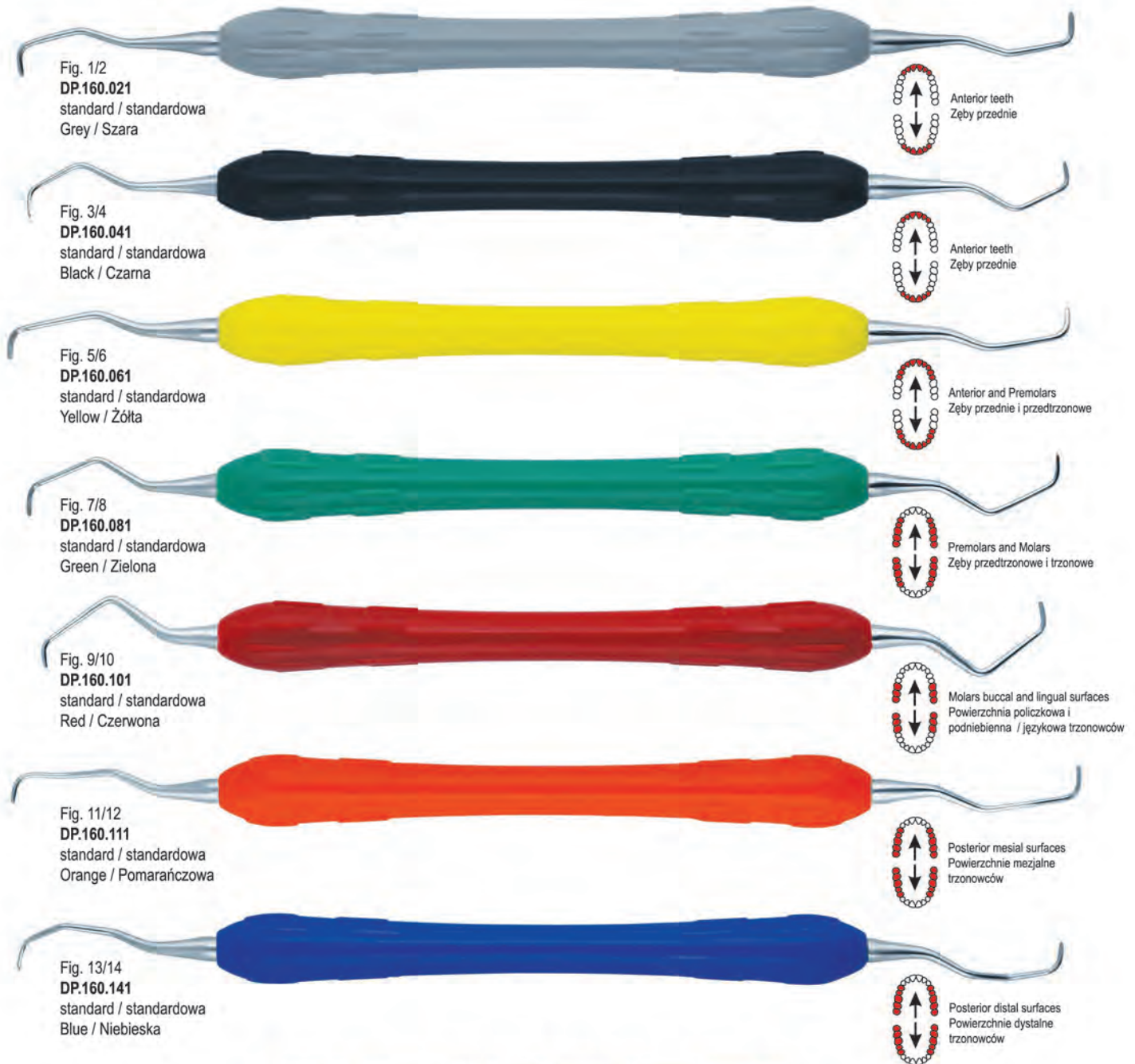

DP.999.011
standard / standardowa
Set of 7 pieces / Zestaw 7 szt.



**Gracey curettes
Kirety Gracey**

Classic Round 6 mm solid handle
6 mm pełny uchwyt



Fig. 1/2
DP.160.020



Fig. 3/4
DP.160.040



Fig. 5/6
DP.160.060



Fig. 7/8
DP.160.080



Fig. 9/10
DP.160.100

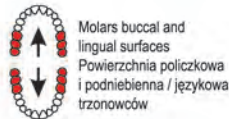

Fig. 11/12
DP.160.110

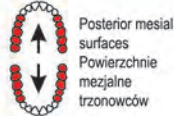
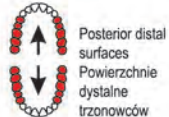

Fig. 13/14
DP.160.140



DP.999.015
Set of 7 pieces
Zestaw 7 szt.



Gracey curettes
Kirety Gracey

CLASSIC-LITE 10 mm hollow handle
10 mm pusty uchwyt



Fig. 1/2
DP.160.025



Fig. 3/4
DP.160.045



Fig. 5/6
DP.160.065

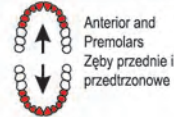

Fig. 7/8
DP.160.085



Fig. 9/10
DP.160.105

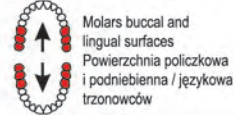

Fig. 11/12
DP.160.115

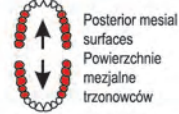
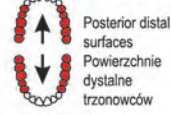

Fig. 13/14
DP.160.145



DP.999.020
Set of 7 pieces
Zestaw 7 szt.



**Universal curettes
Kirety uniwersalne**

Classic-Round 6 mm solid handle
6 mm pełny uchwyt

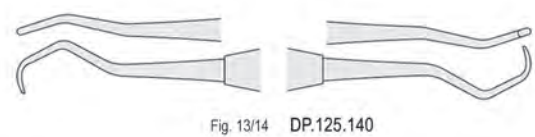
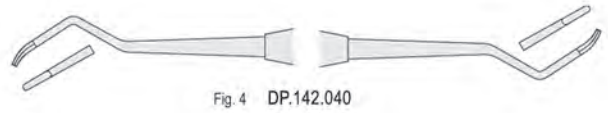

CLASSIC-LITE 10 mm hollow handle
10 mm pusty uchwyt

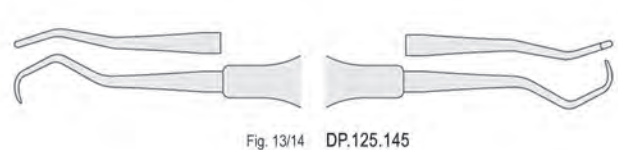
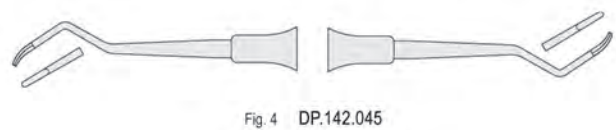
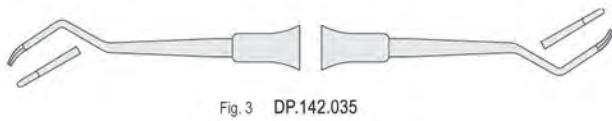

Hoes / Skrobaczki

With tungsten carbide tips
Z końcówką z węgliką spiekanego

CLASSIC-LITE 10 mm hollow handle
10 mm pusty uchwyt



Fig. 6/7 DP.375.075 McFarlane



Fig. 8/9 DP.375.095 McFarlane

Hoes / Skrobaczki

CLASSIC-LITE 10 mm hollow handle
10 mm pusty uchwyt

Goldman-Fox



Fig. 5 DP.365.055



Fig. 6 DP.365.065

Classic-Round 6 mm solid handle
6 mm pełny uchwyt

Goldman-Fox



Fig. 5 DP.365.050



Fig. 6 DP.365.060

Chisels / Dłuta

Classic-Round 6 mm solid handle
6 mm pełny uchwyt



Fig. 1 DP.085.013 TG



Fig. 2 DP.085.023 TG



SOFT LINE INSTRUMENTS
soft and sure grip



Autoclavable
Możliwość sterylizacji w autoklawie

**Scalers
Sierpy**

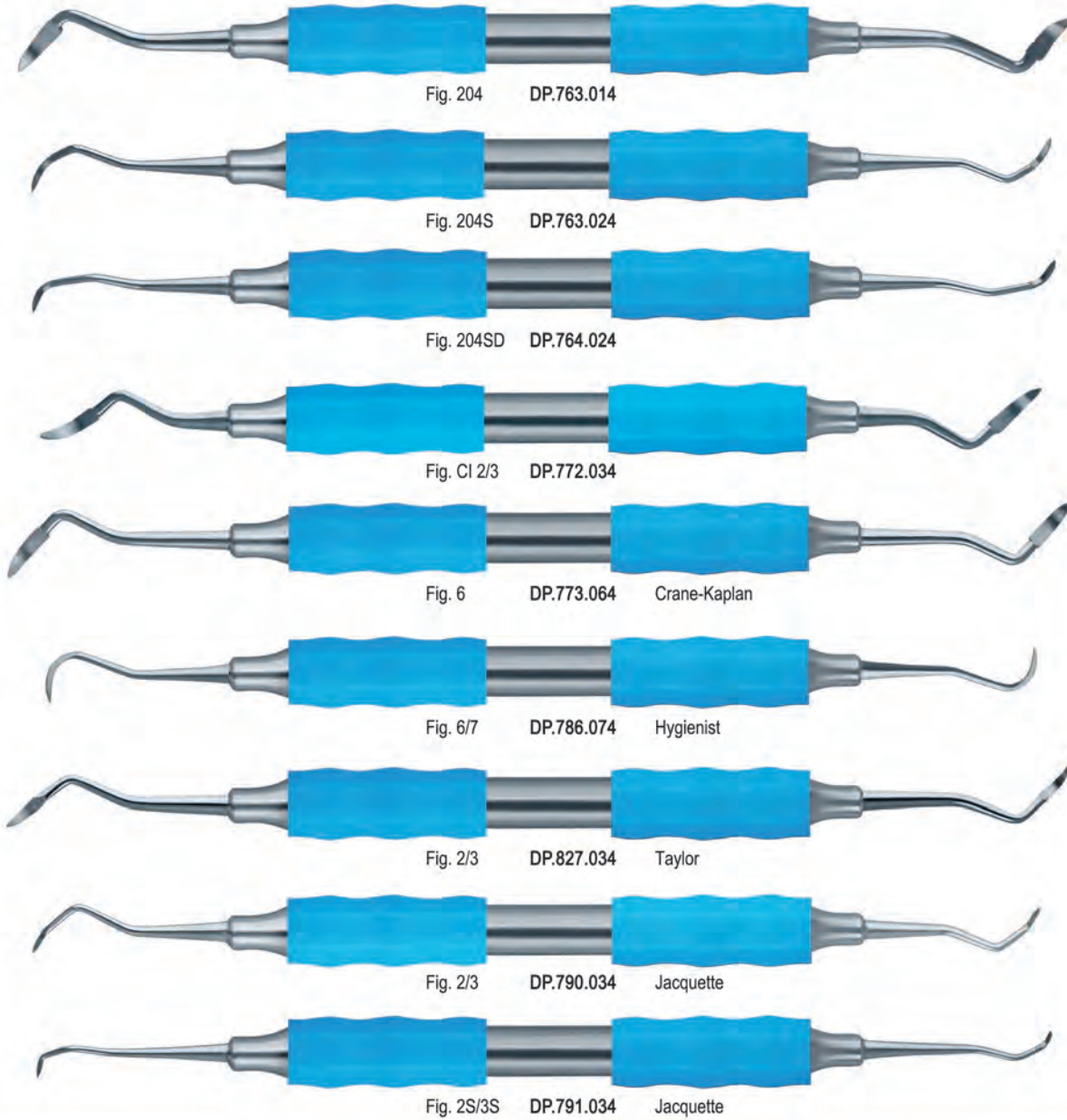

**Scalers
Sierpy**

**Easy
COLOR**



Autoclavable
Możliwość sterylizacji w autoklawie



● **ClassicRound** 6 mm solid handle
6 mm pełny uchwyt

**Scalers
Sierpy**

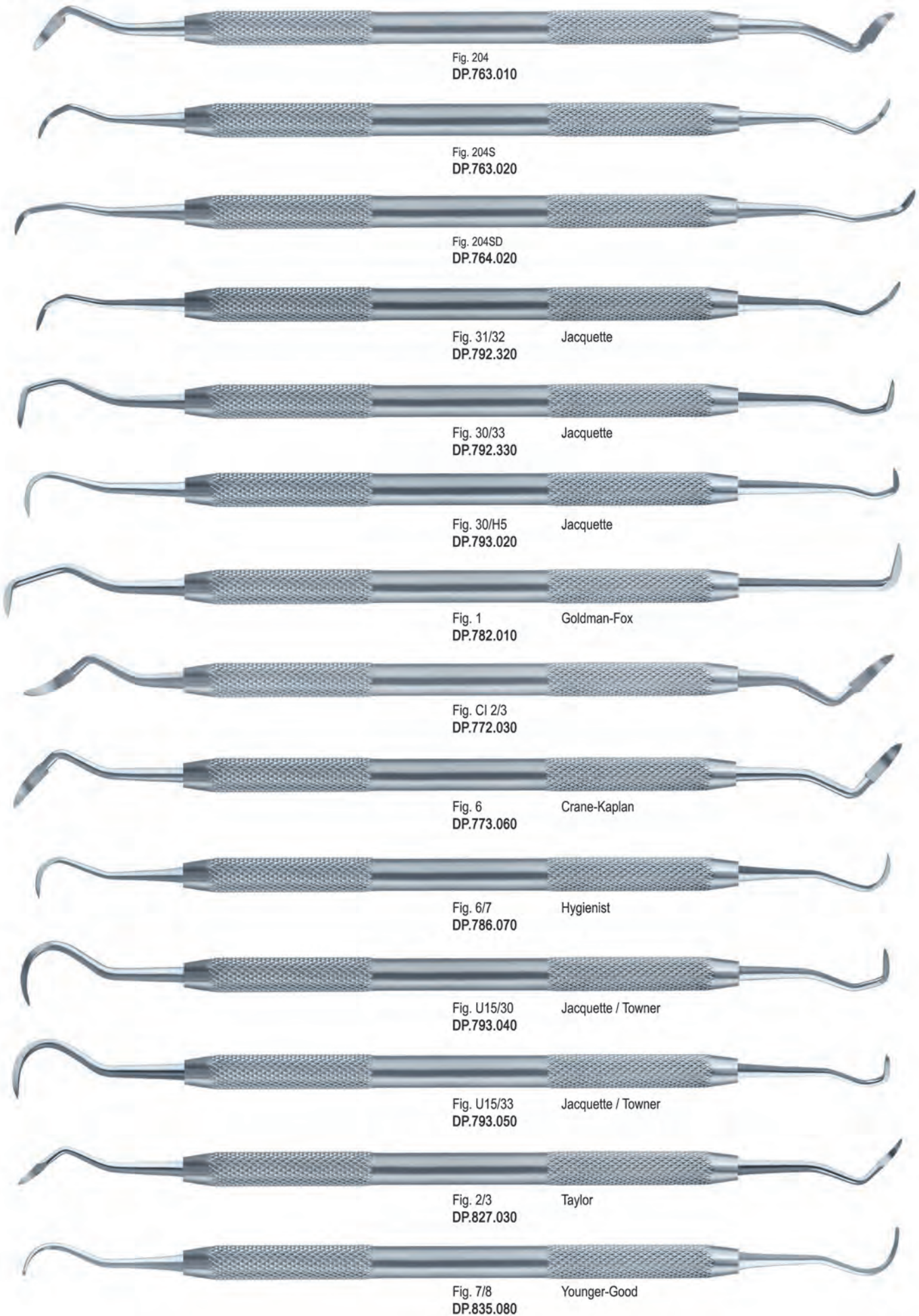



Scalers
Sierpy



Fig. 204
DP.763.015



Fig. 204S
DP.763.025



Fig. 204SD
DP.764.025



Fig. 31/32
DP.792.325
Jacquette



Fig. 30/33
DP.792.335
Jacquette



Fig. 30/H5
DP.793.025
Jacquette



Fig. 1
DP.782.015
Goldman-Fox



Fig. CI 2/3
DP.772.035



Fig. 6
DP.773.065
Crane-Kaplan



Fig. 6/7
DP.786.075
Hygienist

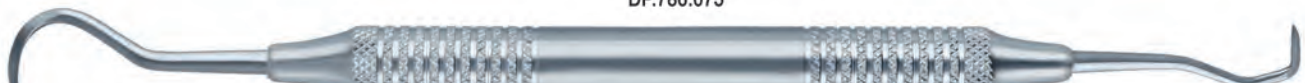

Fig. U15/30
DP.793.045
Jacquette / Towner



Fig. U15/33
DP.793.055
Jacquette / Towner

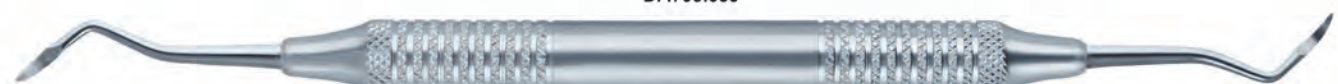

Fig. 2/3
DP.827.035
Taylor

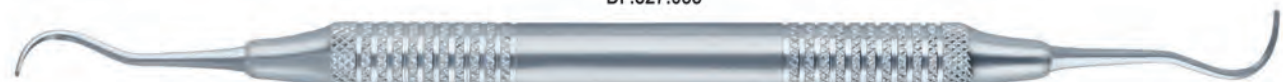

Fig. 7/8
DP.835.085
Younger-Good

Classic-8 5.5 mm solid handle
5,5 mm pełny uchwyt

**Scalers
Sierpy**



Darby Perry

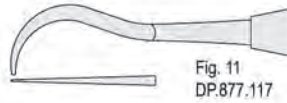

Standard



Standard



Falcon Polska

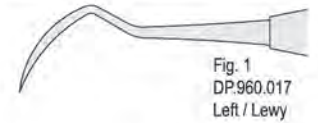

Hygienist

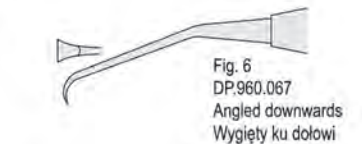
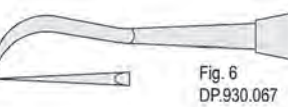
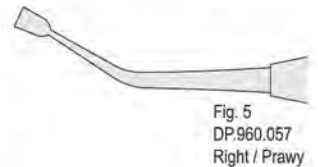
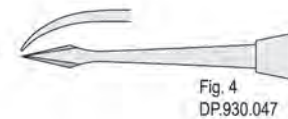
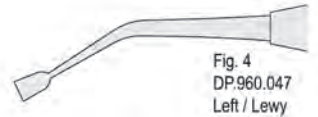
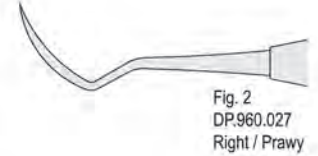
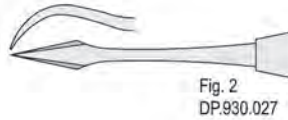

Jacquette



Towner



**Scalers
Sierpy**

CLASSIC-LITE 10 mm hollow handle
10 mm pusty uchwyt



Hygienist



Jacquette



Standard



Standard



Towner



PERIOTOMES

Periotomes are dental instruments used to cut periodontal ligaments for atraumatic tooth extractions and dental implant placement. They have thin sharp blades to facilitate the removal of teeth with minimal damage to surrounding alveolar bone

CLASSIC-LITE



Fig.1 DP.690.015



Fig.2 DP.690.025



Fig.3 DP.690.035

Ergo - form periotome kit / Ergo - form zestaw Periotomów Rękojeść z 4 ostrzami



DP.698.000
Kit with 4 tips / Zestaw z 4 ostrzami



Fig.1 DP.698.010



Fig.2 DP.698.020



Fig.3 DP.698.030



Fig.4 DP.698.040



DP.698.001
Handle / Rękojeść

D7

Endodontics / Endodoncja

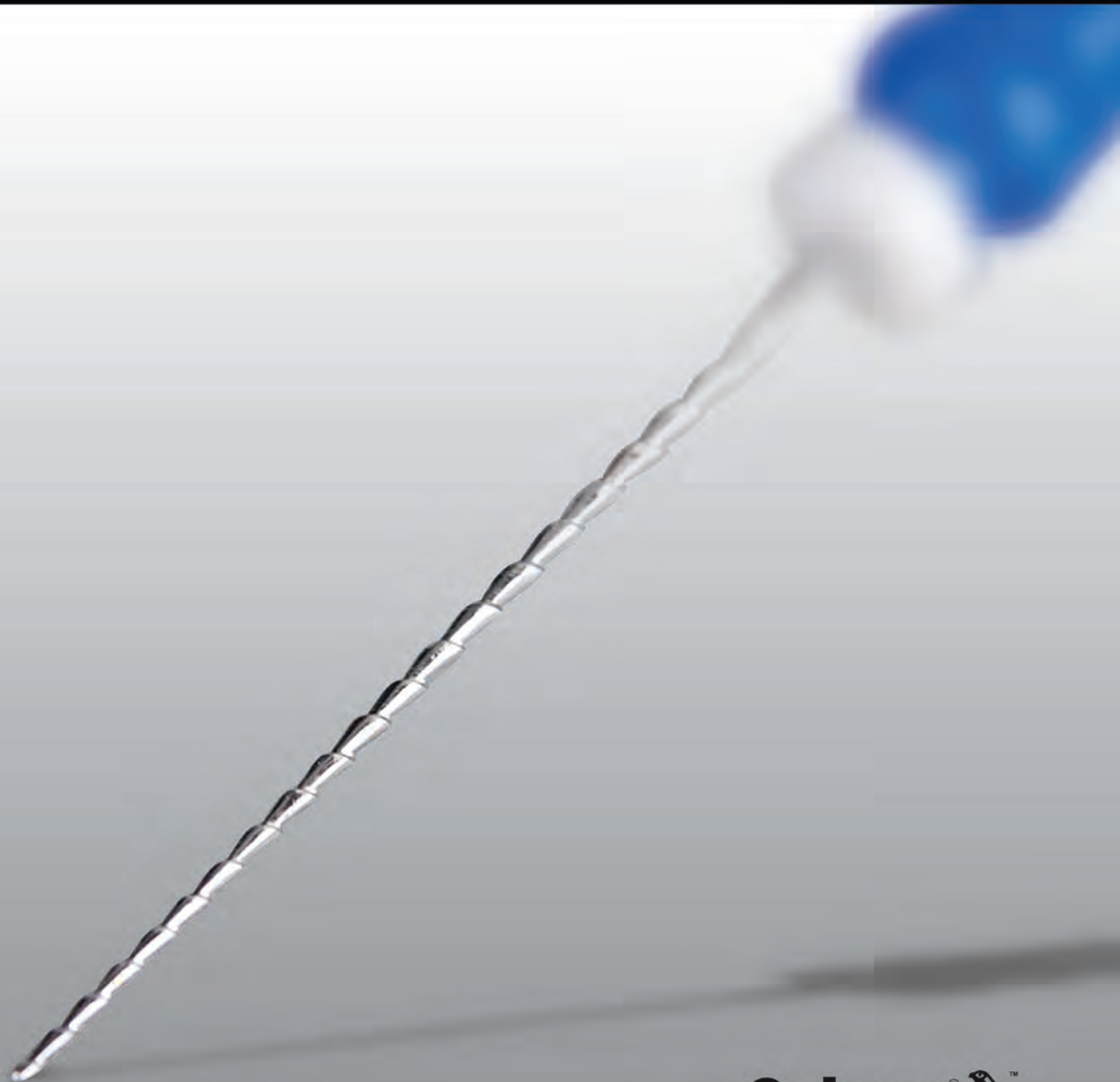

Polycarbonate temporary crowns / Tymczasowe korony



PP003/3404
Polycarbonate crowns kit 180 pieces
Tymczasowe korony, asortyment 180 szt.

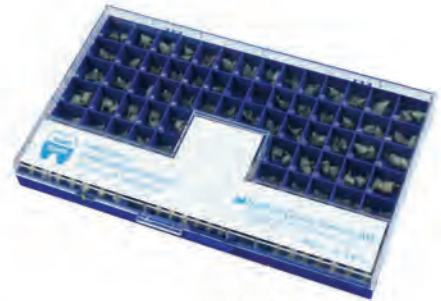

Pack of 5 Pieces
Opak. zawiera 5 szt.

Upper central incisors
Siekacze górne, centralne



Upper lateral incisors
Siekacze górne, boczne



Upper canines / Kły



Premolars / Przedtrzonowce

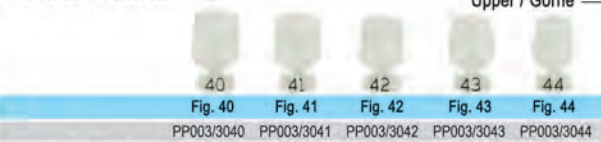

Lower incisors / Siekacze dolne

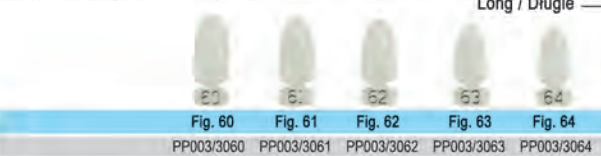

Left / Lewe

Right / Prawe

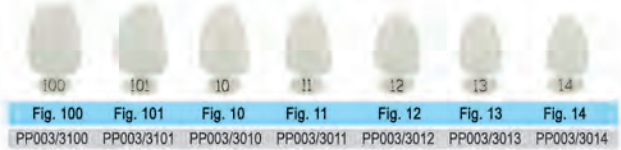

Upper / Górne

Lower / Dolne



Long / Długie

Short / Krótkie



Gold screw posts / Wkłady koronowo-korzeniowe



PP012/3001
Assorted kit 240 pieces
Asortyment 240 szt.

PP012/3000
Assorted kit 60 pieces
Asortyment 60 szt.

Short / Krótkie	S1	S2	S3	S4	S5	S6
	PP012/3002	PP012/3003	PP012/3004	PP012/3005	PP012/3006	PP012/3007

Medium / Średnie	M1	M2	M3	M4	M5	M6
	PP012/3008	PP012/3009	PP012/3010	PP012/3011	PP012/3012	PP012/3013

Long / Długie	L1	L2	L3	L4	L5	L6
	PP012/3014	PP012/3015	PP012/3016	PP012/3017	PP012/3018	PP012/3019

Pack of 12 Pieces
Opak. zawiera 12 szt.

Keys / Klucze



PP012/0001
female / nasadowy
PP012/0002
male / krzyżowy

Reamers / Poszerzacze



DR.5300.00	Short / Krótkie	28mm
DR.5300.01	Long / Długie	34mm

Pack of 6 pieces assorted size 1-6
Opak. sortowane zawiera 6 szt.
w różnych rozmiarach



Autoclavable
Możliwość sterylizacji w autoklawie



Niti Hedstorm files
Pilniki Niti typu Hedstorm



Pack of 6 pcs. / 6 szt. w opak.



Niti K- files
Pilniki Niti typu K



Pack of 6 pcs. / 6 szt. w opak.

ISO Color / No	21 mm	25 mm	28 mm	31 mm
08	DR.3111.08	DR.3112.08	DR.3113.08	DR.3114.08
10	DR.3111.10	DR.3112.10	DR.3113.10	DR.3114.10
15	DR.3111.15	DR.3112.15	DR.3113.15	DR.3114.15
20	DR.3111.20	DR.3112.20	DR.3113.20	DR.3114.20
25	DR.3111.25	DR.3112.25	DR.3113.25	DR.3114.25
30	DR.3111.30	DR.3112.30	DR.3113.30	DR.3114.30
35	DR.3111.35	DR.3112.35	DR.3113.35	DR.3114.35
40	DR.3111.40	DR.3112.40	DR.3113.40	DR.3114.40
45	DR.3111.45	DR.3112.45	DR.3113.45	DR.3114.45
50	DR.3111.50	DR.3112.50	DR.3113.50	X
55	DR.3111.55	DR.3112.55	DR.3113.55	X
60	DR.3111.60	DR.3112.60	DR.3113.60	X
70	DR.3111.70	DR.3112.70	DR.3113.70	X
80	DR.3111.80	DR.3112.80	DR.3113.80	X
Assorted (6 pcs/pack) / Różne (6szt.w opak.)				
15 - 40	DR.3111.00	DR.3112.00	DR.3113.00	DR.3114.00
45 - 80	DR.3111.01	DR.3112.01	DR.3113.01	DR.3114.01

ISO Color / No	21 mm	25 mm	28 mm	31 mm
08	DR.3101.08	DR.3102.08	DR.3103.08	DR.3104.08
10	DR.3101.10	DR.3102.10	DR.3103.10	DR.3104.10
15	DR.3101.15	DR.3102.15	DR.3103.15	DR.3104.15
20	DR.3101.20	DR.3102.20	DR.3103.20	DR.3104.20
25	DR.3101.25	DR.3102.25	DR.3103.25	DR.3104.25
30	DR.3101.30	DR.3102.30	DR.3103.30	DR.3104.30
35	DR.3101.35	DR.3102.35	DR.3103.35	DR.3104.35
40	DR.3101.40	DR.3102.40	DR.3103.40	DR.3104.40
45	DR.3101.45	DR.3102.45	DR.3103.45	DR.3104.45
50	DR.3101.50	DR.3102.50	DR.3103.50	X
55	DR.3101.55	DR.3102.55	DR.3103.55	X
60	DR.3101.60	DR.3102.60	DR.3103.60	X
70	DR.3101.70	DR.3102.70	DR.3103.70	X
80	DR.3101.80	DR.3102.80	DR.3103.80	X
Assorted (6 pcs/pack) / Różne (6szt.w opak.)				
15 - 40	DR.3101.00	DR.3102.00	DR.3103.00	DR.3104.00
45 - 80	DR.3101.01	DR.3102.01	DR.3103.01	DR.3104.01



Stainless steel Hedstorm files
Pilniki stalowe typu Hedstorm



Pack of 6 pcs. / 6 szt. w opak.



Stainless steel K- files
Pilniki stalowe typu K



Pack of 6 pcs. / 6 szt. w opak.

ISO Color / No	21 mm	25 mm	28 mm	31 mm
06	DR.3161.06	DR.3162.06	DR.3163.06	DR.3164.06
08	DR.3161.08	DR.3162.08	DR.3163.08	DR.3164.08
10	DR.3161.10	DR.3162.10	DR.3163.10	DR.3164.10
15	DR.3161.15	DR.3162.15	DR.3163.15	DR.3164.15
20	DR.3161.20	DR.3162.20	DR.3163.20	DR.3164.20
25	DR.3161.25	DR.3162.25	DR.3163.25	DR.3164.25
30	DR.3161.30	DR.3162.30	DR.3163.30	DR.3164.30
35	DR.3161.35	DR.3162.35	DR.3163.35	DR.3164.35
40	DR.3161.40	DR.3162.40	DR.3163.40	DR.3164.40
45	DR.3161.45	DR.3162.45	DR.3163.45	DR.3164.45
50	DR.3161.50	DR.3162.50	DR.3163.50	X
55	DR.3161.55	DR.3162.55	DR.3163.55	X
60	DR.3161.60	DR.3162.60	DR.3163.60	X
70	DR.3161.70	DR.3162.70	DR.3163.70	X
80	DR.3161.80	DR.3162.80	DR.3163.80	X
Assorted (6 pcs/pack) / Różne (6szt.w opak.)				
15 - 40	DR.3161.00	DR.3162.00	DR.3163.00	DR.3164.00
45 - 80	DR.3161.01	DR.3162.01	DR.3163.01	DR.3164.01

ISO Color / No	21 mm	25 mm	28 mm	31 mm
06	DR.3151.06	DR.3152.06	DR.3153.06	DR.3154.06
08	DR.3151.08	DR.3152.08	DR.3153.08	DR.3154.08
10	DR.3151.10	DR.3152.10	DR.3153.10	DR.3154.10
15	DR.3151.15	DR.3152.15	DR.3153.15	DR.3154.15
20	DR.3151.20	DR.3152.20	DR.3153.20	DR.3154.20
25	DR.3151.25	DR.3152.25	DR.3153.25	DR.3154.25
30	DR.3151.30	DR.3152.30	DR.3153.30	DR.3154.30
35	DR.3151.35	DR.3152.35	DR.3153.35	DR.3154.35
40	DR.3151.40	DR.3152.40	DR.3153.40	DR.3154.40
45	DR.3151.45	DR.3152.45	DR.3153.45	DR.3154.45
50	DR.3151.50	DR.3152.50	DR.3153.50	X
55	DR.3151.55	DR.3152.55	DR.3153.55	X
60	DR.3151.60	DR.3152.60	DR.3153.60	X
70	DR.3151.70	DR.3152.70	DR.3153.70	X
80	DR.3151.80	DR.3152.80	DR.3153.80	X
Assorted (6 pcs/pack) / Różne (6szt.w opak.)				
15 - 40	DR.3151.00	DR.3152.00	DR.3153.00	DR.3154.00
45 - 80	DR.3151.01	DR.3152.01	DR.3153.01	DR.3154.01



NiTi Reamers
Poszerzacze NiTi



Pack of 6 pcs. / 6 szt. w opak.

ISO Color / No	21 mm	25 mm	28 mm
10	DR.3121.10	DR.3122.10	DR.3123.10
15	DR.3121.15	DR.3122.15	DR.3123.15
20	DR.3121.20	DR.3122.20	DR.3123.20
25	DR.3121.25	DR.3122.25	DR.3123.25
30	DR.3121.30	DR.3122.30	DR.3123.30
35	DR.3121.35	DR.3122.35	DR.3123.35
40	DR.3121.40	DR.3122.40	DR.3123.40
45	DR.3121.45	DR.3122.45	DR.3123.45
Assorted (6 pcs/pack) / Różne (6szt.w opak.)			
15 - 40	DR.3121.00	DR.3122.00	DR.3123.00



Stainless Steel Reamers
Poszerzacze stalowe



Pack of 6 pcs. / 6 szt. w opak.

ISO Color / No	21 mm	25 mm	28 mm	31 mm
08	DR.3171.08	DR.3172.08	DR.3173.08	DR.3174.08
10	DR.3171.10	DR.3172.10	DR.3173.10	DR.3174.10
15	DR.3171.15	DR.3172.15	DR.3173.15	DR.3174.15
20	DR.3171.20	DR.3172.20	DR.3173.20	DR.3174.20
25	DR.3171.25	DR.3172.25	DR.3173.25	DR.3174.25
30	DR.3171.30	DR.3172.30	DR.3173.30	DR.3174.30
35	DR.3171.35	DR.3172.35	DR.3173.35	DR.3174.35
40	DR.3171.40	DR.3172.40	DR.3173.40	DR.3174.40
45	DR.3171.45	DR.3172.45	DR.3173.45	DR.3174.45
50	DR.3171.50	DR.3172.50	DR.3173.50	DR.3174.50
55	DR.3171.55	DR.3172.55	DR.3173.55	DR.3174.55
60	DR.3171.60	DR.3172.60	DR.3173.60	DR.3174.60
70	DR.3171.70	DR.3172.70	DR.3173.70	DR.3174.70
80	DR.3171.80	DR.3172.80	DR.3173.80	DR.3174.80
Assorted (6 pcs/pack) / Różne (6szt.w opak.)				
15 - 40	DR.3171.00	DR.3172.00	DR.3173.00	DR.3174.00
45 - 80	DR.3171.01	DR.3172.01	DR.3173.01	DR.3174.01



NiTi finger spreaders
Rozpychacze NiTi do gutaperki



Pack of 6 pcs. / 6 szt. w opak.

ISO Color / No	21 mm	25 mm	28 mm
15	DR.3141.15	DR.3142.15	DR.3143.15
20	DR.3141.20	DR.3142.20	DR.3143.20
25	DR.3141.25	DR.3142.25	DR.3143.25
30	DR.3141.30	DR.3142.30	DR.3143.30
35	DR.3141.35	DR.3142.35	DR.3143.35
40	DR.3141.40	DR.3142.40	DR.3143.40
45	DR.3141.45	DR.3142.45	DR.3143.45
Assorted (6 pcs/pack) / Różne (6 szt. w opak.)			
15 - 40	DR.3141.00	DR.3142.00	DR.3143.00



NiTi finger pluggers
Upychadła NiTi do gutaperki



Pack of 6 pcs. / 6 szt. w opak.

ISO Color / No	21 mm	25 mm	28 mm
15	DR.3131.15	DR.3132.15	DR.3133.15
20	DR.3131.20	DR.3132.20	DR.3133.20
25	DR.3131.25	DR.3132.25	DR.3133.25
30	DR.3131.30	DR.3132.30	DR.3133.30
35	DR.3131.35	DR.3132.35	DR.3133.35
40	DR.3131.40	DR.3132.40	DR.3133.40
45	DR.3131.45	DR.3132.45	DR.3133.45
Assorted (6 pcs/pack) / Różne (6 szt. w opak.)			
15 - 40	DR.3131.00	DR.3132.00	DR.3133.00

Stainless Steel Barbed Broach
Miazgociągi stalowe



Pack of 10 pcs. / 10 szt. w opak.

ISO Color / No		21 mm	25 mm
0	XXXXF	DR.4051.10	DR.4052.10
1	XXXF	DR.4051.15	DR.4052.15
2	XXF	DR.4051.20	DR.4052.20
3	XF	DR.4051.25	DR.4052.25
4	F	DR.4051.30	DR.4052.30
5	M	DR.4051.35	DR.4052.35
6	C	DR.4051.40	DR.4052.40
Assorted (10 pcs/pack) / Różne (10 szt.w opak.)			
0-6	XXXXF - C	DR.4051.00	DR.4052.00
2-4	XXXXF - XF	DR.4051.01	DR.4052.01

Stainless Steel paste carriers RA
Igly stalowe do wypełniania kanału



ISO Color / No		21 mm	25 mm
25		DR.5009.25	DR.5010.25
30		DR.5009.30	DR.5010.30
35		DR.5009.35	DR.5010.35
40		DR.5009.40	DR.5010.40
Assorted (4 pcs/pack) / Różne (4 szt.w opak.)			
25-40		DR.5009.00	DR.5010.00

Universal Prot-T Niti rotary files
Pilniki maszynowe Universal Pro-T NiTi

- MaxTech NiTi alloy
- Triangular cross section and safe guiding tip
- Variable taper
- Suitable for regular canal preparation
- Continuous clockwise rotation

- Crown-Down Sequence:
Create straight-line access to canal orifice (SX)
Shape the upper 2/3 of canal, confirm the working length and smooth the root canal (S1, S2)
Shape the apical 1/3 and finish (F1, F2). If necessary, come to F3, F4, F5



Type	SX	S1	S2	F1	F2	F3	F4	F5
Size	019/.04	018/.02	020/.04	020/.07	025/.08	030/.09	040/.06	050/.05
Speed (RPM)	250	250	250	250	250	250	250	250
Torque (N.CM)	3.0	2.0	1.5	1.5	2.0	2.0	2.0	2.0
GP				F1	F2	F3	F4	F5

ISO Color / No	19 mm	21 mm	25 mm	31 mm
SX	SFU 019 0SX			
S1		SFU 021 0S1	SFU 025 0S1	SFU 031 0S1
S2		SFU 021 0S2	SFU 025 0S2	SFU 031 0S2
F1		SFU 021 0F1	SFU 025 0F1	SFU 031 0F1
F2		SFU 021 0F2	SFU 025 0F2	SFU 031 0F2
F3		SFU 021 0F3	SFU 025 0F3	SFU 031 0F3
F4		SFU 021 0F4	SFU 025 0F4	SFU 031 0F4
F5		SFU 021 0F5	SFU 025 0F5	SFU 031 0F5
Assorted (6 pcs/pack) / Różne (6 szt. w opak.)				
SX - F3		SFU 021 A01	SFU 025 A01	SFU 031 A01

Universal Pro-T + Niti rotary files
Pilniki maszynowe Universal Pro-T + NiTi

- MaxTech 3.0 NiTi alloy
- Suitable for bending angle < 15° canal
- Longer fatigue life
- Triangular cross section and safe guiding lip
- Variable taper
- Continuous clockwise rotation

Create straight-line access to canal orifice (SX)

Shape the upper 2/3 of canal, confirm the working length and smooth the root canal (S1, S2)

Shape the apical 1/3 and finish (F1, F2). If necessary, come to F3, F4, F5



Type	SX	S1	S2	F1	F2	F3	F4	F5
Size	019/.04	018/.02	020/.04	020/.07	025/.08	030/.09	040/.06	050/.05
Speed (RPM)	300	300	300	300	300	300	300	300
Torque (N.CM)	3.0	3.0	3.0	3.0	3.0	3.0	3.0	3.0
GP				F1	F2	F3	F4	F5

ISO Color / No	19 mm	21 mm	25 mm	31 mm
SX	AFU 019 0SX			
S1		AFU 021 0S1	AFU 025 0S1	AFU 031 0S1
S2		AFU 021 0S2	AFU 025 0S2	AFU 031 0S2
F1		AFU 021 0F1	AFU 025 0F1	AFU 031 0F1
F2		AFU 021 0F2	AFU 025 0F2	AFU 031 0F2
F3		AFU 021 0F3	AFU 025 0F3	AFU 031 0F3
F4		AFU 021 0F4	AFU 025 0F4	AFU 031 0F4
F5		AFU 021 0F5	AFU 025 0F5	AFU 031 0F5
	Assorted (6 pcs/pack) / Różne (6 szt. w opak.)			
SX - F3		AFU 021 A01	AFU 025 A01	AFU 031 A01

Niti W One files
Pilniki maszynowe W One NiTi

W One is the perfect solution for those wishing to switch from hand files to a rotary based endodontic system.

The reciprocating technology of W One means that it will only shape the canal when pressure is applied, giving you the feeling of complete control

W One also simplifies the procedure, in most cases requiring just one NiTi instrument per root canal treatment.

The Maxtech-Wire Nickel-Titanium technology provides overall flexibility and resistance to cyclic fatigue, the leading cause of file separation.

In fact, the tougher the instrumenting challenge, like shaping severely curved to the apex, the more apparent the Maxtech-Wire NiTi's advantages become.

Pilniki W One to nowy standard w endodoncji, dzięki zapewnieniu prostoty, bezpieczeństwa oraz wydajności.

W większości przypadków proces kształtowania kanałów korzeniowych ogranicza się do zastosowania tylko jednego narzędzia NiTi w każdym kanale.

Pilniki charakteryzują się optymalną wydajnością skrawania, pozwalają na zmniejszenie całkowitego czasu opracowywania kanału nawet o 40%, minimalizują ryzyko wystąpienia efektu wkręcania się lub złamania pilnika.

W One to wysoka elastyczność i zwiększona wytrzymałość na cykliczne zmęczenie materiału. Technika pojedynczego pilnika w ruchu oscylacyjnym.

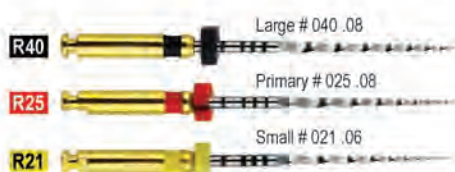

ISO Color / No	21 mm	25 mm	31 mm
R21	SFW 021 021	SFW 021 025	SFW 021 031
R25	SFW 025 021	SFW 025 025	SFW 025 031
R40	SFW 040 021	SFW 040 025	SFW 040 031
	Assorted (6 pcs/pack) / Różne (6 szt. w opak.)		
R21 - R40	SFW 021 A01	SFW 025 A01	SFW 031 A01

Niti W One + files

Pilniki maszynowe W One + NiTi



The single-file simplicity of W One + is now enhanced in W One +. Made with advanced metallurgy, it is the next generation of performance.

- Increases patient safety, while reducing shaping time across a wide range of cases
- Optimized with enhanced design features by leading endodontists
- Part of a complete solution that includes obturation products designed to match the shapes created by W One + files
- The W One + family now includes a single glide path file with reciprocating motion for simplicity from the start



Pilniki W One + został zoptymalizowany w celu zwiększenia wydajności cięcia. One + to krótszy czas kształtowania w stosunku do W One i innych standardowych systemów rotacyjnych NiTi. W większości przypadków (80%) kształtowanie kanału można wykonać jednym pilnikiem.

Pilniki W One + to zwiększone bezpieczeństwo pacjentów:

- o 50% bardziej odporne na cykliczne zmęczenie materiału niż inne pilniki,
 - możliwość zastosowania do kanałów o różnych kształtach dzięki zredukowanemu efektowi wkręcania w porównaniu ze standardowymi systemami obrotowymi (ruch recypokalny)
 - większa elastyczność pilnika
 - rozszerzony zakres rozmiarów (wstępny, podstawowy, średni, szeroki),
 - wyższa efektywność skrawania,
 - oszczędność czasu dzięki procedurze z zastosowaniem tylko jednego pilnika.
- Dostępne opakowanie 3zt. w pojedynczym rozmiarze o długości 21mm / 25mm / 31mm:
- Small #20 (żółty) - wstępny
 - Primary #25 (czerwony) - podstawowy
 - Medium #35 (zielony) - średni
 - Large #45 (biały) - szeroki

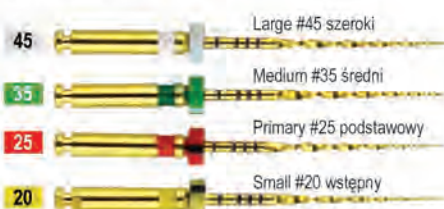

ISO Color / No	21 mm	25 mm	31 mm
20	AFW 021 020	AFW 025 020	AFW 031 020
25	AFW 021 025	AFW 025 025	AFW 031 025
35	AFW 021 035	AFW 025 035	AFW 031 035
45	AFW 021 045	AFW 025 045	AFW 031 045
Assorted (6 pcs/pack) / Różne (6 szt. w opak.)			
20 - 45	AFW 021 A01	AFW 025 A01	AFW 031 A01

Niti V rotary files

Pilniki maszynowe V NiTi



- MaxTech NiTi alloy
- Suitable for narrow curved canal
- Reciprocating
- Regressive taper design to prevent unnecessary loss of tooth substance in the coronal part



System pozwalający na preparację kanału korzeniowego przy pomocy jednego pilnika. Dzięki ruchowi oscylacyjnemu możliwe jest opracowanie kanałów korzeniowych przy użyciu jednego narzędzia. Ruch oscylacyjny zmniejsza naprężenia powstające w obrębie narzędzia, redukując w ten sposób ryzyko zmęczenia materiału wywołanego przez pociąganie i ściskanie. System Reciproc to łatwość zastosowania, bezpieczeństwo i oszczędność czasu.

Pilniki oscylacyjne Reciproc zostały specjalnie zaprojektowane do pracy przy użyciu obrotów „w przód i w tył”. Wytwarzane są one przy użyciu obróbki termicznej ze specjalnego materiału NiTi - "MaxTech". Materiał ten zapewnia zarówno większą wytrzymałość jak i elastyczność w porównaniu do dotychczasowych instrumentów NiTi. Dodatkową zaletą nowego kształtu jest wysoka zdolność do odprowadzenia zebranej zębiny z kanału.

Dostępne rodzaje:

- R25 (czerwony) - dla większości kanałów
- R40 (czarny) - dla kanałów średnio-szerokich, większych niż ISO 20
- R50 (żółty) - dla kanałów szerokich, większych niż ISO 30
- Ass. R40-R50



ISO Color / No	21 mm	25 mm	31 mm
R25	SFV 021 025	SFV 025 025	SFV 031 025
R40	SFV 021 040	SFV 025 040	SFV 031 040
R50	SFV 021 050	SFV 025 050	SFV 031 050
Assorted (6 pcs/pack) / Różne (6 szt. w opak.)			
R25 - R50	SFV 021 A01	SFV 025 A01	SFV 031 A01

Niti V Blue rotary files
Pilniki maszynowe V Blue NiTi



Simple, but effective: The new V blue file generation combines the ease of the original Reciproc one file endo concept with enhanced safety in root canal preparation and retreatment for patients. An innovative heat treatment makes RECIPROC blue particularly flexible to ensure a smoother and safer progression in the canal.

V blue files are produced with Nickel-Titanium (NiTi) that goes through an innovative heat treatment, modifying its molecular structure to give it increased resistance to cyclic fatigue and additional flexibility as well as its characteristic blue color.

The shape obtained by the V blue instrument enables effective irrigation and obturation with both cold and warm techniques.



Instrumenty V Blue o zwiększonej do 40% elastyczności oraz o ponad 2-krotnie większej wytrzymałości na złamanie w porównaniu z instrumentami Reciproc pozwalają na opracowanie całego kanału korzeniowego, zwłaszcza zakrzywionego, tylko jednym pilnikiem, przy zastosowaniu łatwej do nauki, prostej procedury. Opracowany kanał można następnie wypełnić przy zastosowaniu zarówno techniki kondensacji gutaperki na gorąco jak i na zimno. Instrumenty do systemu V Blue zostały specjalnie zaprojektowane do pracy przy użyciu obrotów „w przód i w tył”. Wytwarzane są one ze specjalnego materiału NiTi – “M-Wire”, zapewniającego zarówno większą wytrzymałość jak i elastyczność w porównaniu do dotychczasowych instrumentów NiTi. Pilniki V Blue przeznaczone są do jednorazowego użycia, zapewniając maksymalną wygodę i bezpieczeństwo.

Zalety:

- Lepsze, bardziej osiowe, prowadzenie w kanale - nie ma konieczności wstępnego opracowania kanału pilnikami ręcznymi
- Łatwość pracy - elastyczny pilnik o pasywnej końcówce
- Prostota użycia - mniej kroków w procedurze zmniejsza możliwość popełnienia błędu
- Krótsza procedura - wystarczy wybór jednego pilnika
- Oszczędność czasu - nie ma czyszczenia i sterylizacji instrumentów po użyciu

Dostępne rodzaje:

- R25 (czerwony) - odpowiedni dla kanałów wąskich
- R40 (czarny) - dla kanałów średnio-szerokich
- R50 (żółty) - dla kanałów bardzo szerokich



ISO Color / No	21 mm	25 mm	31 mm
R25	BFV 021 025	BFV 025 025	BFV 031 025
R40	BFV 021 040	BFV 025 040	BFV 031 040
R50	BFV 021 050	BFV 025 050	BFV 031 050
Assorted (6 pcs/pack) / Różne (6 szt. w opak.)			
R25 - R50	BFV 021 A01	BFV 025 A01	BFV 031 A01

Stainless Steel reamers RA
Poszerzaczce stalowe na kątnice



Reamers Gates Glidden / Poszerzaczce Gates Glidden

Ø mm 0.50 0.70 0.90 1.10 1.30 1.50



Pack of 6 pieces / Opak. 6 szt.

Długość 28 mm

Size / Rozmiar	Code / Kod
1	DR.5100.01
2	DR.5100.02
3	DR.5100.03
4	DR.5100.04
5	DR.5100.05
6	DR.5100.06
Assorted (6 pcs/pack) / Różne (6 szt. w opak.)	
1 - 6	DR.5100.00

Reamers Peeso / Poszerzaczce Peeso

Ø mm 0.70 0.90 1.10 1.30 1.50 1.70



Pack of 6 pieces / Opak. 6 szt.

Długość 28 mm

Size / Rozmiar	Code / Kod
1	DR.5200.01
2	DR.5200.02
3	DR.5200.03
4	DR.5200.04
5	DR.5200.05
6	DR.5200.06
Assorted (6 pcs/pack) / Różne (6 szt. w opak.)	
1 - 6	DR.5200.00

Endodontic Excavators
Ekskawatory endodontyczne

Classic-8 5.5 mm solid handle / 5.5 mm pełny uchwyt

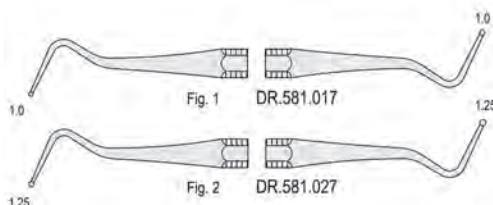

Fig. 1 DR.581.017

Fig. 2 DR.581.027

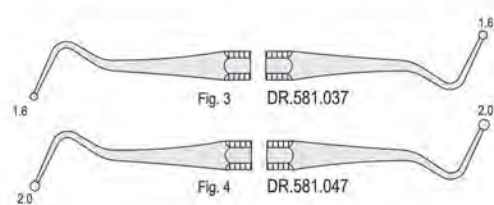

Fig. 3 DR.581.037

Fig. 4 DR.581.047

Endodontic explorers
Zgłębniki endodontyczne

135° C
Autoclavable
Możliwość sterylizacji w autoklawie

SOFT LINE INSTRUMENTS
soft and sure grip



Fig. 1 DR.584.014

Fig. DG16 DR.584.164

Classic-Found 6 mm solid handle
6 mm pełny uchwyt

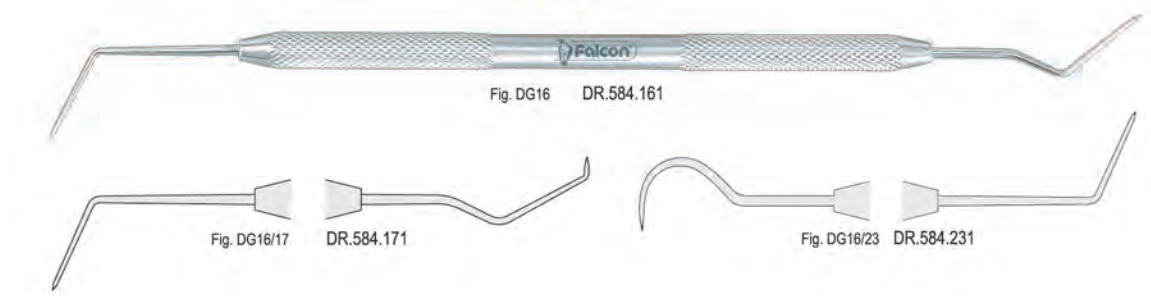

Fig. DG16 DR.584.161

Fig. DG16/17 DR.584.171

Fig. DG16/23 DR.584.231

Endodontic excavators
Ekskawatory endodontyczne

135° C
Autoclavable
Możliwość sterylizacji w autoklawie

Classic-Found 6 mm solid handle
6 mm pełny uchwyt

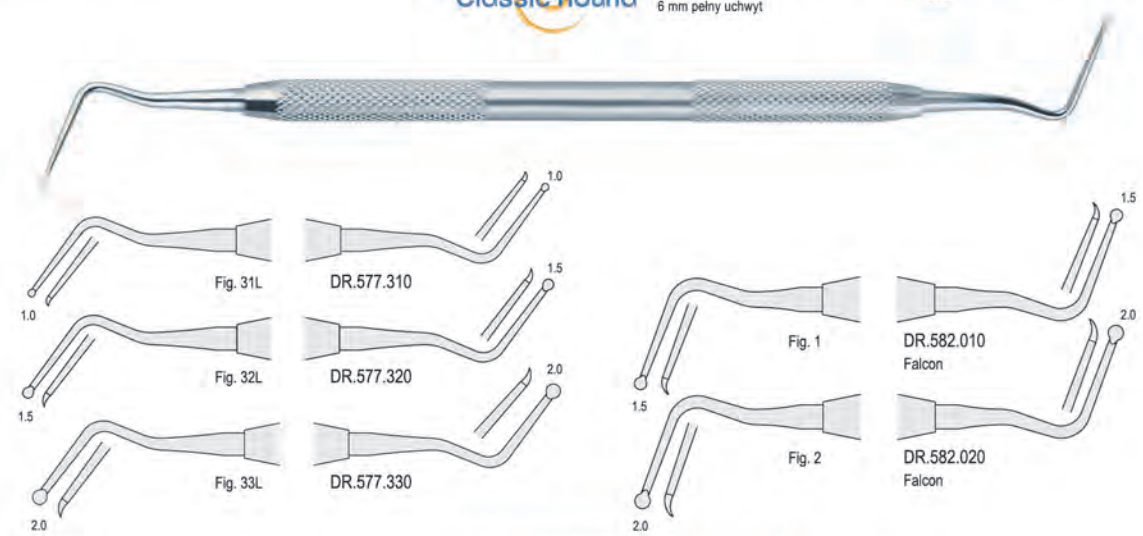

Fig. 31L DR.577.310

Fig. 32L DR.577.320

Fig. 33L DR.577.330

Fig. 1 DR.582.010 Falcon

Fig. 2 DR.582.020 Falcon

SOFT LINE INSTRUMENTS
soft and sure grip



Fig. 1 DR.582.014 Falcon

Fig. 2 DR.582.024 Falcon

Hand Pluggers / Heat Carriers
Przenośnik ciepła / Upychadło endodontyczne

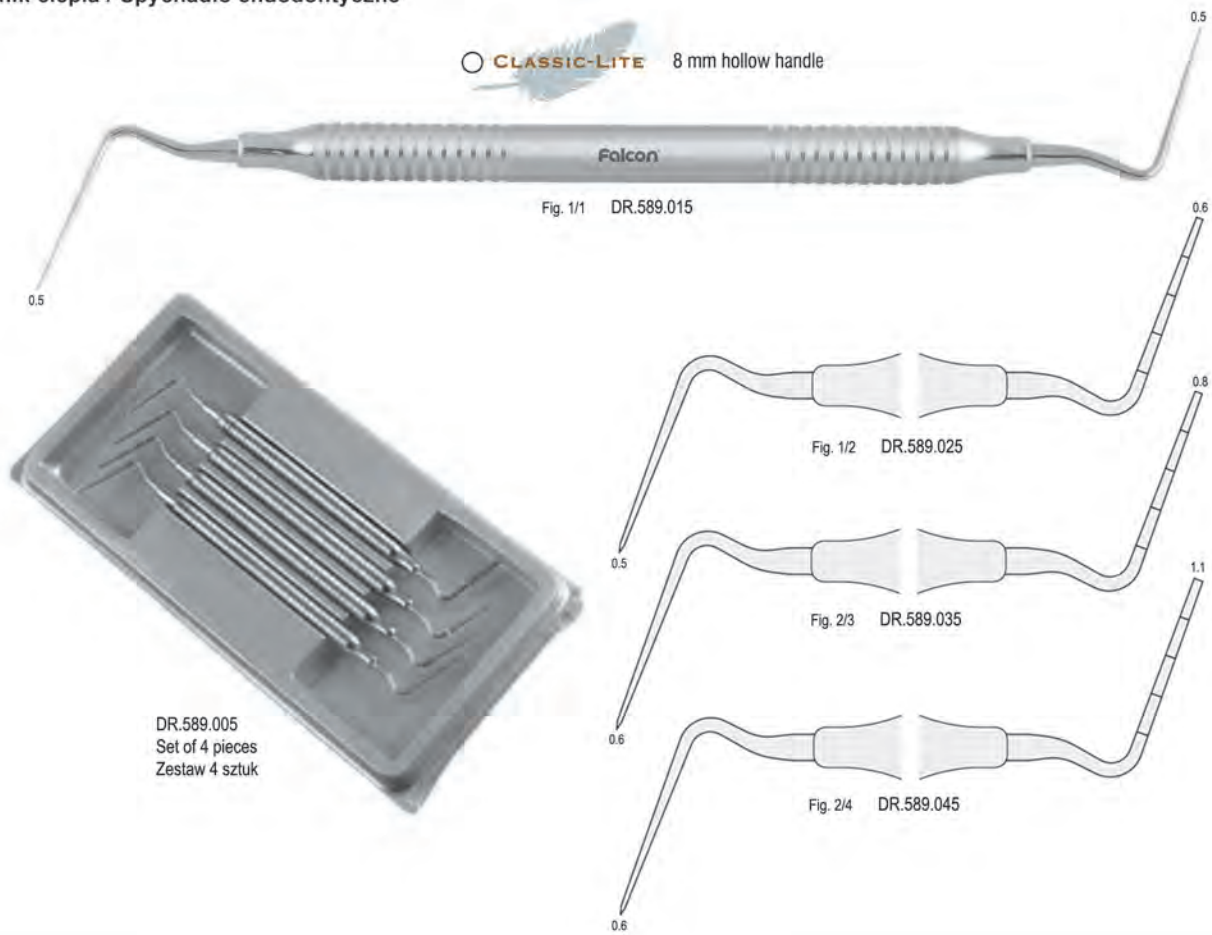

Hand Pluggers
Upychadła endodontyczne

SOFT LINE INSTRUMENTS
soft and sure grip

135° C
Autoclavable
Możliwość sterylizacji w autoklawie

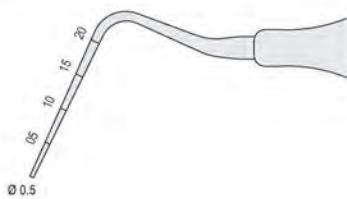

Fig. 1 DR.594.014 Falcon

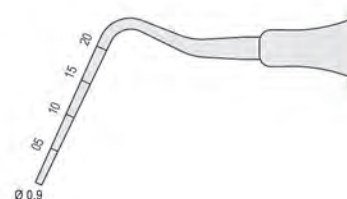

Fig. 3 DR.594.034 Falcon

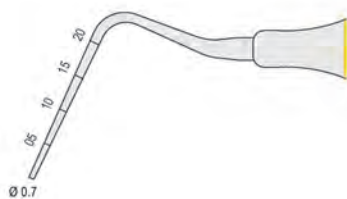

Fig. 2 DR.594.024 Falcon

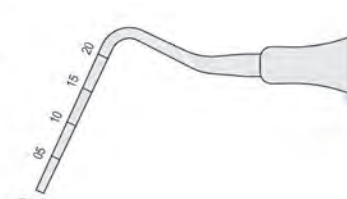

Fig. 4 DR.594.044 Falcon



Hand Spreaders
Rozpychacze endodontyczne

SOFT LINE INSTRUMENTS
soft and sure grip



Autoclavable
Możliwość sterylizacji w autoklawie



Fig. 1 DR.602.014 Falcon



Fig. 3 DR.602.034 Falcon



Fig. 2 DR.602.024 Falcon



Fig. 4 DR.602.044 Falcon

Hand pluggers
Upychadła endodontyczne

Classic Found 6 mm solid handle
6 mm pełny uchwyt



Autoclavable
Możliwość sterylizacji w autoklawie

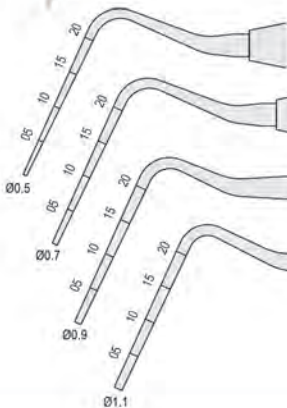

Fig. 1 DR.594.013 Falcon

Fig. 2 DR.594.023 Falcon

Fig. 3 DR.594.033 Falcon

Fig. 4 DR.594.043 Falcon

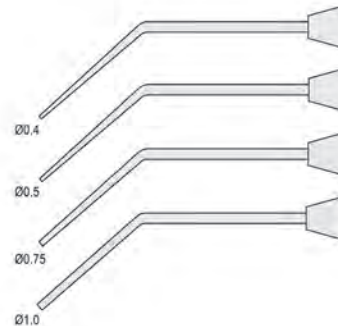

Fig. 1 DR.596.011 Luks

Fig. 2 DR.596.021 Luks

Fig. 3 DR.596.031 Luks

Fig. 4 DR.596.041 Luks

Hand spreaders
Rozpychacze endodontyczne

Classic Found 6 mm solid handle
6 mm pełny uchwyt



Autoclavable
Możliwość sterylizacji w autoklawie

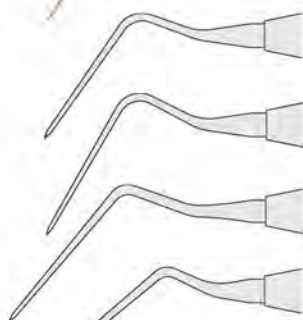

Fig. 1 DR.602.013 Falcon

Fig. 2 DR.602.023 Falcon

Fig. 3 DR.602.033 Falcon

Fig. 4 DR.602.043 Falcon

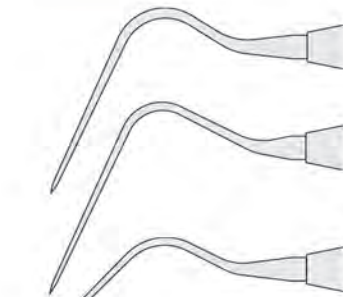

Fig. 5 DR.602.053 Falcon

Fig. 6 DR.602.063 Falcon

Fig. 7 DR.602.073 Falcon

Micro endodontic pluggers / burnishers
Przenośniki/Upychadła mikro endodontyczne

SOFT LINE INSTRUMENTS
soft and sure grip

135° C
Autoclavable
Możliwość sterylizacji w autoklawie

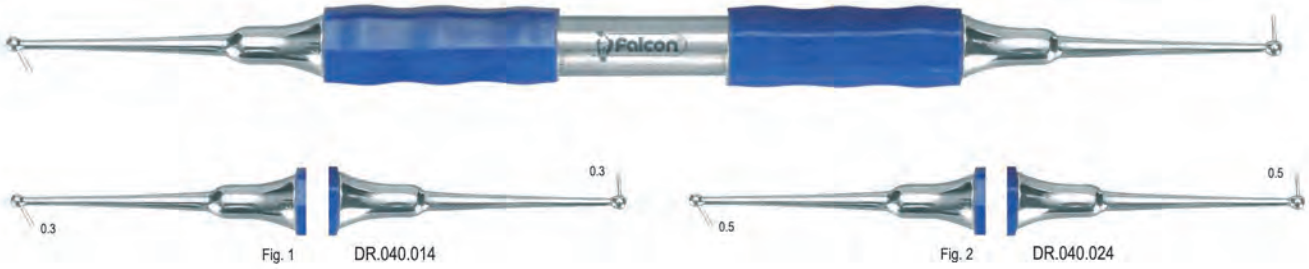

NiTi / Stainless steel hand pluggers
Przenośniki endodontyczne NiTi / Stalowe

135° C
Autoclavable
Możliwość sterylizacji w autoklawie

NiTi tip / Końcówka Niti

SS tip / Końcówka stalowa

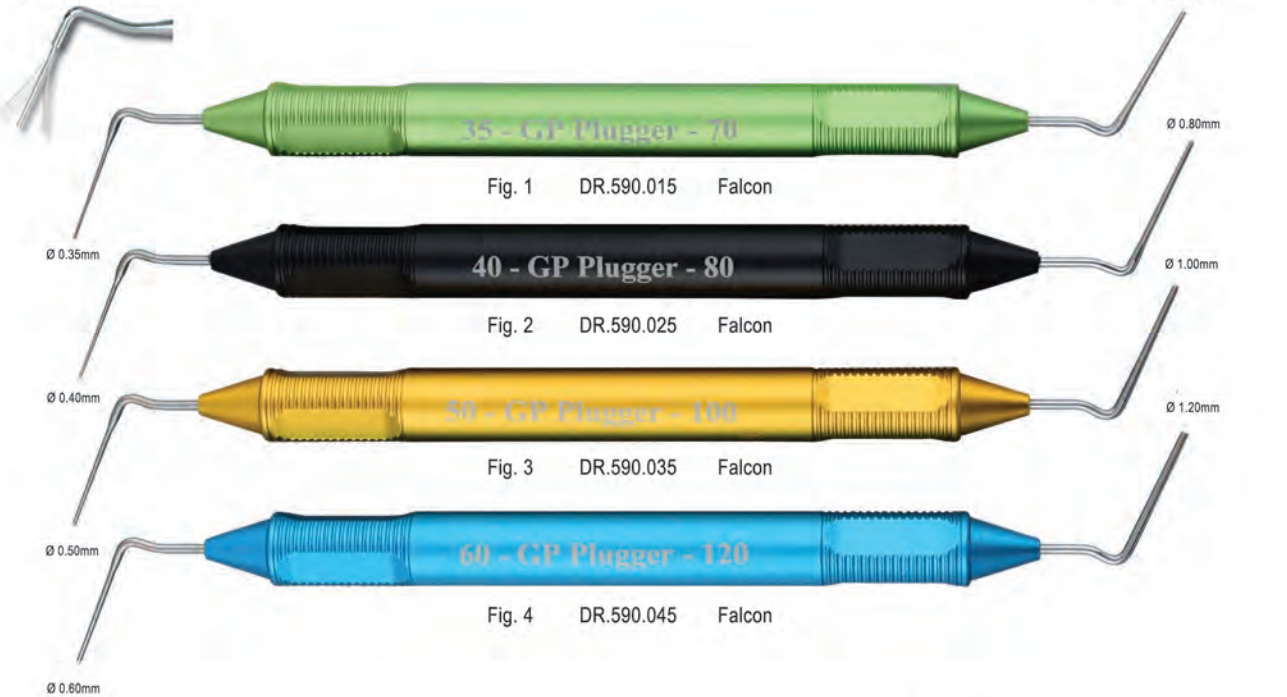

Endodontic Pluggers set
DR.590.000



Endodontic retractors
Haki endodontyczne

135° C
Autoclavable
Możliwość sterylizacji w autoklawie

SOFT LINE INSTRUMENTS
soft and sure grip



Fig. 1 DS.488.014



Fig. 2 DS.488.024



Fig. 3 DS.488.034

Micro endodontic pluggers / burnishers
Przeñośniki/Upychadła mikro endodontyczne

135° C
Autoclavable
Możliwość sterylizacji w autoklawie

SOFT LINE INSTRUMENTS
soft and sure grip

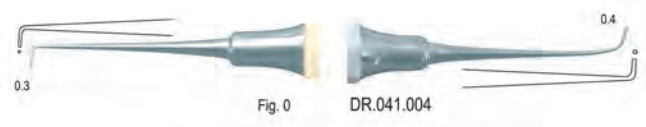

Fig. 0 DR.041.004



Fig. 1 DR.041.014

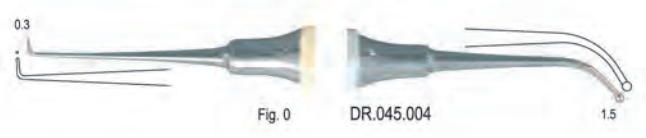

Fig. 0 DR.045.004

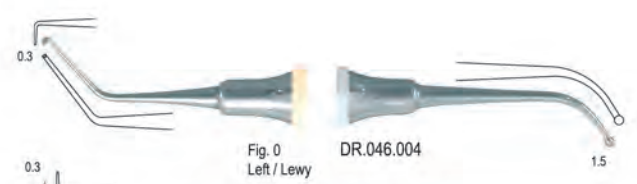

Fig. 0 Left / Lewy DR.046.004

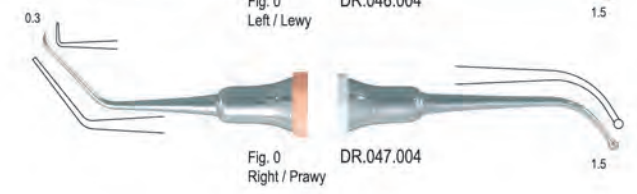
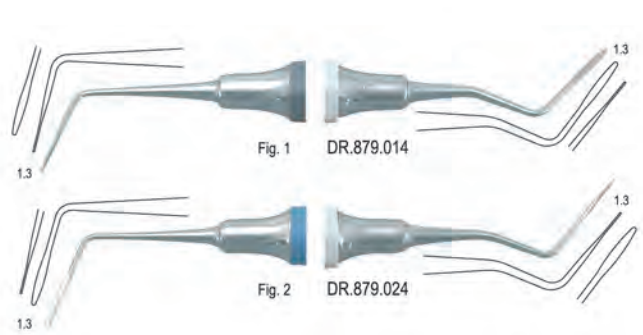
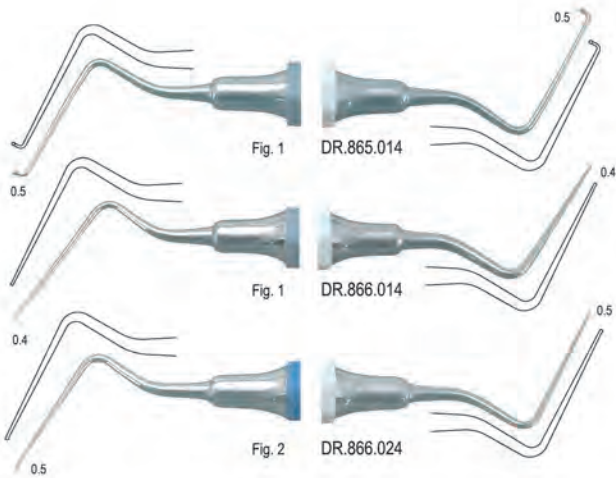

Fig. 0 Right / Prawy DR.047.004

Micro endodontic applicators
Aplikatory mikro endodontyczne

SOFT LINE INSTRUMENTS
soft and sure grip

135° C
Autoclavable
Możliwość sterylizacji w autoklawie



Endodontic curettes
Łyżeczki endodontyczne

SOFT LINE INSTRUMENTS
soft and sure grip

135° C
Autoclavable
Możliwość sterylizacji w autoklawie

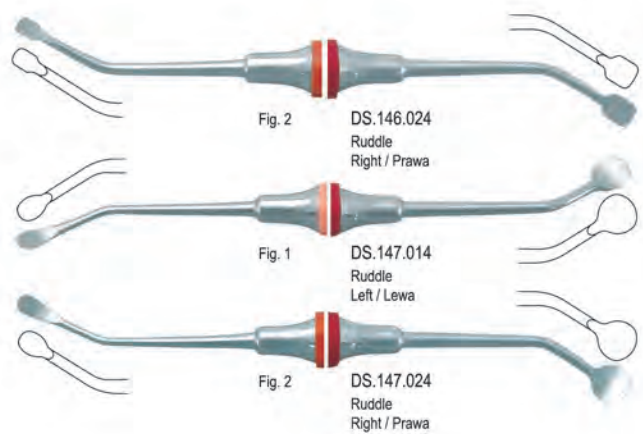
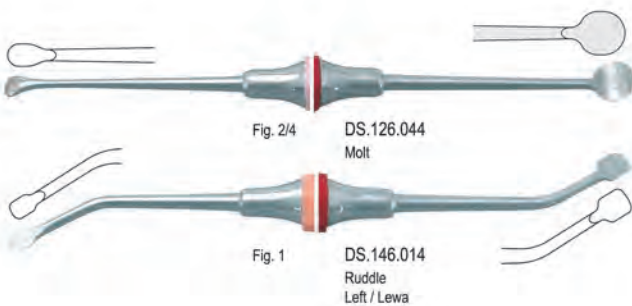

Endodontic retractors
Haki endodontyczne



BD.995.060 60°
Peet
120 mm

Endodontic tweezers
Penseta endodontyczna



DR.586.020
150 mm

Endodontic forceps for silver points
Kleszczyki endodontyczne



DR.587.130
125 mm

Endodontic forceps
Kleszczyki endodontyczne

- 
DR.587.030
Straight / Proste
- 
DR.587.040
Upward / Podgięte do góry
- 
DR.587.050
Left / Lewe
- 
DR.587.060
Right / Prawe



Endodontic instruments holder
Uchwyt do narzędzi ręcznych / pilników



DR.2999.00

Endometer
Endometr na palec



DZ.575.010



DZ.575.020
Rotatable, suitable for left or right hand
Rotacyjny na lewą lub prawą rękę



DZ.575.000

DZ.573.021
Disposable foams blue (pack of 50 pieces)
Gąbeczki jednorazowe (50 szt.)



DZ.573.001

Transparent endo files stand
Stojak przezroczysty na pilniki



Autoclavable
Możliwość sterylizacji w autoklawie



DZ.564.000
For 10 files / Na 10 pilników

Transparent endo box Mini
Endobox przezroczysty Mini



DZ.564.010
Mini
For 30 files / Na 30 pilników

Transparent endo box Midi
Endobox przezroczysty Midi



DZ.564.020
Midi
For 60 files / Na 60 pilników

Endo cleaner
Pojemnik do dezynfekcji instrumentów endodontycznych



DZ.572.010



DZ.572.040



DZ.572.020
Pink / Różowe



DZ.572.030
Blue / Niebieski

Spare sponges / Gąbeczki



2" dia. x 3/8
(50mm dia. x 8mm)

DZ.572.050
Pack of 48 pieces / Opak. 48 szt.
Ø 50 mm x 8 mm



2½" dia. x 3/8
(65mm dia. x 8mm)

DZ.572.080
Pack of 48 pieces / Opak. 48 szt.
Ø 65 mm x 8 mm

Endometer Ultima / Endometr Ultima



DZ.573.020
Disposable foams (pack of 10 pieces)
Gąbeczki jednorazowe (10 szt.)

DZ.573.001
Contents:
1 x Endo-Ruler (laser etched)
10 x Disposable medicament cups
3 x Disposable foams
Zawiera:
1 x Endo-Linijkę (laserowo nacinane wymiary)
10 x Kubków jednorazowych na leki
3 x Gąbeczki jednorazowe

Spares / Zapasy
DZ.573.010
Disposable medicament cups (pack of 50 pieces)
Kubki jednorazowe na leki (50 szt.)

D₈

Restorative / Stomatologia zachowawcza





Compo-Art

Instruments for aesthetic restorations



DR.400.011F

Super flexible spatula for application and modeling of composite material
Aplikator/Szpatułka elastyczna do kompozytu



DR.400.021F

Super flexible twisted spatula for application and modeling of composite in hard to reach areas
Aplikator/Szpatułka elastyczna do kompozytu



DR.400.031F

Super flexible twisted spatula for application and modeling of composite in hard to reach areas
Upychacz okrągły do kompozytu



DR.400.041F

Super flexible twisted spatula for application and modeling of composite in hard to reach areas
Aplikator/Szpatułka elastyczna do kompozytu



DR.400.051F

Super flexible twisted spatula for application and modeling of composite in hard to reach areas
Modelarzyk do kompozytu



DR.400.061F

Super flexible twisted spatula for application and modeling of composite in hard to reach areas
Instrument do usuwania nadmiaru wypełnienia



DR.400.071F

Super flexible twisted spatula for application and modeling of composite in hard to reach areas
Instrument do mierzenia grubości kompozytu (przednia odbudowa)



DR.400.081F

Super flexible twisted spatula for application and modeling of composite in hard to reach areas
Instrument do mierzenia grubości kompozytu (tylna odbudowa)

Compo-Art

Instruments for aesthetic restorations



DR.400.011
Super flexible spatula for application and modeling of composite material
Elastyczna szpatułka



DR.400.021
Super flexible twisted spatula for application and modeling of composite in hard to reach areas
Elastyczna szpatułka



DR.400.031
Round tipped condenser for modeling of composite
Okrągły upychacz



DR.400.041
Super flexible spatula for application and modeling of composite material
Do modelowania kompozytu



DR.400.051
Sharp pointed instrument to place fissures, grooves and pits creating the ideal occlusal anatomy
Do modelowania kompozytu

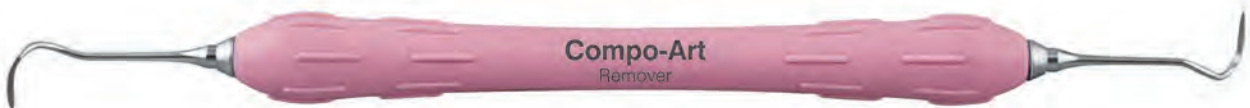

DR.400.061
Sharp instrument for the removal of excess composite and bonding material
Do usuwania nadmiaru wypełnienia



DR.400.071
Instrument to determine the vertical and horizontal thickness of composite layers on the anterior restorations
Do mierzenie grubości kompozytu



DR.400.081
Instrument to determine the vertical and horizontal thickness of composite layers on the posterior restorations
Do mierzenie grubości kompozytu

DR.400.100
Compo-Art Instruments for aesthetic restorations set of 8 + Cassette tray MIDI
Zestaw Compo-Art do estetycznej odbudowy (8 szt.) + Kasetka MIDI





Flower-Line Filling instruments / Nakładacze Flower-Line



Autoclavable
Możliwość sterylizacji w autoklawie

Non-stick tips TIN coated / Końcówki "Non-Stick" Pokryte azotkiem tytanu



Fig 1 DR.425.011F



Fig 1 DR.451.011F
Falcon



Fig 2 DR.451.021F
Falcon



Fig 1 DR.457.011F
Goldstein



Fig 2 DR.457.021F
Goldstein



Fig 3 DR.457.031F
Goldstein



Fig 4 DR.457.041F
Goldstein



Fig 1 DR.458.011F
Mini-Goldstein



Fig 3 DR.458.031F
Mini-Goldstein



Fig 1 DR.463.011F
Heidemann

Compo-fill Instruments

Easy
COLOR



Ultra Light weight
Non-stick tips
TIN coated

Bardzo lekkie
Końcówki "Non-Stick"
Pokryte azotkiem tytanu



135° C
Autoclavable
Możliwość sterylizacji w autoklawie



Silicone handle with Aluminum core
Uchwyt silikonowy z rdzeniem aluminiowym



Pluggers / Przenośniki



Fig 5A DR.051.051



Fig 3 DR.073.031
Hollenback



Fig 1 DR.091.011
Super



Fig OT DR.092.001
Tanner



Fig 0/1 DR.063.011
Black



Fig 1/2 DR.063.021
Black



Burnishers / Upychadła



Autoclavable
Możliwość sterylizacji w autoklawie

Easy
COLOR



Fig 21B DR.111.211
Acorn Wescott



Fig 1 DR.121.011
Contact Former



Fig 2 DR.121.021
Contact Former



Fig 2 DR.139.021
Ladmore



Fig 3 DR.139.031
Ladmore



Fig 27/29 DR.148.041
White



Fig 1 DR.100.011



Fig 1L DR.101.011



Fig 155 DR.135.551

Filling instruments / Nakładacze



Autoclavable
Możliwość sterylizacji w autoklawie

Easy
COLOR



Fig 156(A6) DR.426.561



Fig 8A DR.431.081



Fig 1 DR.445.011
Boghosian



Fig 2 DR.445.021
Boghosian



Fig 1 DR.451.011
Falcon



Fig 2 DR.451.021
Falcon



Fig 1 DR.457.011
Goldstein



Fig 2 DR.457.021
Goldstein



Fig 3 DR.457.031
Goldstein



Fig 4 DR.457.041
Goldstein



Fig 1 DR.458.011
Mini-Goldstein



Fig 3 DR.458.031
Mini-Goldstein



Filling instruments / Nakładacze



Autoclavable
Możliwość sterylizacji w autoklawie

Easy
COLOR



Fig 4 DR.458.041
Mini-Goldstein



Fig 4 DR.459.011
Goldstein-Micro



Fig 4/5 DR.460.051
Gregg



Fig 0 DR.463.001
Heidemann



Fig 1 DR.463.011
Heidemann



Fig 2 DR.463.021
Heidemann



Fig W3 DR.513.031



Fig 1 DR.425.011



Fig 6 DR.425.061



Fig 178 DR.426.781



Fig 49 DR.440.491



Fig 179 DR.440.791



Compo-fill Instruments TIN coated
Compo-fill Instrumenty pokryte azotkiem tytanu

135° C
Autoclavable
Możliwość sterylizacji w autoklawie

CLASSIC-LITE
10 mm hollow handle
10 mm pusty uchwyt



Pluggers / Przenośniki



Fig. 1/2 DR.063.025T Black



Fig. 3 DR.073.035T Hollenback



Fig. 1 DR.091.015T Super



Fig. 0T DR.092.005T Tanner

Burnishers / Upychadła



Fig. 21B DR.111.215T Acorn/ Wescott



Fig. 1 DR.121.015T Contact former



Fig. 3 DR.139.035T Ladmore



Fig. 27/29 DR.148.045T White

Filling Instruments / Nakładacze



Fig. 1 DR.425.015T



Fig. 6 DR.425.065T



Fig. 156 (A6) DR.426.565T



Fig. 178 DR.426.785T



Fig. 49 DR.440.495T



Fig. 2 DR.451.025T Falcon



Fig. 1 DR.457.015T Goldstein



Fig. 2 DR.457.025T Goldstein



Fig. 4 DR.458.045T Goldstein-mini



Fig. 4/5 DR.460.055T Gregg



Fig. 2 DR.463.025T Heidemann



Fig. W3 DR.513.035T



Burnishers / Upychadła

TIN coated / Pokryte azotkiem tytanu

Classic-Round

6 mm solid handle
6 mm pełny uchwyt

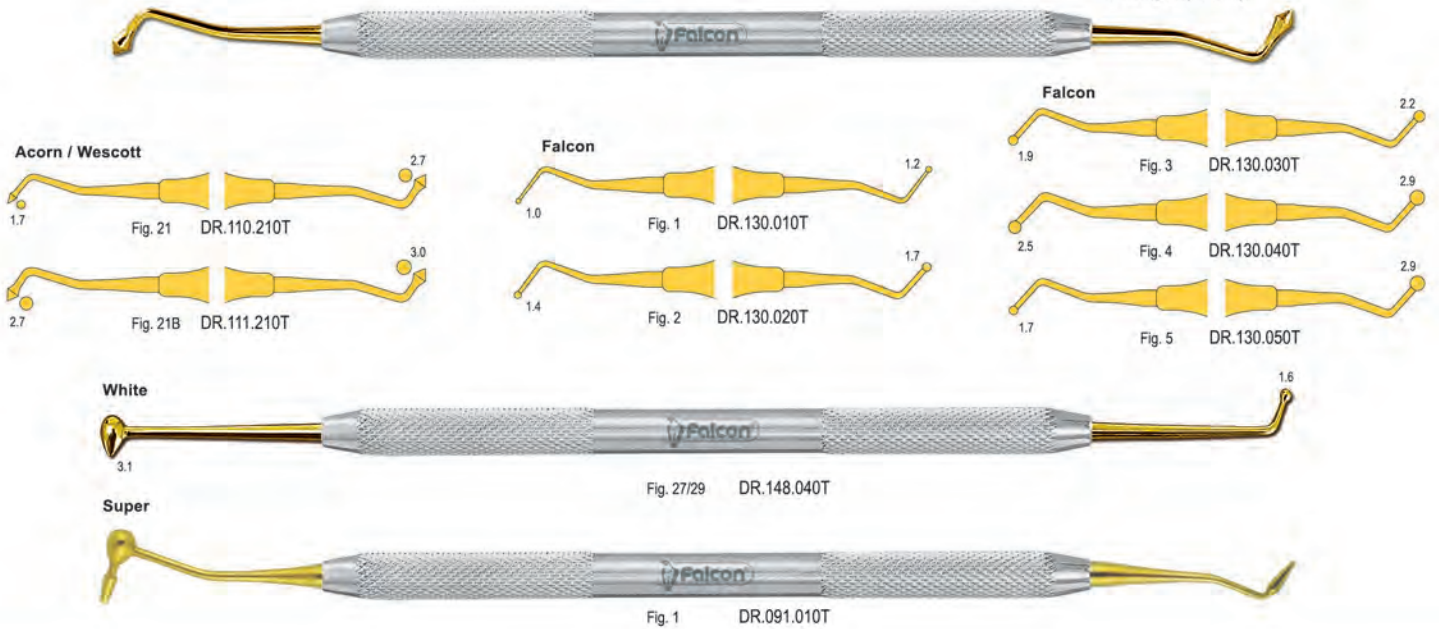

Filling instruments / Nakładacze

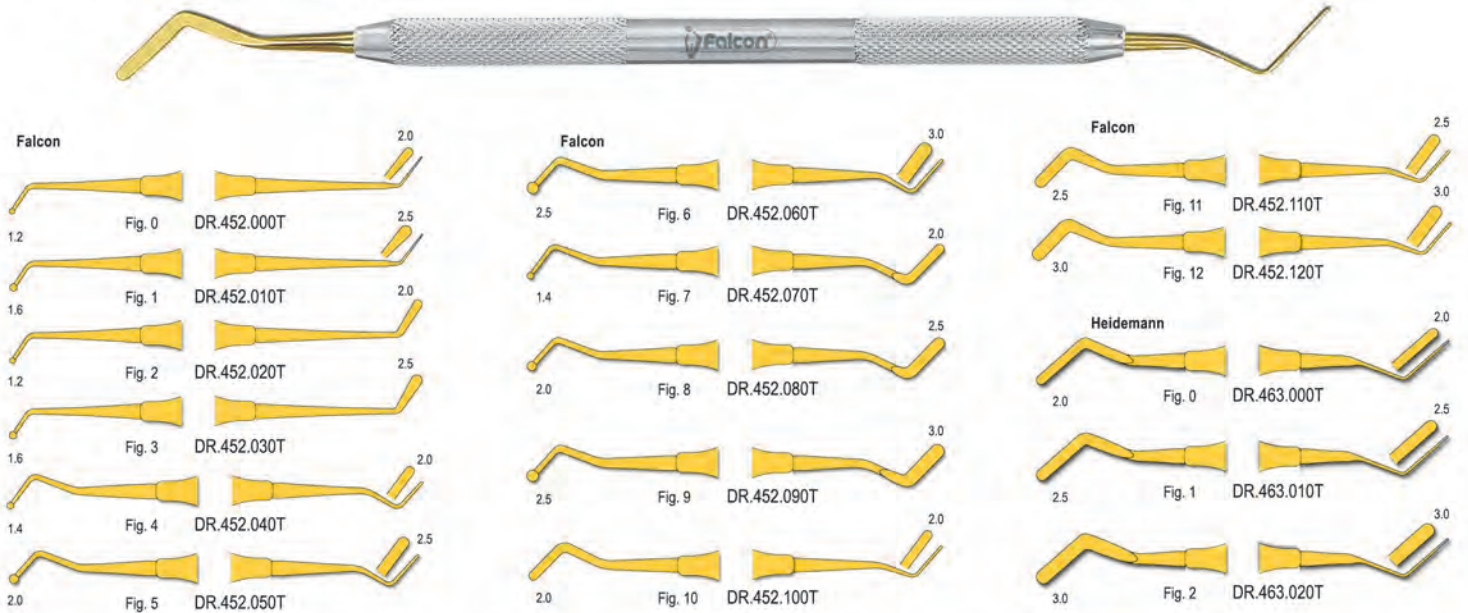

Plastic amalgam carriers / Pistolet do amalgamatu plastikowe

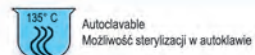

PP011/0041
Right angled
Zagięty pod kątem



PP011/0042
Curved
Zagięty

Amalgam carriers / Pistolety do amalgamatu

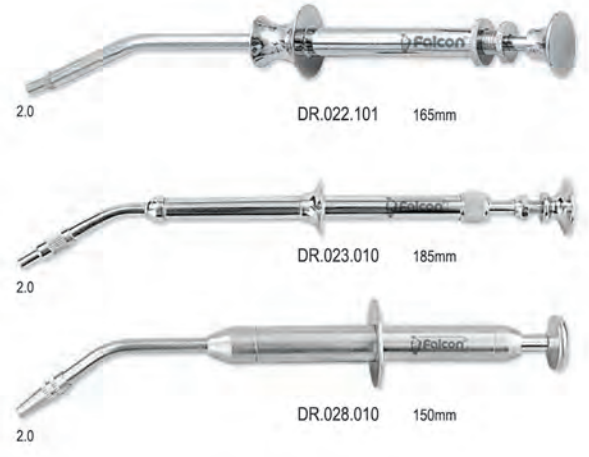
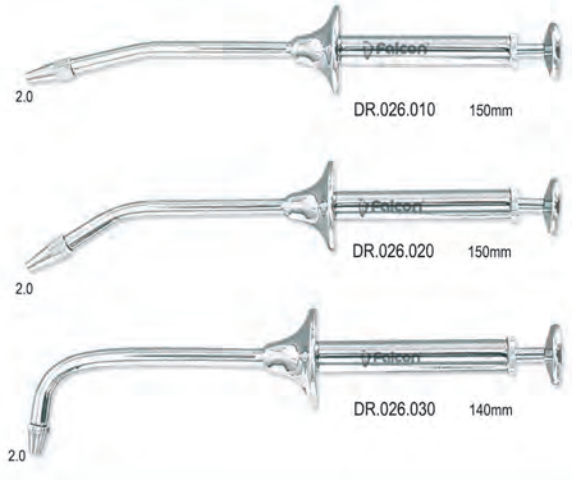

Amalgam guns / Pistolety do amalgamatu

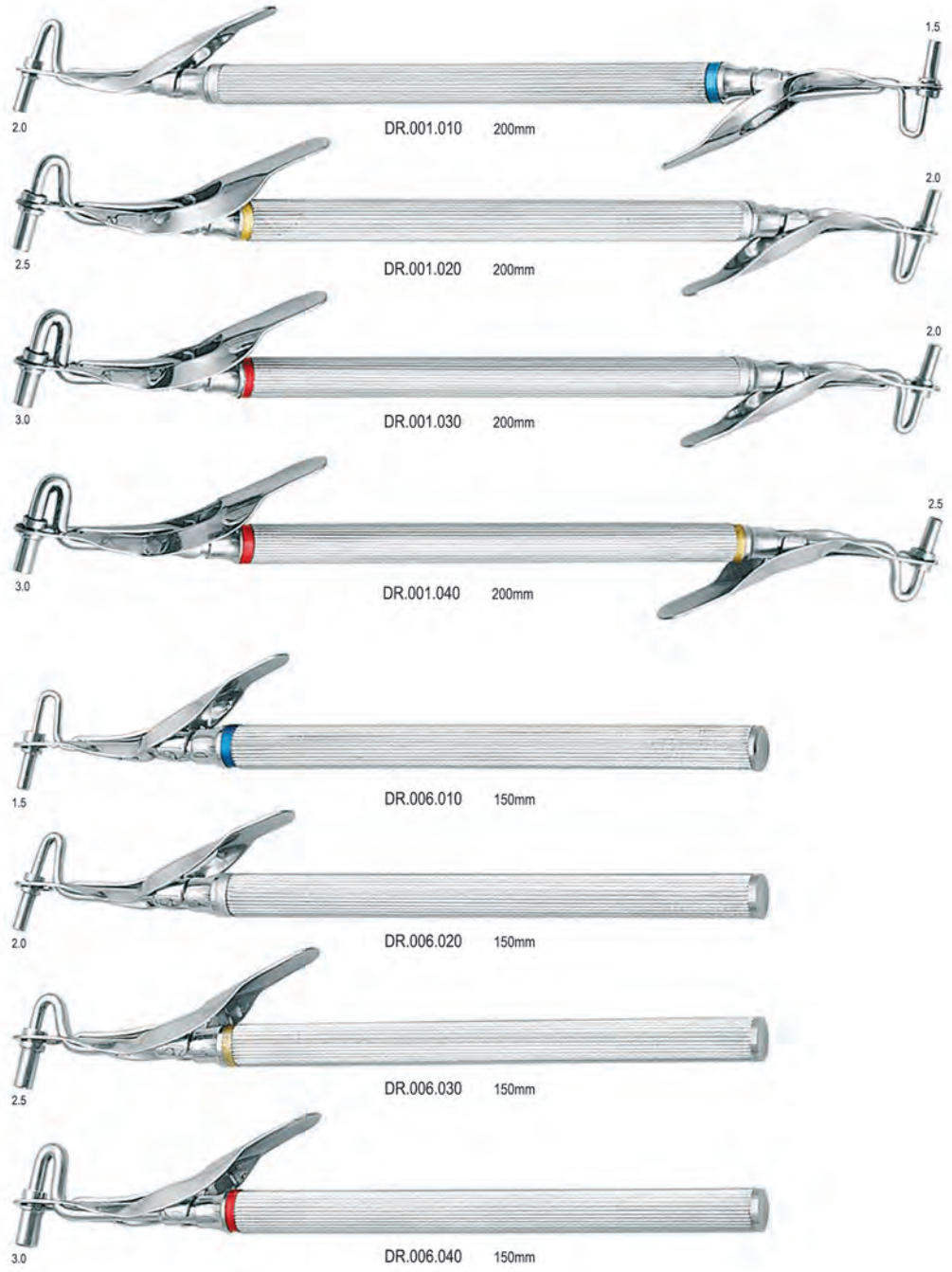



Pluggers / Przenośniki

Classic Round
6 mm solid handle
6 mm pełny uchwyt

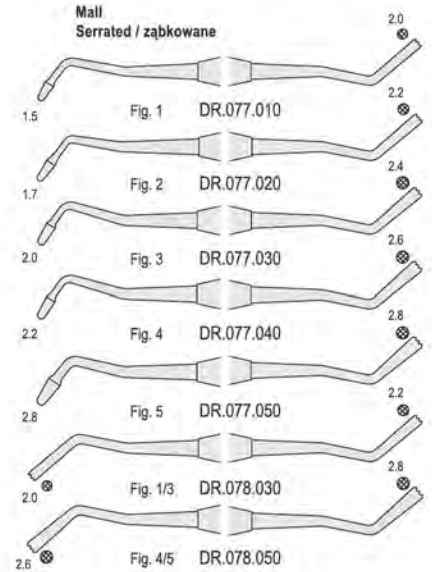
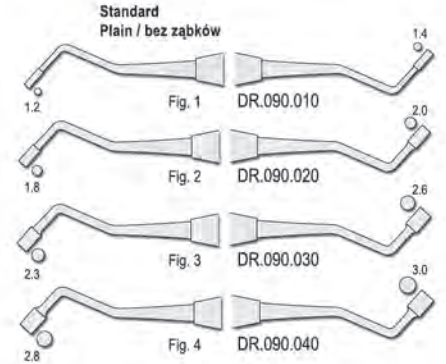
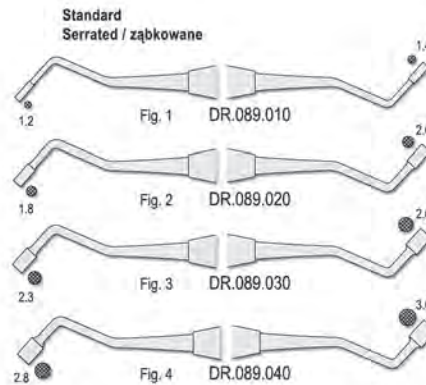
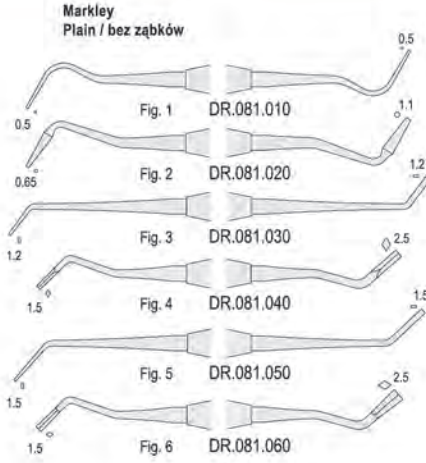
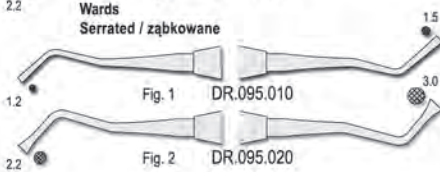
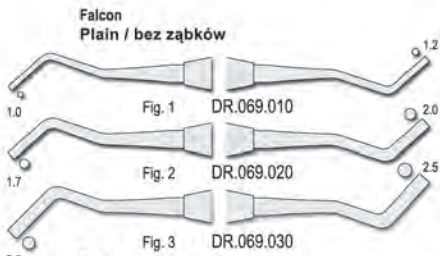
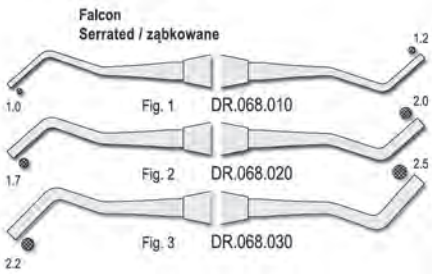
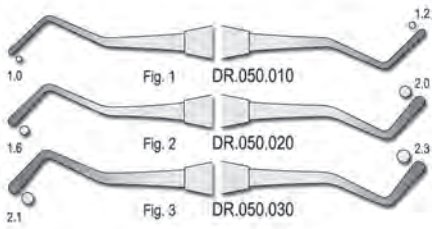

Burnishers / Upychadła

SOFT LINE INSTRUMENTS
soft and sure grip

135° C
Autoclavable
Możliwość sterylizacji w autoklawie

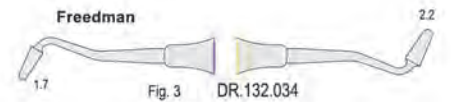
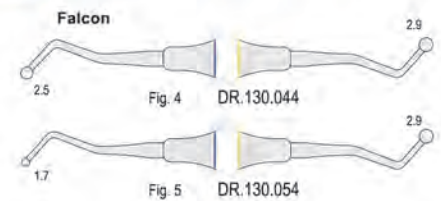
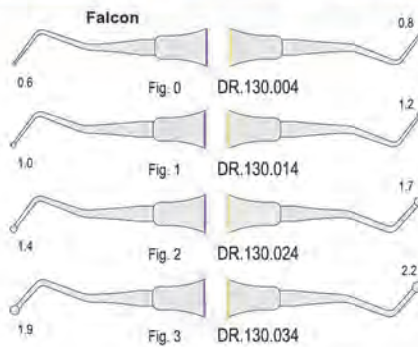
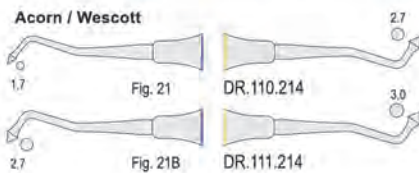



Amalgam well / Miseczka do amalgamatu



DR.098.010
Autoclavable
Możliwość sterylizacji w autoklawie

**Amalgam gun for micro filling
Pistolet do amalgamatu do mikro wypełnień**



Ø 1.2 mm
DR.024.020 Straight / Prosty
DR.024.030 Curved / Zagięty
130 mm

**Pluggers
Przenośniki**



SOFT LINE INSTRUMENTS
soft and sure grip

135° C Autoclavable
Możliwość sterylizacji w autoklawie

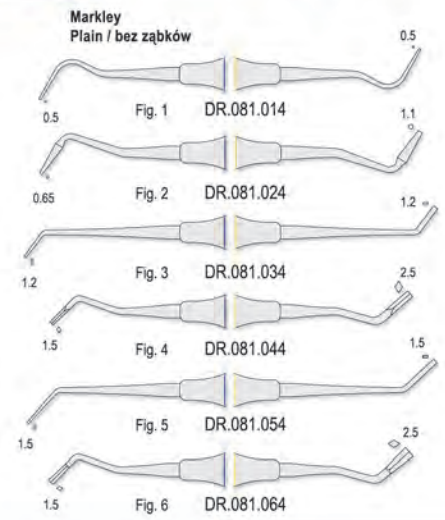
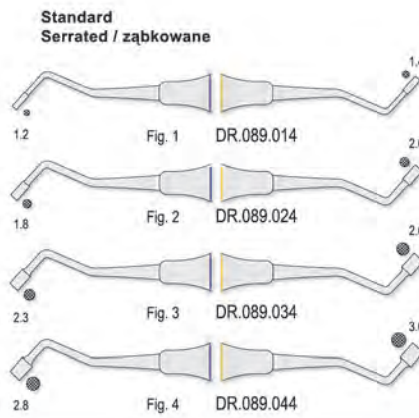
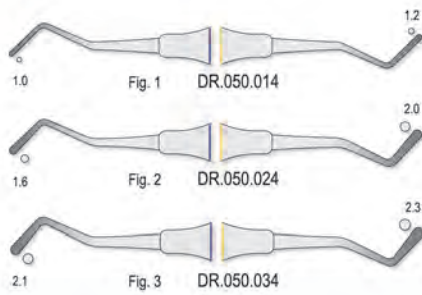

Super plugger / Przenośnik Super



Fig.1 DR.091.014

Pluggers / Przenośniki



Classic 8
5.5 mm solid handle
5.5 mm pełny uchwyt

Fig.1 DR.091.017

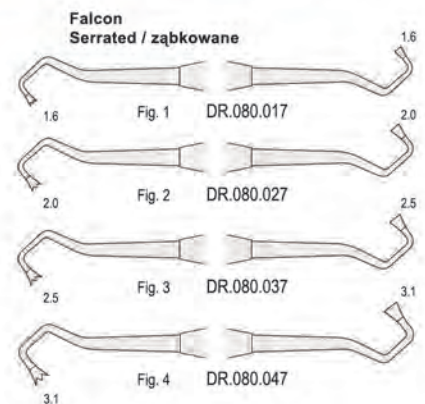
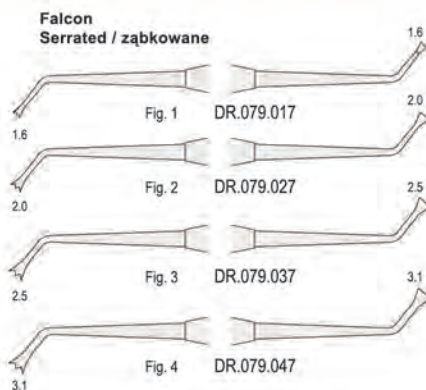
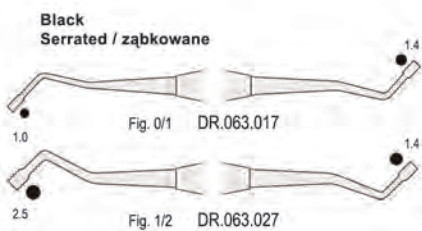



Burnishers / Upychadła

CLASSICLITE

8 mm hollow handle
8 mm pusty uchwył



Acorn / Wescott



Falcon



Falcon



White

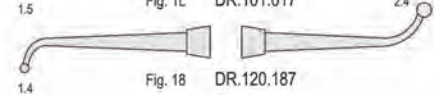
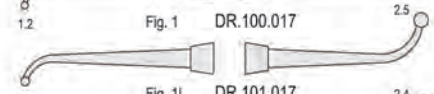
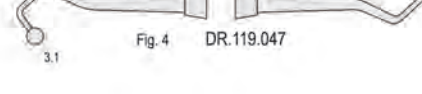
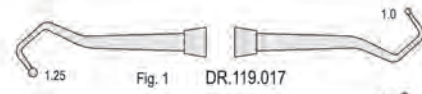
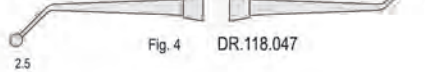
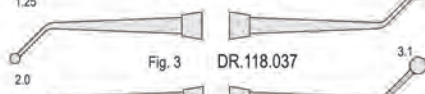
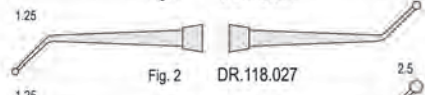

Fig. 27/29 DR.148.045

Burnishers / Upychadła

Classic-8

5.5 mm solid handle
5.5 mm pelny uchwył



Burnishers / Upychadła

Classic Round

6 mm solid handle
6 mm pelny uchwył



Acorn / Wescott

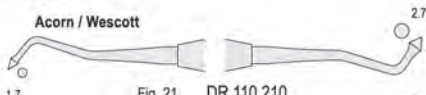

Ladmore



Falcon

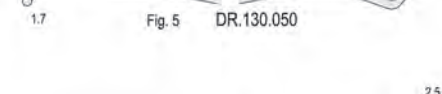
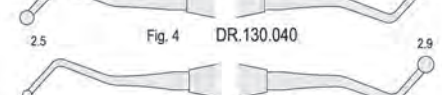
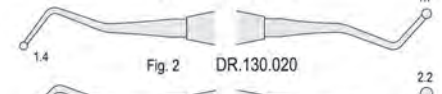
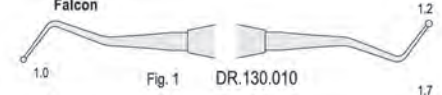

Beavertail / White

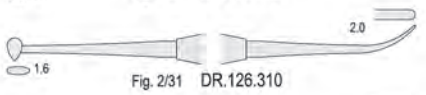

White

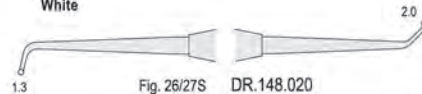



**Filling instruments
Nakładacze**



Autoclavable
Możliwość sterylizacji w autoklawie



SOFT LINE INSTRUMENTS
soft and sure grip

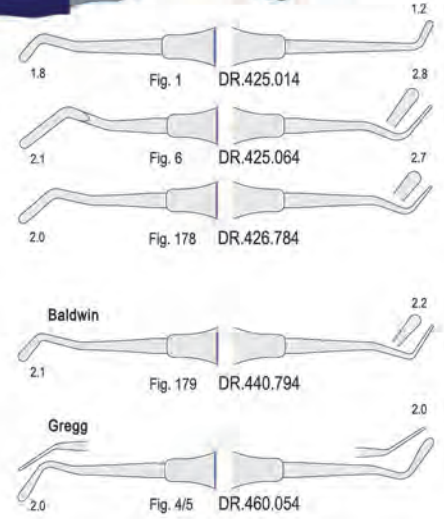
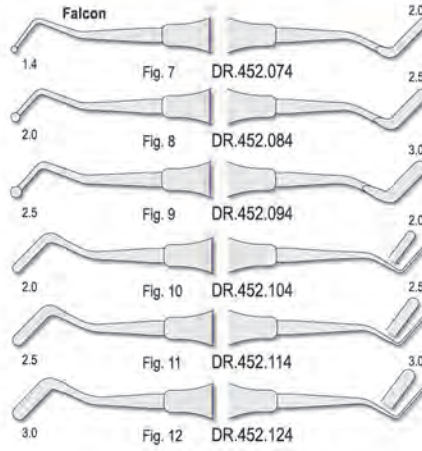
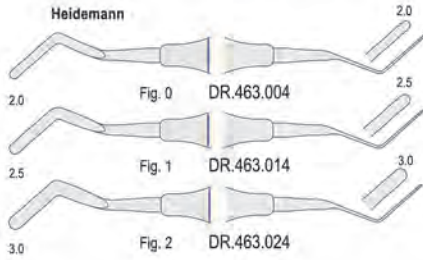

**Filling instruments
Nakładacze**

Classic-8
5.5 mm solid handle
5.5 mm pełny uchwyt

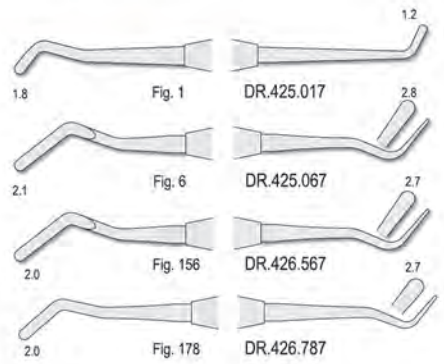
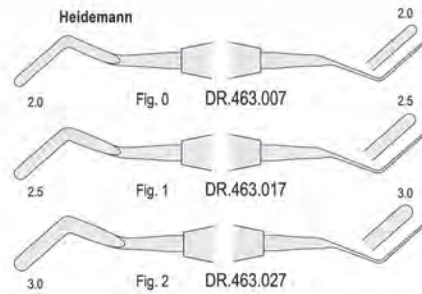
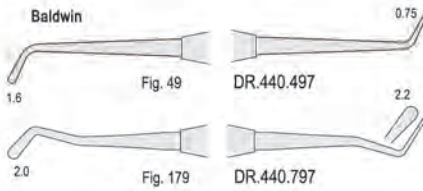

**Filling instruments
Nakładacze**

CLASSIC-LITE
10 mm hollow handle
10 mm pusty uchwyt

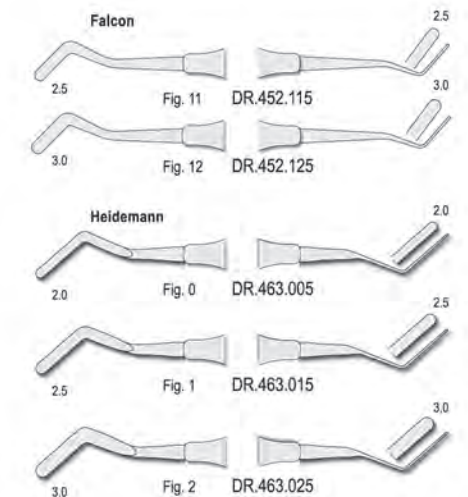
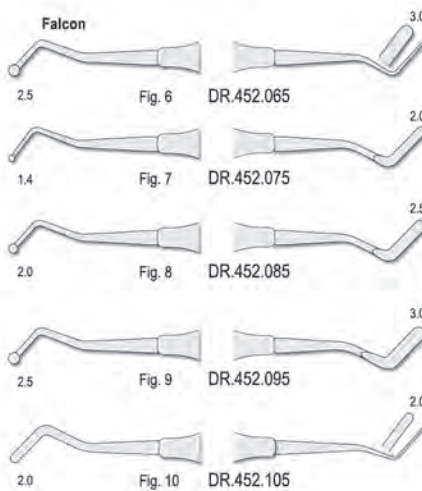
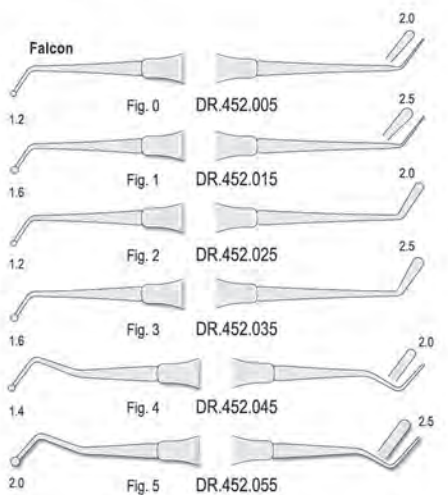

Filling instruments
Nakładacze

Classic Round
6 mm solid handle
6 mm pełny uchwyt

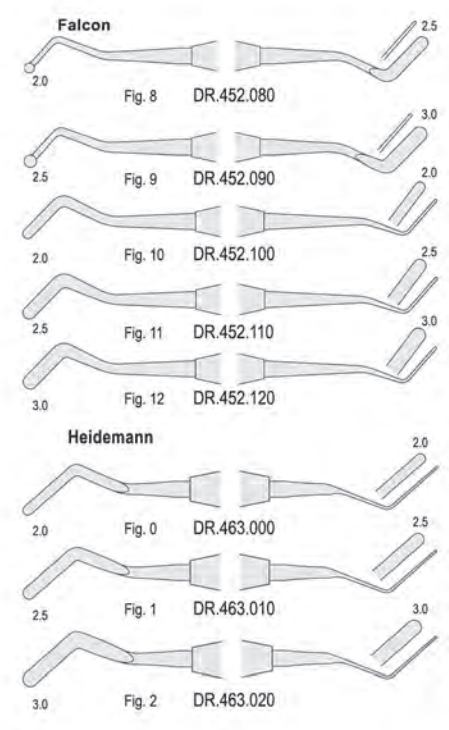
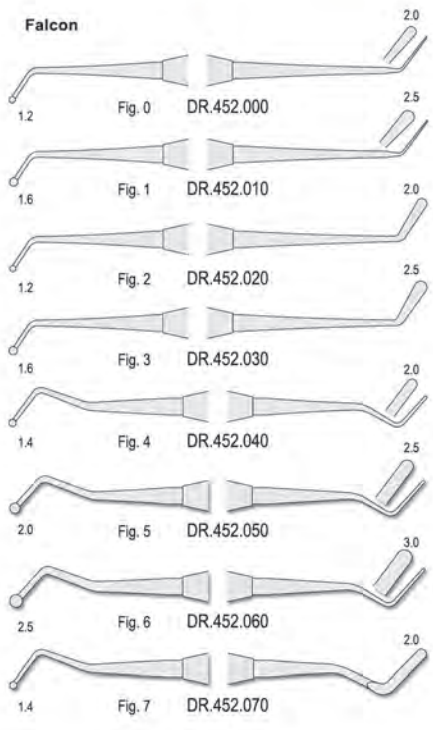
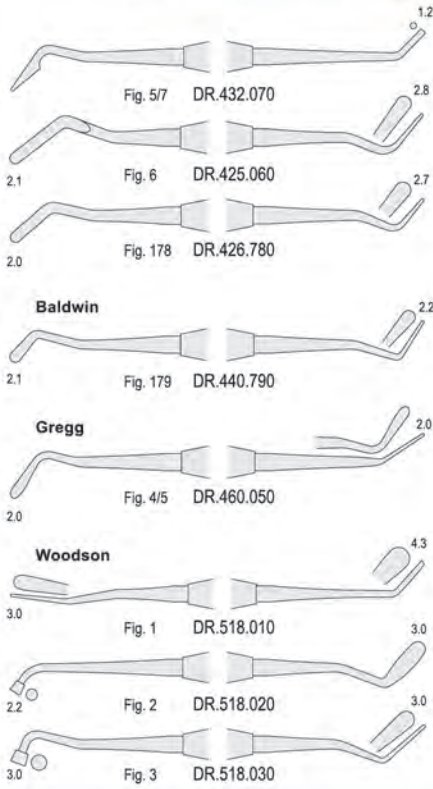

Cement spatulae
Łopatki do cementu

SOFT LINE INSTRUMENTS
soft and sure grip

 135° C Autoclavable
Możliwość sterylizacji w autoklawie



Cement spatulae
Łopatki do cementu

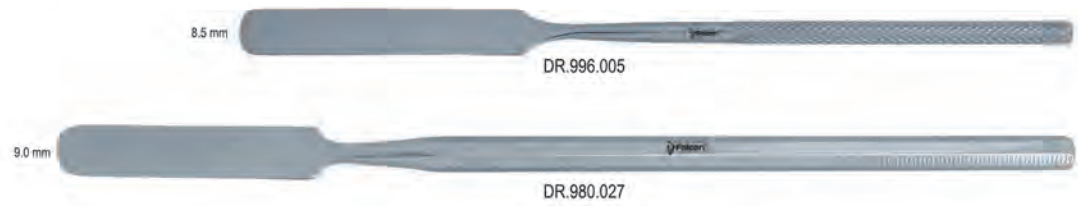



Restorative Stomatologia zachowawcza

Cement spatulae Łopatki do cementu

Classic-Round
6 mm solid handle
6 mm pełny uchwyt



Cement spatulae Łopatki do cementu

Classic-8
5.5 mm solid handle
5.5 mm pełny uchwyt



Glass slabs Płytki do cementu

A mm	B mm	C mm	Code Kod
95	70	5	DR.998.010
120	80	5	DR.998.020
150	80	12	DR.998.030



Mixing pads Bloczki papierowe do mieszania



DENTALINE®

DZ.458.010	50 x 50 mm
DZ.458.020	75 x 75 mm
DZ.458.030	75 x 125 mm
DZ.458.040	100 x 140 mm
DZ.458.050	140 x 180 mm

Excavators Wydrążacze / Ekskawatory

SOFT LINE INSTRUMENTS
soft and sure grip



135° C
Autoclavable
Możliwość sterylizacji w autoklawie

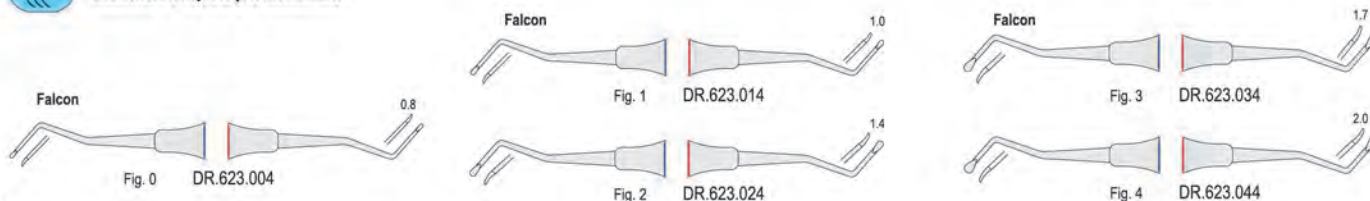

Excavators
Wydrążacze / Ekskawatory

Classic Round
6 mm solid handle
6 mm pełny uchwyt

135° C
Autoclavable
Możliwość sterylizacji w autoklawie

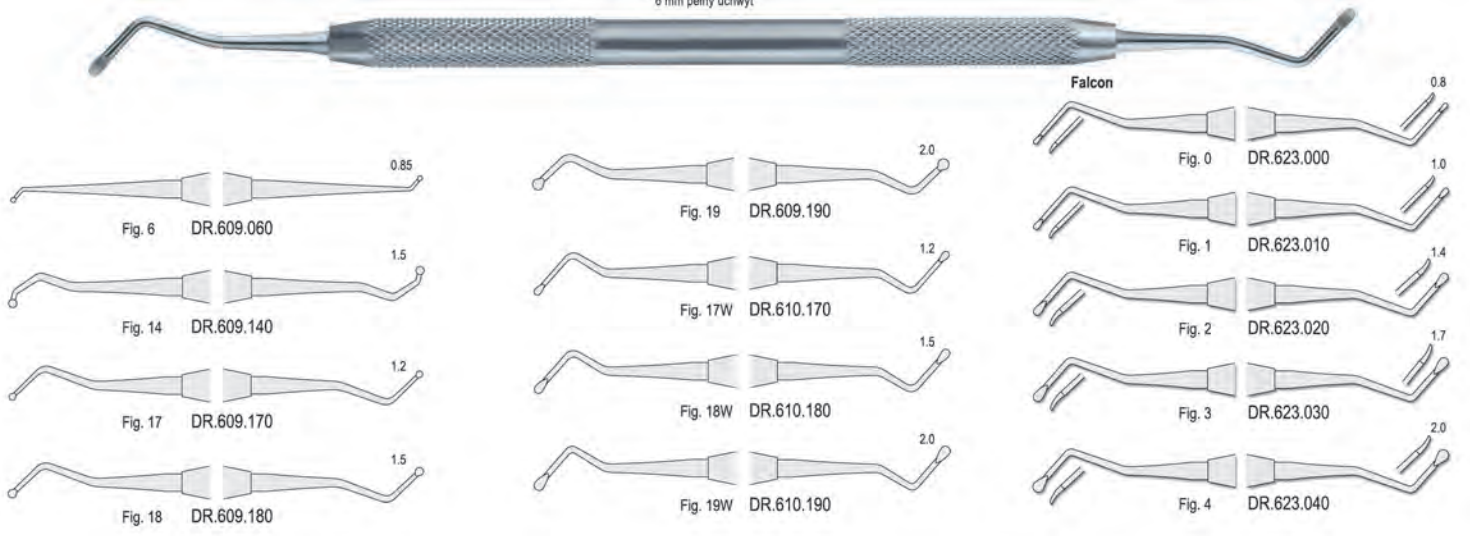

Excavators
Wydrążacze / Ekskawatory

Classic-8
5.5 mm solid handle
5.5 mm pełny uchwyt

135° C

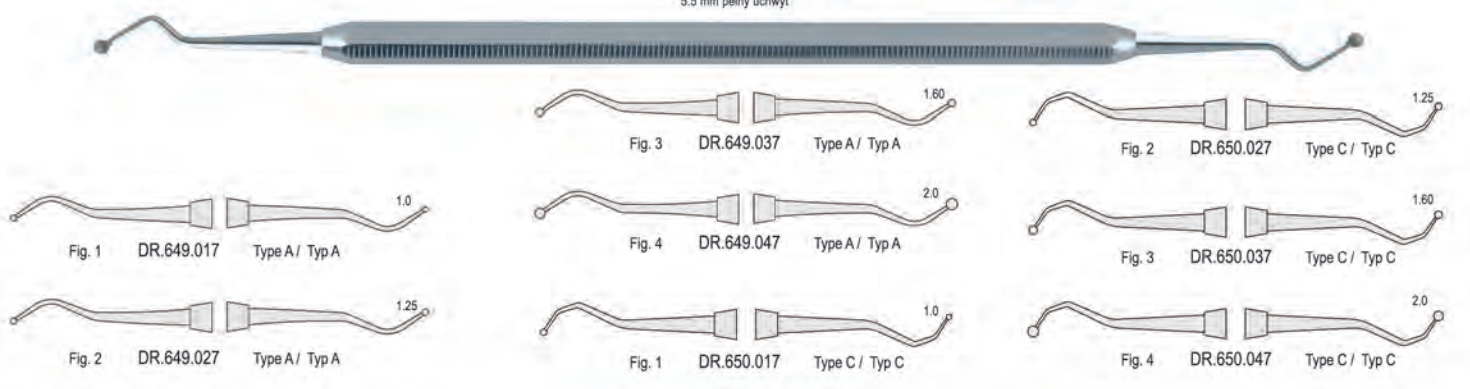

Finishing knives
Nożyki do modelowania kompozytu

SOFT LINE INSTRUMENTS
soft and sure grip

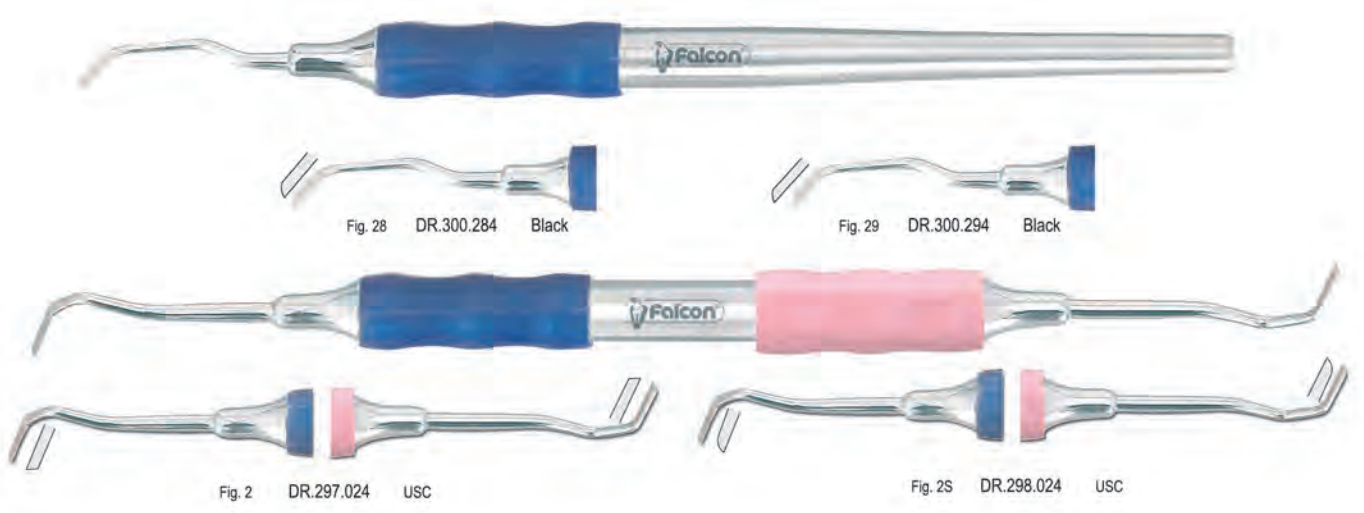



Cavity preparation instruments
Wydrążacze / Ekskawatory

Classic Round
6 mm solid handle
6 mm pełny uchwyt

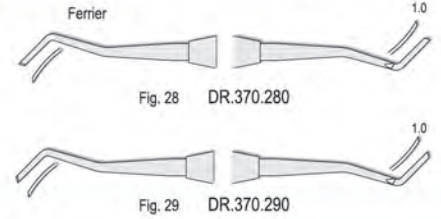
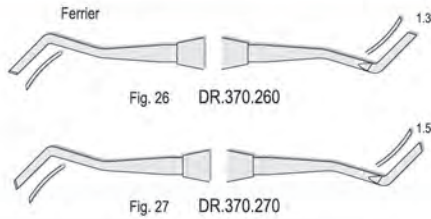
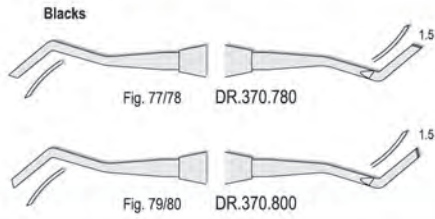

Carvers
Nożyki do modelowania

Classic Round
6 mm solid handle
6 mm pełny uchwyt

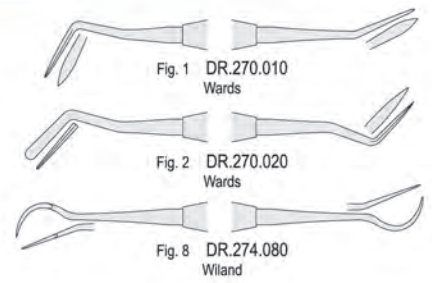
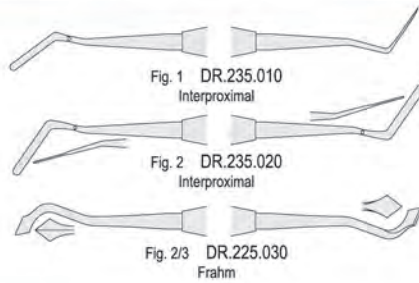
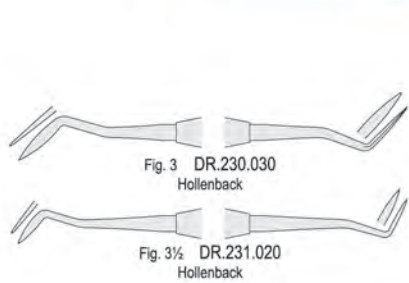

Carvers
Nożyki do modelowania

SOFT LINE INSTRUMENTS
soft and sure grip

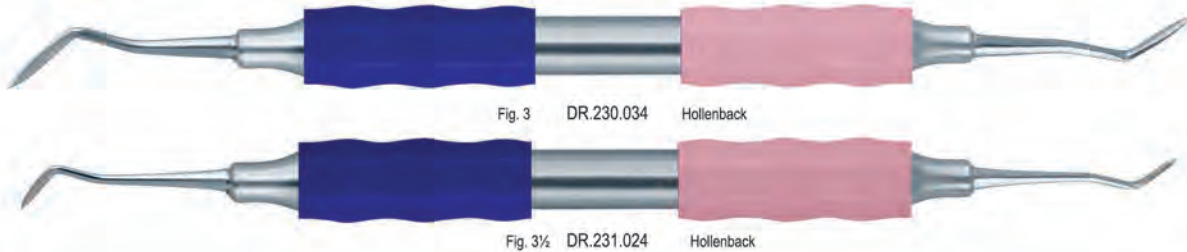

Finishing knives / Nożyki do modelowania kompozytu

CLASSIC-LITE
10 mm hollow handle
10 mm pusty uchwyt



Cleoid-Discoid
Cleoid-Discoid

Classic Round
6 mm solid handle
6 mm pełny uchwyt

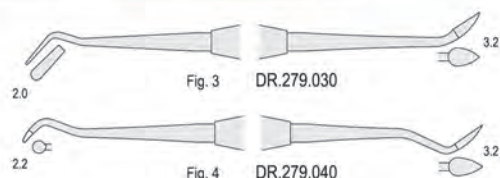
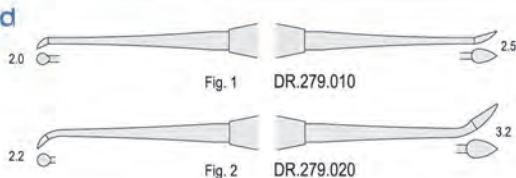



Cleoid-Discoïd
Cleoid-Discoïd

SOFT LINE INSTRUMENTS
soft and sure grip

135° C Autoclavable
Możliwość sterylizacji w autoklawie

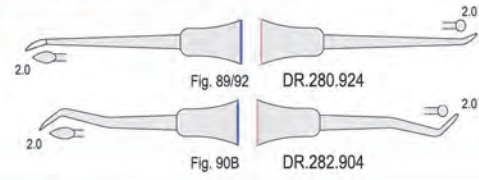
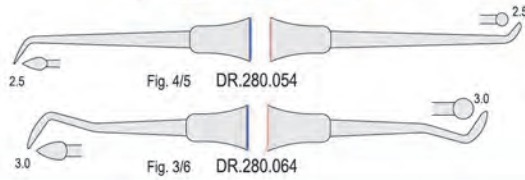

Filling removing instrument
Instrument do usuwania wypełnienia



Fig. 1 DR.527.014



Fig. 4 DR.527.045

Applicators for calcium hydroxide
Aplikatory do dycal



DR.872.001



DR.872.005



DR.867.000



DR.868.000

Applicator for medicaments
Aplikator do leków



DR.873.017
Orban

Serie-UNO
Economical dental instruments
Instrumenty stomatologiczne w atrakcyjnej cenie

135° C Autoclavable
Możliwość sterylizacji w autoklawie



Pluggers / Przenośniki

Pack of 5 pieces / Opak. 5 szt.



Fig. 1/2 DX.705.020 Black



Fig. 2 DX.708.020 Mall



Fig. 4/5 DX.708.050 Mall

Burnishers / Upychadła

Pack of 5 pieces / Opak. 5 szt.



Fig. 21B DX.713.211 Acorn/Wescott

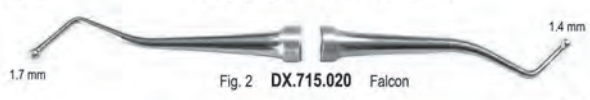

Fig. 2 DX.715.020 Falcon



Fig. 4 DX.715.040 Falcon



Serie-UNO

Economical dental instruments

Instrumenty stomatologiczne w atrakcyjnej cenie



Autoclavable
Możliwość sterylizacji w autoklawie



Filling instruments / Nakładacze

Pack of 5 pieces / Opak. 5 szt.

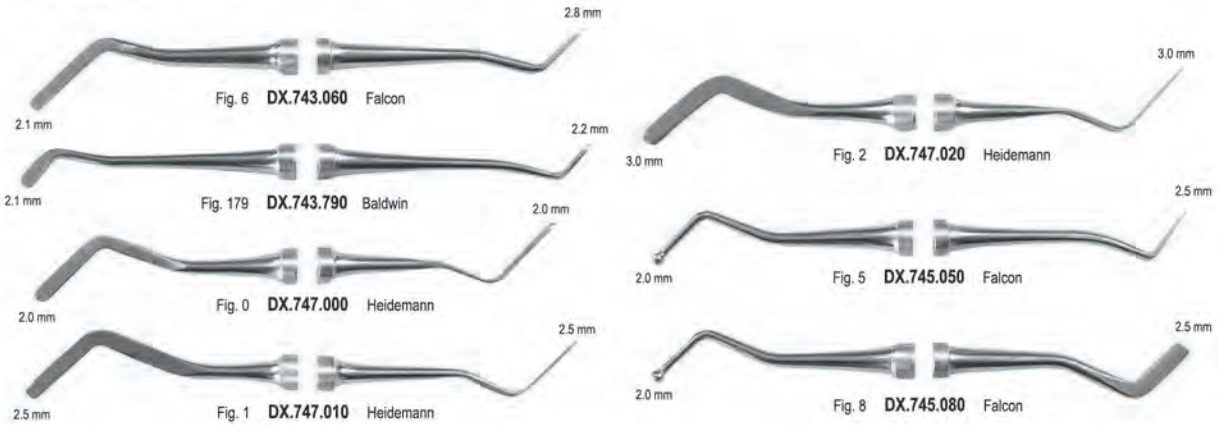

Cement spatula / Łopatka do cementu

Pack of 5 pieces / Opak. 5 szt.



**Automatic crown and bridge remover
Zbijak do koron samopowtarzalny**

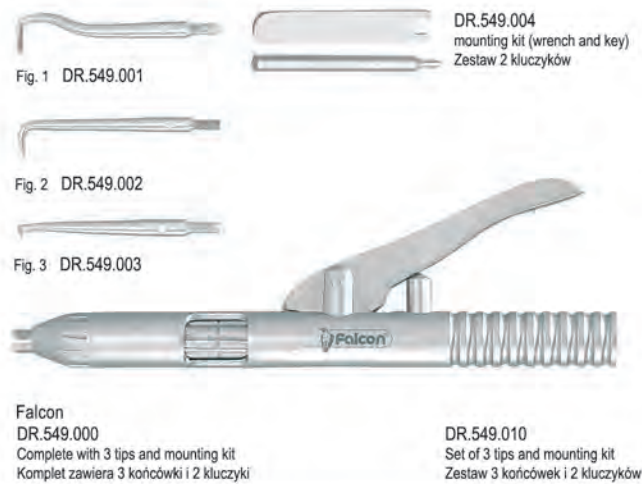

**Semi-automatic crown and bridge remover
Zbijak do koron trzystopniowy**

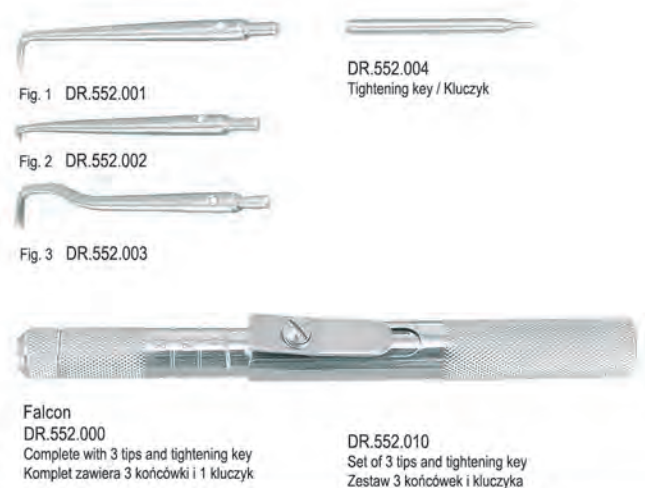

**Manual crown remover double ended
Zbijak do koron ręczny dwustronny**



**Manual crown remover
Zbijak do koron ręczny**

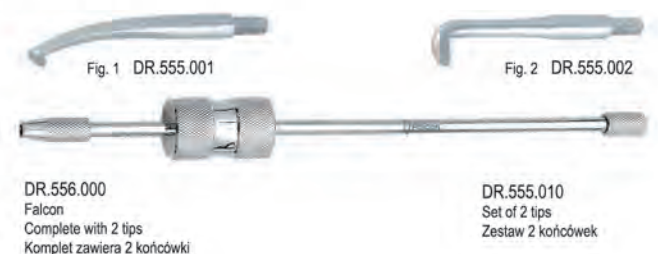



Manual crown remover
Zbijak do koron ręczny



Fig. 1 DR.559.001

Fig. 2 DR.559.002

Fig. 3 DR.559.003

Morrel
DR.559.000
Complete with 3 tips
Komplet zawiera 3 końcówki

DR.559.010
Set of 3 tips
Zestaw 3 końcówek

Manual crown remover with spring
Zbijak do koron ręczny ze sprężyną

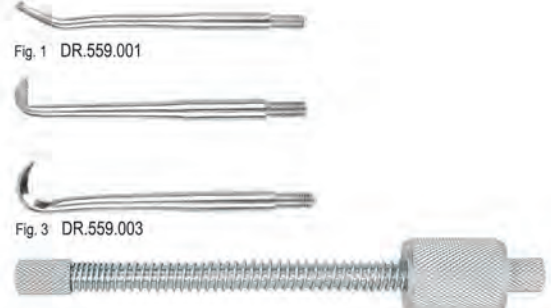

Fig. 1 DR.559.001

Fig. 3 DR.559.003

Morrel
DR.560.000
Complete with 3 tips
Komplet zawiera 3 końcówki

DR.560.010
Set of 3 tips
Zestaw 3 końcówek

Manual crown remover double ended
Zbijak do koron ręczny dwustronny

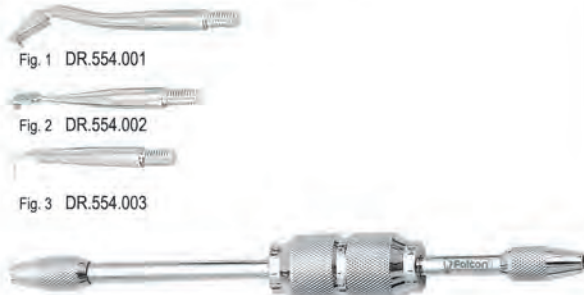

Fig. 1 DR.554.001

Fig. 2 DR.554.002

Fig. 3 DR.554.003

Falcon
DR.554.000
Complete with 3 tips
Komplet zawiera 3 końcówki

DR.554.010
Set of 3 tips
Zestaw 3 końcówek

Crown pliers
Kleszcze do koron



DR.531.165
Wynman-Falcon
160 mm
With Tungsten Carbide inserts
z wkładką z węgla spiekane

DR.532.160
Wynman-Falcon
160 mm
With Tungsten Carbide inserts
z wkładką z węgla spiekane

Temporary crown removing pliers
Kleszcze do zdejmowania tymczasowe koron



DR.535.000
155mm

DR.535.010
Set of 10 tips
Zestaw 10 końcówek



DR.539.010
Furrer
160 mm

DL.151.125
Bohm
125 mm

DL.151.150
Bohm
150 mm



Diamond Coated
Pokryte diamentem



Crown spreaders
Rozwieracze do koron



DR.570.000
Falcon



Fig. 3 DR.571.030



Fig. 0 DR.571.000



Fig. 1 DR.571.010



Fig. 2 DR.571.020

Crown spreaders
Rozwieracze do koron



DR.570.010
Falcon
145mm

Manual crown remover / Crown spreaders
Rozwieracze do koron



DR.572.000
Complete with 6 tips
Komplet zawiera 6 końcówek

Forceps for articulating paper
Pensety do kalki



DR.700.010
Miller
150 mm



DR.700.020
Miller
150 mm



DR.698.010
Falcon
150 mm



DR.699.010
Falcon
Full arch / Pełny łuk



Contoured anatomical matrices
Paseki anatomiczne do formówek

Pack of 30 pieces / Opak. 30 sztuk
Grubość 0.05 mm
Grubość 0.035 mm



DR.811.010 Thickness 0.05 mm
DR.812.010 Thickness 0.035 mm
Premolars left
Przedtrzonowca lewa



DR.811.020 Thickness 0.05 mm
DR.812.020 Thickness 0.035 mm
Premolars right
Przedtrzonowca prawa



DR.811.030 Thickness 0.05 mm
DR.812.030 Thickness 0.035 mm
Molars left
Trzonowca lewa



DR.811.040 Thickness 0.05 mm
DR.812.040 Thickness 0.035 mm
Molars right
Trzonowca prawa



DR.811.050 Thickness 0.05 mm
DR.812.050 Thickness 0.035 mm
Premolars left, right
Przedtrzonowca obustronne



DR.811.060 Thickness 0.05 mm
DR.812.060 Thickness 0.035 mm
Molars left, right
Trzonowca obustronne



DR.811.000 Thickness 0.05 mm
DR.812.000 Thickness 0.035 mm
Assorted
Asortyment

Matrix bands
Paski do formówek

Thickness / Grubość
0.04 mm



DR.799.050 5 mm
DR.799.060 6 mm
DR.799.070 7 mm
Length / Długość 10 meter

Thickness / Grubość
0.05 mm



DR.800.050 5 mm
DR.800.060 6 mm
DR.800.070 7 mm
Length / Długość 10 meter

Ivory
Pack of 12 pieces
Opak. zawiera 12 szt.
Thickness / Grubość
0.05 mm



Fig. 11 DR.806.010
for children / dziecięce



Fig. 12 DR.806.020
for children / dziecięce



Fig. 14 DR.805.010
small / male



Fig. 15 DR.805.020
medium / średnie



Fig. 16 DR.805.030
large / duże

Nyström
Pack of 12 pieces
Opak. zawiera 12 szt.
Thickness / Grubość
0.05 mm



Fig. 2 DR.808.020
premolars / przedtrzonowce



Fig. 4 DR.808.040
molars / trzonowce



Fig. 5 DR.808.050
molars / trzonowce



Fig. 6 DR.808.060
premolars / przedtrzonowce



Fig. 7 DR.808.070
molars / trzonowce

Polyester matrix band
Taśma poliestrowa gładka



DR.1100.50 8mm x 0.05mm
DR.1100.80 8mm x 0.75mm

15 mb ± 5 cm Length / Długość

Tofflemire
Pack of 12 pieces
Opak. zawiera 12 szt.
Thickness / Grubość
0.05 mm



Fig. 101 DR.810.101



Fig. 102 DR.810.102



Matrix retainers
Formówki



5 mm
DR.829.050
Falcon



DR.840.010
Tofflemire-Junior



Fig. 12
DR.830.120
Ivory



5 mm
DR.830.085
Ivory



DR.840.020
Tofflemire-Senior



DR.855.010
Matrix clamp
Zacisk do pasków



6 mm
DR.830.086
Ivory



DR.840.030
Tofflemire-Universal



7 mm
DR.830.087
Ivory



Left / Lewa
DR.832.010
Nysström



Fig. 12A
DR.830.121
Ivory



Right / Prawa
DR.832.020
Nysström

Matrix forceps
Kleszcze do formówek pierścieniowych



Falcon
DR.820.170
170 mm

Omni Matrix Disposable retainer and Matrix
Omni Matrix Jednorazowe formówki
z napinaczem



Wingless / Bez skrzydełek



Winged / Ze skrzydełkami

Stal nierdzowna	Bez skrzydełek 48 szt.	Ze skrzydełkami 48 szt.
6,5 x 0,025 mm	7701	8801
6,5 x 0,038 mm	7702	8802
5,2 x 0,038 mm	7704	8804

Stainless Steel	Wingless 48pk	Winged 48pk
6,5 x 0,025 mm	7701	8801
6,5 x 0,038 mm	7702	8802
5,2 x 0,038 mm	7704	8804



Rubber dam clamps
Klamry do koferdamu

Premolars / do zębów przedtrzonowych

Fig. 00 DR.907.000 Fig. 0 DR.907.001 Fig. 2 DR.907.020 Fig. 2A DR.907.021

Molars / do zębów trzonowych

Fig. 7 DR.907.070 Fig. 8 DR.907.080 Fig. 8A DR.907.081 Fig. 14 DR.907.140 Fig. 14A DR.907.141

Anteriors / do zębów przednich

Fig. 211 DR.907.211 Fig. 212 DR.907.212

Rubber dam clamps
Klamry do koferdamu

Fig. A DR.905.001
Molars
do zębów trzonowych

Fig. AW DR.905.002
Molars
do zębów trzonowych

Fig. BW DR.905.003
Molars
do zębów trzonowych

Fig. C DR.905.004
Incisors, canines and premolars
do zębów przednich i przedtrzonowych

Fig. DW DR.905.005
Molars
do zębów trzonowych

Fig. E DR.905.006
Incisors, canines and premolars
do zębów przednich i przedtrzonowych

Fig. EW DR.905.007
Incisors, canines and premolars
do zębów przednich i przedtrzonowych

Fig. FW DR.905.008
Molars
do zębów trzonowych

Fig. G DR.905.009
Molars
do zębów trzonowych

Fig. GW DR.905.010
Molars
do zębów trzonowych

Fig. HW DR.905.011
Molars
do zębów trzonowych

Fig. JW DR.905.012
Molars
do zębów trzonowych

Fig. K DR.905.013
Molars
do zębów trzonowych

Fig. L DR.905.014
Incisors, canines and premolars
do zębów przednich i przedtrzonowych

Fig. M DR.905.015
Incisors, canines and premolars
do zębów przednich i przedtrzonowych

Fig. NW DR.905.016
Molars
do zębów trzonowych

Fig. PW DR.905.017
Molars
do zębów trzonowych



Rubber dam clamps / Klamry do koferdamu

Anteriors / do zębów przednich



Fig. 9
DR.906.090



Fig.210
DR.906.210



Fig.211
DR.906.211



Fig.212
DR.906.212

Premolars / do zębów przedtrzonowych



Fig. 00
DR.906.100



Fig. 0
DR.906.110



Fig.1
DR.906.120



Fig.2
DR.906.130



Fig.2A
DR.906.140



Fig. 27
DR.906.020



Fig. 206
DR.906.150



Fig. 209
DR.906.180

Molars / do zębów trzonowych



Fig.3
DR.906.500



Fig.4
DR.906.510



Fig.7
DR.906.530



Fig.8
DR.906.550



Fig.8A
DR.906.560



Fig.12A
DR.906.570



Fig.13A
DR.906.580



Fig.14
DR.906.590



Fig.14A
DR.906.600



Fig.26
DR.906.370



Fig.201
DR.906.620



Fig.205
DR.906.660

Rubber dam / Koferdam



Green / Zielony
150 x 150 mm
36 sheets / 36 szt.
Mint / Miętowy zapach

DR.899.010
0.14mm
Thin / Cienki
DR.899.020
0.18mm
Medium / O średniej grubości
DR.899.030
0.22mm
Heavy / Gruby



Purple / Purpurowy
150 x 150 mm
15 sheets / 15 szt.
Mint / Miętowy zapach

DR.899.020
0.18mm
Medium / O średniej grubości

Rubber dam clamps kit with trays
Zestaw klamery do koferdamu

DR.904.020

Contents / Zawiera

DR.906.212	Anteriors fig. 212	Do zębów przednich fig. 212
DR.906.090	Anteriors fig. 9	Do zębów przednich fig. 9
DR.906.110	Premolars fig. 0	Do zębów przedtrzonowych fig. 0
DR.906.100	Premolars fig. 00	Do zębów przedtrzonowych fig. 00
DR.906.120	Premolars fig. 1	Do zębów przedtrzonowych fig. 1
DR.906.130	Premolars fig. 2	Do zębów przedtrzonowych fig. 2
DR.906.140	Premolars fig. 2A	Do zębów przedtrzonowych fig. 2A
DR.906.590	Molars fig. 14	Do zębów trzonowych fig. 14
DR.906.600	Molars fig. 14A	Do zębów trzonowych fig. 14A
DR.906.530	Molars fig. 7	Do zębów trzonowych fig. 7
DR.906.550	Molars fig. 8	Do zębów trzonowych fig. 8
DR.906.560	Molars fig. 8A	Do zębów trzonowych fig. 8A
DR.904.010	Rubber dam clamps tray	Tacka na klamry do koferdamu



DR.904.030

Contents / Zawiera

DR.905.004	Incisors, canines and premolars fig. C	Do zębów przednich i przedtrzonowych fig. C
DR.905.014	Incisors, canines and premolars fig. L	Do zębów przednich i przedtrzonowych fig. L
DR.905.015	Incisors, canines and premolars fig. M	Do zębów przednich i przedtrzonowych fig. M
DR.905.006	Incisors, canines and premolars fig. E	Do zębów przednich i przedtrzonowych fig. E
DR.905.007	Incisors, canines and premolars fig. EW	Do zębów przednich i przedtrzonowych fig. EW
DR.905.001	Molars fig. A	Do zębów trzonowych fig. A
DR.905.002	Molars fig. AW	Do zębów trzonowych fig. AW
DR.905.003	Molars fig. BW	Do zębów trzonowych fig. BW
DR.905.005	Molars fig. DW	Do zębów trzonowych fig. DW
DR.905.008	Molars fig. FW	Do zębów trzonowych fig. FW
DR.905.009	Molars fig. G	Do zębów trzonowych fig. G
DR.905.013	Molars fig. K	Do zębów trzonowych fig. K
DR.904.010	Rubber dam clamps tray	Tacka na klamry Do koferdamu



Rubber dam clamps tray
Tacka na klamry



DR.904.010
Falcon
185 x 90 x 20 mm

Rubber dam template
Szablon do koferdamu

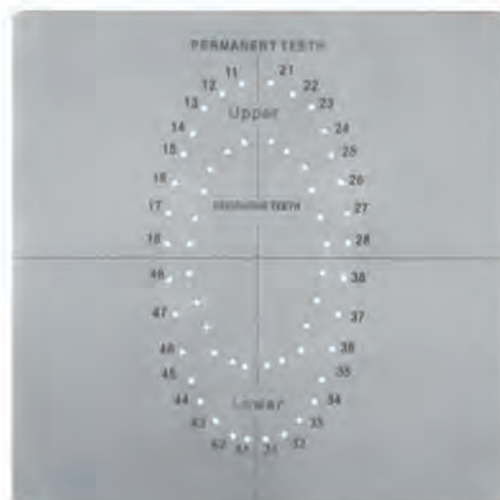

DR.948.000
Falcon
150 x 150 mm



Rubber dam frames / Ramki do koferdamu



Autoclavable
Możliwość sterylizacji w autoklawie



DR.938.110 110 mm
DR.938.130 130 mm
DR.938.150 150 mm
Young



DR.937.000 150 mm
Falcon



DR.937.010 155 x 90 mm
Falcon

Plastic rubber dam frames / Ramka do koferdamu plastikowa



DR.937.060 85 x 105mm
Young
Autoclavable at 121°C
autoklawowalna 121°C.

DR.937.080 85 x 105mm
Young
Autoclavable at 135°C
autoklawowalna 135°C.



DR.937.020
For adult / Dla dorosłych

DR.937.030
For child / Dla dzieci



DR.937.040
For child / dla dzieci 98 x 74mm
DR.937.050
For adult / dla dorosłych, 148 x 102mm

Rubber dam clamp forceps
Kleszce do klamer do koferdamu



Autoclavable
Możliwość sterylizacji w autoklawie

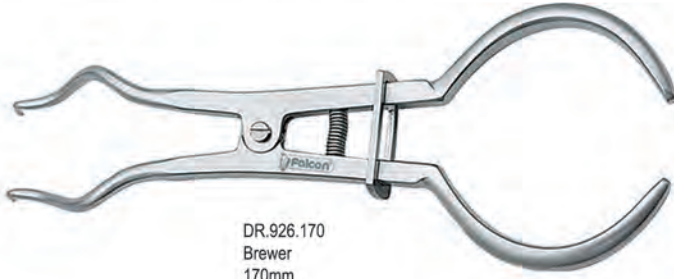

DR.926.170
Brewer
170mm



DR.928.170
IV
170mm



DR.929.170
Falcon
170mm



DR.931.170
Stokes
170mm

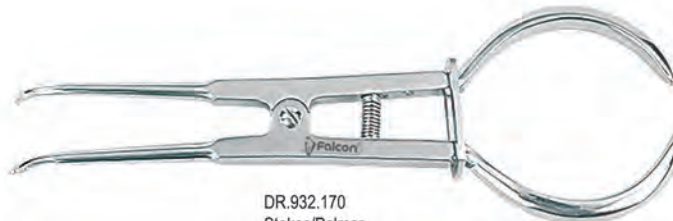

DR.932.170
Stokes/Palmer
170mm

Rubber dam punches
Dziurkacze do koferdamu



Autoclavable
Możliwość sterylizacji w autoklawie



DR.940.160
Ainsworth
160mm



DR.946.160
IV
160mm



Rubber dam instrument sets / Zestawy do koferdamu



Autoclavable
Możliwość sterylizacji w autoklawie

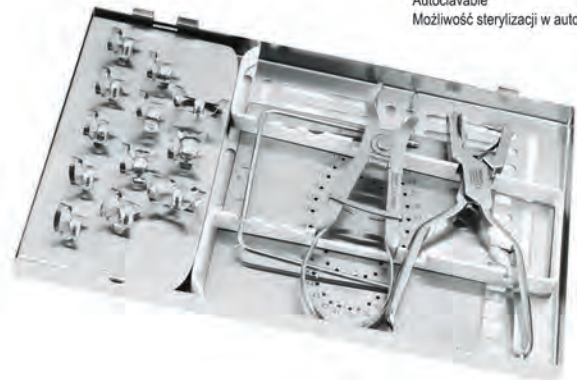

DR.900.009

Contents/ Zawiera :

Rubber dam clamps
Klamry do koferdamu

Premolars / do zębów przedtrzonowych



Fig.00
DR.906.100



Fig.0
DR.906.110



Fig.1
DR.906.120



Fig.2
DR.906.130



Fig.2A
DR.906.140

Anteriors / do zębów przednich



Fig.9
DR.906.090



Fig.212
DR.906.212

Molars / do zębów trzonowych



Fig.7
DR.906.530



Fig.8
DR.906.550



Fig.8A
DR.906.560



Fig.14
DR.906.590



Fig.14A
DR.906.600

Rubber dam clamps tray / Tacka na klamry



DR.904.010
Falcon

Rubber dam frames / Ramki do koferdamu



DR.938.130 130 mm
Young

Rubber dam clamp forceps / Kleszce do klamer do koferdamu



DR.928.170
IV
170mm

Rubber dam template / Szablon do koferdamu



DR.948.000

Latex rubber dam / Koferdam z lateksu



DR.899.020
0.18mm
Medium / O średniej grubości
Green / Zielony
150 x 150 mm
36 sheets / 36 szt.
Mint / Miętowy zapach

Rubber dam punches / Dziurkacz do koferdamu

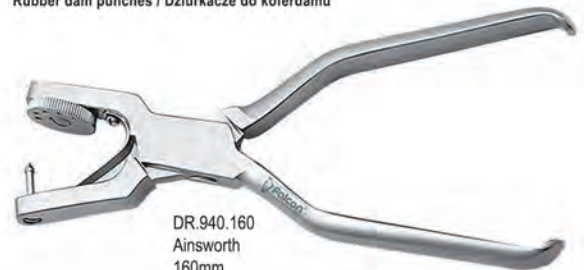

DR.940.160
Ainsworth
160mm

Sterilization cassettes / Kasetki do sterylizacji z zamkiem

Suitable for ultrasonic baths, disinfectors, autoclaves
Pasują do myjek ultradźwiękowych, dezynfektorów, autoklawów.



DZ.086.030
288 x 182x 34 mm



Rubber dam instrument sets / Zestawy do koferdamu



DR.900.006
Contents/ Zawiera :

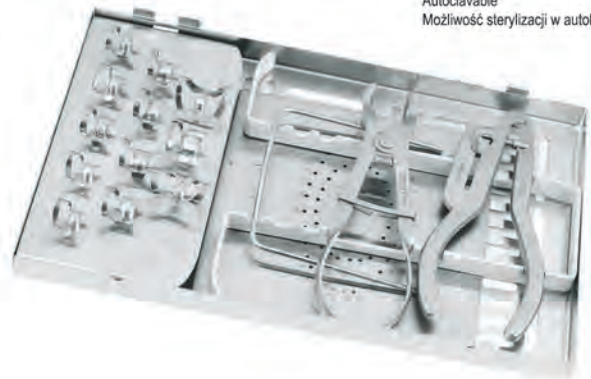

Autoclavable
Możliwość sterylizacji w autoklawie

Rubber dam clamps
Klamry do koferdamu

Premolars / do zębów przedtrzonowych



Fig.00
DR.906.100



Fig.0
DR.906.110



Fig.1
DR.906.120



Fig.2
DR.906.130



Fig.2A
DR.906.140

Anteriors / do zębów przednich



Fig.9
DR.906.090



Fig.212
DR.906.212

Molars / do zębów trzonowych



Fig.7
DR.906.530



Fig.8
DR.906.550



Fig.8A
DR.906.560



Fig.14
DR.906.590



Fig.14A
DR.906.600

Rubber dam clamps tray / Tacka na klamry



DR.904.010
Falcon

Rubber dam frames / Ramki do koferdamu



DR.938.130 130 mm
Young

Rubber dam clamp forceps / Kleszeczki do klamer do koferdamu



DR.928.170
IV
170mm

Rubber dam punches / Dziurkaczki do koferdamu

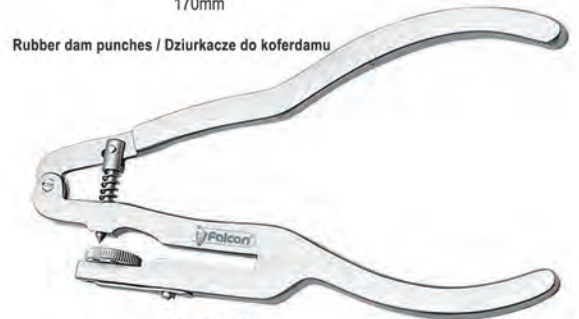

DR.946.160
IV
160mm

Rubber dam template / Szablon do koferdamu



DR.948.000

Latex rubber dam / Koferdam z lateksu



DR.899.020
0.18mm
Medium / O średniej grubości
Green / Zielony
150 x 150 mm
36 sheets / 36 szt.
Mint / Miętowy zapach

Sterilization cassettes / Kasetki do sterylizacji z zamkiem

Suitable for ultrasonic baths, disinfectors, autoclaves
Pasują do myjek ultradźwiękowych, dezynfektorów, autoklawów.



DZ.086.030
288 x 182x 34 mm



Rubber dam instrument sets / Zestawy do koferdamu



Autoclavable
Możliwość sterylizacji w autoklawie



DR.900.007
Contents/ Zawiera :



Rubber dam clamps / Klamry do koferdamu



Fig. A
DR.905.001
Molars
do zębów trzonowych



Fig. C
DR.905.004
Incisors, canines and premolars
do zębów przednich i przedtrzonowych



Fig. E
DR.905.006
Incisors, canines and premolars
do zębów przednich i przedtrzonowych



Fig. FW
DR.905.008
Molars
do zębów trzonowych



Fig. G
DR.905.009
Molars
do zębów trzonowych



Fig. K
DR.905.013
Molars
do zębów trzonowych



Fig. L
DR.905.014
Incisors, canines and premolars
do zębów przednich i przedtrzonowych



Fig. M
DR.905.015
Incisors, canines and premolars
do zębów przednich i przedtrzonowych

Rubber dam clamps tray / Tacka na klamry



DR.904.010
Falcon

Rubber dam frames / Ramki do koferdamu



DR.938.130 130 mm
Young

Rubber dam clamp forceps / Kleszcze do klamer do koferdamu

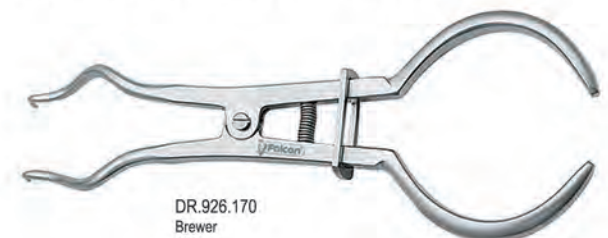

DR.926.170
Brewer
170mm

Rubber dam template / Szablon do koferdamu



DR.948.000

Latex rubber dam / Koferdam z lateksu



DR.899.020
0,18mm
Medium / O średniej grubości
Green / Zielony
150 x 150 mm
36 sheets / 36 szt.
Mint / Miętowy zapach

Rubber dam punches / Dziurkacze do koferdamu



DR.940.160
Ainsworth
160mm

Sterilization cassettes / Kasetki do sterylizacji z zamkiem
Suitable for ultrasonic baths, disinfectors, autoclaves
Pasują do myjek ultradźwiękowych, dezynfektorów, autoklawów.



DZ.086.030
288 x 182x 34 mm

D₉

Anaesthesia / Anestezjologia





Stainless steel series
Made of 18-8 stainless steel
Longer life than Brass syringes
No chipping of chrome
Guaranteed quality
Sterilizable by any method

SS•2000
Stainless Steel Series

Seria z nierdzewnej stali
Wykonane ze stali nierdzewnej 18-8
Większa wytrzymałość niż Brass syringes (strzykawki z mosiądzu)
Powłoka odporna na uszkodzenia
Gwarancja jakości
Możliwość sterylizacji wszystkimi sposobami

Intraligamental syringes / Strzykawki śródwładłowe



Injects 0.05 ml with every click
Supplied with angled and straight tubes
Jednorazowa iniekcja 0,05 ml.
Tulejka z prostym i kątowym gwintem igły

DA.010.180
Falcon-Ject Ultima
1,8 ml.



Injects 0.06 ml with every click
Jednorazowa iniekcja 0,06 ml.

DA.021.180
Falcon-Ject straight / z gwintem prostym
1,8ml.



Injects 0.06 ml with every click
Jednorazowa iniekcja 0,06 ml.

DA.020.180
Falcon-Ject angled / z gwintem kątowym
1,8ml.



Injects 0.06 ml with every click
Jednorazowa iniekcja 0,06 ml.

DA.094.180
Swedish Type / Typ Szwedzki
1,8 ml.

Stainless steel series
Made of 18-8 stainless steel
Longer life than Brass syringes
No chipping of chrome
Guaranteed quality
Sterilizable by any method

SS·2000
Stainless Steel Series

Seria z nierdzewnej stali
Wykonane ze stali nierdzewnej 18-8
Większa wytrzymałość niż Brass syringes (strzykawki z mosiądzu)
Powłoka odporna na uszkodzenia
Gwarancja jakości
Możliwość sterylizacji wszystkimi sposobami

Dual aspiration system, self and manual aspirating syringes
System podwójnej aspiracji, strzykawki z autoaspiracją i aspiracją ręczną

During injection, aspiration can be achieved either manually by retracting the plunger backward or simply releasing pressure on plunger will produce self aspiration.

Podczas iniekcji aspiracja może zachodzić automatycznie poprzez zwolnienie nacisku kciuka na tłoczek, lub ręcznie poprzez odcignięcie tłoczka.



DA.517.180
Type A / Typ-A
1,8 ml.



DA.557.180
Type C / Typ-C
1,8 ml.

Manual aspirating syringes / Strzykawki z aspiracją ręczną



DA.595.180
Euro / Typ Euro
1,8 ml.



DA.635.180
T-Handle / Typ z uchwytem T
1,8 ml.



DA.705.180
3-Ring / Typ 3-Koła
1,8ml.

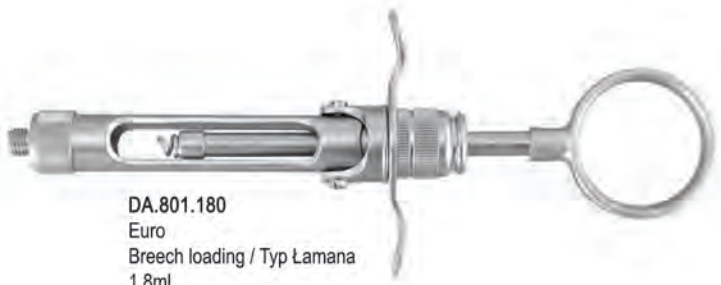

DA.801.180
Euro
Breech loading / Typ Łamana
1,8ml.

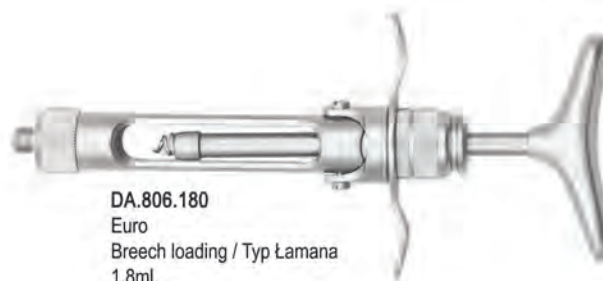

DA.806.180
Euro
Breech loading / Typ Łamana
1,8ml.



Made of Brass
Chrome plated
All Brass series syringes have stainless steel plungers
Guaranteed quality
Sterilizable by any method

**Brass
SERIES**

Strzykawki wykonane z mosiądzu
Kryte warstwą chromową
Wszystkie strzykawki Brass series posiadają tłoczki ze stali nierdzewnej
Gwarancja jakości
Możliwość sterylizacji wszystkimi sposobami

Intraligamental syringes / Strzykawki śródwiązadłowe



Injects 0.20 ml with every click
Lever action for high injection pressure

Jednorazowa iniekcja 0,20 ml.
Dźwignia do iniekcji zwiększająca ciśnienie

DA.060.180
Pistol-Ject
1,8ml.



Injects 0.06 ml with every click
Jednorazowa iniekcja 0,06 ml.

DA.095.180
Swedish Type / Typ Szwedzki
1,8ml.

Plastic protection tube / Plastikowa tuba ochronna



DA.035.000
Autoclavable / Możliwość sterylizacji w autoklawie

Manual aspirating syringes / Strzykawki z aspiracją ręczną



DA.520.180
Type A / Typ-A
1,8ml.



DA.560.180
Type C / Typ-C
1,8ml.



DA.620.180
Euro / Typ Euro
1,8ml.



DA.721.180
3- Ring / Typ 3-Koła
1,8ml.



Made of Brass
Chrome plated
All Brass series syringes have stainless steel plungers
Guaranteed quality
Sterilizable by any method

Brass
SERIES

Strzykawki wykonane z miedzi
Kryte warstwą chromową
Wszystkie strzykawki Brass series posiadają tłoczki ze stali nierdzewnej
Gwarancja jakości
Możliwość sterylizacji wszystkimi sposobami

Manual aspirating syringes / Strzykawki z aspiracją ręczną



DA.735.180
2-Ring / Typ 2-Kola
1,8ml.

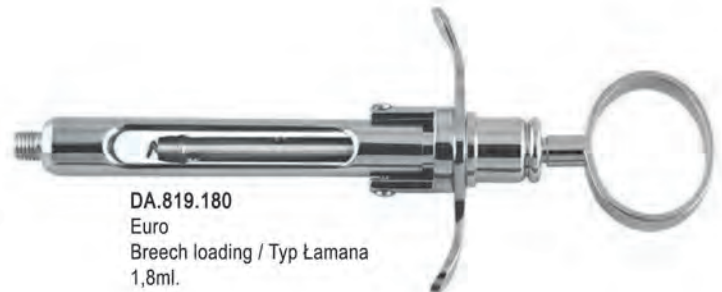

DA.819.180
Euro
Breech loading / Typ Łamana
1,8ml.

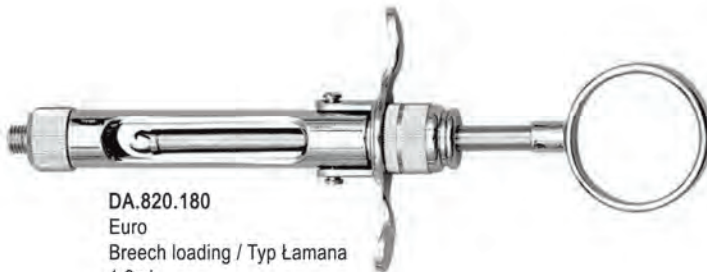

DA.820.180
Euro
Breech loading / Typ Łamana
1,8ml.

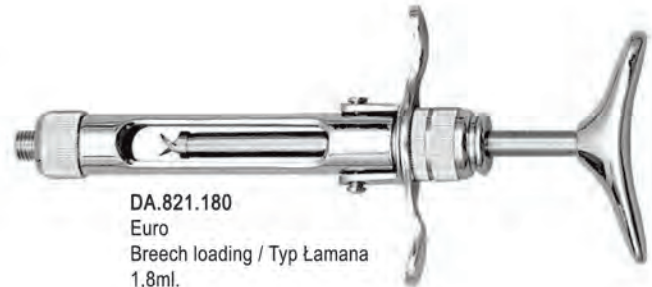

DA.821.180
Euro
Breech loading / Typ Łamana
1,8ml.



DA.822.180
Euro
Breech loading / Typ Łamana
1,8ml.

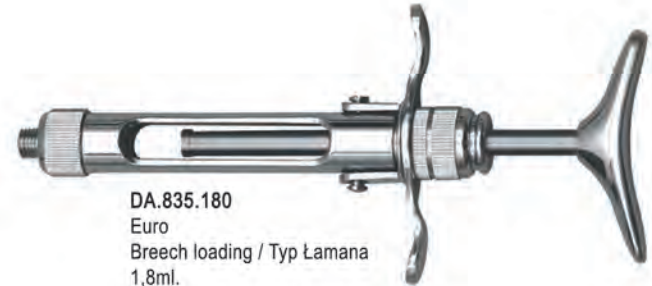

DA.835.180
Euro
Breech loading / Typ Łamana
1,8ml.

P-Ject

Manual aspirating syringe
Strzykawka z aspiracją ręczną

Special aspiration tip / Specjalna końcówka do aspiracji



DA.561.180
1,8 ml

Disposable Dental needles, Sterile
Jednorazowe igły do znieczuleń sterylne

Sterile, thread in compliance with European standard
Sterylne, gwint w zgodności z europejskim standardem
do strzykawkę typu karpula



DA.1000.12 0,3 x 12 mm
DA.1000.16 0,3 x 16 mm
DA.1000.21 0,3 x 21 mm
DA.1000.25 0,3 x 25 mm
DA.1001.25 0,4 x 25 mm
DA.1001.36 0,4 x 36 mm

Pack of 100 pieces / Opak. 100 szt.

Self aspirating syringes / Strzykawki z autoaspiracją

Self aspiration: How it works

During use, the thumb pressure on the plunger or thumb disc stretches the diaphragm over a small metal projection inside of the syringe nozzle, increasing pressure inside of the cartridge. As the thumb pressure is released, pressure inside the cartridge lessens and aspiration occurs automatically. (Instruction for use are supplied with the product)

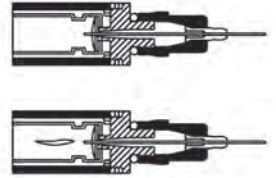

Autoaspiracja - sposób działania

Nacisk kciuka na tłoczek powoduje naprężenie membrany nad drobnym metalowym elementem wewnątrz tulejki strzykawki, zwiększając ciśnienie w pojemniku wkładu. Zwalniając tłoczek, ciśnienie wewnątrz wkładu zmniejsza się i aspiracja zachodzi automatycznie. (Instrukcja dołączona jest do produktu).

Disc system syringes

Dual self aspiration system:

Disc system syringe has dual aspiration feature to achieve self aspiration.

Aspiration before injection:

Insert syringe in tissue and press thumb disc to achieve aspiration.

Aspiration during injection:

Automatic aspiration occurs whenever pressure on the plunger is released.

Strzykawki disc system

System podwójnej autoaspiracji:

Strzykawka z metalowym krążkiem pozwala na podwójną aspirację.

Aspiracja przed iniekcją:

Wprowadzić igłę w tkankę i nacisnąć tłoczek w celu uzyskania aspiracji.

Aspiracja w trakcie iniekcji:

Aspiracja zachodzi automatycznie, kiedy ustaje nacisk na tłoczek.



DA.115.180
Disc system
1,8ml.



DA.145.180
Disc system
1,8ml.

Projection system syringes

Aspiration during injection:

Automatic aspiration occurs whenever pressure on the plunger is released.

Strzykawki projection system

Aspiracja w trakcie iniekcji:

Aspiracja zachodzi automatycznie, kiedy ustaje nacisk na tłoczek.



DA.315.180
Projection system
1,8ml.

Needle re-cappers / Bezpieczniki do igieł

Ultima

Needle re-capper / Bezpiecznik do igieł

Falcon Needle Re-Cappers are the ideal way to prevent needle stick injuries when recapping needles. Place the upturned needle cap into Falcon Re-Capper and re-sheathing becomes a simple one hand procedure.

Tulejki do nakładania skuwek na igły do iniekcji są idealnym rozwiązaniem zapobiegającym przypadkowym skażeniom podczas nakładania skuwki na igłę. Po włożeniu skuwki w stojącą tulejkę, zamykanie igły staje się łatwą i bezpieczną czynnością, którą można wykonać jedną ręką.



SS-2000
Stainless Steel Series



DA.990.000

SS-2000
Stainless Steel Series



DA.980.000

D₁₀

Extraction / Ekstrakcja



Instrument Sets for Extraction and Oral Surgery
Zestawy instrumentów do ekstrakcji i chirurgii



DE.999.001
Set of 9 pieces / Zestaw 9 szt.

Contents / Zawiera:

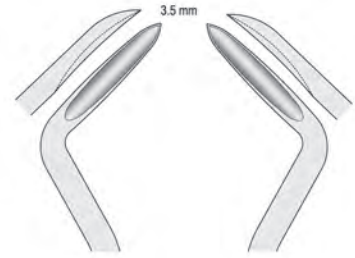

Fig. 2
DE.086.020
Flohr

Fig. 3
DE.086.030
Flohr



Fig. 6
DE.025.060
Bein

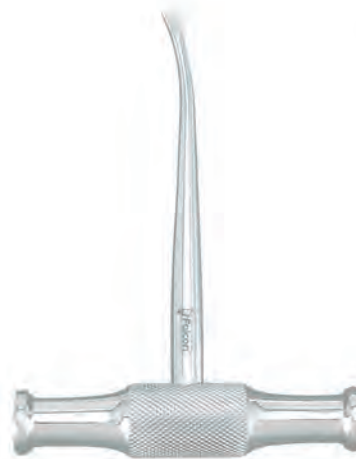

Fig. 12L
DE.270.125
Winter



Fig. 12R
DE.270.127
Winter



Fig. 33A
DE.750.331

Standard / Standardowe

Lower roots narrow tips
do korzeni dolnych wąskie

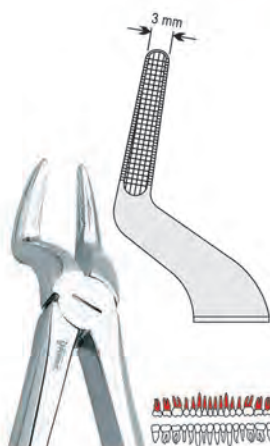

Fig. 51A
DE.750.511

Upper roots narrow tips
do korzeni górnych wąskie

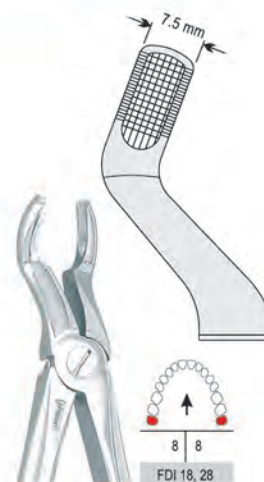

Fig. 67A
DE.750.671

Upper third molars
do zębów mądrości górnych

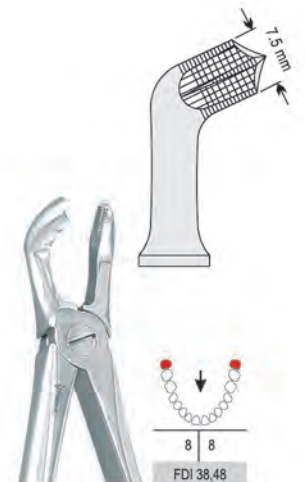

Fig. 79
DE.750.790

Lower third molars
do zębów mądrości dolnych

Instrument Sets for Extraction and Oral Surgery
Zestawy instrumentów do ekstrakcji i chirurgii

Contents / Zawiera:



DE.999.002
Set of 9 pieces / Zestaw 9 szt.

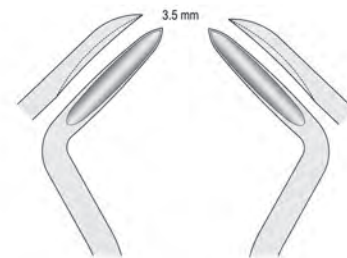

Fig. 2
DE.086.020
Flohr

Fig. 3
DE.086.030
Flohr



Fig. 6
DE.025.060
Bein

Falcon
GRIP
With tungsten carbide inserts
Con punte al carburo di tungsteno
Z wkładką z węgla spiekanego



0.5
BN.298.160
160 mm / 6 1/4"

Mayo-Hegar



0.4
BN.414.140
140 mm / 5 1/2"

Mathieu



Fig. 33A
DE.750.331

Standard / Standardowe

Lower roots narrow tips
do korzeni dolnych wąskie



Fig. 51A
DE.750.511

Upper roots narrow tips
do korzeni górnych wąskie

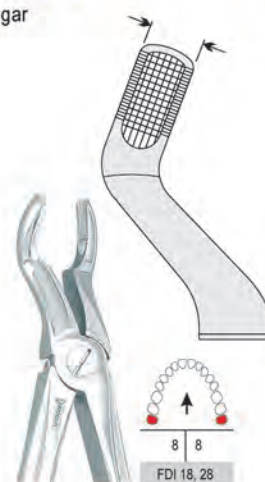

Fig. 67A
DE.750.671

Upper third molars
do zębów mądrości górnych

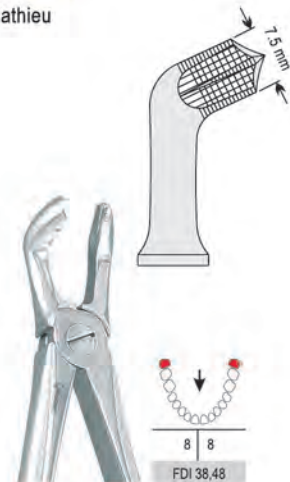

Fig. 79
DE.750.790

Lower third molars
do zębów mądrości dolnych



Ergo-form Elevators

- **Tips are made of special grade stainless steel and are TIN coated:**
Benefits:
Edge stays sharp longer
Longer life than ordinary stainless steel elevators
Improved smoothness for easy sliding in and out
Non toxic TIN coating
- **Available in new and existing best selling models**
- **Końcówki pokryte azotkiem tytanu oraz wykonane z wysokiej jakości stali nierdzewnej:**
Cechy:
Krawędzie pozostają dłużej ostre
Dłuższa wytrzymałość od dźwigni ze stali nierdzewnej
Udoskonalona gładkość dla łatwiejszego stosowania
Pokryte nietoksycznym azotkiem tytanu
- **Dostępne w nowych i najpopularniejszych modelach**



Falcon Serrated / Ząbkowane

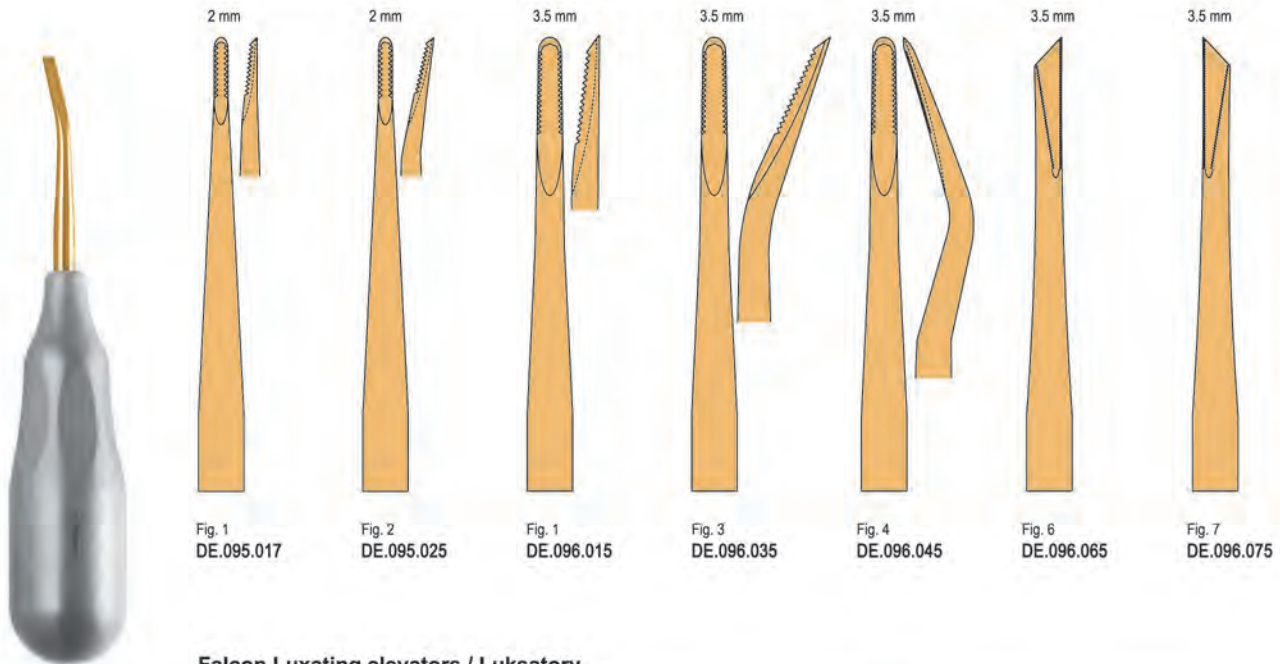

Falcon Luxating elevators / Luksatory

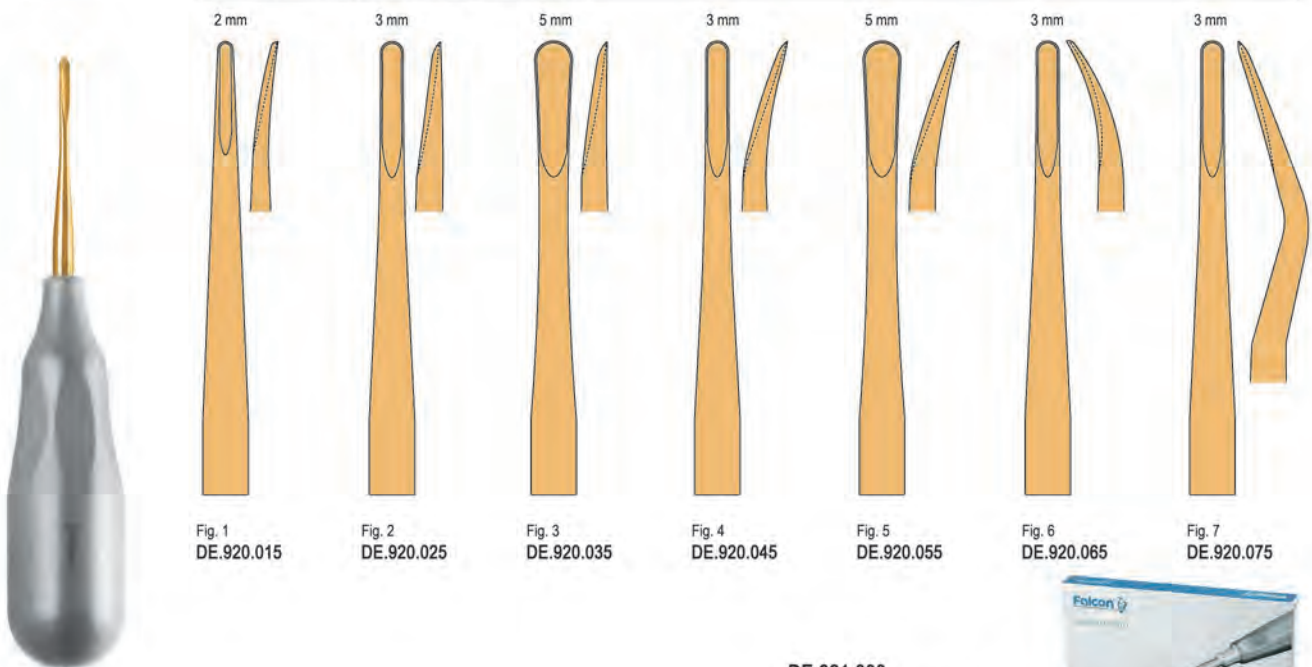

DE.921.000
Luxation set of 7 pieces
Zestaw luksatorów zawiera 7 szt.



European models / Modele Europejskie

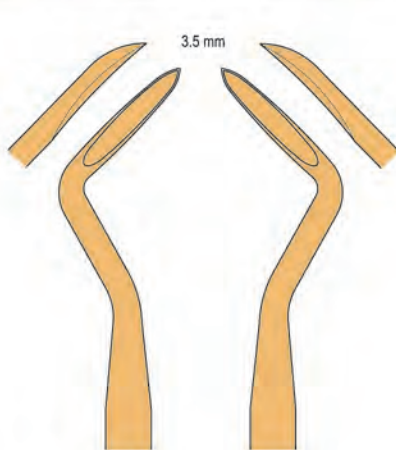

Fig. 2
DE.086.025
Flohr

Fig. 3
DE.086.035
Flohr



Fig. 1
DE.025.015
Bein



Fig. 6
DE.025.065
Bein



Fig. 7
DE.025.075
Bein

British models / Modele Angielskie

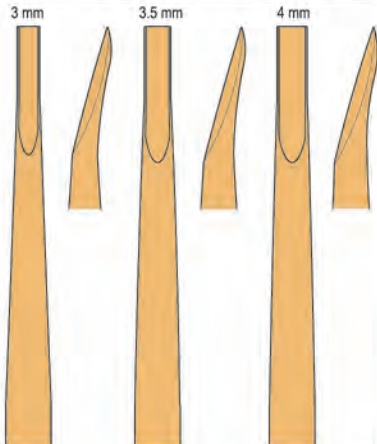

Fig. 1
DE.050.015
Coupland

Fig. 2
DE.050.025
Coupland

Fig. 3
DE.050.035
Coupland

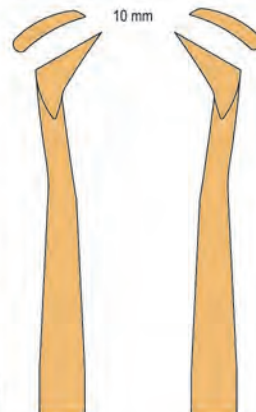
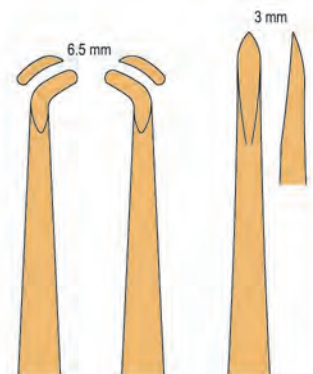

Fig. 30
DE.060.305
Cryer

Fig. 31
DE.060.315
Cryer



DE.190.055
Warwick-James

DE.190.075
Warwick-James

DE.190.085
Warwick-James

Root tip elevators / Dźwignie do korzeni



Fig. 1
DE.290.015
Heidebrink

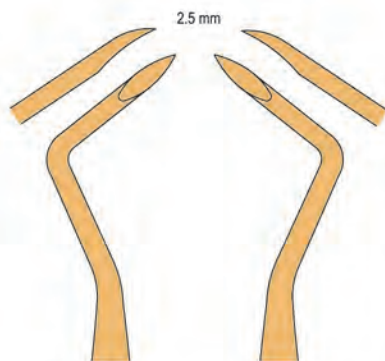

Fig. 2
DE.290.025
Heidebrink

Fig. 3
DE.290.035
Heidebrink



Fig. 11
DE.285.115
Bernhard

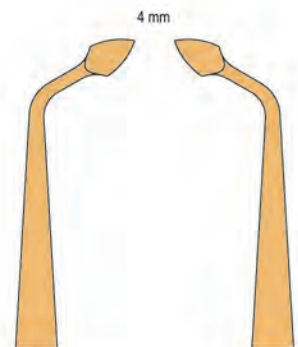
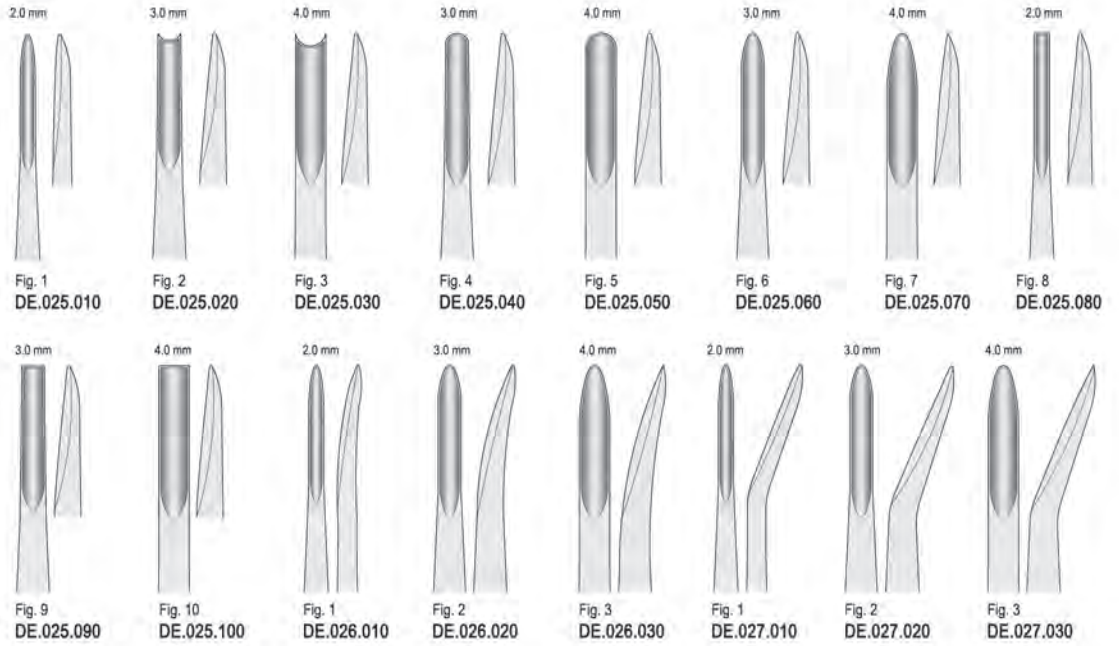

Fig. 6
DE.285.065
Bernhard

Fig. 7
DE.285.075
Bernhard

Elevators Bein / Dźwignie Bein



Elevators bayonet Bein / Dźwignie Bein bagnetowe

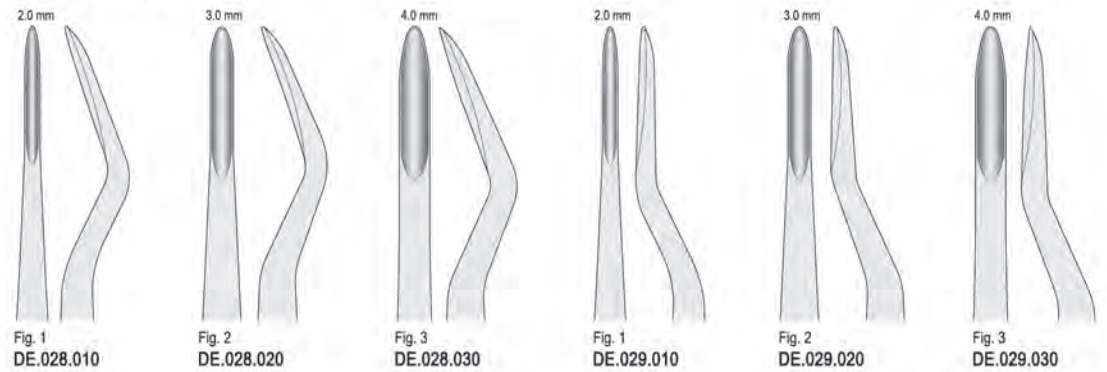

Elevators / Dźwignie

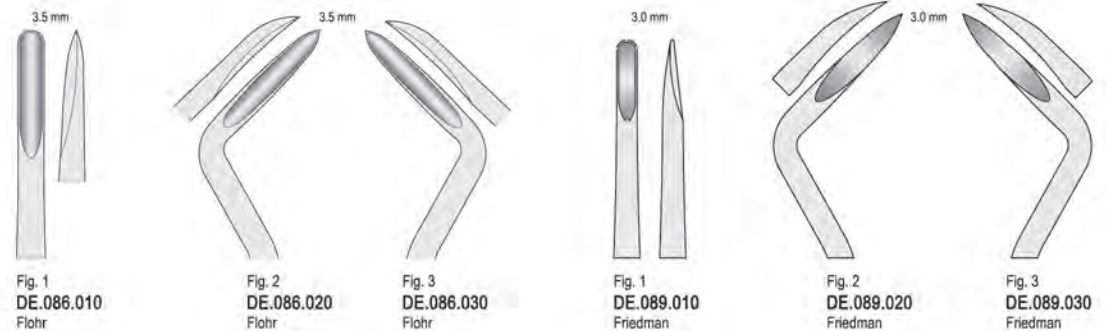



**Elevators
Dźwignie**

Bein

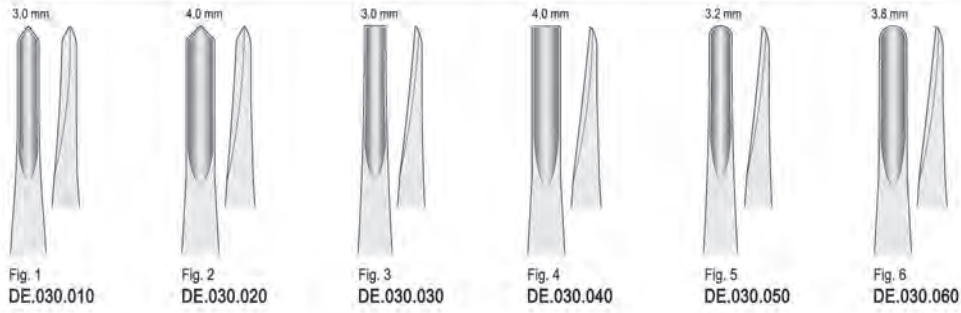

Apical

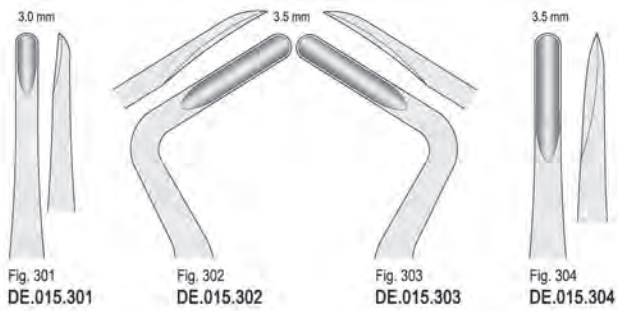

Seldin

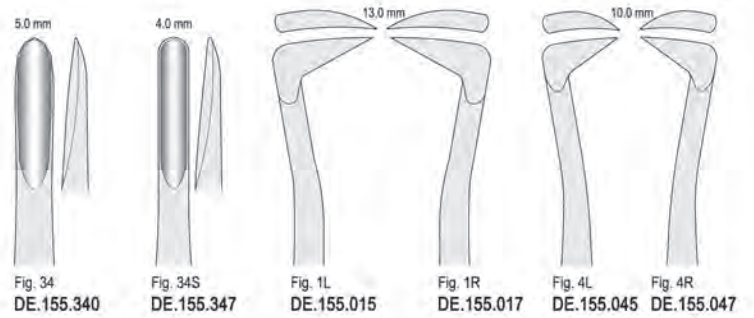

Coupland



Cryer

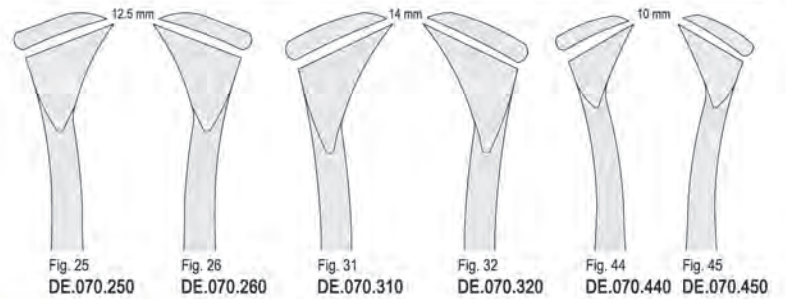

**Elevators Hylin
Dźwignie Hylin**

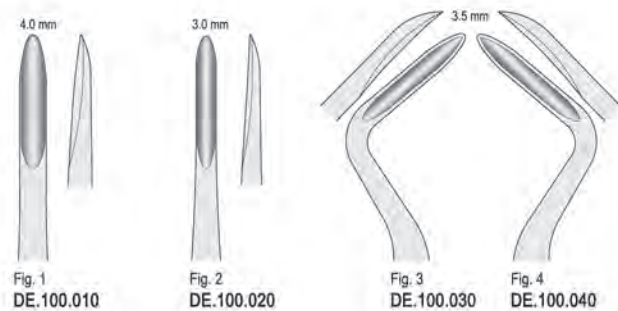

**Elevators Schmeckebier
Dźwignie Schmeckebier**

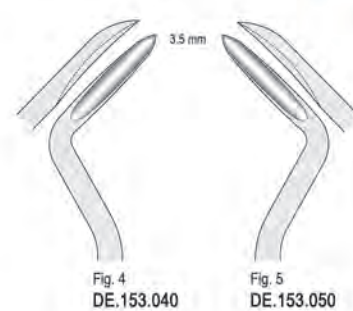



Elevators / Dźwignie

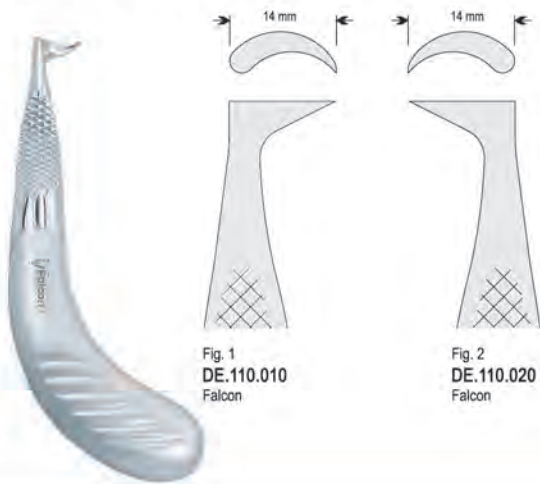

Fig. 1
DE.110.010
Falcon

Fig. 2
DE.110.020
Falcon

Elevators / Dźwignie



Fig. 1
DE.154.010
Schlemmer

Fig. 2
DE.154.020
Schlemmer

Elevators / Dźwignie

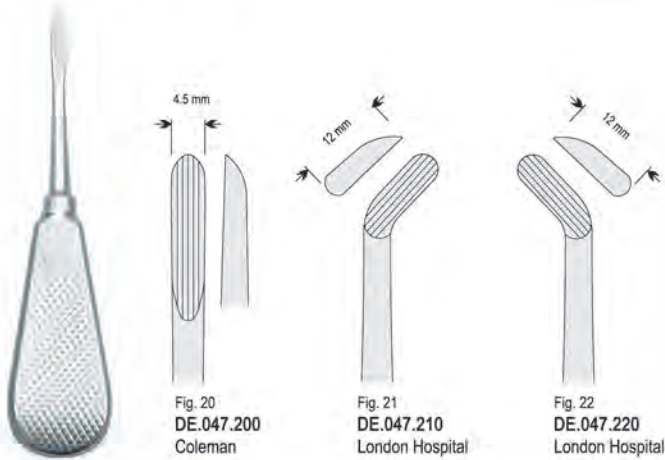
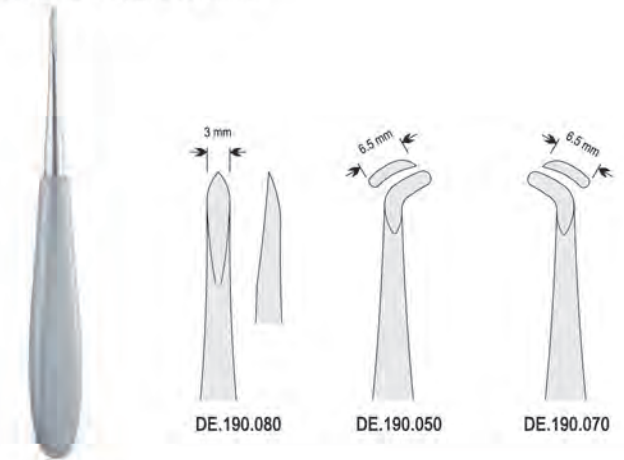

Fig. 20
DE.047.200
Coleman

Fig. 21
DE.047.210
London Hospital

Fig. 22
DE.047.220
London Hospital

**Elevators Warwick-James
Dźwignie Warwick-James**



DE.190.080

DE.190.050

DE.190.070

**Elevators Lindo-Levian serrated
Dźwignie Lindo-Levian ząbkowane**

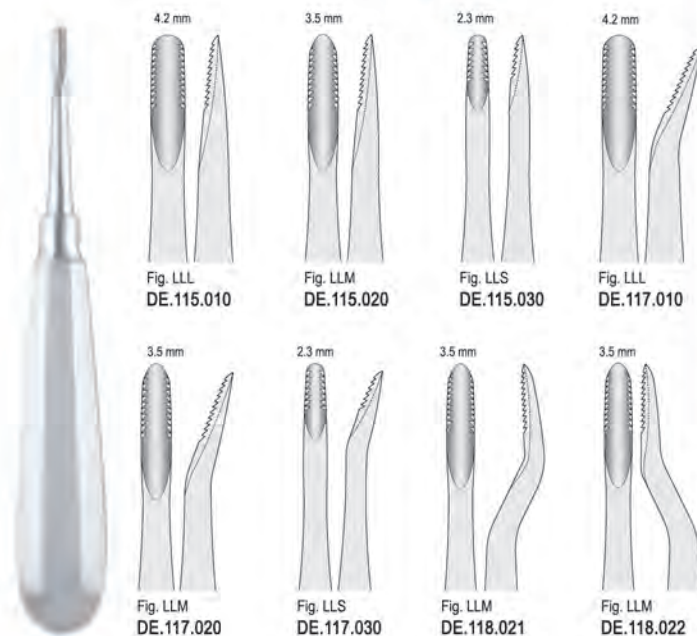

Fig. LLL
DE.115.010

Fig. LLM
DE.115.020

Fig. LLS
DE.115.030

Fig. LLL
DE.117.010

Fig. LLM
DE.117.020

Fig. LLS
DE.117.030

Fig. LLM
DE.118.021

Fig. LLM
DE.118.022

**Elevators with anatomical handle
Dźwignie-uchwyt anatomiczny**

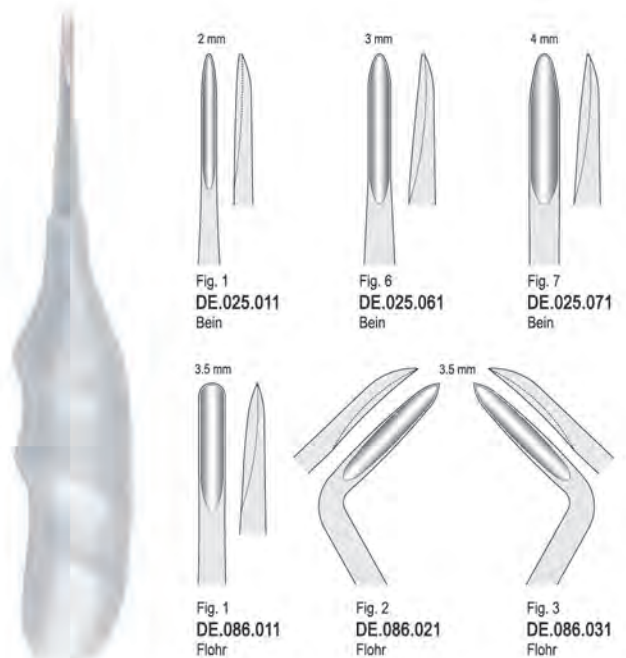

Fig. 1
DE.025.011
Bein

Fig. 6
DE.025.061
Bein

Fig. 7
DE.025.071
Bein

Fig. 1
DE.086.011
Flohr

Fig. 2
DE.086.021
Flohr

Fig. 3
DE.086.031
Flohr

Elevator Lecluse / Dźwignia Lecluse

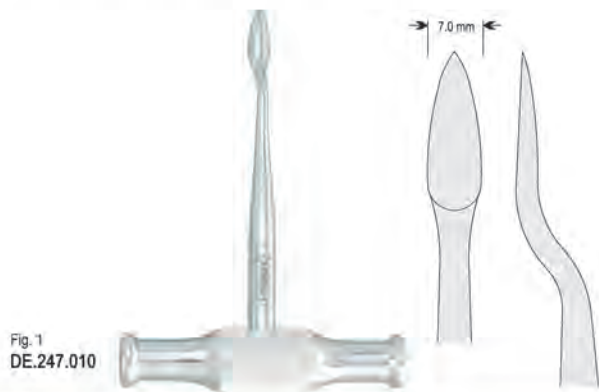

Elevators Potts / Dźwignie Potts

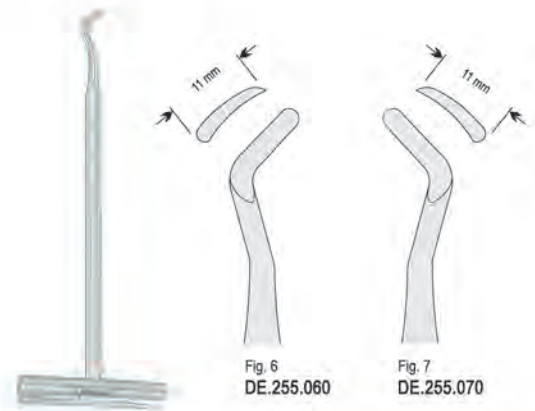

Elevators Winter / Dźwignie Winter

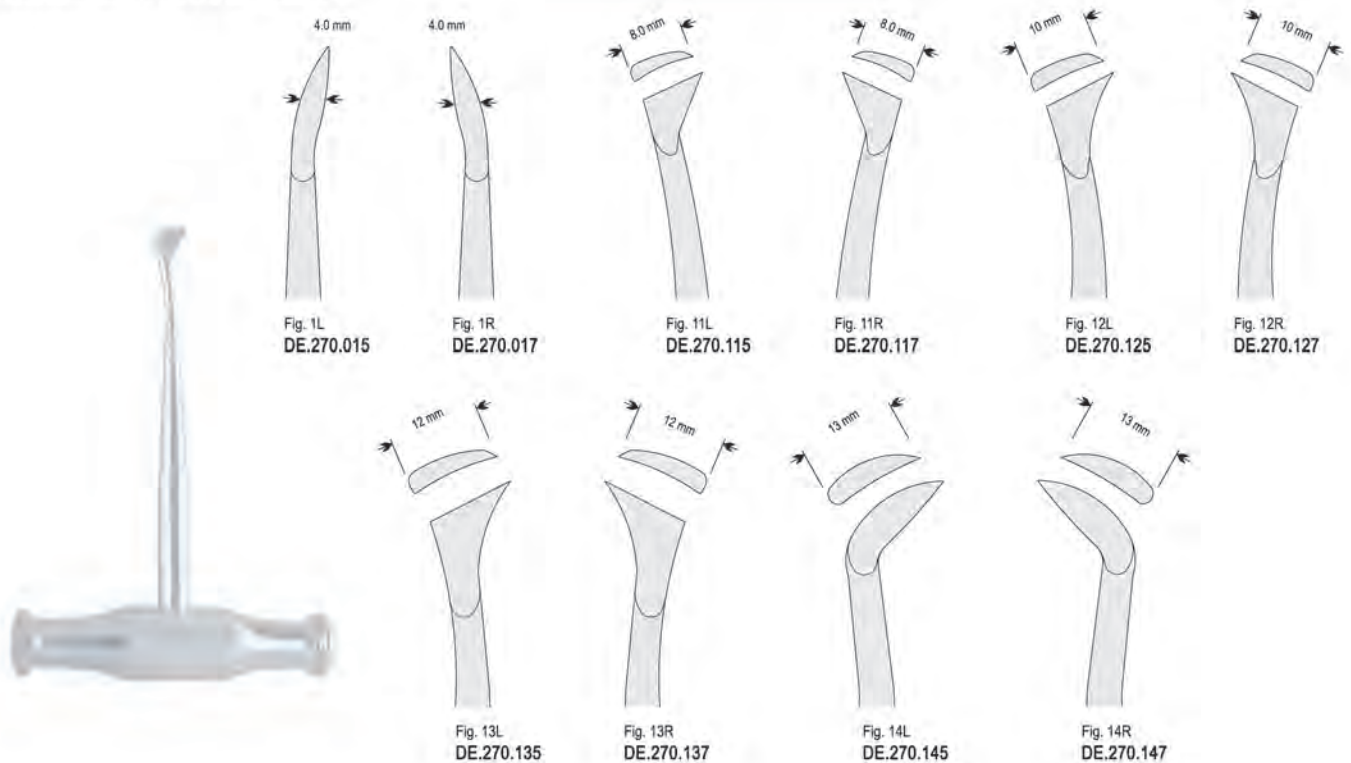

Elevators Walter F. Barry / Dźwignie Walter F. Barry

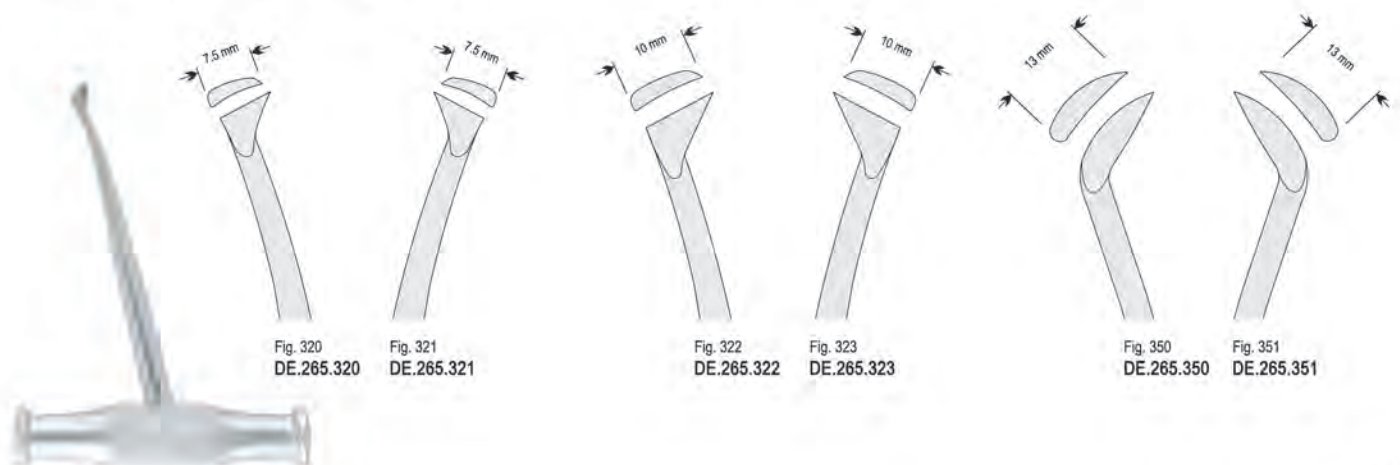

Elevators Luxation / Dźwignie Luksator



Fig. 1
DE.920.010



Fig. 2
DE.920.020



Fig. 3
DE.920.030



Fig. 4
DE.920.040



Fig. 5
DE.920.050



Fig. 6
DE.920.060



Fig. 7
DE.920.070



DE.920.000
Set of 7 pieces
Zestaw zawiera 7 szt.

Elevators root tip Heidebrink / Dźwignie do korzeni Heidebrink

CLASSIC-LITE

10 mm hollow handle
10 mm pusty uchwyt



Fig. 1
DE.290.011

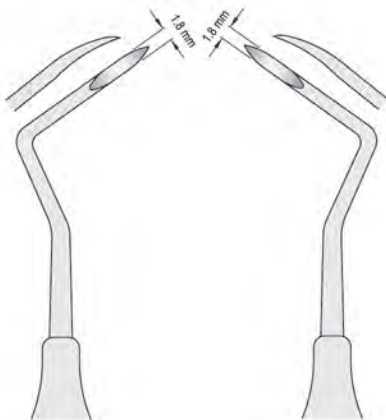

Fig. 2
DE.290.021

Fig. 3
DE.290.031

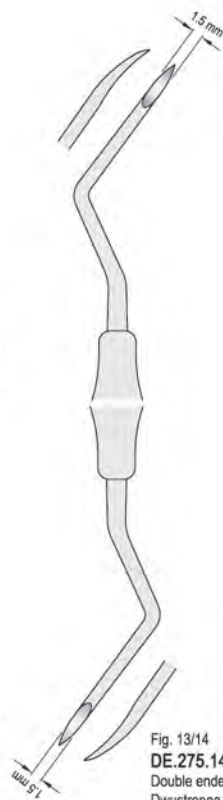

Fig. 13/14
DE.275.145
Double ended
Dwustronna



Fig. 1
DE.290.010



Fig. 2
DE.290.020

Fig. 3
DE.290.030

Syndesmotomes
Syndesmotomy

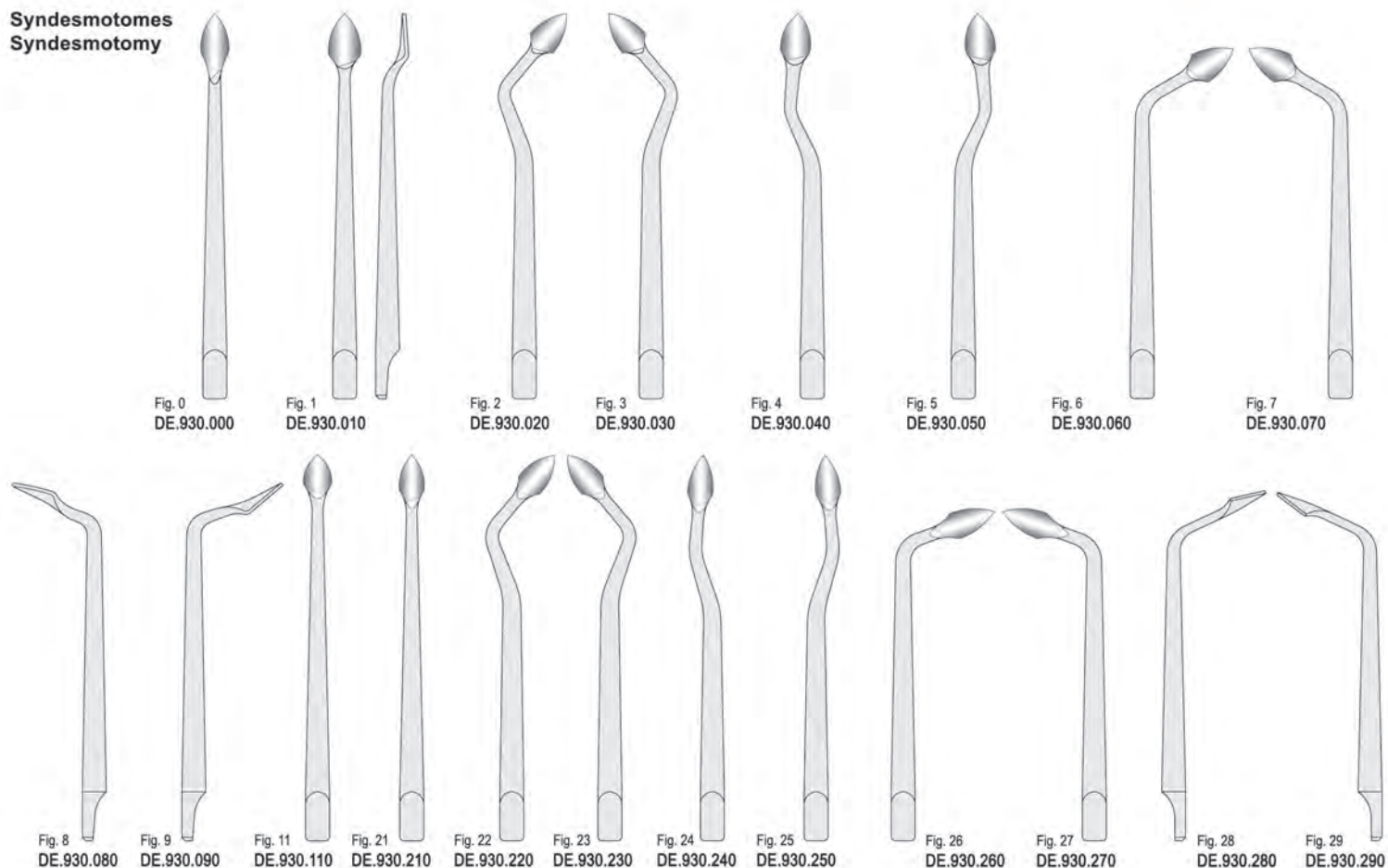

Fig. 0
DE.930.000

Fig. 1
DE.930.010

Fig. 2
DE.930.020

Fig. 3
DE.930.030

Fig. 4
DE.930.040

Fig. 5
DE.930.050

Fig. 6
DE.930.060

Fig. 7
DE.930.070

Fig. 8
DE.930.080

Fig. 9
DE.930.090

Fig. 11
DE.930.110

Fig. 21
DE.930.210

Fig. 22
DE.930.220

Fig. 23
DE.930.230

Fig. 24
DE.930.240

Fig. 25
DE.930.250

Fig. 26
DE.930.260

Fig. 27
DE.930.270

Fig. 28
DE.930.280

Fig. 29
DE.930.290



DE.929.010
Syndesmotomes handle
Uchwyt do syndesmotomu
110 mm



DE.931.010
Set of 11 tips and 1 handle in box
Zestaw 11 Końcówek + 1 Uchwyt
(Fig. 0,1,2,3,4,5,6,7,8,9,11)

DE.931.020
Set of 20 tips and 1 handle in box
Zestaw 20 Końcówek + 1 Uchwyt
(Fig. 0,1,2,3,4,5,6,7,8,9,11,21,
22,23,24,25,26,27,28,29)

Syndesmotomes Chompret
Syndesmotomy Chompret



Fig. 1
DE.925.010

Fig. 2
DE.925.020

Fig. 3
DE.925.030

Fig. 4
DE.925.040



Elevators / Dźwignia



Falcon Mini



Fig. 1
DE.080.010



Fig. 2
DE.080.020



Fig. 3
DE.080.030

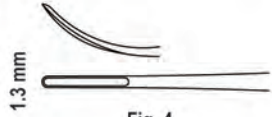

Fig. 4
DE.080.040

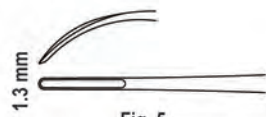

Fig. 5
DE.080.050

Luxating hybrids / Luksatory perio mikro-ząbkowane



DE.917.010
Straight
Prosty
2.5 mm



DE.917.020
Curved
Zagięty
2.5 mm



DE.917.030
Bayonet distal
Bagnetowy dystalny
2.5 mm



DE.917.040
Bayonet mesial
Bagnetowy mezjalny
2.5 mm



DE.917.050
Bayonet distal
Bagnetowy dystalny
4 mm



DE.917.060
Bayonet mesial
Bagnetowy mezjalny
4.0 mm



DE.917.070
Straight Bernhard
Bernhard prosty
3.5 mm

Disguise Extraction forceps children pattern
Disguise Kleszce ekstrakcyjne dla dzieci



Fig. 3
DE.660.030
Upper Molars
do zębów
trzonowych
górných



Fig. 5
DE.660.050
Lower Incisors
do zębów
przednich
dolnych



Fig. 6
DE.660.060
Lower Molars
do zębów
trzonowych
dolnych



Fig. 7
DE.660.070
Lower Roots
do korzeni
dolnych



Fig. 137
DE.661.370
Upper Incisors
do zębów
przednich
górných



Fig. 51S
DE.660.517
Upper Roots
do korzeni
górných

Disguise Extraction forceps set
Disguise Zestaw kleszczy ekstrakcyjnych



Fig. 139
DE.661.390
Upper Premolars
do zębów
przedtrzonowych
górných



- DE.660.000**
Contents 7 pieces
Zawiera 7 sztuk
- DE.660.030** Fig. 3
 - DE.660.050** Fig. 5
 - DE.660.060** Fig. 6
 - DE.660.070** Fig. 7
 - DE.660.517** Fig. 51S
 - DE.661.370** Fig. 137
 - DE.661.390** Fig. 139

Extraction forceps children pattern / Kleszcze ekstrakcyjne dla dzieci



Fig. 13S
DE.500.137
Lower Premolars
do zębów przedtrzonowych dolnych



Fig. 22S
DE.500.227
Lower Molars
do zębów trzonowych dolnych



Fig. 30S
DE.500.307
Upper Roots
do korzeni górnych



Fig. 33S
DE.500.337
Lower Roots
do korzeni dolnych



Fig. 37
DE.500.370
Upper Incisors
do zębów przednich górnych



Fig. 38
DE.500.380
Lower Incisors and Canines
do zębów przednich dolnych



Fig. 39
DE.500.390
Upper Molars
do zębów trzonowych górnych



Fig. 39L
DE.500.395
Upper Molars Left
do zębów trzonowych górnych lewych



Fig. 39R
DE.500.397
Upper Molars Right
do zębów trzonowych górnych prawych



Fig. 51S
DE.500.517
Upper Roots
do korzeni górnych

Extraction forceps set
Zestaw kleszczy ekstrakcyjnych



DE.500.001

Contents 10 pieces
Zawiera 10 sztuk

- DE.500.137 Fig. 13S
- DE.500.227 Fig. 22S
- DE.500.307 Fig. 30S
- DE.500.337 Fig. 33S
- DE.500.370 Fig. 37
- DE.500.380 Fig. 38
- DE.500.390 Fig. 39
- DE.500.395 Fig. 39L
- DE.500.397 Fig. 39R
- DE.500.517 Fig. 51S

Extraction forceps children pattern / Kleszcze ekstrakcyjne dla dzieci

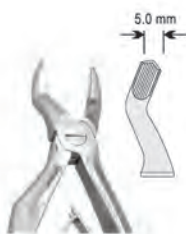

Fig. 3
DE.650.030
Upper Molars
do zębów trzonowych górnych



Fig. 5
DE.650.050
Lower Incisors
do zębów przednich dolnych



Fig. 6
DE.650.060
Lower Molars
do zębów trzonowych dolnych



Fig. 7
DE.650.070
Lower Roots
do korzeni dolnych

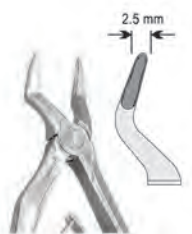

Fig. 51S
DE.650.517
Upper Roots
do korzeni górnych



Fig. 137
DE.651.370
Upper Incisors
do zębów przednich górnych



Fig. 139
DE.651.390
Upper Premolars
do zębów przedtrzonowych górnych

Extraction forceps set
Zestaw kleszczy ekstrakcyjnych



DE.650.000

Contents 7 pieces
Zawiera 7 sztuk

- DE.650.030 Fig. 3
- DE.650.050 Fig. 5
- DE.650.060 Fig. 6
- DE.650.070 Fig. 7
- DE.650.517 Fig. 51S
- DE.651.370 Fig. 137
- DE.651.390 Fig. 139

Atraumatic extraction forceps
Kleszcze ekstrakcyjne atraumatyczny

Deep and secure grip:

Fine and sharp beaks cut through periodontium to achieve contact with root structure.

Reduce fracture of crown and roots:

Anatomically shaped to perfectly match the teeth and allow to reach deep and large contact areas to provide secure grip, thus avoiding fracture to the brittle crown.

Reduce trauma to soft tissues:

The fine beaks fits in areas where standard design can not be applied, and reduces trauma to the soft tissue as they are reflected rather than crushed.



Fig. 34
DE.910.340
Upper incisors and canines, narrow beaks



Fig 34A
DE.910.341
Upper incisors and canines, wide beaks



Fig. 35
DE.910.350
Upper bicuspid, narrow beaks



Fig. 35A
DE.910.351
Upper bicuspid, wide beaks



Fig. 36
DE.910.360
Lower incisors and canines, narrow beaks



Fig. 36A
DE.910.361
Lower incisors and canines, wide beaks





Atraumatic extraction forceps
Kleszce ekstrakcyjne atraumatyczny

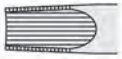

Fig. 34M
DE.910.343
Upper incisors and canines, wide beaks

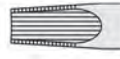

Fig. 34N
DE.910.344
Upper incisors and canines, narrow beaks

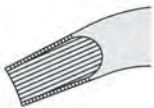

Fig. 35M
DE.910.353
Upper bicuspids, wide beaks

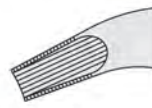

Fig. 35N
DE.910.354
Upper bicuspids, narrow beaks

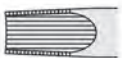
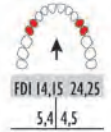

Fig. 36M
DE.910.363
Lower incisors, canines & bicuspids, wide beaks

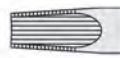

Fig. 36N
DE.910.364
Lower incisors, canines & bicuspids, narrow beaks

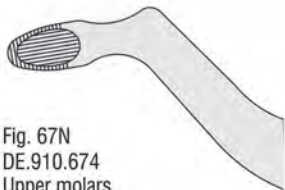

Fig. 67N
DE.910.674
Upper molars

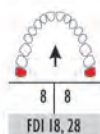

Fig. 79N
DE.910.794
Lower molars



Extraction forceps European pattern
Kleszcze ekstrakcyjne mod. Europejski (Berteny)



750 Series
Standard / Standardowe



800 Series
Finger-Form / Anatomiczne

Extraction forceps sets
Zestawy kleszczy ekstrakcyjnych

- Contents 10 pieces
Zawiera 10 sztuk
- DE.750.010 Fig. 1
 - DE.750.070 Fig. 7
 - DE.750.130 Fig. 13
 - DE.750.170 Fig. 17
 - DE.750.180 Fig. 18
 - DE.750.220 Fig. 22
 - DE.750.331 Fig. 33A
 - DE.750.511 Fig. 51A
 - DE.750.671 Fig. 67A
 - DE.750.790 Fig. 79



DE.750.000

- Contents 10 pieces
Zawiera 10 sztuk
- DE.800.010 Fig. 1
 - DE.800.070 Fig. 7
 - DE.800.130 Fig. 13
 - DE.800.170 Fig. 17
 - DE.800.180 Fig. 18
 - DE.800.220 Fig. 22
 - DE.800.331 Fig. 33A
 - DE.800.511 Fig. 51A
 - DE.800.671 Fig. 67A
 - DE.800.790 Fig. 79



DE.800.000

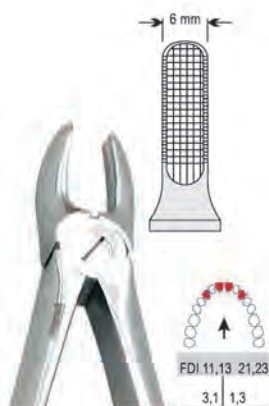

Fig. 1

Standard / Standardowe DE.750.010

Finger-Form / Anatomiczne DE.800.010

Upper Centrals and Canines/Cuspids
do zębów przednich górnych szerokie

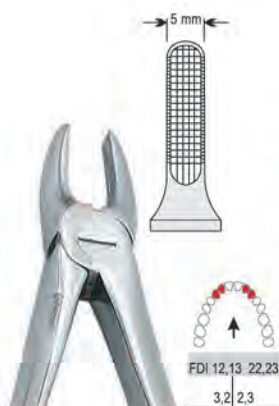

Fig. 2

Standard / Standardowe DE.750.020

Finger-Form / Anatomiczne DE.800.020

Upper Laterals and Canines/Cuspids
do zębów przednich górnych wąskie



Fig. 4

Standard / Standardowe DE.750.040

Finger-Form / Anatomiczne DE.800.040

Lower Incisors and Canines/Cuspids
do zębów przednich dolnych



Fig. 7

Standard / Standardowe DE.750.070

Finger-Form / Anatomiczne DE.800.070

Upper Premolars/Bicuspids
do zębów przedtrzonowych górnych

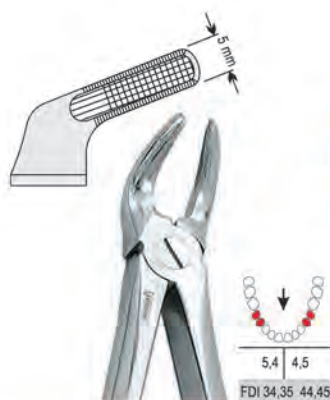

Fig. 8

Standard / Standardowe DE.750.080

Finger-Form / Anatomiczne DE.800.080

Lower Premolars/Bicuspids
do zębów przedtrzonowych dolnych



Fig. 13

Standard / Standardowe DE.750.130

Finger-Form / Anatomiczne DE.800.130

Lower Premolars/Bicuspids
do zębów przedtrzonowych dolnych

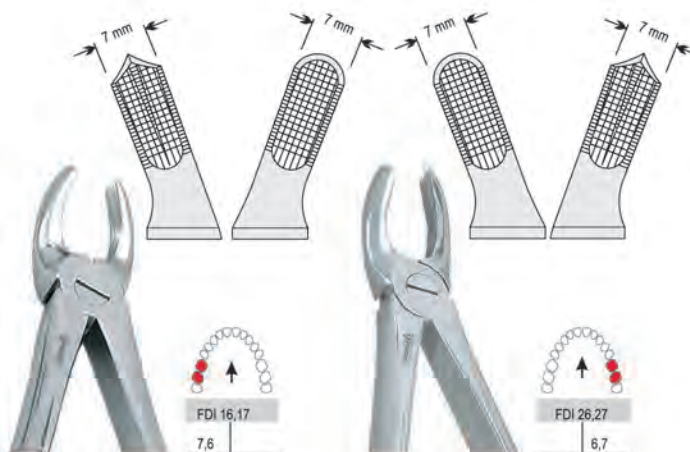

Fig. 17

Standard / Standardowe DE.750.170

Finger-Form / Anatomiczne DE.800.170

Upper Molars, Right
do zębów trzonowych górnych prawych

Fig. 18

Standard / Standardowe DE.750.180

Finger-Form / Anatomiczne DE.800.180

Upper Molars, Left
do zębów trzonowych górnych lewych

Extraction forceps European pattern / Kleszce ekstrakcyjne mod. Europejski (Berteny)

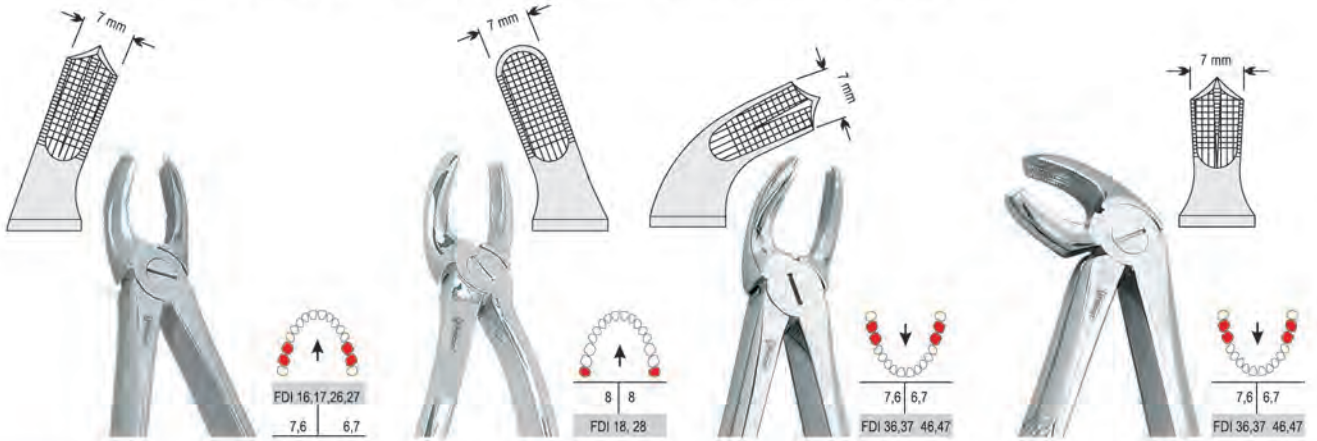

Fig. 18A

Standard / Standardowe DE.750.181

Finger-Form / Anatomiczne DE.800.181

Upper Molars
do zębów trzonowych górnych

Fig. 19

DE.750.190

DE.800.190

Upper third Molars
do zębów mądrości górnych

Fig. 21

DE.750.210

DE.800.210

Lower Molars
do zębów trzonowych dolnych

Fig. 22

DE.750.220

DE.800.220

Lower Molars
do zębów trzonowych dolnych

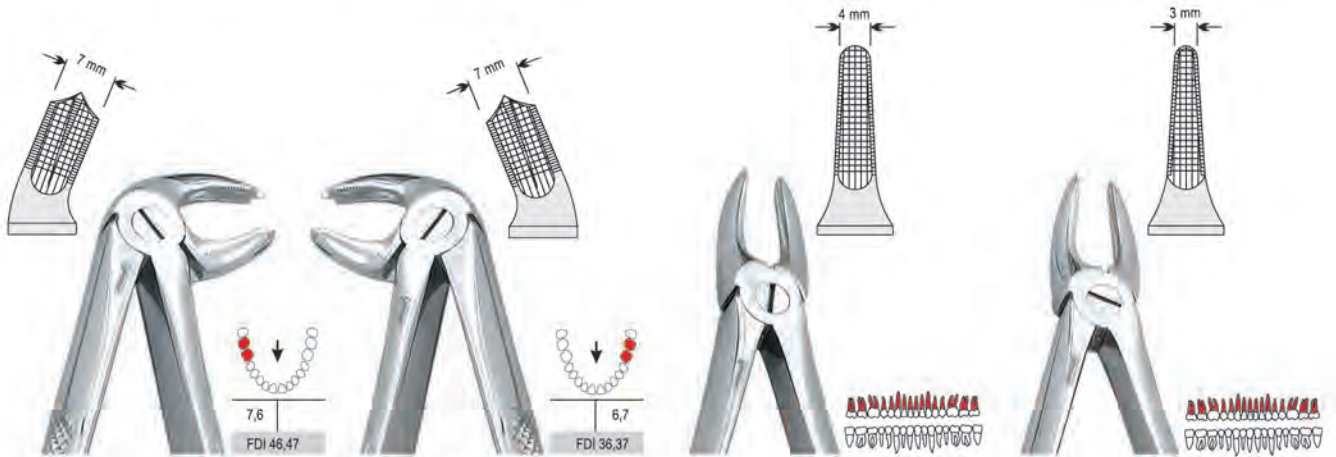

Fig. 23

Standard / Standardowe DE.750.230

Finger-Form / Anatomiczne DE.800.230

Lower Molars, Right
do zębów trzonowych dolnych prawych

Fig. 24

DE.750.240

DE.800.240

Lower Molars, Left
do zębów trzonowych dolnych lewych

Fig. 29

DE.750.290

DE.800.290

Upper roots
do korzeni górnych

Fig. 29N

DE.750.295

DE.800.295

Upper roots narrow tips
do korzeni górnych wąskie

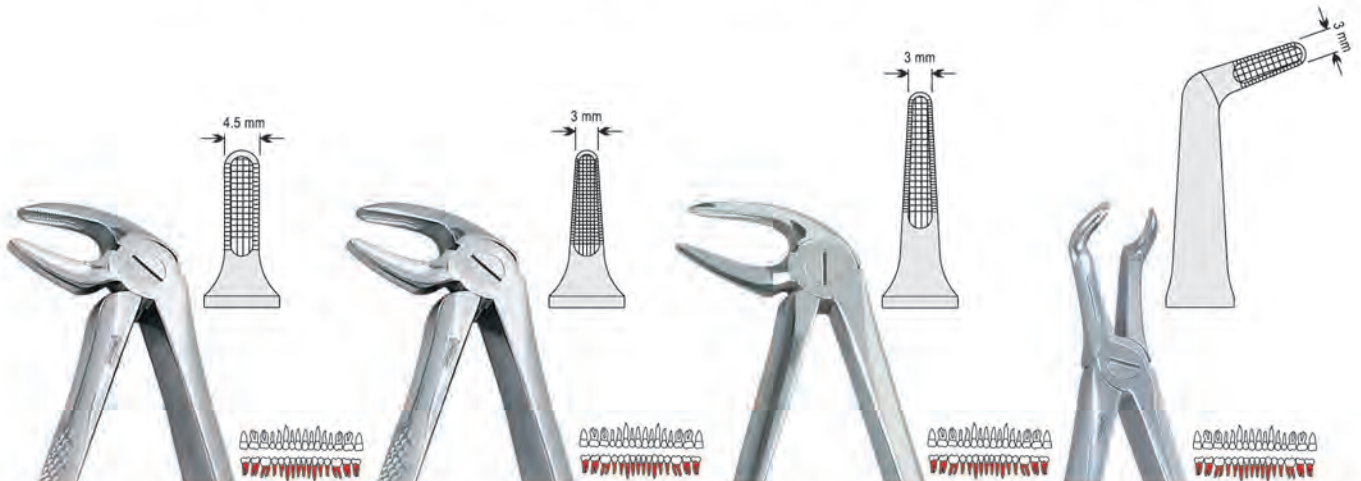

Fig. 33

Standard / Standardowe DE.750.330

Finger-Form / Anatomiczne DE.800.330

Lower roots
do korzeni dolnych

Fig. 33A

DE.750.331

DE.800.331

Lower roots narrow tips
do korzeni dolnych wąskie

Fig. 33M

DE.750.335

DE.800.335

Lower roots long tips
do korzeni dolnych długie

Fig. 45

DE.750.450

DE.800.450

Lower roots
do korzeni dolnych

Extraction forceps European pattern / Kleszcze ekstrakcyjne mod. Europejski (Berteny)



Fig. 46L

Standard / Standardowe DE.750.463

Finger-Form / Anatomiczne DE.800.463

Lower roots long tips
do korzeni dolnych długie



Fig. 51

Standard / Standardowe DE.750.510

Finger-Form / Anatomiczne DE.800.510

Upper roots
do korzeni górnych



Fig. 51A

Standard / Standardowe DE.750.511

Finger-Form / Anatomiczne DE.800.511

Upper roots narrow tips
do korzeni górnych wąskie

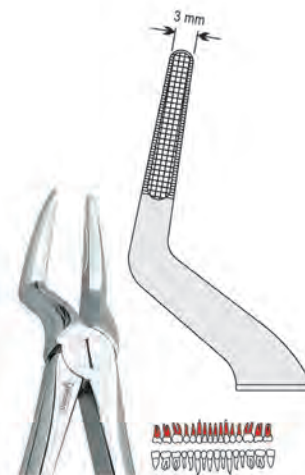

Fig. 51M

Standard / Standardowe DE.750.515

Finger-Form / Anatomiczne DE.800.515

Upper roots long tips
do korzeni górnych długie



Fig. 67

Standard / Standardowe DE.750.670

Finger-Form / Anatomiczne DE.800.670

Upper third molars
do zębów mądrości górnych

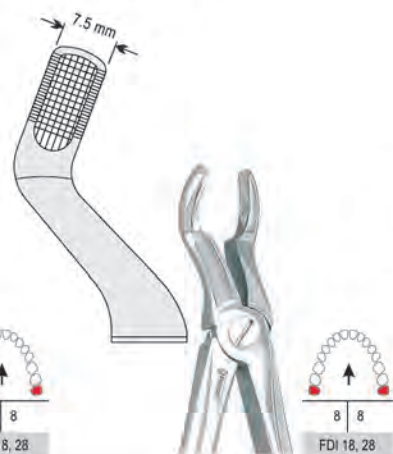

Fig. 67A

Standard / Standardowe DE.750.671

Finger-Form / Anatomiczne DE.800.671

Upper third molars
do zębów mądrości górnych



Fig. 73

Standard / Standardowe DE.750.730

Finger-Form / Anatomiczne DE.800.730

Lower molars
do zębów trzonowych dolnych



Fig. 74

Standard / Standardowe DE.750.740

Finger-Form / Anatomiczne DE.800.740

Lower roots
do korzeni dolnych



Fig. 74N

Standard / Standardowe DE.750.743

Finger-Form / Anatomiczne DE.800.743

Lower roots
do korzeni dolnych



Fig. 75

Standard / Standardowe DE.750.750

Finger-Form / Anatomiczne DE.800.750

Lower premolars/bicuspid
do zębów przedtrzonowych dolnych

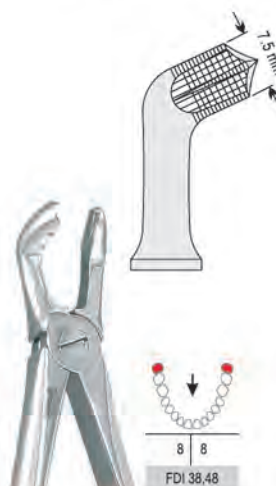

Fig. 79

Standard / Standardowe DE.750.790

Finger-Form / Anatomiczne DE.800.790

Lower third molars
do zębów mądrości dolnych



Fig. 86A

Standard / Standardowe DE.750.861

Finger-Form / Anatomiczne DE.800.861

Lower molars
do zębów trzonowych dolnych

Extraction forceps European pattern / Kleszcze ekstrakcyjne mod. Europejski (Berteny)

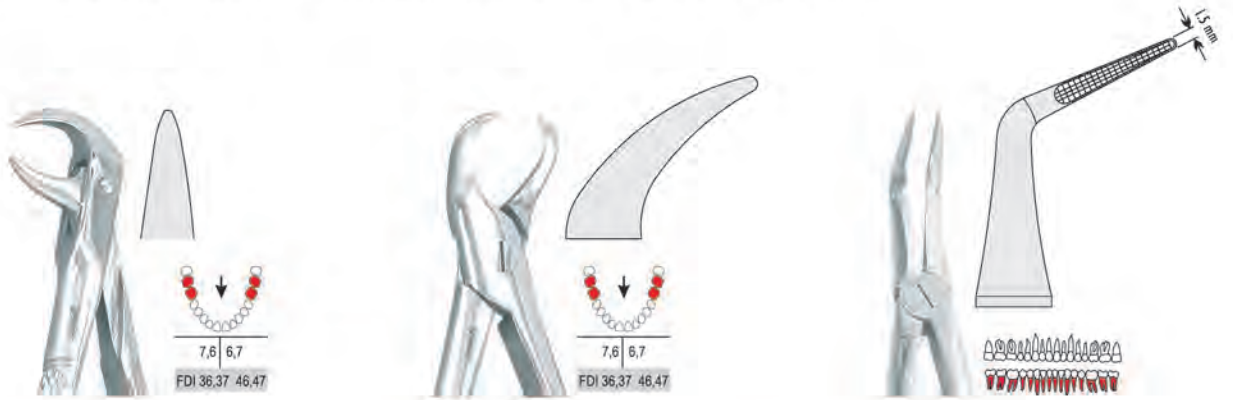

	Fig. 86C	Fig. 87	Fig. 145
Standard / Standardowe	DE.750.863	DE.750.870	DE.751.450
Finger-Form / Anatomiczne	DE.800.863	DE.800.870	DE.801.450
	Lower molars do zębów trzonowych dolnych	Lower molars do zębów trzonowych dolnych	Lower roots long tips do korzeni dolnych długie

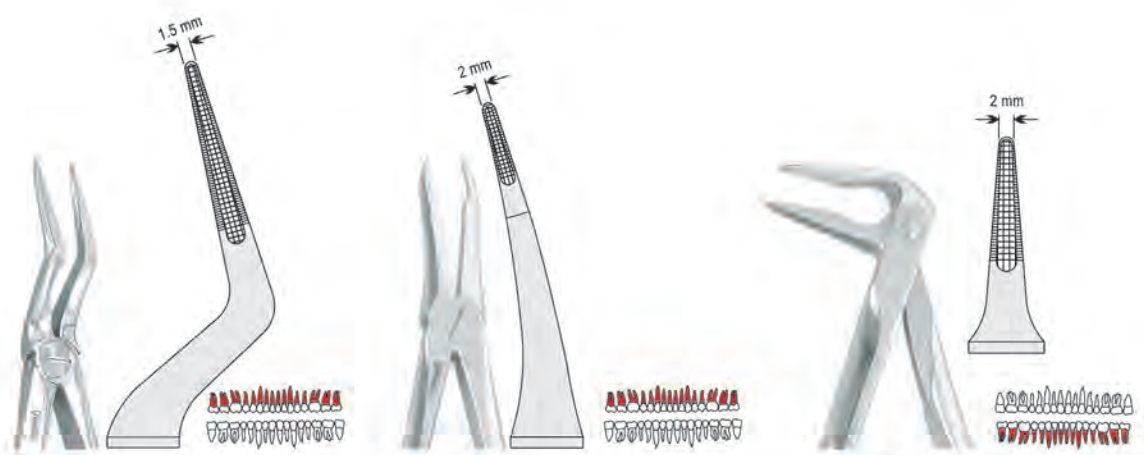

	Fig. 151 1/2	Fig. 349	Fig. 359
Standard / Standardowe	DE.751.510	DE.753.490	DE.753.590
Finger-Form / Anatomiczne	DE.801.510	DE.803.490	DE.803.590
	Upper roots long tips do korzeni górnych długie	Upper roots do korzeni górnych	Lower roots long tips do korzeni dolnych długie

Extraction forceps Meissner pattern / Kleszcze ekstrakcyjne mod. Meissner



Fig. 1
DE.875.010
Meissner

Upper and Lower Roots
do korzeni górnych i dolnych

Fig. 2
DE.875.020
Meissner

Upper and Lower Centrals, Anteriors and Bicusps
do zębów przednich i przedtrzonowych górnych oraz dolnych

Fig. 3
DE.875.030
Meissner

Upper and Lower Molars
do zębów trzonowych górnych oraz dolnych



DIAMOND GRIP



Extraction forceps
Kleszcze ekstrakcyjne

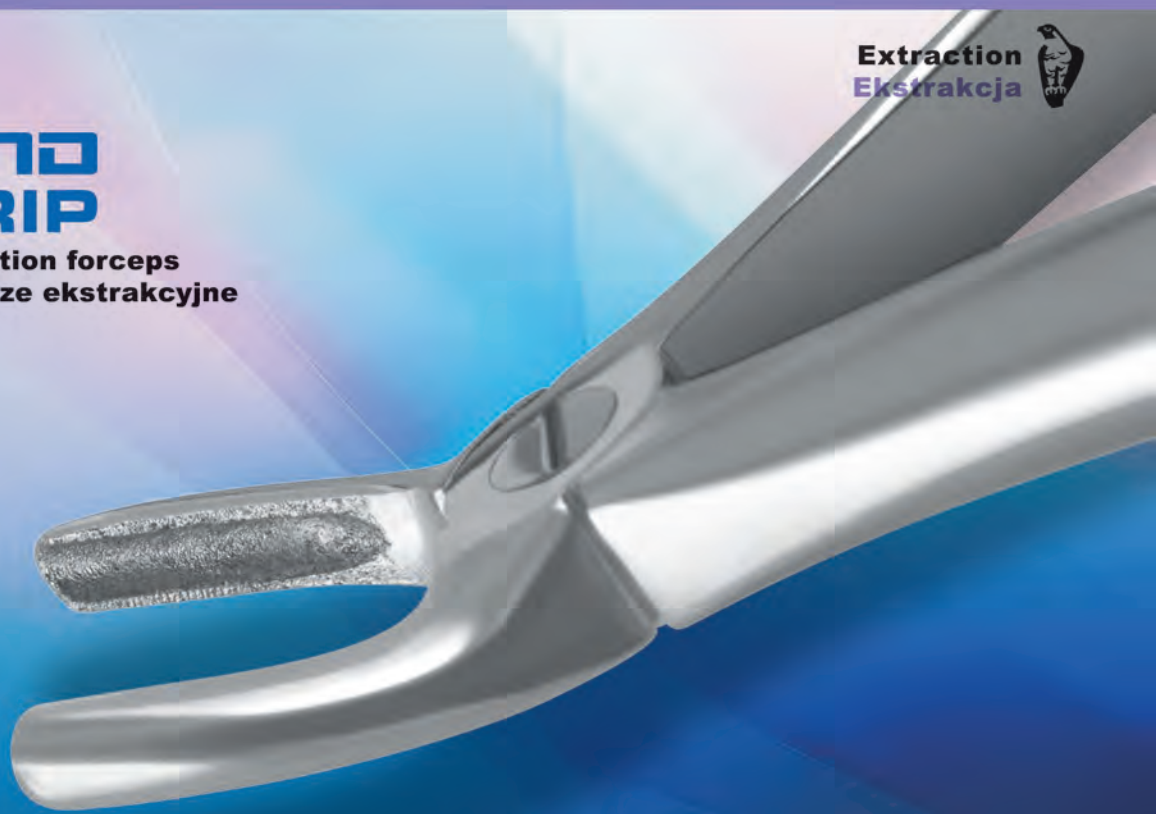

Autoclavable
Możliwość sterylizacji w autoklawie

770 SERIES



Fig. 1

DE.770.010

Upper Centrals and Canines/Cuspids
do zębów przednich górnych szerokie



FDI 11,13 21,23
3,1 | 1,3

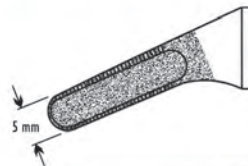

Fig. 7

DE.770.070

Upper Premolars/Bicuspids
do zębów przedtrzonowych górnych



FDI 14,15 24,25
5,4 | 4,5



Fig. 13

DE.770.130

Lower Premolars/Bicuspids
do zębów przedtrzonowych dolnych



5,4 | 4,5
FDI 34,35 44,45

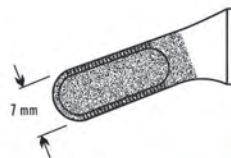

Fig. 17

DE.770.170

Upper Molars, Right
do zębów trzonowych górnych prawych



FDI 16,17
7,6



770 SERIES

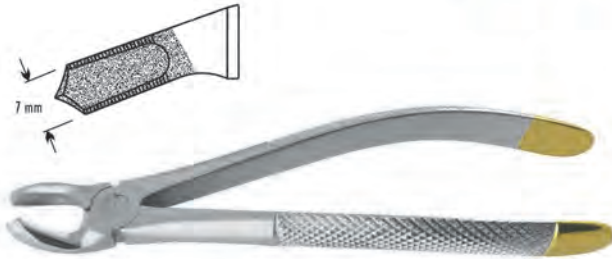

Fig. 18
DE.770.180
Upper Molars, Left
do zębów trzonowych górnych lewych

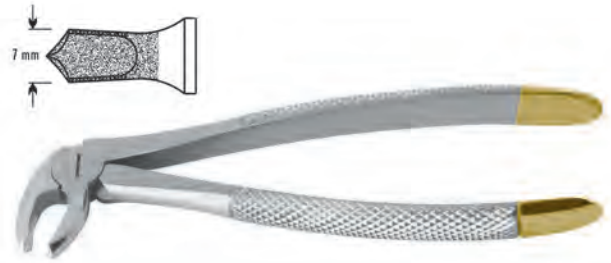
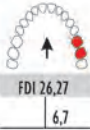

Fig. 22
DE.770.220
Lower Molars
do zębów trzonowych dolnych

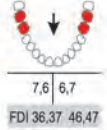

Fig. 33A
DE.770.331
Lower roots narrow tips
do korzeni dolnych wąskie



Fig. 51A
DE.770.511
Upper roots narrow tips
do korzeni górnych wąskie

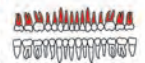

Fig. 67A
DE.770.671
Upper third molars
do zębów mądrości górnych

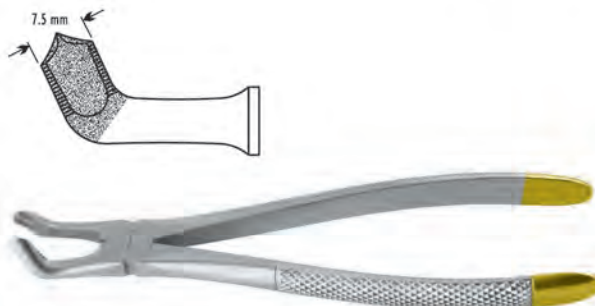
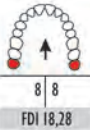

Fig. 79
DE.770.790
Lower third molars
do zębów mądrości dolnych



DE.770.000
Set of 10 pieces / Zestaw 10 szt.

- DE.770.010 Fig. 1
- DE.770.070 Fig. 7
- DE.770.130 Fig. 13
- DE.770.170 Fig. 17
- DE.770.180 Fig. 18
- DE.770.220 Fig. 22
- DE.770.331 Fig. 33A
- DE.770.511 Fig. 51A
- DE.770.671 Fig. 67A
- DE.770.790 Fig. 79



POWER - GRIP

EXTRACTION FORCEPS

KLESZCZE EKSTRAKCYJNE

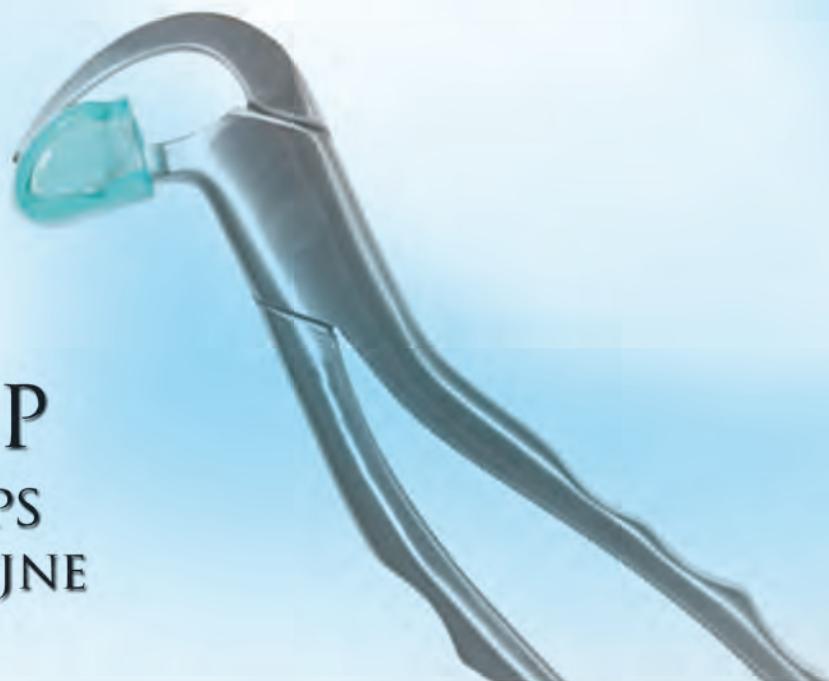

Fig. 1

DE.877.010

Upper Anteriors / Teeth #6-11



Fig. 2

DE.877.020

Upper Left / Teeth #12-15

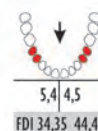

Fig. 3

DE.877.030

Upper Right / Teeth #2-5

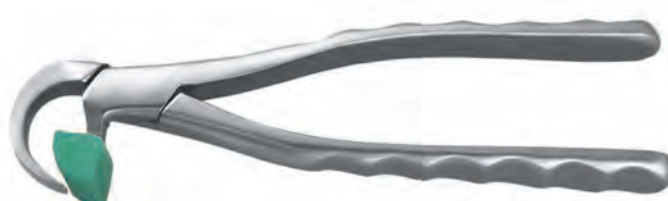
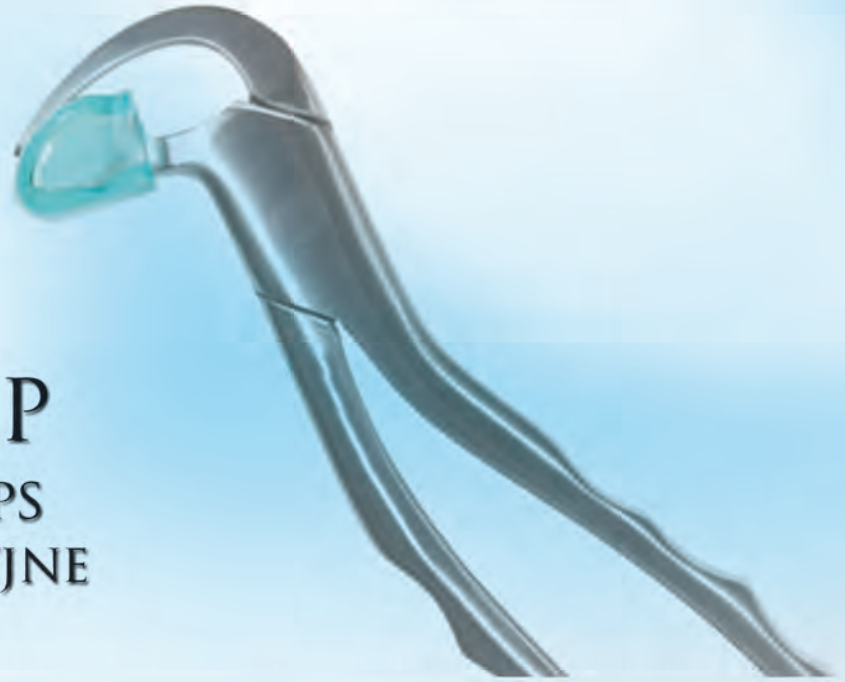

Fig. 4

DE.877.040

Lower Universal / Teeth #18-31



POWER - GRIP

EXTRACTION FORCEPS

KLESZCZE EKSTRAKCYJNE



Fig. 1
DE.878.010
Upper Anteriors / Teeth #6-11

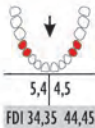

Fig. 2
DE.878.020
Upper Left / Teeth #12-15



Fig. 3
DE.878.030
Upper Right / Teeth #2-5

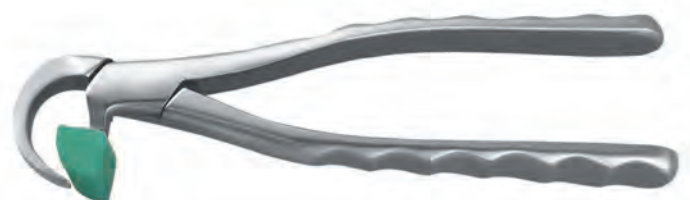

Fig. 4
DE.878.040
Lower Universal / Teeth #18-31

Spare silicone pads / Nakładki silikonowe



DE.878.100
Pack of 10 pieces / Opak. 10 szt

Extraction forceps Routurier pattern
Kleszcze ekstrakcyjne mod. Routurier



Fig. 122L
DE.881.225
Lower Molars, Left
do zębów trzonowych
dolnych lewych



Fig. 122R
DE.881.227
Lower Molars, Right
do zębów trzonowych
dolnych prawych



Extraction tweezers
Pensety ekstrakcyjne



Fig. 1
DE.975.010
Albrecht



Fig. 2
DE.975.020
Albrecht

Extraction forceps Witzel pattern
Kleszcze ekstrakcyjne mod. Witzel



Fig. 1
DE.898.010
Upper Roots
do korzeni
górných



Fig. 2
DE.898.020
Lower Roots
do korzeni
dolnych



Extraction forceps
Kleszcze ekstrakcyjne



Fig. 1
DE.900.010

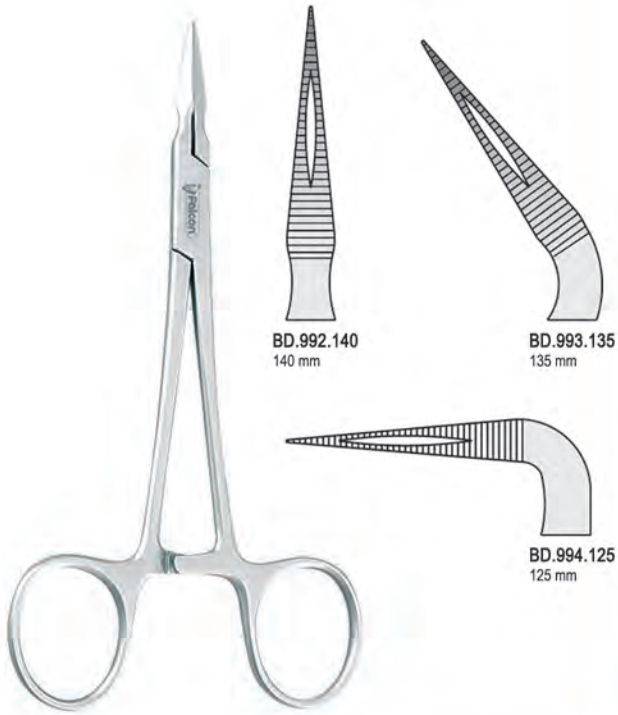

Fig. 2
DE.900.020





Stieglitz splinter forceps
Kleszczyki Stieglitz do usuwania odłamków korzeni



Air syringe
Strzykawka powietrzna



DE.952.000

Water syringe
Strzykawka wodna



DE.965.000

Elevators root tips
Dźwignie do korzeni



DE.275.360
Heidebrink delicate
Fig 36



DE.275.370
Heidebrink medium
Fig 37



DE.275.380
Heidebrink heavy
Fig 38

D₁₁

Surgery & Implantology / Chirurgia i implantologia

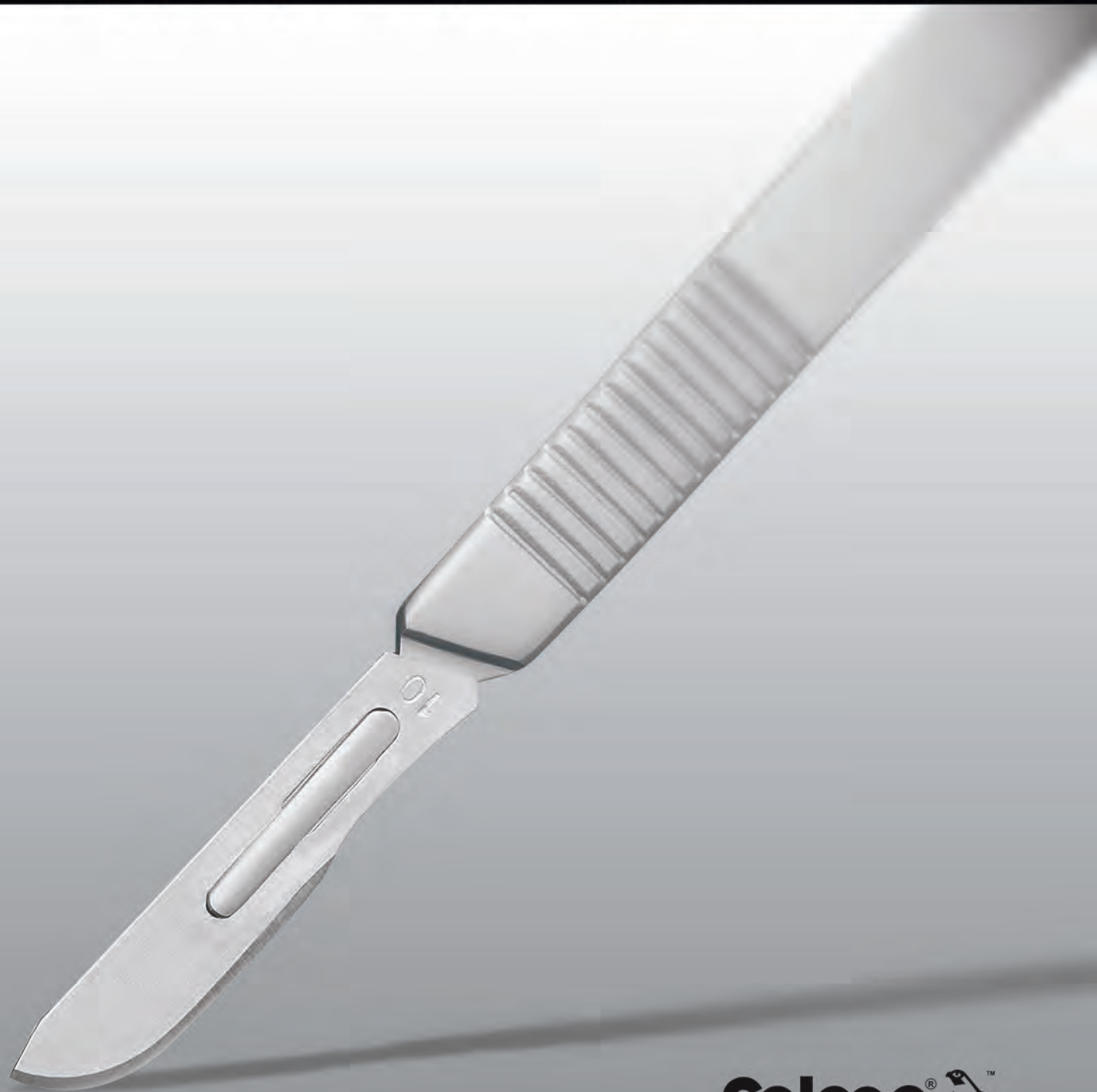

Micro surgery instruments / Instrumenty mikrochirurgiczne

Micro scalpel blade handles
Uchwyty do skalpeli mikro



Safety Model
BM.042.100 100 mm
BM.042.130 130 mm
BM.042.150 150 mm
BM.047.130 130 mm
BM.044.100 100 mm

Micro scalpel blades
Ostrza do skalpeli mikro

Surgistar™
The Cutting Edge of Tomorrow

Pack of 6 pieces / Opak. 6 sztuk.

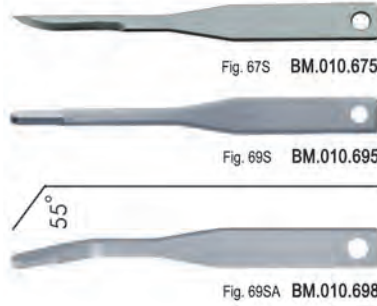

Fig. 67S BM.010.675

Fig. 69S BM.010.695

Fig. 69SA BM.010.698



STERILE R ②

Swann-Morton®

Each / Sztuka



SM61
Fig. 61 BM.010.610

SM62
Fig. 62 BM.010.620

SM63
Fig. 63 BM.010.630

SM64
Fig. 64 BM.010.640

SM65
Fig. 65 BM.010.650

SM67
Fig. 67A BM.010.670

SM69
Fig. 69 BM.010.690

SP90
Fig. 90 BM.010.900

SP91
Fig. 91 BM.010.910

Micro forceps titanium
Pensety mikro tytanowe

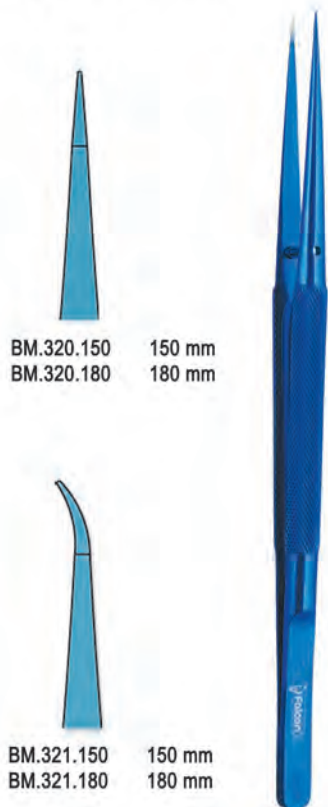

BM.320.150 150 mm
BM.320.180 180 mm

BM.321.150 150 mm
BM.321.180 180 mm

Micro tissue forceps titanium
Pensety mikro chirurgiczne tytanowe



1x2th / 1x2 zębki

BM.370.150 150 mm
BM.370.180 180 mm

1x2th / 1x2 zębki

BM.371.150 150 mm
BM.371.180 180 mm

Titanium
Tytanowe

Diamond Coated
Pokryte diamentem



Micro surgery instruments / Instrumenty mikrochirurgiczne

Micro forceps
Pensety mikro

Stainless steel
Ze stali nierdzewnej

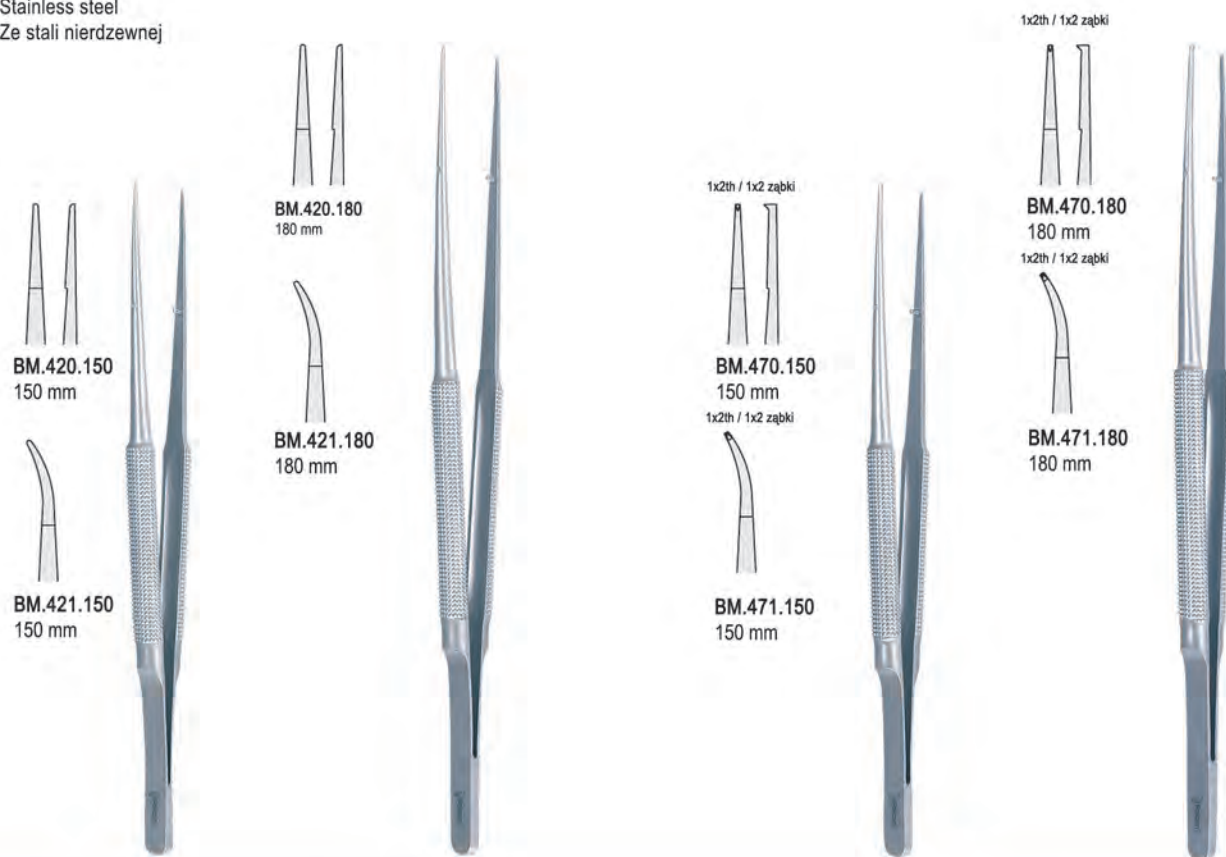

Titanium micro needle holders
Igotrzymacze mikro tytanowe

Needle holders with scissors
Igotrzymacze mikro z nożyczkami

Titanium
Titanio
Tytanowe

Diamond Coated
Pokryte diamentem

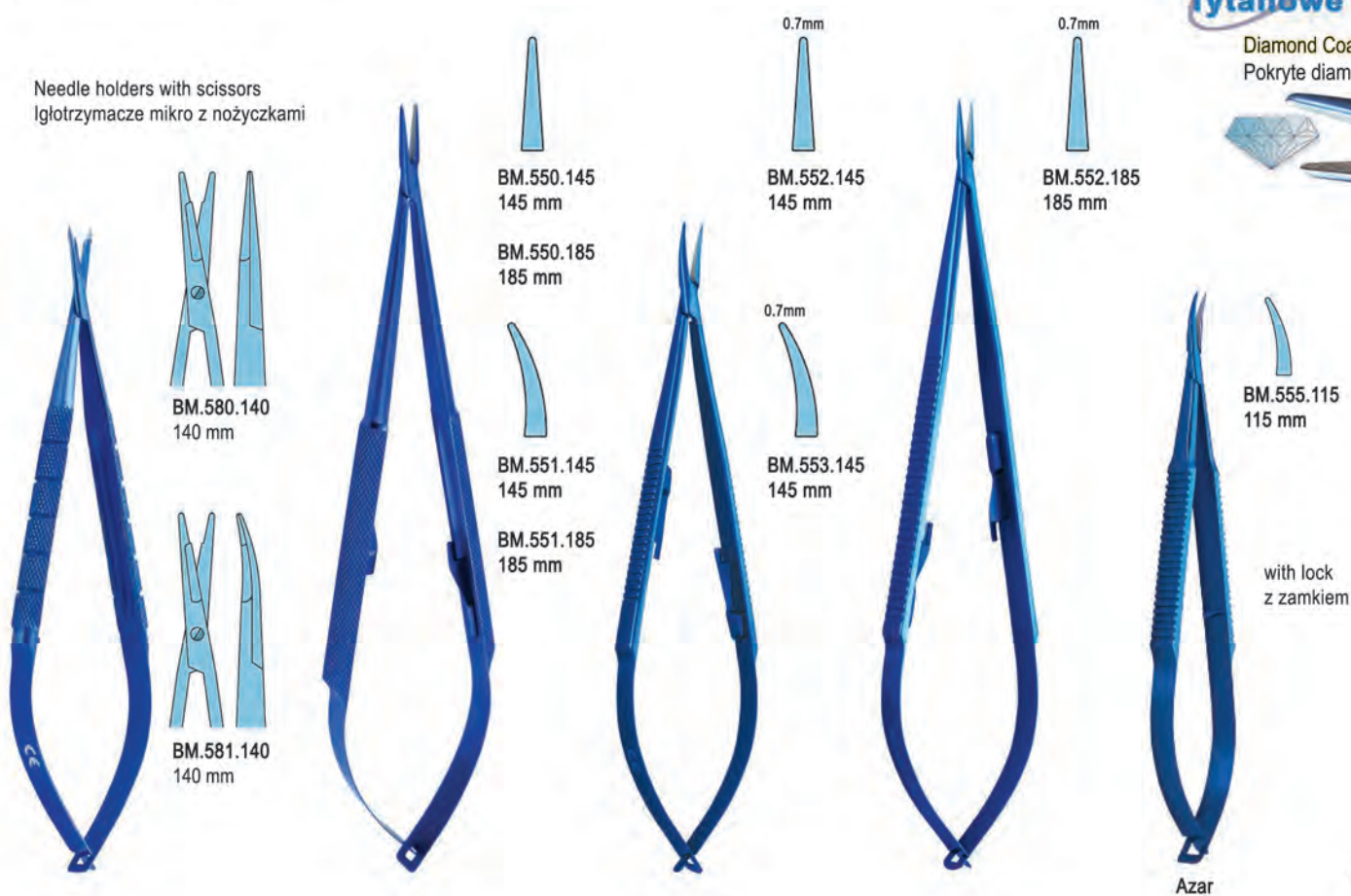

Micro needle holders
Igłotrzymacze mikro

Falcon
GRIP With Tungsten Carbide Inserts
z wkładką z węgla spiekanego

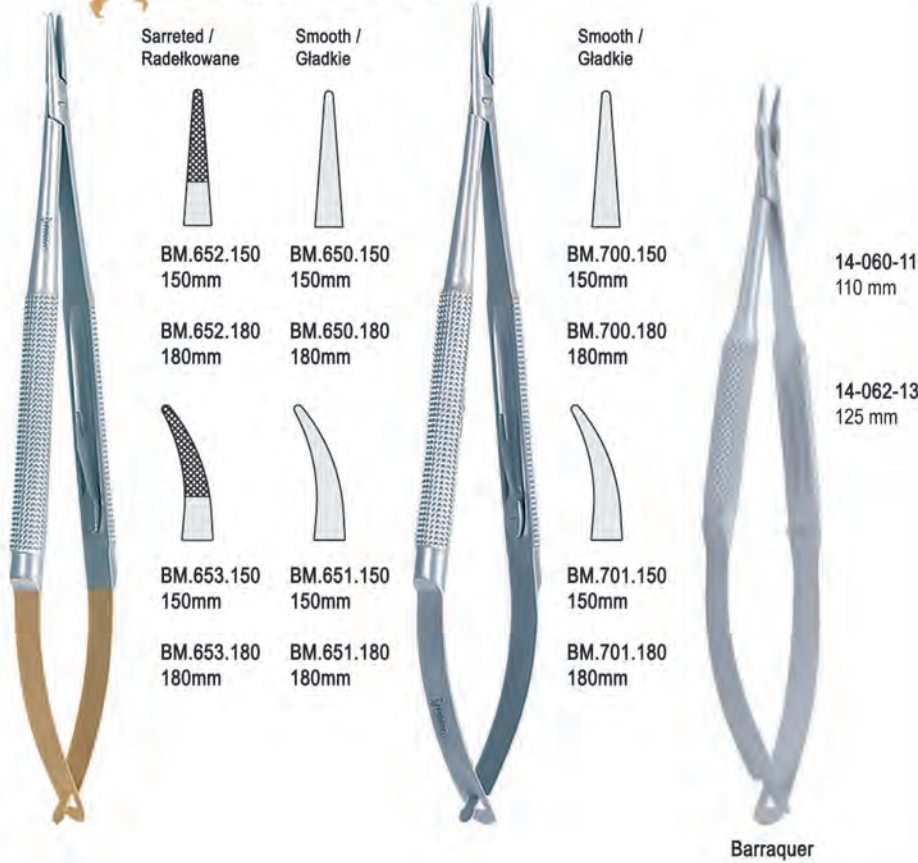

Titanium micro scissors
Nożyczki mikro tytanowe

with stainless steel blades
z ostrzami ze stali nierdzewnej

Titanium
Tytanowe

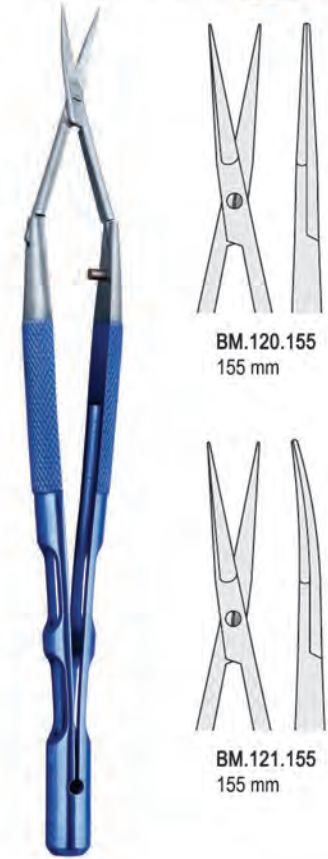

with stainless steel blades
z ostrzami ze stali nierdzewnej

Titanium
Tytanowe

Micro scissors for ligature,
one blade serrated
Nożyczki mikro do nici, jedno
ostrze ząbkowane

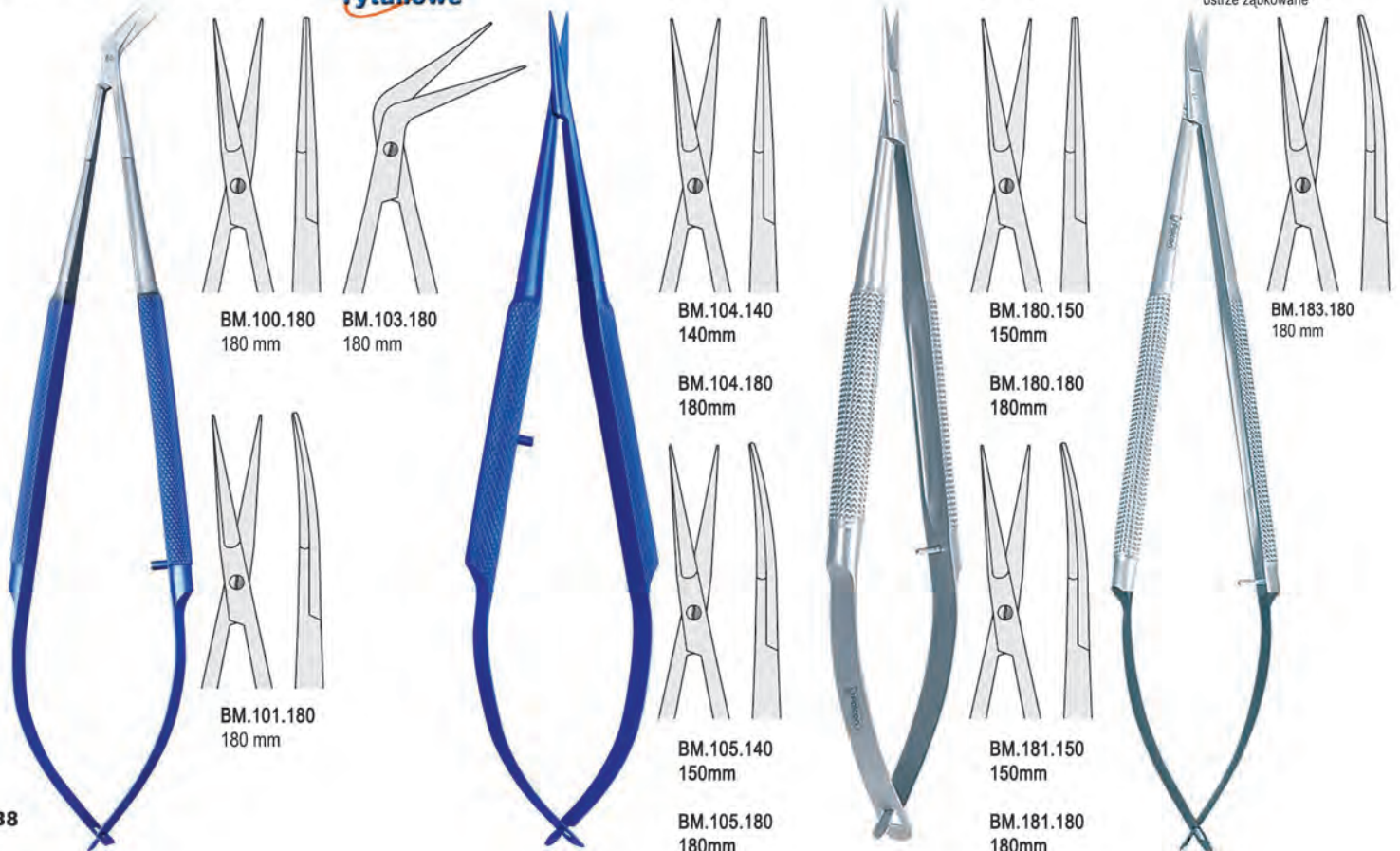

Retractors / Rozwieraki

Implantology instruments / Instrumenty implantologiczne

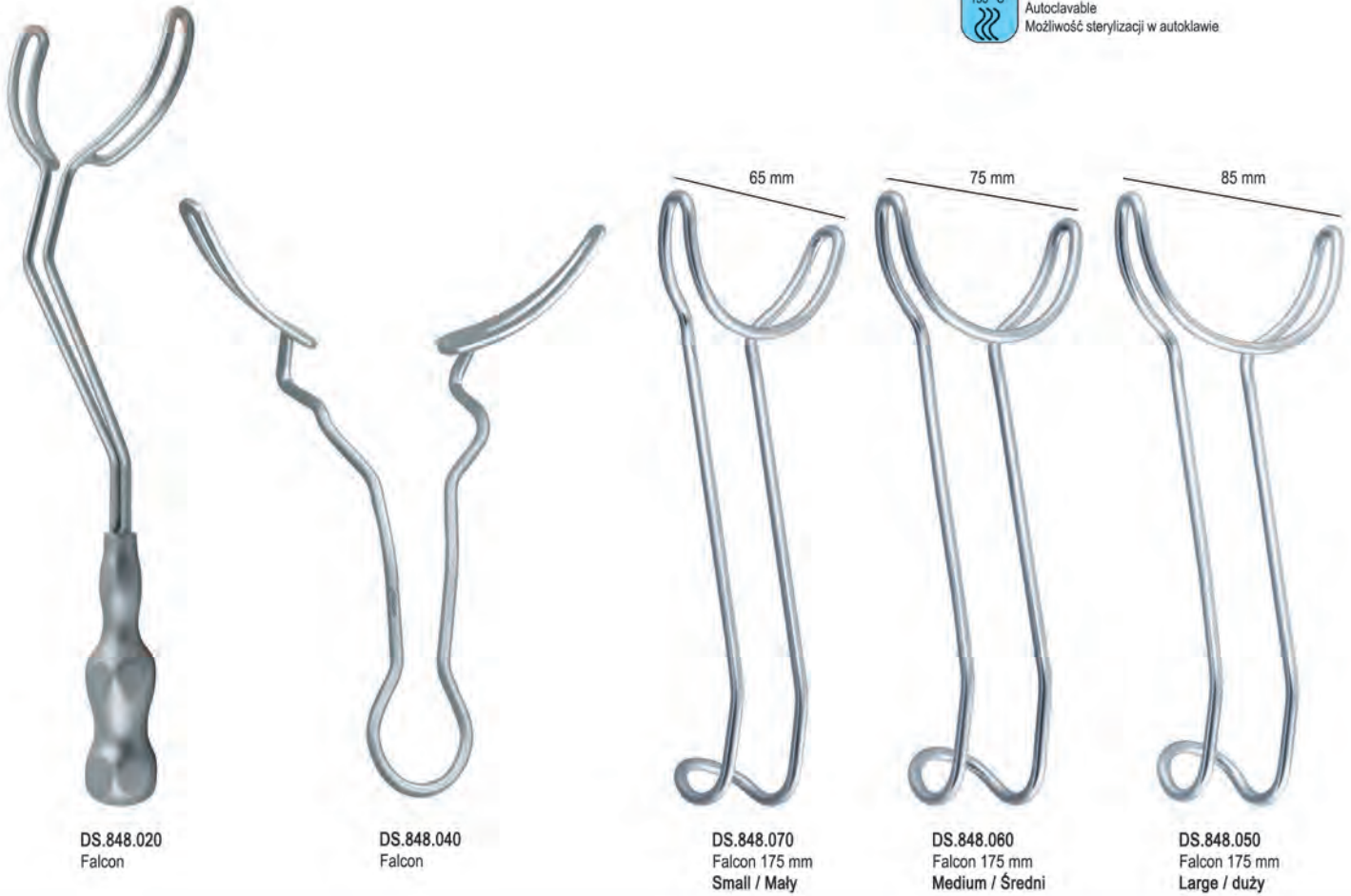
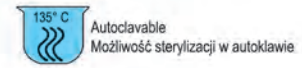

**Depth measuring probes
Sondy do mierzenia głębokości**

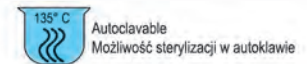

**Ratchet screw driver handles
Klucze zapadkowe**

- Hexagonal head
- Clockwise for tightening
- Anti-clockwise for removing
- Without torque

Sześciokątna główka
Wprowadzanie zgodnie z ruchem wskazówek zegara
Wijmowanie przeciwnie do ruchu wskazówek zegara
Bez torku

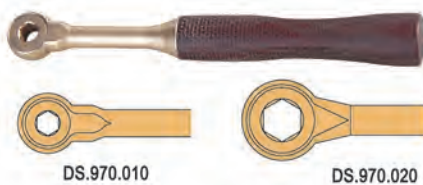

Trephines RA / Wiertła trepanowe na kątnicę

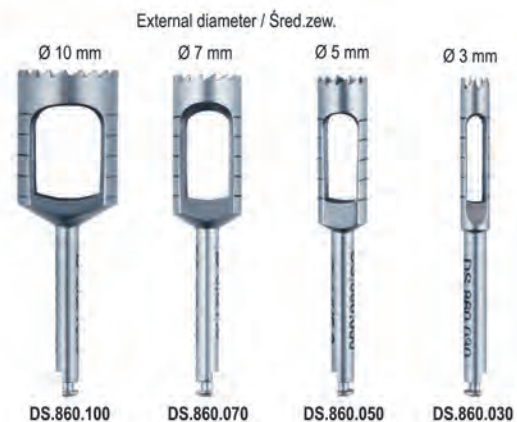

Bone thickness gauges
Miarki implantologiczne



DS.805.000
Falcon



DS.803.010
Falcon



Fig. 1
DS.804.010
Castroviejo



Fig. 2
DS.804.020
Castroviejo



Fig. 3
DS.804.030
Castroviejo



Fig. 4
DS.804.040
Castroviejo



Fig. 5
DS.804.050
Castroviejo

Bone thickness gauges
Miarki implantologiczne



DS.804.060
105mm straight / prosta

DS.804.070
105mm angled / wygięta

Sinus rongeur
Odgryzacz kostny do zatok

Delicate bone cutting forceps for opening the sinus window 4mm bite, TIN coated
Delikatne kleszce kostne do otwierania "okna zatoki", pokryte azotkiem tytanu, wycinek 4 mm



DS.929.010
Falcon

Bone expander kit
Zestaw do śrubowego rozszerzania kości



- DS.990.000
- 5 x Bone expansion screws (2.6mm, 3.0mm, 3.4mm, 3.8mm, 4.3mm)
 - 1 x Ratchet wrench, 4.0mm square
 - 1 x 4.0mm Motor mount adapter
 - 1 x Ratchet extender
 - 1 x Hand driver
 - 1 x 1.8mm Drill
 - 2 x Pins
 - 1 x Sterilization cassette box

Century-line 1908 - 2008

Osteotomes / Osteotomy

TIN coated and laser marked / Pokryte azotkiem tytanu, znakowanie laserowe

 Autoclavable
Możliwość sterylizacji w autoklawie



DS.812.060
6.0 mm
Light Blue

Step osteotome
for secure splitting in steps

Osteotom stopniowy rozszczepia
kości oraz równocześnie stopniowo
je rozszerza

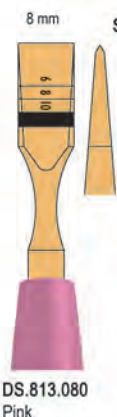

Straight / Prosty

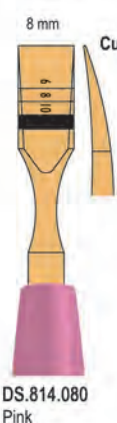
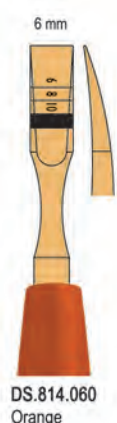
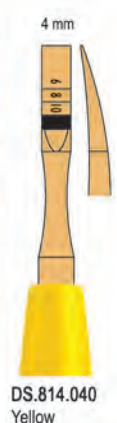

Curved / Zagięty

Bone tampers
Osteotomy atraumatyczne



4 mm
DS.928.040
Grey
7 mm
DS.928.070
Turquoise

For separating sinus window
from surrounding bone

Do odseparowania "okna zatoki"
od otaczającej kości

Osteotomes / Osteotomy

Laser marked / Znakowanie laserowe



Color coded / Uchwyt znaczony kolorem



DS.813.000
Set of 8 pieces / Zestaw 8 sztuk

Straight / Prosty



Curved / Zagięty

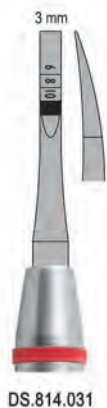

Osteotomes / Osteotomy

 Autoclavable
Możliwość sterylizacji w autoklawie



Mallets / Młotki

 Autoclavable
Możliwość sterylizacji w autoklawie



TIN coated bone block clamps

To hold and stabilize block graft against recipient site while placing screws. Slotted tips act as a guide for precise drilling.

Kleszcze do bloczków kostnych pokryte azotkiem tytanu

Trzymają i stabilizują przeszczep kostny w miejscu biorczym podczas umieszczania śrub. Rowki na końcówkach kleszczy umożliwiają precyzyjne nawiercanie.



Bone injectors
Iniektory do kości



Century-line 1908 - 2008

TIN coated bone grafting instruments / Instrumenty do przeszczepu kostnego pokryte azotkiem tytanu

Titanium Nitride is hypoallergenic. As such it is an ideal material for coating instruments destined for implantology on account of a number of benefits:

- 100% safe when used for bone splitting, punching and grafting.
- highly polished, mirror finish surfaces so that less force is required during bone condensing, punching and splitting
- totally non stick so that no material is left to adhere to the surface of the instrument and placement of bone graft is quicker
- the extremely smooth surfaces of TIN coating allows for easier cleaning/decontamination

Azotek tytanu jest hypoalergiczny. Jako doskonały materiał do powlekania instrumentów do implantologii posiada następujące cechy:

- 100 % bezpieczny podczas rozszczepiania, przebijania i rozdzielania kości
- idealnie wypolerowana powierzchnia instrumentu pozwala na użycie mniejszej siły podczas kondensacji lub rozszczepiania kości
- całkowicie "nieprzyklejający", dzięki czemu żaden materiał nie przylega do powierzchni instrumentu
- bardzo gładka powierzchnia instrumentu pokrytego azotkiem tytanu umożliwia jego łatwe czyszczenie i odkażanie

Bone mill

- Designed by Giuliano Lorenzetti, President of Falcon Medical Italia Srl.
- Simple and practical design
- Supplied with three interchangeable Titanium crushing heads of which two (fine and coarse serrations) for manual grinding and one for hammer percussion.
- Titanium bone container
- Registered Design

Młynek do mielenia kości

- Zaprojektowany przez Giuliano Lorenzetti, prezesa firmy Falcon Medical Italia Srl
- Prosty i praktyczny model
- Posiada trzy wymienne tytanowe główki do rozdrabniania kości (dwie z chropowatą powierzchnią - drobniejszą i grubszą) do ręcznego mielenia i jedną gładką do miażdżenia przy użyciu młotka
- Tytanowy pojemnik na kości
- Zarejestrowany model

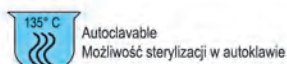

DS.850.000



Bone well / Miseczka na kości



DS.853.010

Bone mill

Młynek do rozdrabniania kości

Titanium
Tytanowe

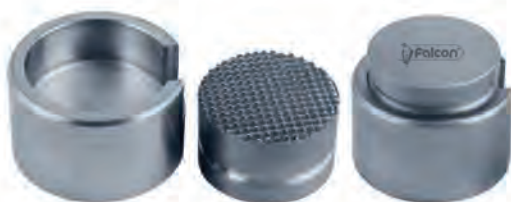

DS.851.040

Titanium / Tytanowe



DS.851.060

Stainless steel / Stal nierdzewna

Bone morselizer forceps

Kleszcze z młynkiem do rozdrabniania kości



DS.851.010

Bone collector

Przyrząd do zbierania odłamków kostnych



DS.854.000



DS.854.010

Disposable stainless steel cartridge
Jednorazowy pojemnik ze stali
nierdzewnej

Pack of 10 pieces / Opak. 10 szt.

Bone scrapers / Skrobaczki kostne

For formation, collection and delivery of ready-to-use osseous coagulum
Do formowania, pobierania i zbierania gotowego koagulatu kostnego



DS.849.010

Stainless steel bone scraper straight, complete with one blade
Skrobaczka kostna prosta ze stali nierdzewnej z jednym ostrzem

DS.849.011

Titanium bone scraper straight, complete with one blade
Skrobaczka kostna prosta tytanowa z jednym ostrzem



DS.849.020

Stainless steel bone scraper angled, complete with one blade
Skrobaczka kostna zagięta ze stali nierdzewnej z jednym ostrzem

DS.849.021

Titanium bone scraper angled, complete with one blade
Skrobaczka kostna zagięta tytanowa z jednym ostrzem



DS.849.030

Stainless steel universal blade for straight or curved bone scraper
Uniwersalne ostrze wymienne ze stali nierdzewnej do skrobaczki kostnej prostej lub zagiętej

DS.849.031

Titanium universal blade for straight or curved bone scraper
Uniwersalne ostrze wymienne tytanowe do skrobaczki kostnej prostej lub zagiętej

Implant scaling instruments / Instrumenty do skalingu implantów

Easy
COLOR Titanium
Tytanowe



DS.801.011
WHO

Fig. 4L/4R
DS.801.201
Columbia

Fig. 204S
DS.801.601

Fig. 6/7
DS.801.701
Hygienist



DS.801.999

Implant scaling instrument kit
4 pieces, one of each type and tray
Zestaw 4 instrumentów do skalingu
implantów z tacką

Applicators for bone grafting materials, TIN coated / Aplikatory materialu kostnego, Pokryte azotkiem tytanu

CLASSIC-LITE 10 mm hollow handle
10 mm pusty uchwyt



DS.863.045T Applicator / Aplikator



DS.863.015T Applicator / Aplikator



DS.864.015T Applicator and compactor / Aplikator i upychadlo

Membrane placement instruments / Instrumenty do umieszczania błony



DS.867.015T



DS.867.025T



DS.868.010 110 mm

**Falcon P.R.F. membrane box TIN coated
Pudełko Falcon do membrany P.R.F. pokryta azotkiem tytanu**



DS.869.001T

**Falcon P.R.F. membrane tray, TIN coated
Tacka Falcon do membrany P.R.F. pokryta azotkiem tytanu**



DS.869.003T
100 x 60 x 5 mm

**Membrane bowl, TIN coated
Miseczka do membrany, pokryta azotkiem tytanu**



DS.869.002T



CLASSIC-LITE

10 mm hollow handle
10 mm pusty uchwyt

Compactors / Upychadła



DS.865.015



DS.865.025

TIN coated / Pokryte azotkiem tytanu



DS.865.015T



DS.865.025T

Periotome / Periotom



CLASSIC-LITE

10 mm hollow handle
10 mm pusty uchwyt

TIN coated / Pokryte azotkiem tytanu



Fig. 1 DS.846.015T



Fig. 2 DS.846.025T

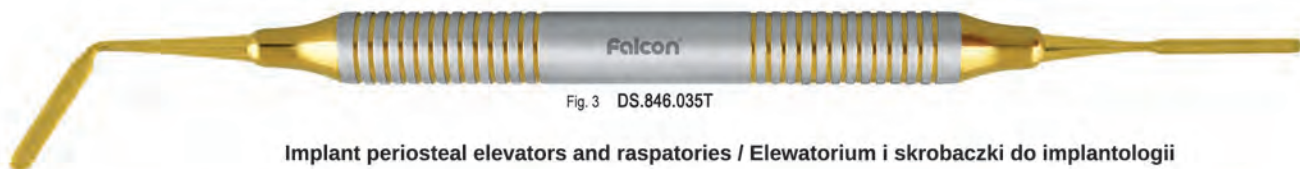

Fig. 3 DS.846.035T

Implant periosteal elevators and raspatories / Elewatorium i skrobaczki do implantologii



Fig. 1 DS.845.015T



Fig. 2 DS.845.025T
Sharp-Blunt / Ostro-tępa



Fig. 1 DS.838.015T
Atraumatic papilla elevator / Elewatorium atraumatyczne do brodawek

Ergo-form Osteotomes

Condensing osteotomes with stop concave / Kondensatory z ogranicznikiem

Tapered convex tips

Stożkowe końcówki, wypukłe na "czubku"

In case of soft bone structure, bone condensers are used for lateral condensation to achieve bone stability in closed sinus elevation technique. Convex tips minimize the risk of perforation when lifting the Schneider's membrane

W przypadku miękkich struktur kości używa się różnych upychadeł do stopniowego ubijania aż zostanie osiągnięta początkowa stabilność kości (w metodzie zamkniętej podnoszenia zatoki). Wypukłe końcówki minimalizują ryzyko przebicia podczas podnoszenia błony Schneidera.



DS.931.122	DS.931.128	DS.931.135	DS.931.142	DS.931.148	DS.936.122	DS.936.128	DS.936.135	DS.936.142	DS.936.148
1.5-2.2 mm	2.2-2.8 mm	2.8-3.5 mm	3.5-4.2 mm	4.2-4.8 mm	1.5-2.2 mm	2.2-2.8 mm	2.8-3.5 mm	3.5-4.2 mm	4.2-4.8 mm
Red	Green	Blue	Purple	Black	Red	Green	Blue	Purple	Black
Czerwony	Zielony	Niebieski	Purpurowy	Czarny	Czerwony	Zielony	Niebieski	Purpurowy	Czarny

Ergo-Form condensing osteotome with stops set / Zestaw kondensatorów Ergo-Form z ogranicznikiem



DS.931.100
Set of 10 pieces / Zestaw 10 sztuk



Bone condensing osteotomes, tapered convex tips
Upychadła do kości (kondensatory), stożkowe końcówki, wypukłe na "czubku"

In case of soft bone structure, bone condensers are used for lateral condensation to achieve bone stability in closed sinus elevation technique. Convex tips minimize the risk of perforation when lifting the Schneider's membrane

W przypadku miękkich struktur kości używa się różnych upychadeł do stopniowego ubijania aż zostanie osiągnięta początkowa stabilność kości (w metodzie zamkniętej podnoszenia zatoki). Wypukłe końcówki minimalizują ryzyko przebicia podczas podnoszenia błony Schneidera.

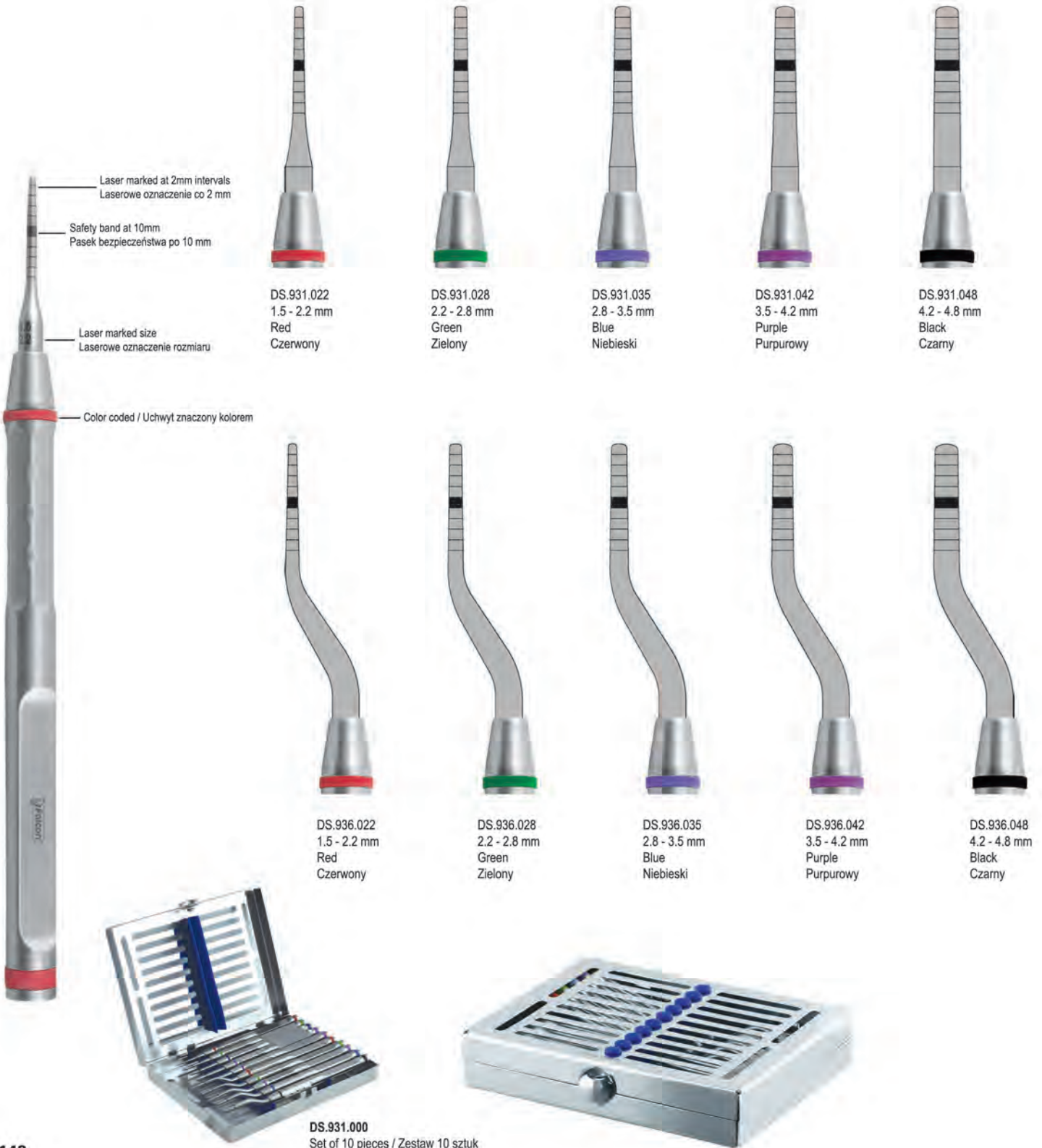

Bone condensing osteotomes Upychadła do kości (kondensatory)

Tapered convex tips Stożkowe końcówki, wypukłe na "czubku"

In case of soft bone structure, bone condensers are used for lateral condensation to achieve bone stability in closed sinus elevation technique. Convex tips minimize the risk of perforation when lifting the Schneider's membrane

W przypadku miękkich struktur kości używa się różnych upychadeł do stopniowego ubijania aż zostanie osiągnięta początkowa stabilność kości (w metodzie zamkniętej podnoszenia zatoki). Wypukłe końcówki minimalizują ryzyko przebicia podczas podnoszenia błony Schneidera.



Century-line 1908 - 2008 TIN coated / Pokryte azotkiem tytanu

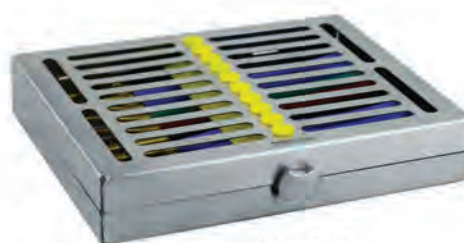

DS.930.000
Set of 10 pieces / Zestaw 10 sztuk

Ergo-form Osteotomes

Sinus osteotomes with stop convex / Sinusotomy z ogranicznikiem

Straight concave tips

Proste końcówki, wklęsłe na "czubku"

Used for closed sinus elevation technique, concave semi-sharp tips lift sinus floor and additional bone towards cranial to achieve stable foundation for the placement of implants.

Stosowane w metodzie zamkniętej podnoszenia dna zatoki szczękowej w kierunku czaszki. Wklęsłe końcówki, półostre na obrzeżu umożliwiają dodatkowo zbieranie kości do dalszego podnoszenia, co pozwala uzyskać stabilne oparcie do umieszczenia implantu.

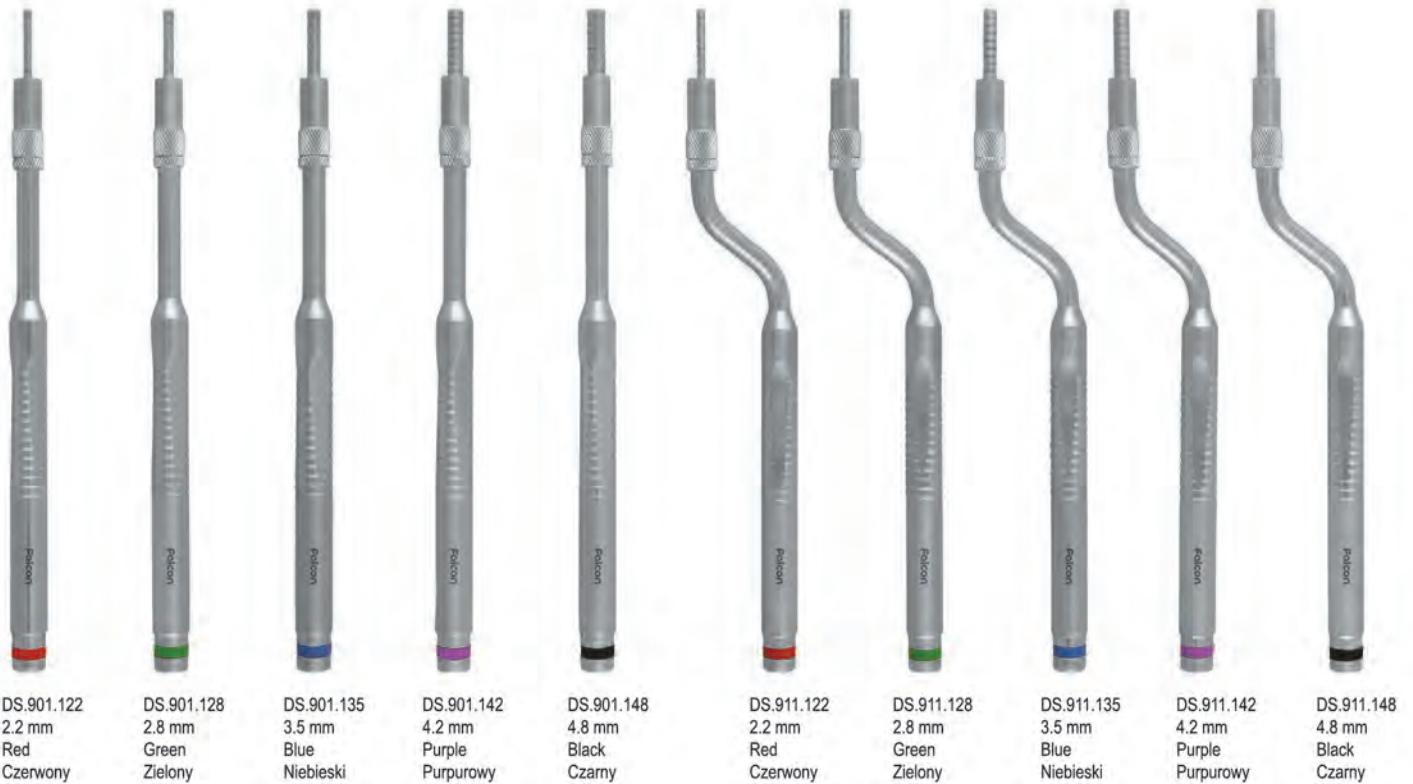

Ergo-Form Sinus osteotome concave set / Ergo-Form Zestaw sinotomów z ogranicznikiem



DS.901.100
Set of 10 pieces / Zestaw 10 sztuk

Sinus lift osteotomes, straight concave tips
Sinotomy, proste końcówki, wklęsłe na "czubku"

Used for closed sinus elevation technique, concave semi-sharp tips lift sinus floor and additional bone towards cranial to achieve stable foundation for the placement of implants.

Stosowane w metodzie zamkniętej podnoszenia dna zatoki szczękowej w kierunku czaszki. Wklęsłe końcówki, półostre na obrzeżu umożliwiają dodatkowo zbieranie kości do dalszego podnoszenia, co pozwala uzyskać stabilne oparcie do umieszczenia implantu.

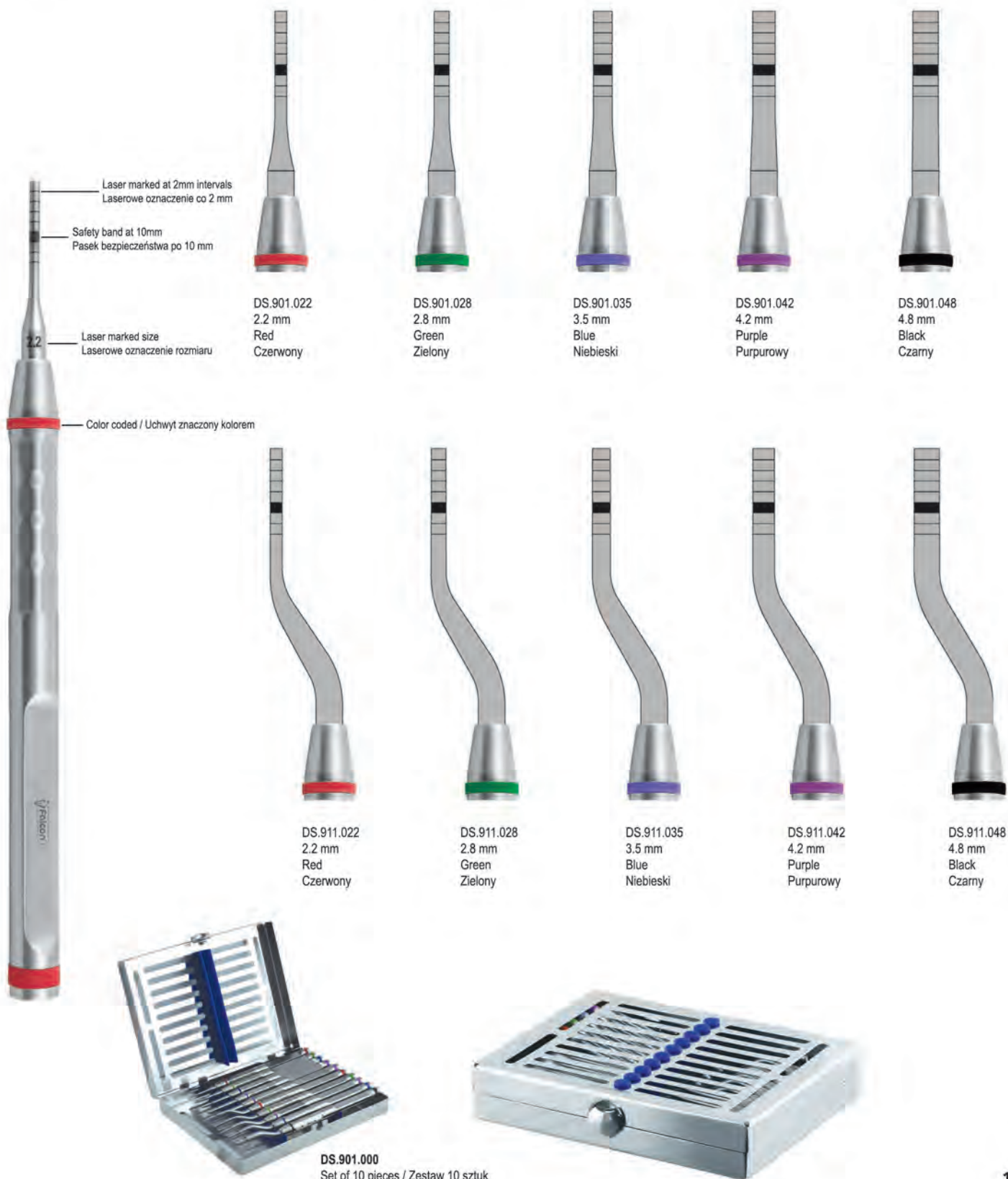



Sinus lift osteotomes Sinotomy

Straight concave tips Proste końcówki, wklęsłe na "czubku"

Used for closed sinus elevation technique, concave semi-sharp tips lift sinus floor and additional bone towards cranial to achieve stable foundation for the placement of implants.

Stosowane w metodzie zamkniętej podnoszenia dna zatoki szczękowej w kierunku czaszki. Wklęsłe końcówki, półostre na obrzeżu umożliwiają dodatkowo zbieranie kości do dalszego podnoszenia, co pozwala uzyskać stabilne oparcie do umieszczenia implantu.

Laser marked at 2mm intervals
Laserowe oznaczenie co 2 mm

Safety band at 10mm
Pasek bezpieczeństwa po 10 mm

TIN coated
Pokryte azotkiem tytanu

Laser marked size
Laserowe oznaczenie rozmiaru



Century-line 1908 - 2008 TIN coated / Pokryte azotkiem tytanu



DS.900.022
2.2 mm
Red



DS.900.028
2.8 mm
Green



DS.900.035
3.5 mm
Blue



DS.900.042
4.2 mm
Purple



DS.900.048
4.8 mm
Black



DS.910.022
2.2 mm
Red



DS.910.028
2.8 mm
Green



DS.910.035
3.5 mm
Blue



DS.910.042
4.2 mm
Purple



DS.910.048
4.8 mm
Black



DS.900.000
Set of 10 pieces / Zestaw 10 sztuk

Sinus lift cures / Kirety do podnoszenia dna zatoki

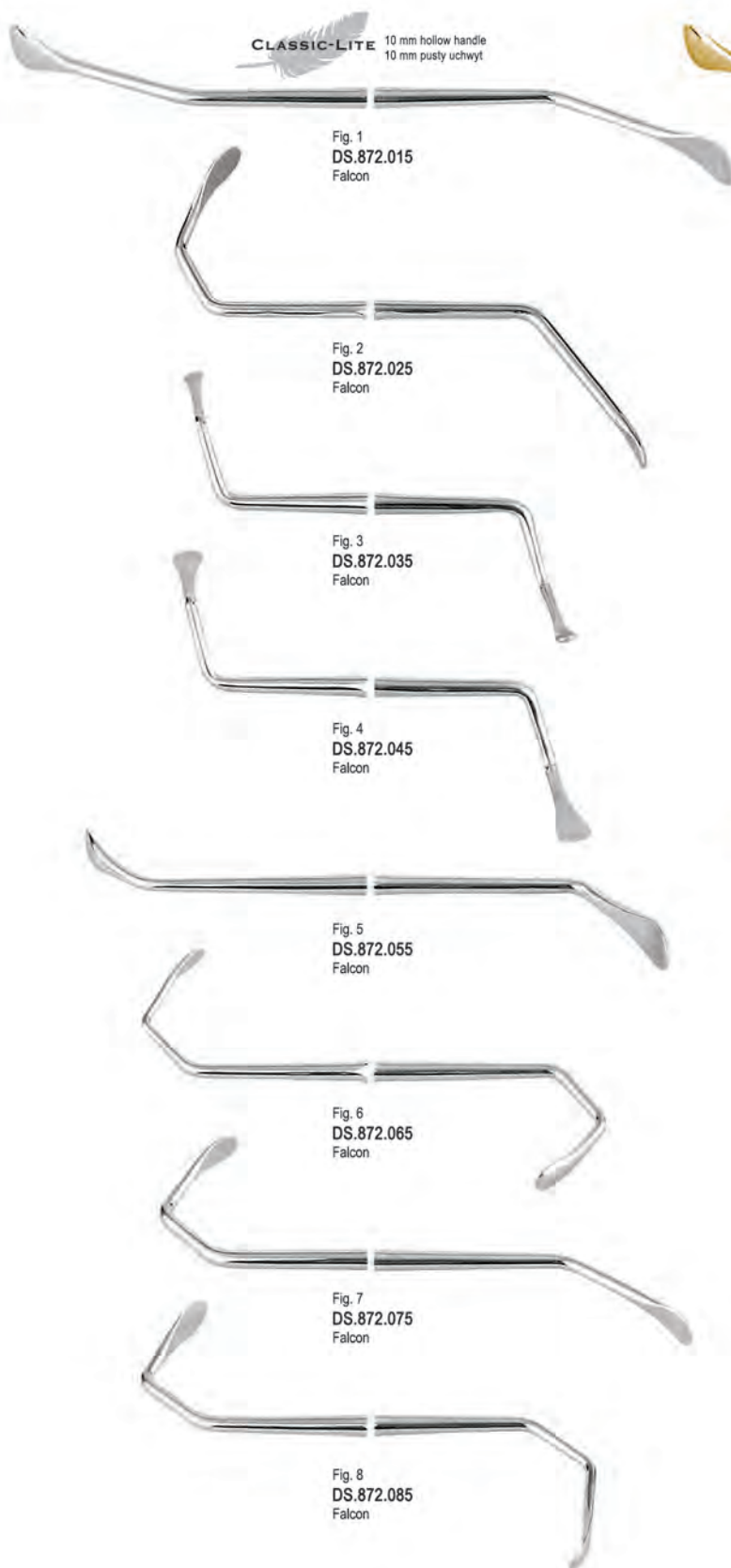

Sinus lift elevators / Elewatoria do podnoszenia dna zatoki



CLASSIC-LITE 10 mm hollow handle
10 mm pusty uchwyt



Fig. 1
DS.873.015
Falcon



Fig. 2
DS.873.025
Falcon



Fig. 3
DS.873.035
Falcon



Fig. 4
DS.873.045
Falcon



Fig. 5
DS.873.055
Falcon

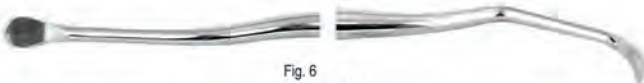

Fig. 6
DS.873.065
Falcon



Fig. 7
DS.873.075
Falcon

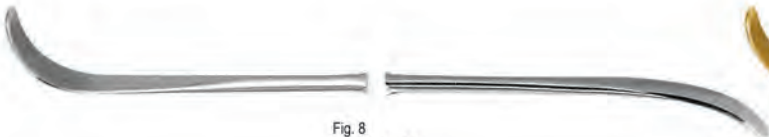

Fig. 8
DS.873.085
Falcon

Century-line 1908 - 2008
TIN coated / Pokryte azotkiem tytanu



Fig. 1
DS.873.013
Falcon



Fig. 2
DS.873.023
Falcon



Fig. 3
DS.873.033
Falcon



Fig. 4
DS.873.043
Falcon



Fig. 5
DS.873.053
Falcon



Fig. 6
DS.873.063
Falcon



Fig. 7
DS.873.073
Falcon



Fig. 8
DS.873.083
Falcon

Titanium implant periosteal elevators / Elewatoria tytanowe do implantologii

Easy
COLOR



Fig. 1 DS.832.011 Busar



Fig. 3 DS.839.031 Prichard

Implant periosteal elevators / Elewatoria do implantologii

CLASSIC-LITE

10 mm hollow handle
10 mm pusty uchwyt



Fig. 1 DS.832.015 Busar



Fig. 9A DS.830.091 Allen

Implant periosteal elevator / Elewatorium do implantologii



25 mm

Fig. 25 DS.828.250 170 mm

Periosteal elevators / Elewatoria

SOFT LINE INSTRUMENTS
soft and sure grip



Fig. 9 DP.666.094 Molt



Fig. 3 DP.665.034 Prichard



Fig. 3 DP.665.037 Prichard

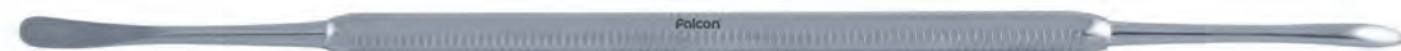
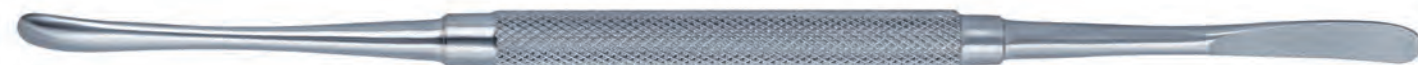

Fig. 9S DP.660.097S Molt slim



Fig. 9 DP.660.090 Molt



DP.660.010 Nordberg

CLASSIC-LITE

10 mm hollow handle
10 mm pusty uchwył

Periosteal elevators / Elewatoria



Fig. 15 DP.635.155 Freer



Fig. 16 DP.635.165 Freer



Fig. 14 DP.637.145 Goldman-Fox



Fig. 20 DP.640.205 Hirschfield



Fig. 1 DP.643.015 Hopkins



Fig. 2 DP.643.025 Hopkins



Fig. 3 DP.658.035 Mead/West



Fig. 9 DP.660.095 Molt



Fig. 3 DP.665.035 Prichard

Classic Round 6 mm solid handle
6 mm pełny uchwył

Knives gingivectomy / Noże do dziąseł

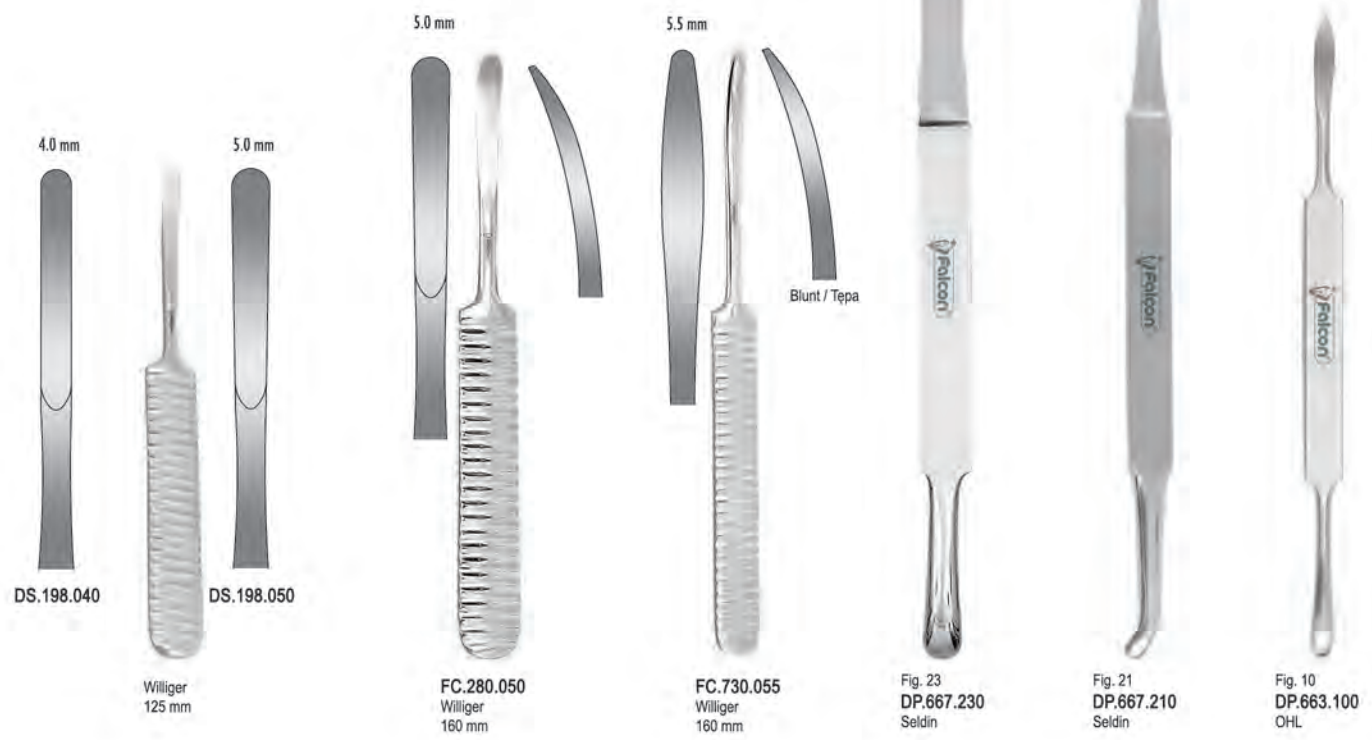

Fig. 1 DP.500.013 Orban



Fig. 2 DP.500.023 Orban

Elevators and raspatories
Skrobaczki i elewatoria



Knives gingivectomy / Noże do dziąseł



Classic Round 6 mm solid handle
6 mm pełny uchwyt

CLASSIC-LITE 10 mm hollow handle
10 mm pusty uchwyt

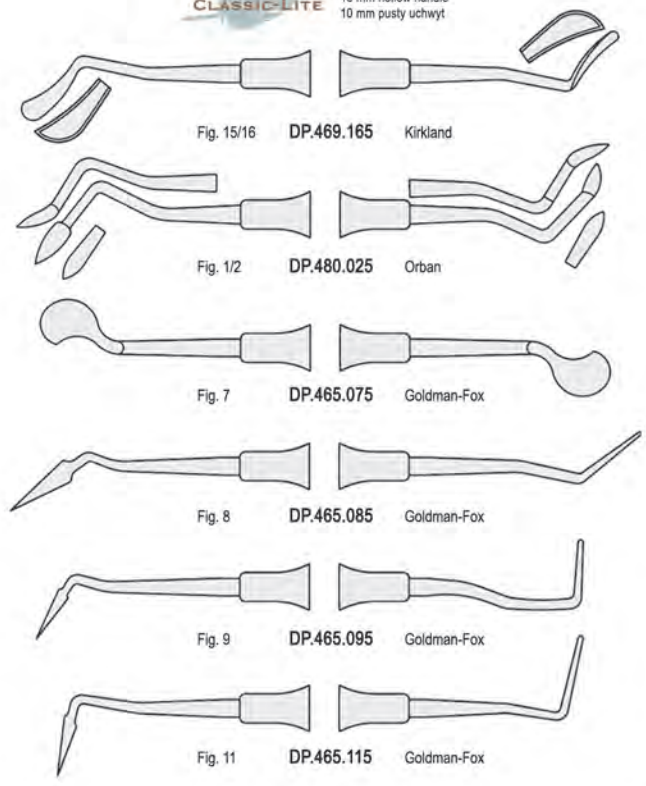
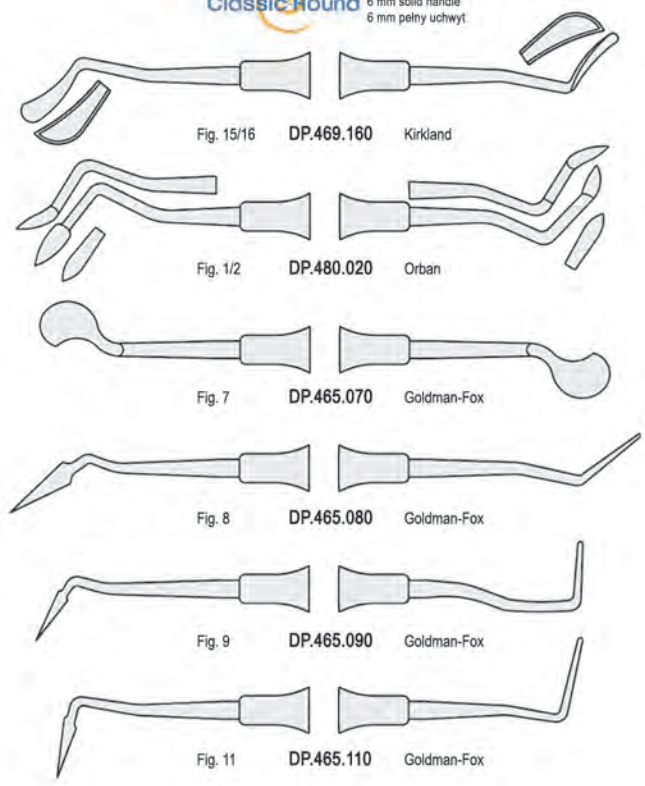

Tunneling instruments / Instrument do techniki tunelowej

The instruments for Vestibular Incision Subperiosteal Tunnel Access have been designed for its unique and innovative approach to soft tissue grafting and treatment of recessional defects

○ CLASSIC-LITE 10 mm hollow handle
10 mm pusty uchwyt



Fig. V-1
DP.550.015T



Fig. V-2
DP.550.025T



Fig. V-3
DP.550.035T



Fig. V-4
DP.550.045T



Fig. V-5
DP.550.055T



Fig. V-6
DP.550.065T



DP.550.000T
Set of 6 in cassette tray
Zestaw 6 sztuk + Kasetka

Soft brushing instruments / Szczoteczka do mobilizacji płata

The concept of the Soft Brushing is to disorganize the collagen fibers of the fibrous periosteum: the stiffness is reduced and the flap release increases just by using the brushes. The brush tools do not cut anything. The flap release is the result of the separation of the periosteum fibers.



Fig. 1
Straight / Prosta
DP.980.015T



Fig. 2
Left / Lewa
DP.980.025T



Fig. 3
Right / Prawa
DP.980.035T



Fig. 4
Medium / Średnia
DP.980.045T



Fig. 5
X-large / Bardzo duża
DP.980.055T



Set / Zestaw
DP.980.000T

Pocket markers / Szczypczyki



DP.705.150 Goldman-Fox Left / Lewe



DP.706.150 Goldman-Fox Right / Prawe

Chisels / Dłuta



DP.040.365 Rhodes 36 / 37

CLASSIC-LITE 10 mm hollow handle

Bone curettes / Łyzeczki zębodołowe

SOFT LINE INSTRUMENTS
soft and sure grip

CLASSIC-LITE

Classic Round

Hemingway

	Classic Round 6 mm solid handle 6 mm pełny uchwyt	CLASSIC-LITE 10 mm hollow handle 10 mm pusty uchwyt	SOFT LINE INSTRUMENTS soft and sure grip
Fig.1	DS.100.010	DS.100.015	DS.100.014
Fig. 2	DS.100.020	DS.100.025	DS.100.024
Fig. 3	DS.100.030	DS.100.035	DS.100.034
Fig. 4	DS.100.040	DS.100.045	DS.100.044

Bone curettes / Łyzeczki zębodołowe

Martini
135 mm

Fig. 00/0 OC.634.000 Fig. 0/1 OC.634.010 Fig. 1/2 OC.634.020

Williger
140 mm

Fig. 00/0 OC.640.000 Fig. 0/1 OC.640.010 Fig. 1/2 OC.640.020

CLASSIC-LITE

Bone curettes / Łyzeczki zębodołowe



Classic Round



Lucas

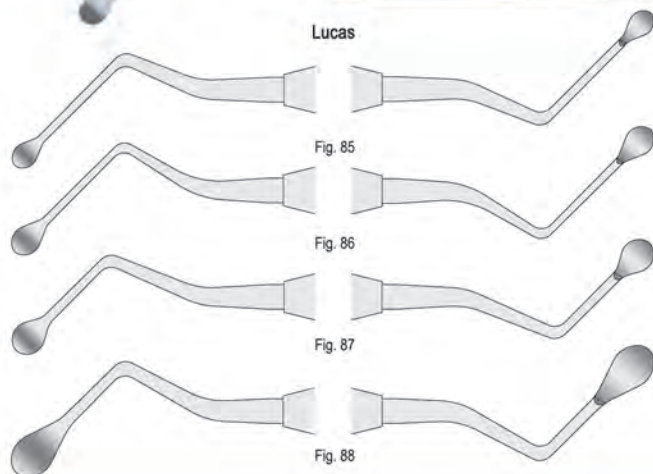

	Classic Round 6 mm solid handle 6 mm pełny uchwyt	CLASSIC-LITE 10 mm hollow handle 10 mm pusty uchwyt
Fig. 85	DS.110.850	DS.110.855
Fig. 86	DS.110.860	DS.110.865
Fig. 87	DS.110.870	DS.110.875
Fig. 88	DS.110.880	DS.110.885

Bone curettes / Łyzeczki zębodołowe

Classic-8
5.5 mm solid handle
5.5 mm pełny uchwyt

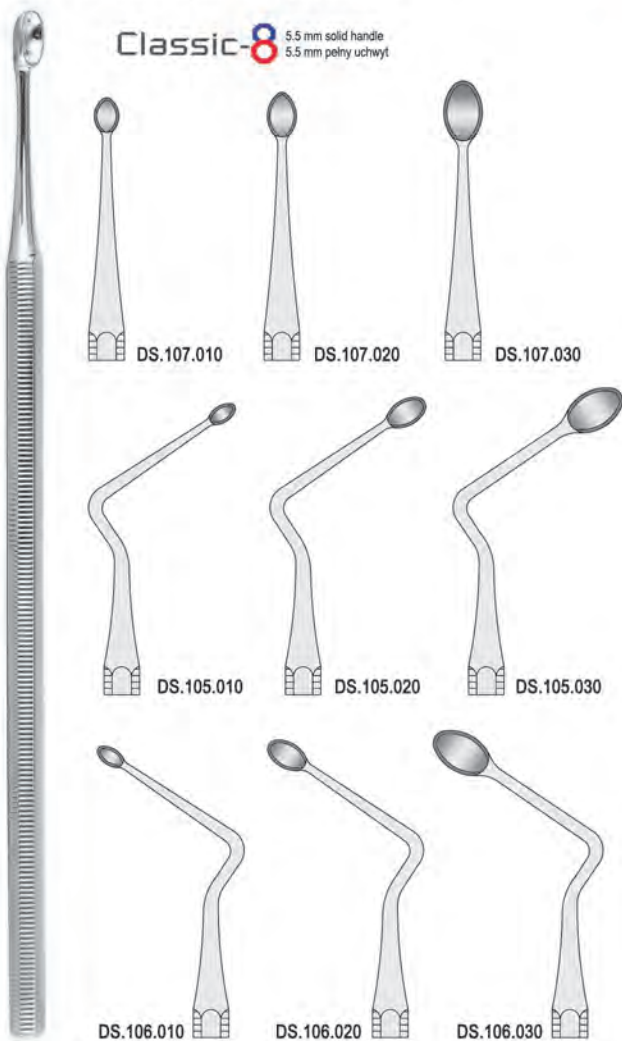

Bone curettes / Łyzeczki zębodołowe



Bone files / Pilniki kostne

CLASSIC-LITE 10 mm hollow handle
10 mm pusty uchwyt

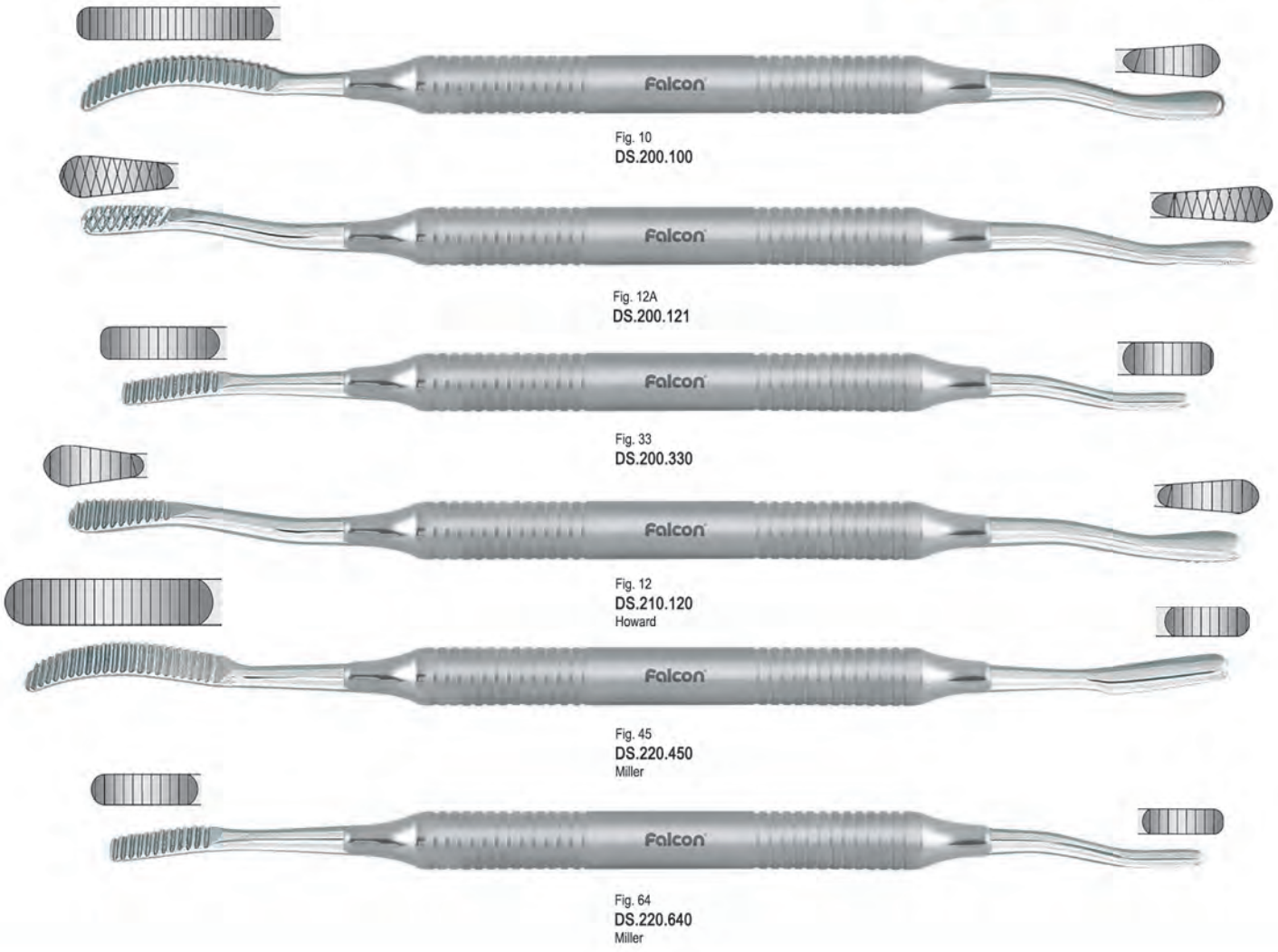

Chisels and gouges / Dłuta płaskie i żłobowe

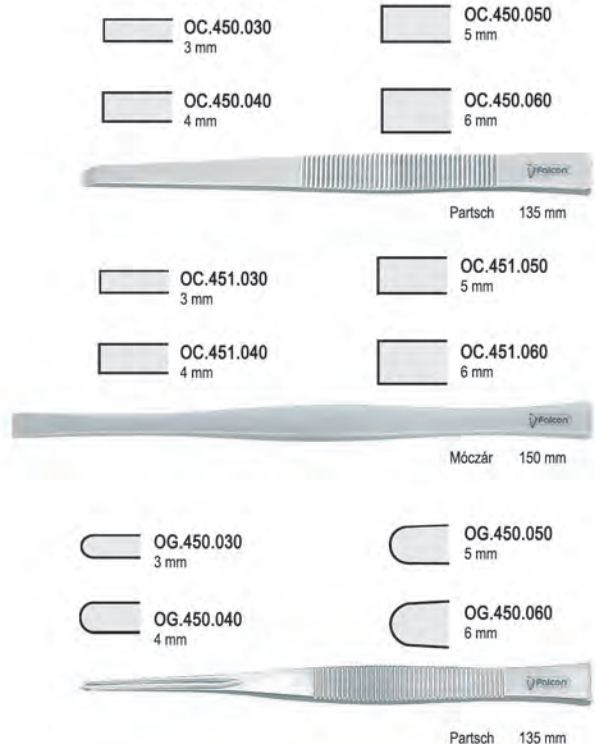
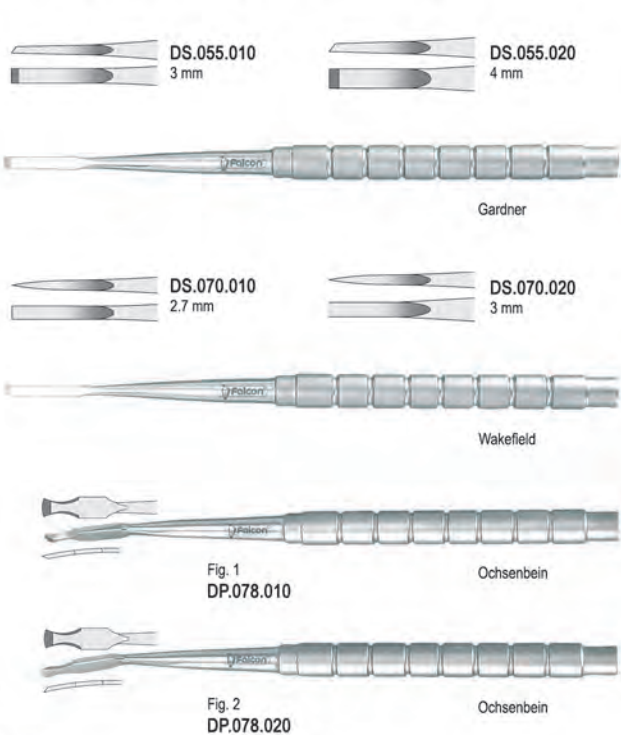

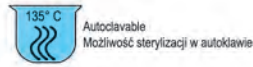

Mallets / Młotki



FC.420.010
Spare plastic disks, pair
Wymienne plastikowe dyski, para

FC.420.185
Falcon
185 mm



FC.435.010
Spare plastic disks, pair
Wymienne plastikowe dyski, para

FC.435.190
Mead
190 mm



Lead filled Head
Końcówka wypełniona ołowiem

DS.271.190
Parsch
190 mm



Stainless Steel Head
Końcówka ze stali nierdzewnej

DS.270.190
Parsch
190 mm

Bone cutters / Kleszce do cięcia kości



DS.503.100
Goldman-Fox
100 mm



OC.850.145
Cleveland
145 mm



Fig. 14
DS.508.140
Falcon
165 mm

**Surgical instrument spray lubricant
Olej do konserwacji narzędzi w aerozolu**



- Warstwa oleju przepuszczalna dla pary
- Warstwa oleju nie zaburza skuteczności sterylizacji
- Smaruje i zabezpiecza przeciw korozji
- Nie zawiera silikonu, nie tworzy plam i osadu na powierzchni narzędzi

SS.2004.00
300ml

Bone rongeurs / Odgryzacz kostne



OR.740.125
Friedmann-Mini
125 mm

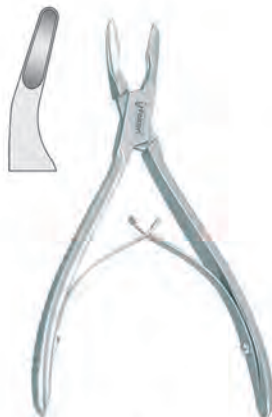

OR.741.140
Friedmann
140 mm



OR.770.150
Luer
150 mm



OR.775.165
Mead
165 mm

Bone rongeurs / Odgryzacze kostne

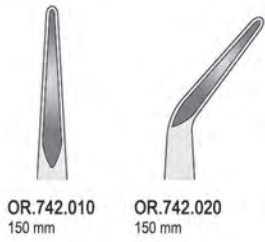

OR.742.020
150 mm

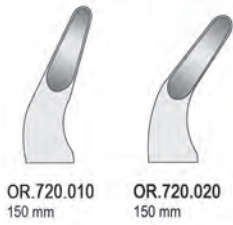

OR.720.020
150 mm

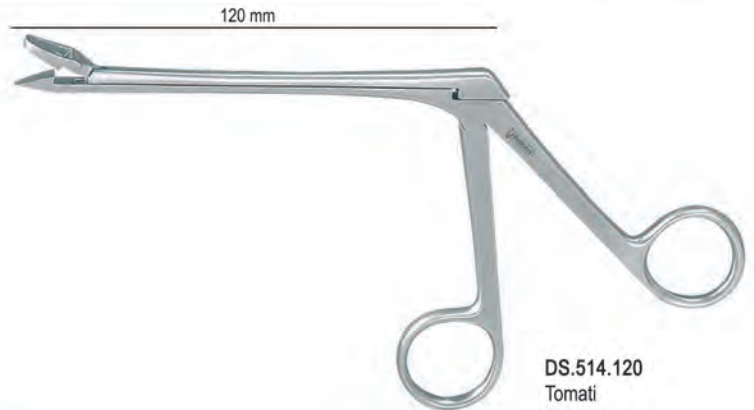

Lips and cheek retractors / Rozwieraki do policzków i ust





Lips and cheek retractors / Rozwieraki do policzków i ust



30 x 19 mm

33 x 25 mm

FB.330.150
Kliner
150 mm



DS.375.000
Austin-Minnesota



Autoclavable
Możliwość sterylizacji w autoklawie



Fig. 2
DS.375.020
Austin



DS.380.010
Bishop
140mm



FB.430.010
120 mm

FB.430.020
140 mm

FB.430.030
150 mm



DS.389.145
Columbia
145 mm



DS.427.030
Oringer
115 mm



FB.310.200
Falcon
200 mm



DS.405.010
Hilger
Fits any simple
stem mouth mirror
handle
Pasuje do każdego
prostego uchwytu
do lusterek

DS.405.000
Hilger
with handle / z uchwytem

**Mouth props silicone
Rozwieraki silikonowe**



DS.370.030
Large / Duży
Pack of 6 pieces
+ 1 cheek support
Opak.6 szt. + 1 uchwyt



DS.370.010
Small / Mały
Pack of 6 pieces
+ 1 cheek support
Opak.6 szt. + 1 uchwyt



Cheek holder for mouth props
Uchwyt do silikonowego rozwieraka

DS.370.000
cheek support / uchwyt

**Mouth props, silicone with metal insert
Podkładki do rozwieraków, silikonowe z rdzeniem metalowym**



Autoclavable
Możliwość sterylizacji w autoklawie



FB.035.010 Small / Mały
FB.035.020 Medium / Średnie
FB.035.030 Large / Duże



DS.371.000
Mouth prop set silicone, 6 x small, 6 x Large
with 2 cheek support (Pack of 14 pieces)
Zestaw rozwieraków silikonowych
Mały x 6, Duży x 6 z 2 uchwytami (Opak.14 szt.)

Mouth props rubber
Podkładki gumowe do rozwieraków

Pack of 10 pieces
Opak. 10 szt.



Falcon
FB.037.010 Small / Mały
FB.037.020 Medium / Średnie
FB.037.030 Large / Duży
Cold Sterilization only / Sterylizować na zimno

Finger protectors / Ochraniacz palca



FB.030.010 Small / Mały
FB.030.020 Medium / Średni
FB.030.030 Large / Duży

Langenbeck

Mouth gags / Rozwieracze szczękowe



Molt				
FB.065.100	100 mm	FB.060.130	Heister	130 mm
FB.065.110	110 mm			
FB.065.140	140 mm	FB.085.160	160 mm	FB.085.190
		Roser-König	190 mm	Denhart
				125 mm

Retractors / Haki



42 x 10 mm	72 x 11 mm
FC.900.042	FC.903.220
Obwegeser	Obwegeser
220 mm	220 mm

Tongue depressors / Łopatki do języka

Disposable wooden tongue depressors
Jednorazowe łopatki do języka drewniane



FB.250.010	FB.250.020	FB.255.145	FB.256.180	FB.260.190	FB.298.010	FB.298.020	Wieder
14 x 1.6 mm	18 x 1.6 mm	Falcon	Buchwald	Bruenings	140 mm	150 mm	
140 mm	150 mm	145 mm	180 mm	190 mm			

Pack of 100 pieces
Opak. 100 szt.

Scalpel blades / Ostrza do skalpeli

Sterile, Individually Packed,
Box of 100 Pieces

Sterylnie. Pakowane osobno.
Opak.zawiera 100 szt.



Fig.10



Fig.11



Fig.12



Fig.12D



Fig.13



Fig.15



Fig.15C

Falcon	BK.500.100	BK.500.110	BK.500.120	BK.500.122	BK.500.130	BK.500.150	BK.500.152
Swann-Morton	BK.505.100	BK.505.110	BK.505.120	BK.505.122	BK.505.130	BK.505.150	BK.505.152



Fig.20



Fig.21



Fig.22



Fig.23



Fig.24



Fig.25

Falcon	BK.500.200	BK.500.210	BK.500.220	BK.500.230	BK.500.240	BK.500.250
Swann-Morton	BK.505.200	BK.505.210	BK.505.220	BK.505.230	BK.505.240	BK.505.250

Disposable scalpels / Jednorazowe skalpele

Sterile, Individually Packed, Box of 10 Pieces
Sterylnie. Pakowane osobno. Opak.zawiera 10 szt.



Fig. 11
BK.025.110



Fig. 12D
BK.025.122



Fig. 15C
BK.025.152



Fig. 15
BK.025.150



Fig. 10 BK.026.100



Fig. 10A BK.026.101

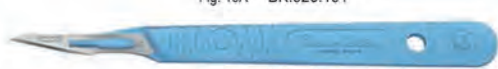

Fig. 11 BK.026.110

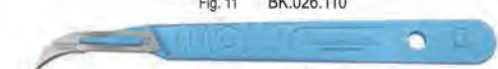

Fig. 12 BK.026.120

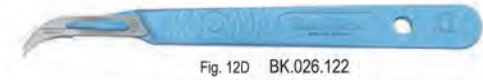

Fig. 12D BK.026.122



Fig. 15 BK.026.150

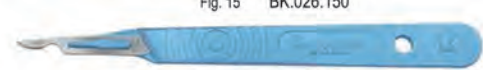

Fig. 15C BK.026.152



Fig. 19 BK.026.190

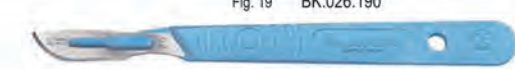

Fig. 20 BK.026.200



Scalpel handles / Uchwyty do skalpeli

For scalpel blades No
Pasują do ostrzy nr
10, 11, 12, 12D, 13, 15, 15C

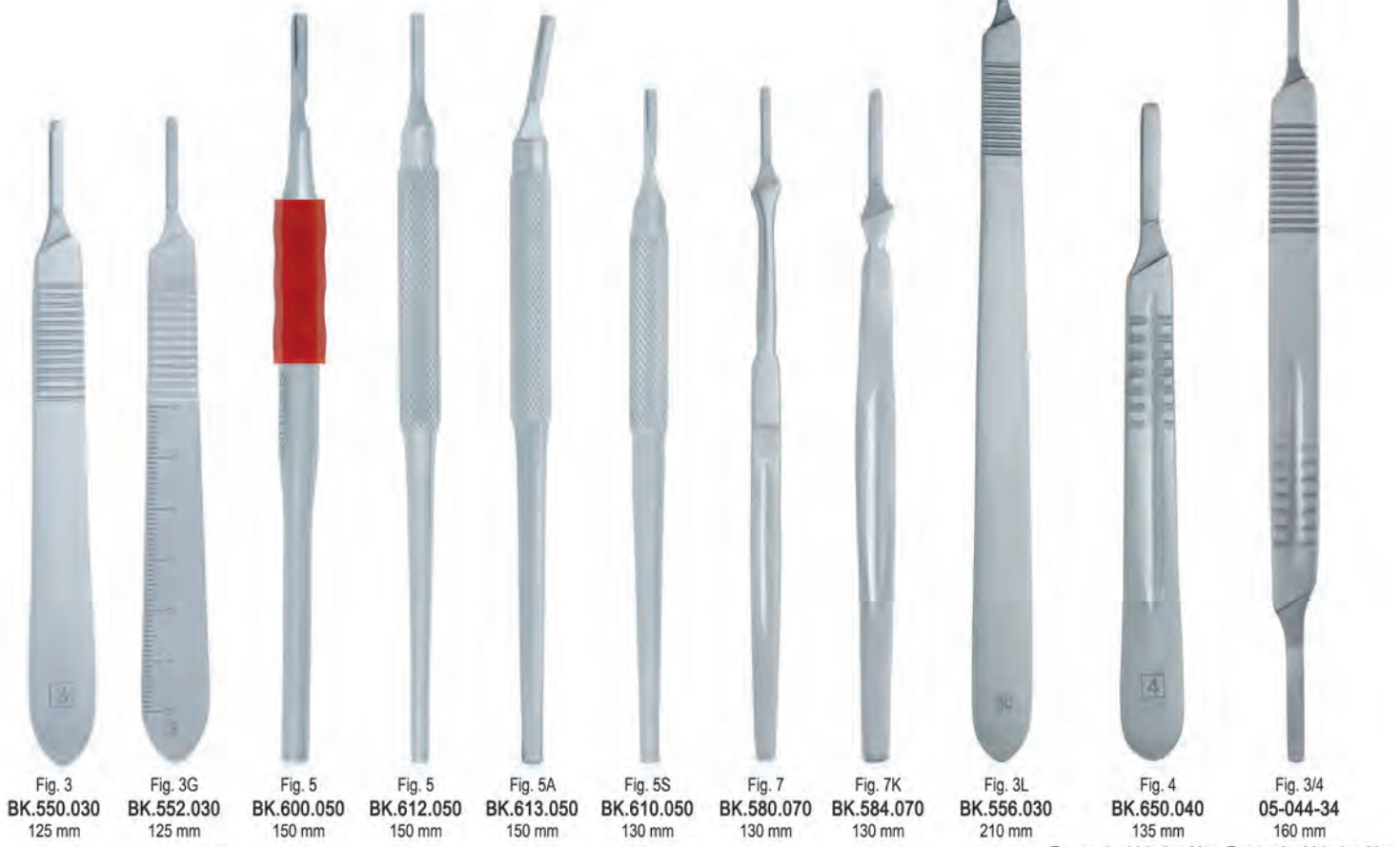

Fig. 3 BK.550.030 125 mm	Fig. 3G BK.552.030 125 mm	Fig. 5 BK.600.050 150 mm	Fig. 5 BK.612.050 150 mm	Fig. 5A BK.613.050 150 mm	Fig. 5S BK.610.050 130 mm	Fig. 7 BK.580.070 130 mm	Fig. 7K BK.584.070 130 mm	Fig. 3L BK.556.030 210 mm	Fig. 4 BK.650.040 135 mm	Fig. 3/4 05-044-34 160 mm
--------------------------------	---------------------------------	--------------------------------	--------------------------------	---------------------------------	---------------------------------	--------------------------------	---------------------------------	---------------------------------	--------------------------------	---------------------------------

For scalpel blades No / Pasują do ostrzy nr :
10, 11, 12, 12D, 13, 15, 15C

For scalpel blades No
Pasuje do ostrzy nr :
20, 21, 22, 23, 24, 25

For scalpel blades No
Pasuje do ostrzy nr :
20, 21, 22, 23, 24, 25

Safety forceps for fitting and removing scalpel blades
Przyrząd do zdejmowania ostrzy do skalpela

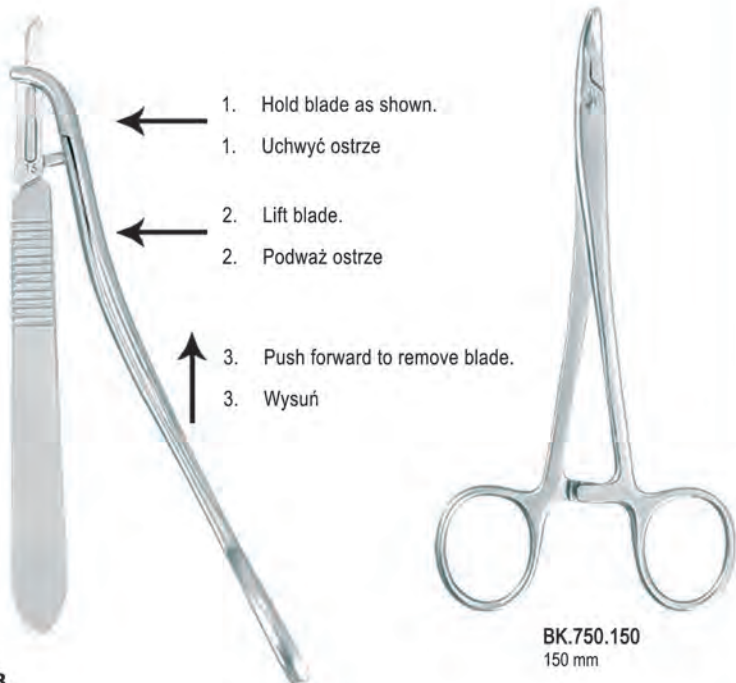

1. Hold blade as shown.
1. Uchwycić ostrze
2. Lift blade.
2. Podważ ostrze
3. Push forward to remove blade.
3. Wysuń

BK.750.150
150 mm

Scalpels stainless steel
Skalpele ze stali nierdzewnej



Fig. 4 BK.150.040 35 mm	Fig. 5 BK.150.050 40 mm	Fig. 6 BK.150.060 45 mm	Fig. 7 BK.150.070 50 mm
-------------------------------	-------------------------------	-------------------------------	-------------------------------



Scissors with tungsten carbide edges
 Key features
 Extremely smooth cutting with less trauma.
 Manufactured from high quality stainless steel and tungsten carbide inserts for longer-lasting cutting edge.
 Gold plated rings.

Nożyczki z ostrzami z węgla spiekanego
 Cechy
 Tną bardzo precyzyjnie.
 Wykonane z wysokiej jakości stali nierdzewnej i węgla spiekanego dla zapewnienia precyzji cięcia.
 Uchwyt pokryty złotem.

**3 Years
Guarantee**

**3 lata
Gwarancji**

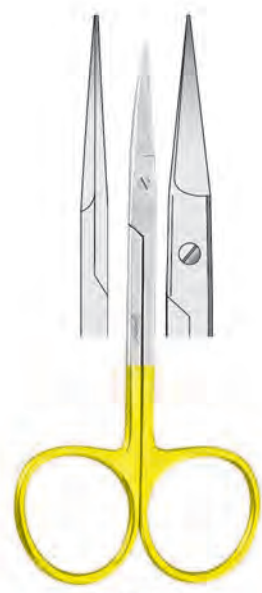

BS.100.115
Iris
115 mm



BS.101.115
Iris
115 mm



BS.107.115
La Grange
115 mm

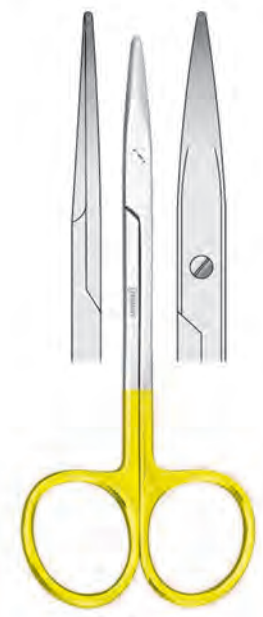

BS.118.115
Falcon strabismus
115 mm

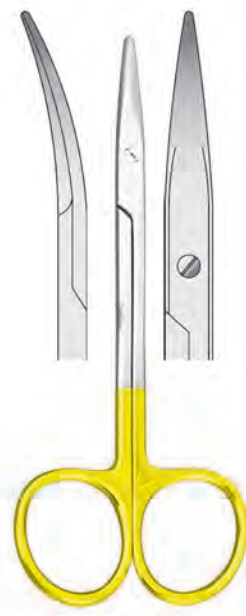

BS.119.115
Falcon strabismus
115 mm



DS.596.120
Falcon
120 mm



DS.597.120
Falcon
120 mm



Scissors with tungsten carbide edges
Key features
Extremely smooth cutting with less trauma.
Manufactured from high quality stainless steel and tungsten carbide inserts for longer-lasting cutting edge.
Gold plated rings.

Nożyczki z ostrzami z węgla spiekanego
Cechy
Tną bardzo precyzyjnie.
Wykonane z wysokiej jakości stali nierdzewnej i węgla spiekanego dla zapewnienia precyzji cięcia.
Uchwyt pokryty złotem.

3 Years
Guarantee

3 lata
Gwarancji



DS.600.130
Goldman-Fox
130 mm



DS.601.130
Goldman-Fox
130 mm

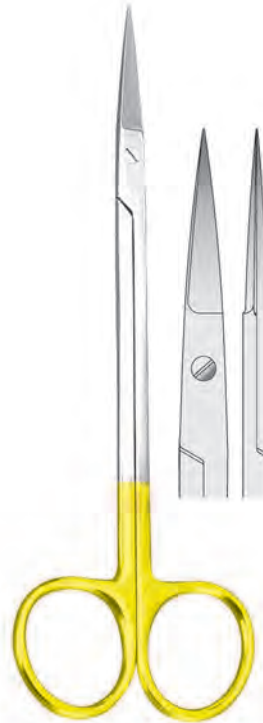

BS.136.160
Kelly
160 mm

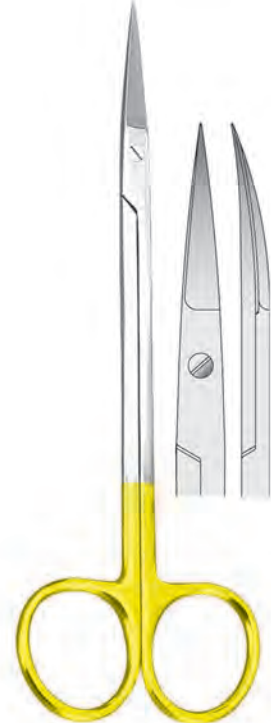

BS.136.160
Kelly
160 mm



Falcon - Standard
145 mm
blunt-blunt / tępo-tępe

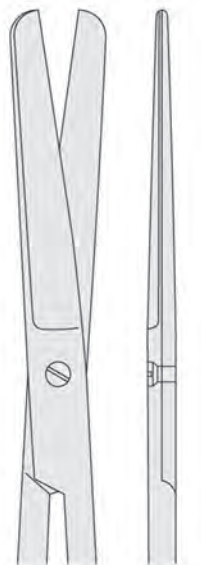

BS.150.145



Falcon - Standard
145 mm
blunt-blunt / tępo-tępe



BS.151.145



Falcon - Standard
145 mm
blunt-sharp / tępo-ostre

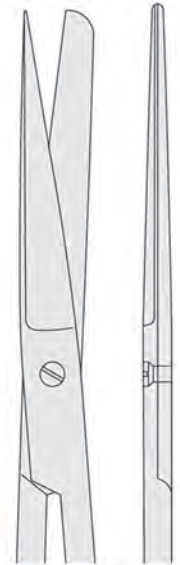

BS.152.145

**3 Years
Guarantee**

**3 lata
Gwarancji**

Scissors with tungsten carbide edges
Key features
Extremely smooth cutting with less trauma.
Manufactured from high quality stainless steel and tungsten carbide inserts for longer-lasting cutting edge.
Gold plated rings.

Nożyczki z ostrzami z węgla spiekanego
Cechy
Tną bardzo precyzyjnie.
Wykonane z wysokiej jakości stali nierdzewnej i węgla spiekanego dla zapewnienia precyzji cięcia.
Uchwyt pokryty złotem.



Falcon - Standard
145 mm
sharp-sharp / ostro-ostre

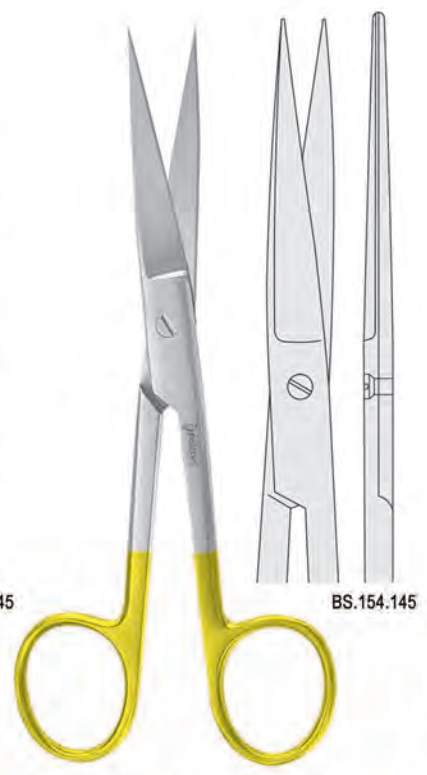

Falcon - Standard
145 mm
sharp-sharp / ostro-ostre



Falcon - Standard
145 mm
sharp-sharp / ostro-ostre



Mayo - Stille
150 mm



BS.172.150
150 mm
BS.172.170
170 mm

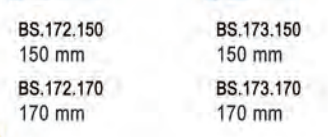

BS.173.150
150 mm
BS.173.170
170 mm



Mayo
145 mm

BS.170.145 **BS.171.145**



Scissors with tungsten carbide edges
Key features
Extremely smooth cutting with less trauma.
Manufactured from high quality stainless steel and tungsten carbide inserts for longer-lasting cutting edge.
Gold plated rings.

Nożyczki z ostrzami z węgla spiekanego
Cechy
Tną bardzo precyzyjnie.
Wykonane z wysokiej jakości stali nierdzewnej i węgla spiekanego dla zapewnienia precyzji cięcia.
Uchwyt pokryty złotem.

3 Years
Guarantee

3 lata
Gwarancji

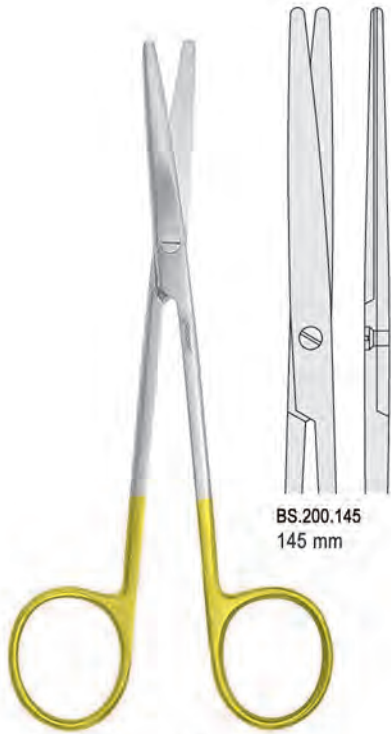

BS.200.145
145 mm

Metzenbaum

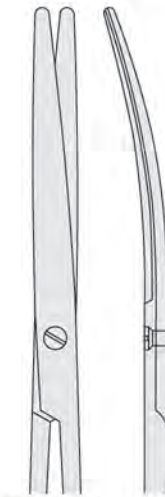

BS.201.145
145 mm

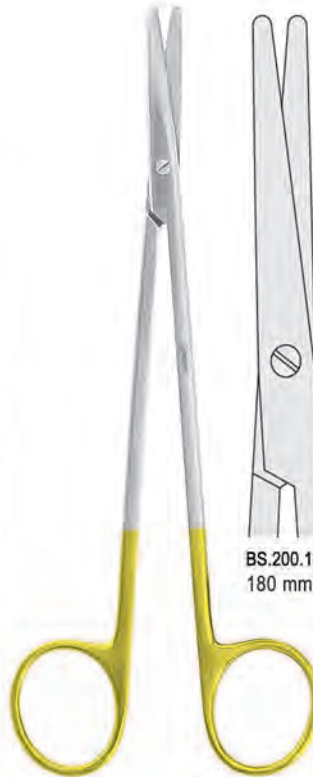

BS.200.180
180 mm

Metzenbaum

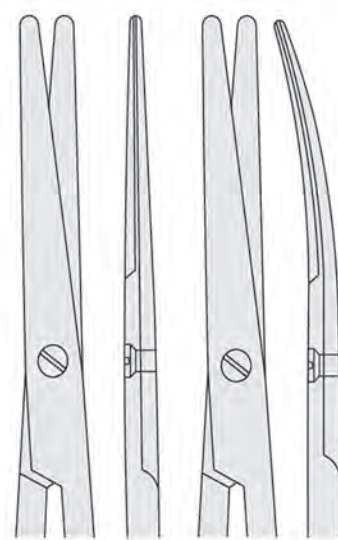

BS.201.180
180 mm

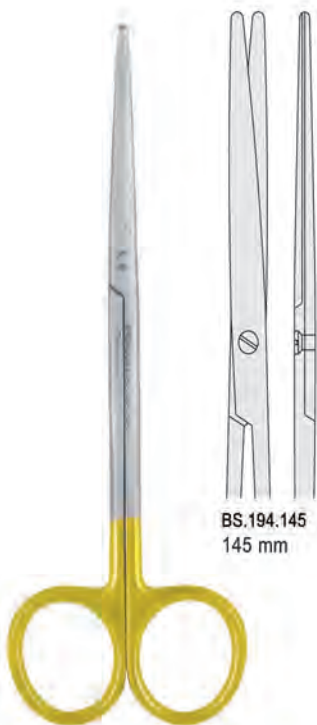

BS.194.145
145 mm

Metzenbaum Fino



BS.195.145
145 mm

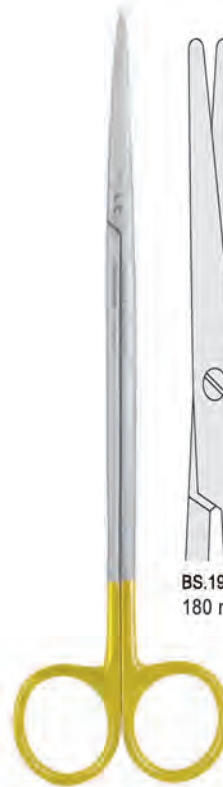

BS.194.180
180 mm

Metzenbaum Fino

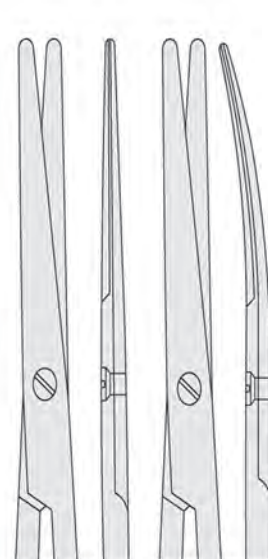

BS.195.180
180 mm

Super-Cut scissors

Key Features

Cutting blade honed to "razor" sharpness with opposing blade finished with fine serrations to avoid tissue slippage. Extremely smooth cutting with less trauma. Manufactured from high quality stainless steel for longer-lasting cutting edge. Single gold plated ring for easy identification.

Nożyczki Super-Cut

Cechy

Jedno z ostrzy nożyczek jest bardzo ostre, a drugie zakończone jest ząbkami, aby uniknąć wyslizgiwania się tkanki. Tną bardzo precyzyjnie. Wykonane z wysokiej jakości stali nierdzewnej dla zapewnienia precyzji cięcia. Złota część uchwytu pozwala na łatwą identyfikację instrumentu.



Iris
115 mm

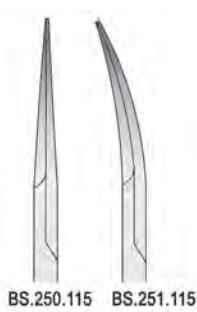

BS.250.115 BS.251.115



La Grange
115 mm



BS.257.115



Falcon
120 mm



DS.560.120 DS.561.120



Goldman-Fox
130 mm

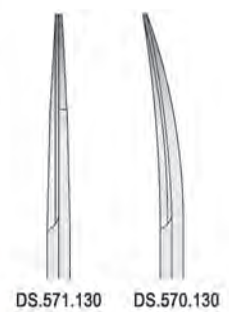

DS.571.130 DS.570.130



Falcon - Standard
145 mm
blunt-blunt / tępo-tępe

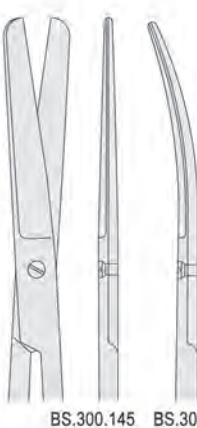

BS.300.145 BS.301.145



Falcon - Standard
145 mm
blunt-sharp / tępo-ostre



BS.302.145 BS.303.145

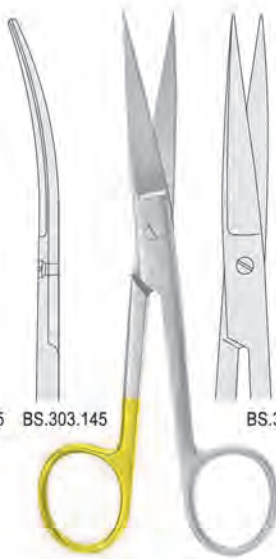

Falcon - Standard
145 mm
sharp-sharp / ostro-ostre



BS.304.145 BS.305.145

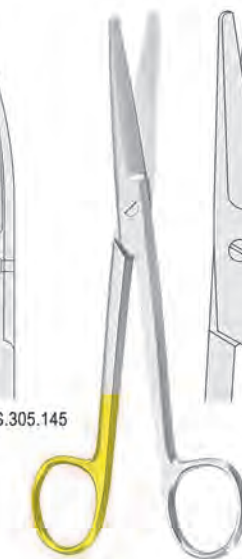

Mayo
145 mm

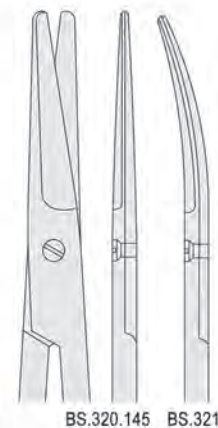

BS.320.145 BS.321.145

Scissors, one blade serrated

Key Features

One blade is with fine serrations to avoid tissue or ligature slippage.
Manufactured from high quality stainless steel for longer-lasting cutting edge.
Single black ring for easy identification.

Nożyczki, jedno ostrze ząbkowane

Cechy

Jedno ostrze jest ząbkowane w celu uniknięcia "wyslizgiwania się" tkanki lub nici.
Wykonane z wysokiej jakości stali nierdzewnej dla zapewnienia precyzji cięcia.
Czarna część uchwytu pozwala na łatwą identyfikację instrumentu.



Falcon
120 mm / 4 3/4"

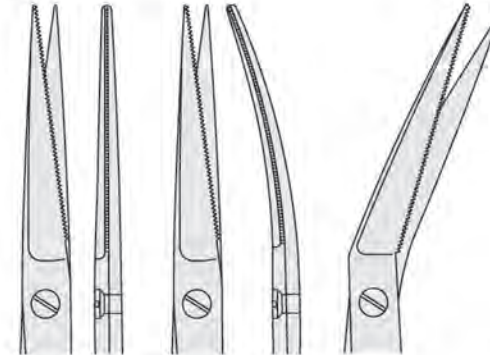

DS.530.120 DS.531.120 DS.533.120



Goldman-Fox
DS.539.011
130 mm / 5 1/8"



Goldman-Fox
130 mm / 5 1/8"

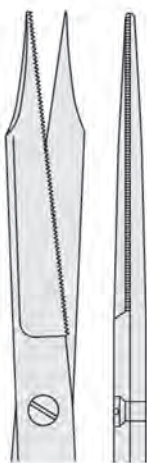

DS.536.011



DS.537.011



Locklin
DS.540.160
160 mm / 6 1/4"

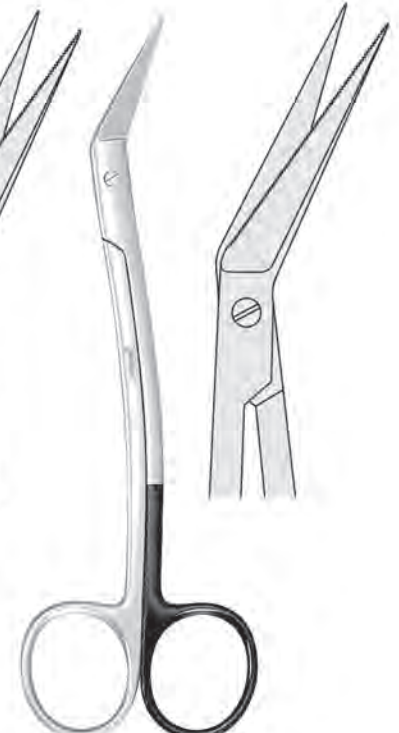

Locklin
DS.541.160
160 mm / 6 1/4"

Delicate scissors / Nożyczki delikatne

Titanium
Tytanowe

Titanium
Tytanowe



BS.504.120T
Noyes / Castroviejo
Straight / Proste
120mm



BS.505.120T
Noyes / Castroviejo
Curved / Zagięte
120mm



06-867-11T
Westcott
Straight / Proste
115mm



06-868-11T
Westcott
Curved / Zagięte
115mm



Noyes / Castroviejo
120mm



BS.504.120



BS.505.120



BS.506.115
115mm



Westcott
115mm



06-867-11



06-868-11



Iris

Titanium
Tytanowe

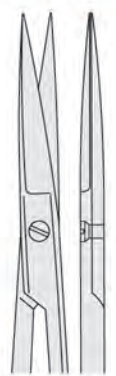

BS.540.115T
115 mm / 4 1/2"

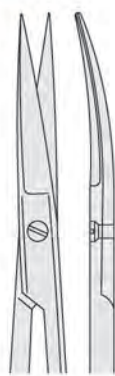

BS.541.115T
115 mm / 4 1/2"



Iris



BS.540.090
90 mm / 3 1/2"



BS.541.090
90 mm / 3 1/2"

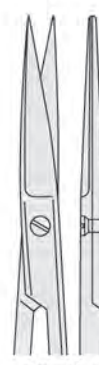

BS.540.105
105 mm / 4 1/8"

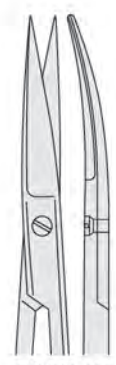

BS.541.105
105 mm / 4 1/8"

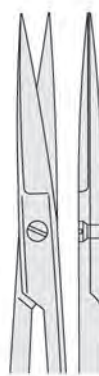

BS.540.115
115 mm / 4 1/2"

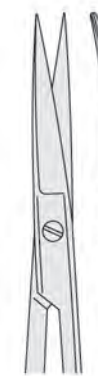

BS.541.115
115 mm / 4 1/2"

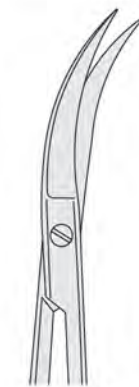

BS.542.115
115 mm / 4 1/2"

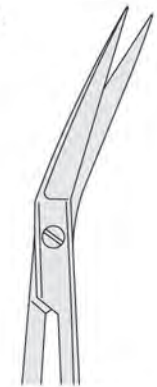

BS.543.115
115 mm / 4 1/2"

Delicate scissors / Nożyczki delikatne



Delicate scissors / Nożyczki delikatne

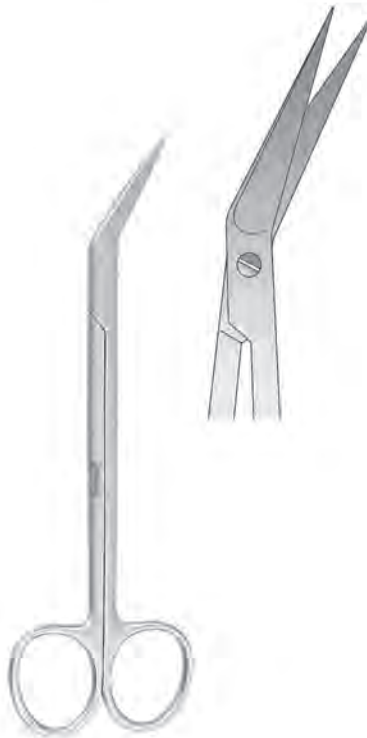

Kelly
BS.639.160
160 mm / 6 1/4"

Operating scissors / Nożyczki operacyjne

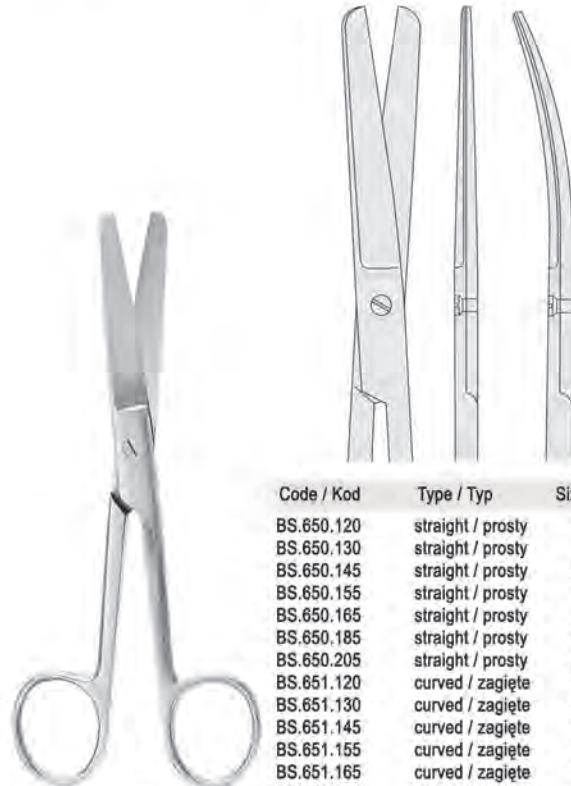

Falcon - Standard
blunt-blunt / tępo-tępe

Code / Kod	Type / Typ	Size / Długość
BS.650.120	straight / prosty	120mm
BS.650.130	straight / prosty	130mm
BS.650.145	straight / prosty	145mm
BS.650.155	straight / prosty	155mm
BS.650.165	straight / prosty	165mm
BS.650.185	straight / prosty	185mm
BS.650.205	straight / prosty	205mm
BS.651.120	curved / zagięte	120mm
BS.651.130	curved / zagięte	130mm
BS.651.145	curved / zagięte	145mm
BS.651.155	curved / zagięte	155mm
BS.651.165	curved / zagięte	165mm
BS.651.185	curved / zagięte	185mm
BS.651.205	curved / zagięte	205mm

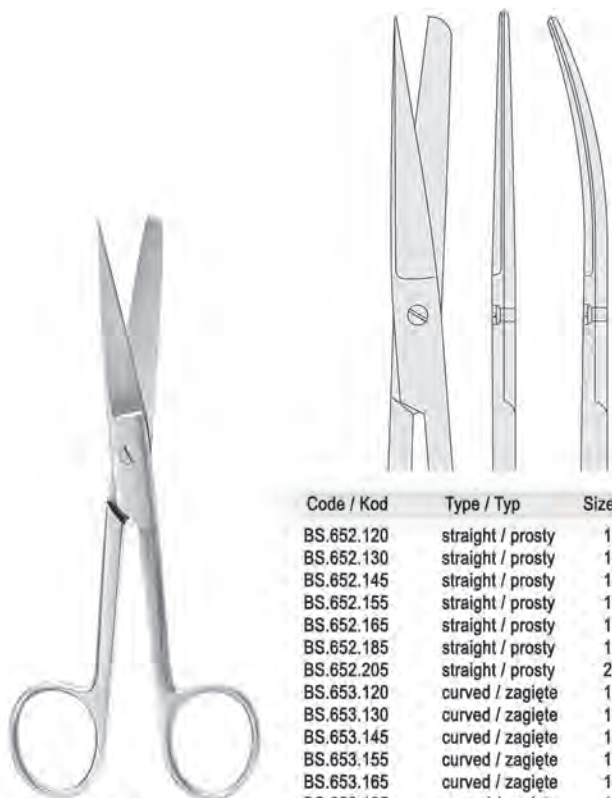

Falcon - Standard
blunt-sharp / tępo-ostre

Code / Kod	Type / Typ	Size / Długość
BS.652.120	straight / prosty	120mm
BS.652.130	straight / prosty	130mm
BS.652.145	straight / prosty	145mm
BS.652.155	straight / prosty	155mm
BS.652.165	straight / prosty	165mm
BS.652.185	straight / prosty	185mm
BS.652.205	straight / prosty	205mm
BS.653.120	curved / zagięte	120mm
BS.653.130	curved / zagięte	130mm
BS.653.145	curved / zagięte	145mm
BS.653.155	curved / zagięte	155mm
BS.653.165	curved / zagięte	165mm
BS.653.185	curved / zagięte	185mm
BS.653.205	curved / zagięte	205mm

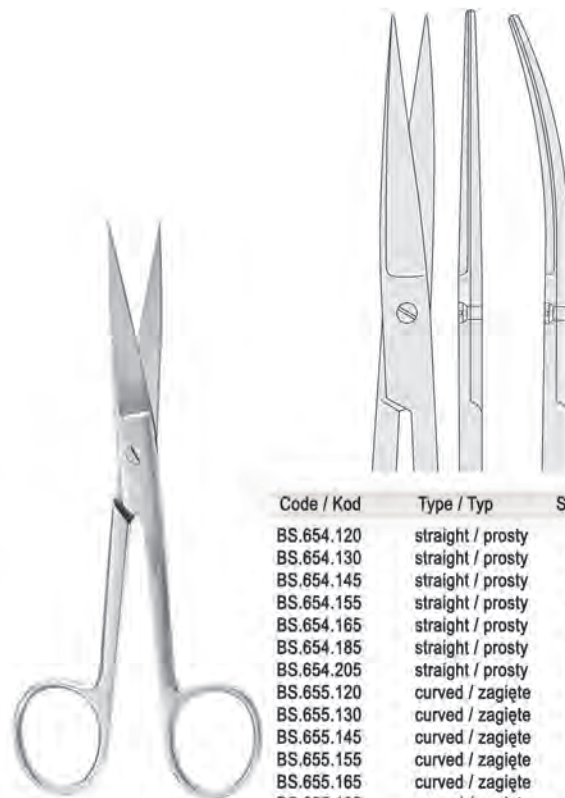

Falcon - Standard
sharp-sharp / ostro-ostre

Code / Kod	Type / Typ	Size / Długość
BS.654.120	straight / prosty	120mm
BS.654.130	straight / prosty	130mm
BS.654.145	straight / prosty	145mm
BS.654.155	straight / prosty	155mm
BS.654.165	straight / prosty	165mm
BS.654.185	straight / prosty	185mm
BS.654.205	straight / prosty	205mm
BS.655.120	curved / zagięte	120mm
BS.655.130	curved / zagięte	130mm
BS.655.145	curved / zagięte	145mm
BS.655.155	curved / zagięte	155mm
BS.655.165	curved / zagięte	165mm
BS.655.185	curved / zagięte	185mm
BS.655.205	curved / zagięte	205mm

Operating scissors / Nożyczk operacyjne

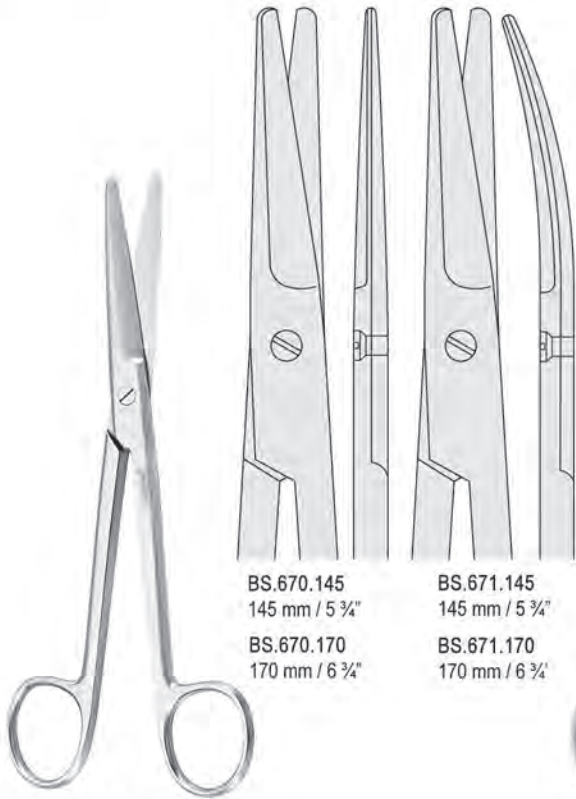

Mayo

BS.670.145
145 mm / 5 ¾"

BS.670.170
170 mm / 6 ¾"

BS.671.145
145 mm / 5 ¾"

BS.671.170
170 mm / 6 ¾"

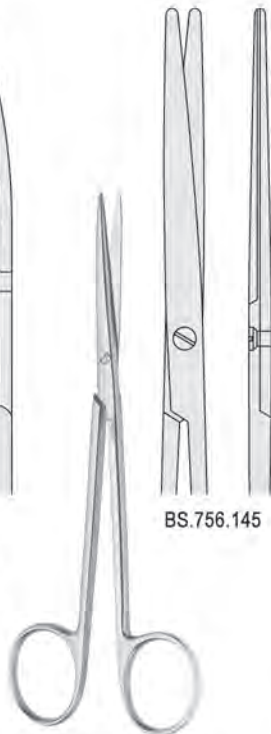

Metzenbaum-Delicate
145 mm / 5 ¾"

BS.756.145

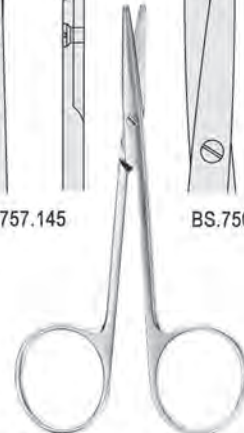
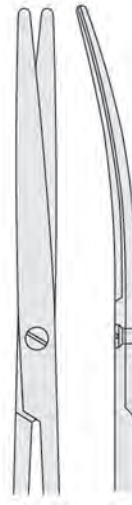

Baby-Metzenbaum
115 mm / 4 ½"

BS.757.145



BS.750.115



BS.751.115

Bandage scissors / Nożyczki do bandaża

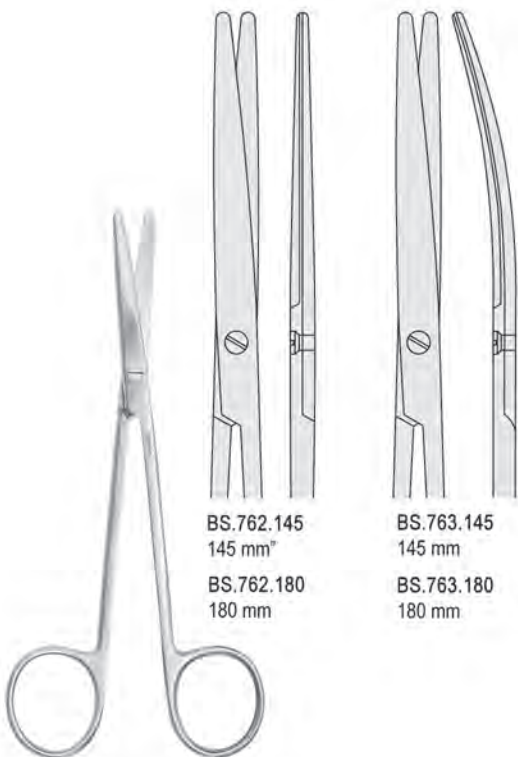

Metzenbaum

BS.762.145
145 mm

BS.762.180
180 mm

BS.763.145
145 mm

BS.763.180
180 mm



Lister
BS.943.090 90 mm / 3 ½"
BS.943.110 110 mm / 4"
BS.943.145 145 mm / 5 ¾"
BS.943.180 180 mm / 7"
BS.943.200 200 mm / 8"



Universal
180 mm / 7"
BS.966.010

Suture scissors / Nożyczki do nitek

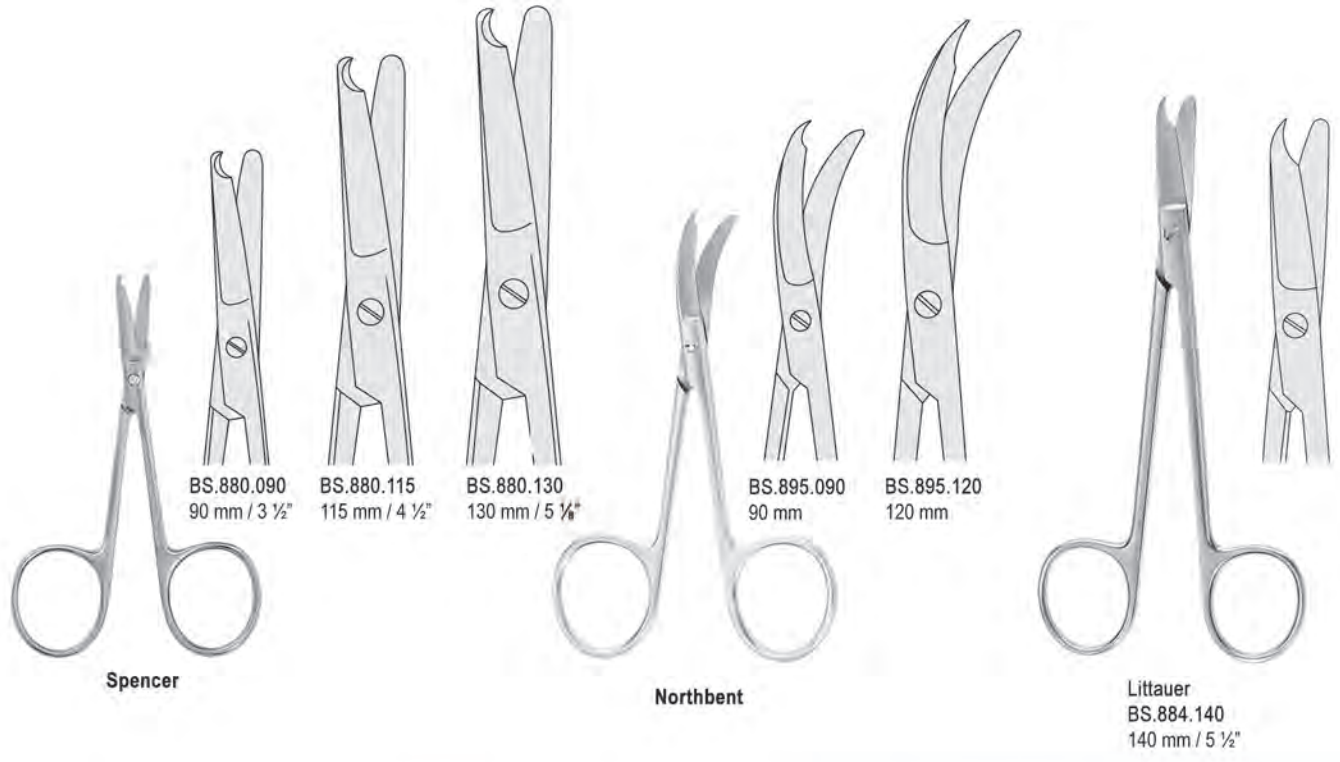

Atraumatic forceps / Pensety atraumatyczne



Dissecting forceps / Pensety anatomiczne

**Titanium
Titanio
Tytanowe**

Falcon
GRIP

Forceps with tungsten carbide inserts
Pensety z wkładką z węgla spiekanego



Adson
120 mm / 4 3/4"



BD.054.120



Bishop-Harmon
BD.1501.90
90 mm



Adson
120 mm / 4 3/4"



BD.200.120



Adson-Micro



BD.360.120
120 mm / 4 3/4"



BD.360.150
150 mm / 6"



Adson



BD.370.120
120 mm / 4 3/4"



BD.370.150
150 mm / 6"



Iris
100 mm / 4"



BD.350.100



BD.351.100



BD.352.100



Semken



BD.394.125
125 mm / 5"



BD.395.125
125 mm / 5"

BD.394.150
150 mm / 6"

BD.395.150
150 mm / 6"



Gerald
175 mm / 6"



BD.380.175













BD.381.175



Gillies
BD.400.150
150 mm / 6"



Dissecting forceps / Pensety anatomiczne

 <p>BD.424.180 180 mm / 7" BD.424.210 210 mm / 8 1/4" BD.424.250 250 mm / 9"</p>	 <p>BD.425.180 180 mm / 7" BD.425.210 210 mm / 8 1/4" BD.425.250 250 mm / 9"</p>	 <p>BD.500.105 105 mm BD.500.115 115 mm BD.500.130 130 mm BD.500.145 145 mm BD.500.150 150 mm BD.500.160 160 mm BD.500.180 180 mm BD.500.200 200 mm BD.500.230 230 mm BD.500.250 250 mm BD.500.305 305 mm BD.500.405 405 mm BD.500.505 505 mm</p>	 <p>BD.502.105 105 mm BD.502.115 115 mm BD.502.130 130 mm BD.502.145 145 mm BD.502.160 160 mm BD.502.180 180 mm BD.502.200 200 mm BD.502.230 230 mm BD.502.250 250 mm</p>	 <p>BD.504.130 130 mm BD.504.145 145 mm BD.504.160 160 mm</p>
<p>Potts-Smith</p>	<p>Potts-Smith</p>	<p>Falcon - Standard</p>	<p>Falcon - Medium</p>	<p>Falcon - Fine</p>
 <p>BD.510.120 120 mm / 4 3/4" BD.510.130 130 mm / 5" BD.510.145 145 mm / 5 3/4" BD.510.155 155 mm / 6" BD.510.180 180 mm / 7" BD.510.210 210 mm / 8 1/4" BD.510.250 250 mm / 9"</p>	 <p>BD.520.130 130 mm / 5" BD.520.150 150 mm / 6" BD.520.180 180 mm / 7" BD.520.200 200 mm / 8" BD.520.255 255 mm / 10" BD.520.305 305 mm / 12"</p>	 <p>BD.524.130 130 mm / 5" BD.524.150 150 mm / 6" BD.524.180 180 mm / 7" BD.524.200 200 mm / 8"</p>	 <p>BD.530.130 130 mm / 5" BD.530.150 150 mm / 6" BD.530.180 180 mm / 7" BD.530.200 200 mm / 8"</p>	 <p>BD.540.140 140 mm / 5 1/2" BD.540.180 180 mm / 7"</p>
<p>Standard (USA Pattern)</p>	<p>Standard (English Pattern)</p>	<p>TOE (English Pattern)</p>	<p>Stille - Leeds (Swedish Pattern)</p>	<p>Lane BD.540.140 140 mm / 5 1/2" BD.540.180 180 mm / 7"</p>

Tissue forceps / Pensety chirurgiczne

Titanium
Tytanowe

Falcon
GRIP

Forceps with tungsten carbide inserts
Pensety z wkładką z węgla spiekanego



Adson
120 mm / 4 3/4"



BD.104.120



Greafe
110 mm



BD.603.110



BD.604.110



Bishop-Harmon
BD.1502.90
90 mm

1 x 2 th



Adson
120 mm



BD.250.120



Adson-Brown
120 mm



BD.626.120



Iris
100 mm / 4"



BD.600.100



BD.601.100



BD.602.100



Adson-Micro



BD.610.120
120 mm / 4 3/4"



BD.610.150
150 mm / 6"



Adson



BD.620.120
120 mm / 4 3/4"











BD.620.150
150 mm / 6"









Gillies
BD.650.150
150 mm / 6"



Tissue forceps / Pensety chirurgiczne

							
	BD.644.125 125 mm / 5"	BD.645.125 125 mm / 5"	BD.630.175				
	BD.644.150 150 mm / 6"	BD.645.150 150 mm / 6"				BD.750.115 115 mm	BD.752.130 130 mm
						BD.750.130 130 mm	BD.752.145 145 mm
						BD.750.145 145 mm	BD.752.160 160 mm
						BD.750.150 150 mm	BD.752.180 180 mm
						BD.750.160 160 mm	BD.752.200 200 mm
						BD.750.180 180 mm	
						BD.750.200 200 mm	
						BD.750.230 230 mm	
						BD.750.250 250 mm	
						BD.750.305 305 mm	
Semken				Gerald 175 mm / 6		Falcon - Standard	Falcon - Medium

							
	BD.754.130 130 mm		BD.756.130 130 mm				BD.758.130 130 mm
	BD.754.145 145 mm	BD.756.145 145 mm	BD.758.145 145 mm	BD.760.145 145 mm	BD.770.150 150 mm		
	BD.754.160 160 mm	BD.756.160 160 mm	BD.758.160 160 mm	BD.760.160 160 mm	BD.770.180 180 mm		
					BD.770.200 200 mm		
Falcon - Fine		Falcon - Standard		Falcon - Standard		Falcon - Standard	Treves (English Pattern)

Tissue forceps / Pensety chirurgiczne

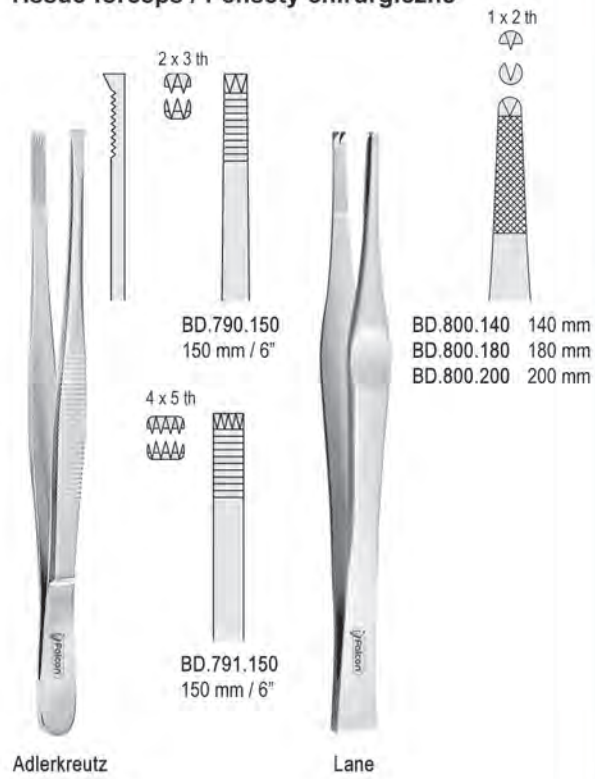

Watchmaker forceps / Pensety Watchmaker

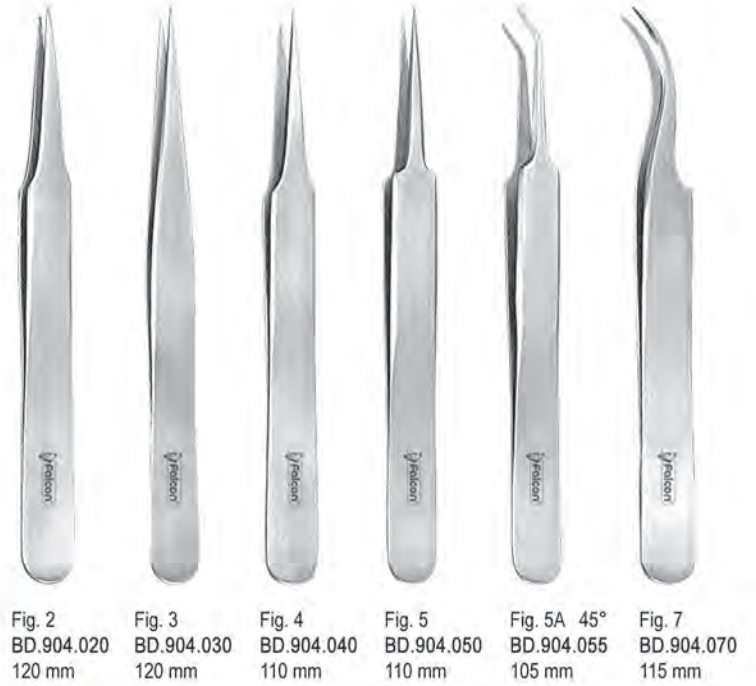

Splinter forceps / Kleszczyki do usuwania odłamków

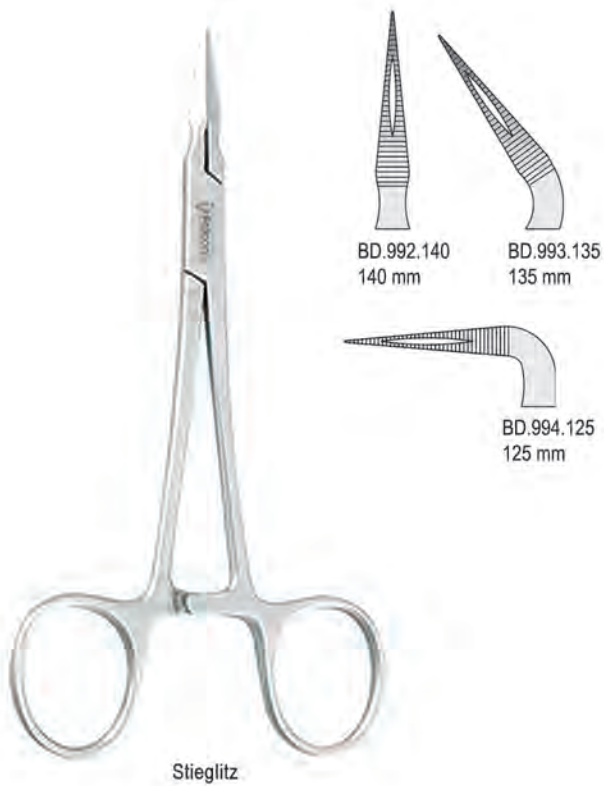

Splinter forceps / Pensety do odłamków

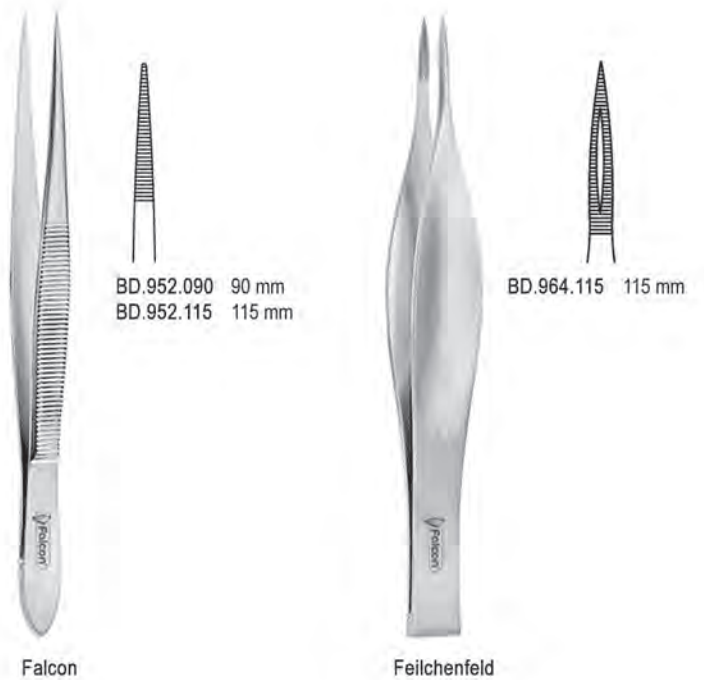

Towel forceps / Spinaki do serwet



Backhaus
BF.431.090 90mm
BF.431.110 110mm
BF.431.130 110mm
BF.431.150 150mm



Devon (Ball and Socket)
BF.511.095 95mm
BF.511.105 105mm
BF.511.115 115mm
BF.511.130 130mm
BF.511.140 140mm



Jones
BF.407.090
90 mm



Schaedel
BF.411.090
90 mm

Haemostatic forceps / Kleszczyki naczyniowe

Titanium
Tytanowe



Micro Mosquito

BH.220.125T 125 mm
BH.221.125T 125 mm



Hartmann (Baby Mosquito)

BH.210.100T 100 mm
BH.211.100T 100 mm



Jacobson

BH.208.125 125 mm / 5"
BH.209.125 125 mm / 5"

Haemostatic forceps / Kleszczyki naczyniowe

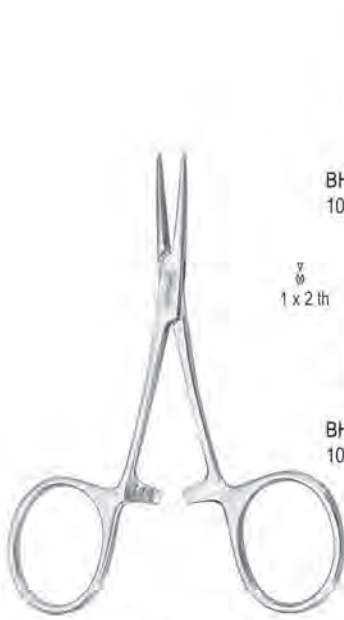

Hartmann (Baby Mosquito)

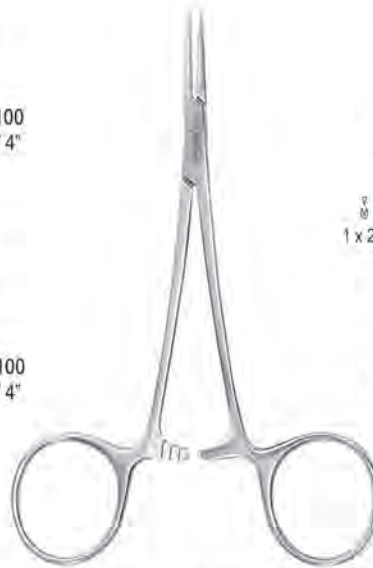
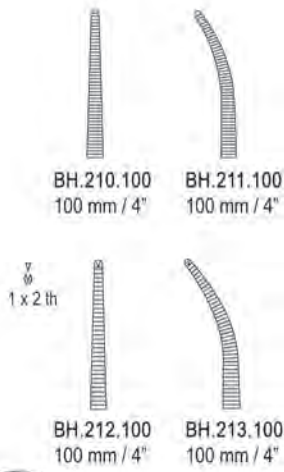

Micro Halsted-Mosquito

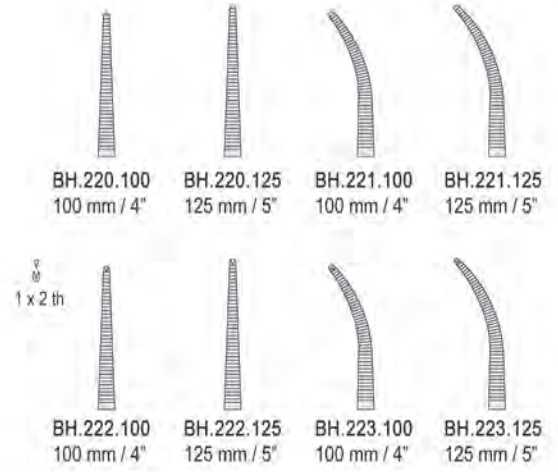

Halsted-Mosquito

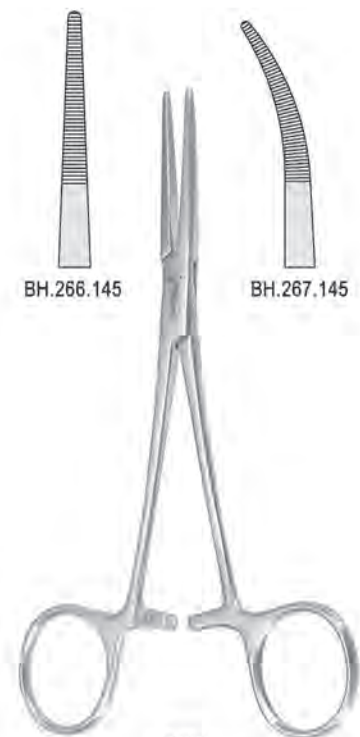
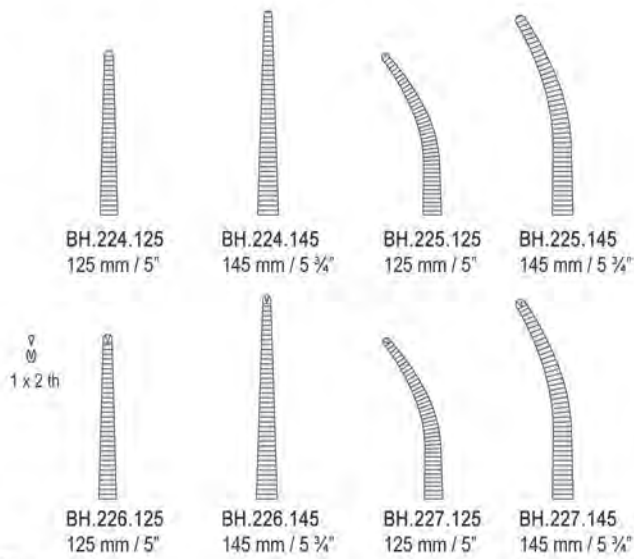

Kelly
145 mm / 5 3/4"

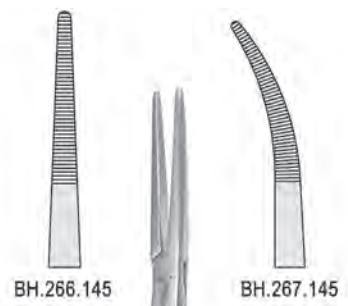

Haemostatic forceps / Kleszczyki naczyniowe

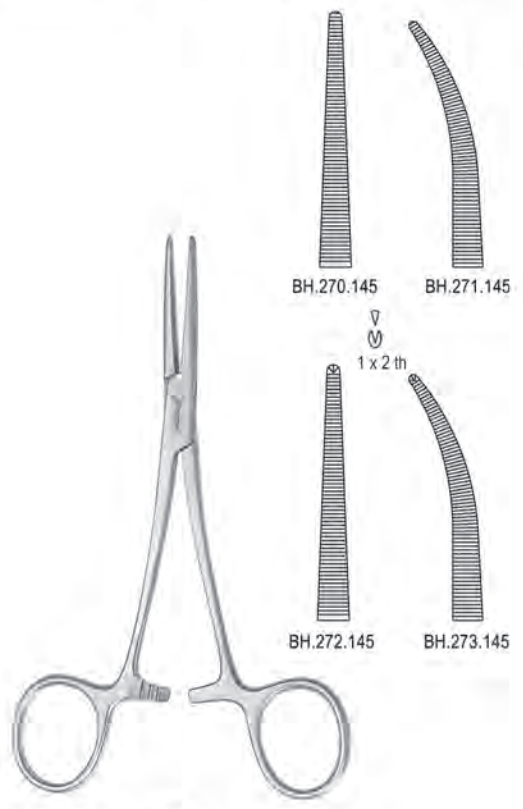

Crile
145 mm / 5 3/4"

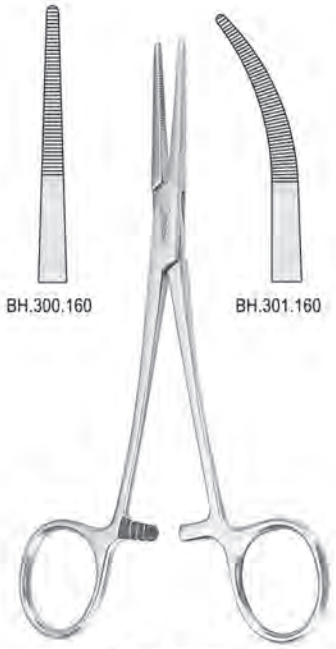

Kelly-Rankin
160 mm / 6 1/4"

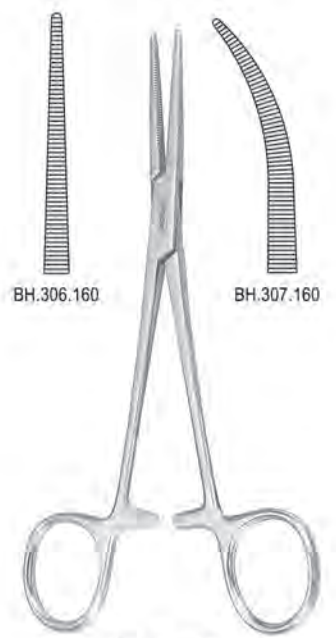

Crile-Rankin
160 mm / 6 1/4"

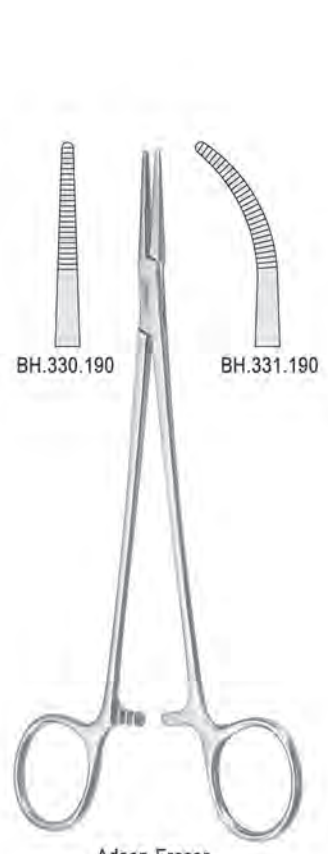

Adson-Fraser
190mm

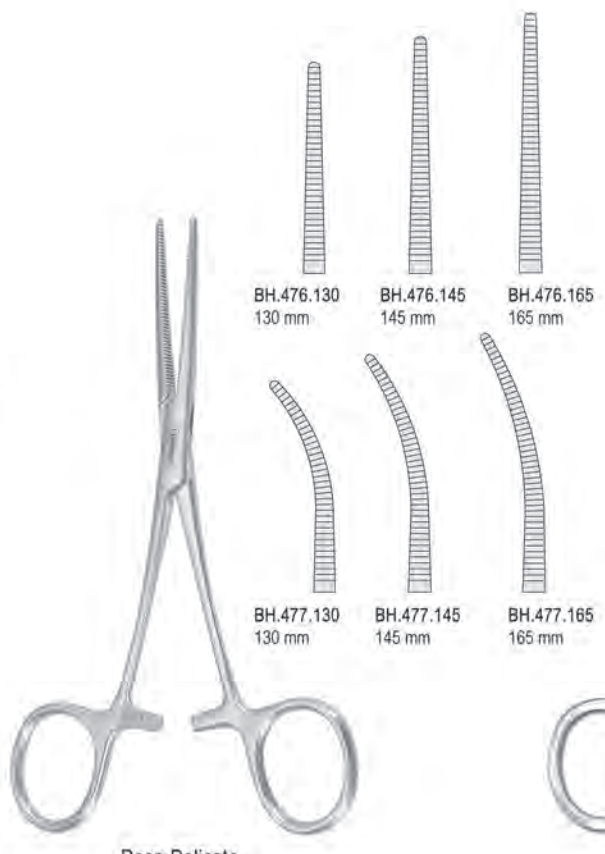

Pean-Delicate

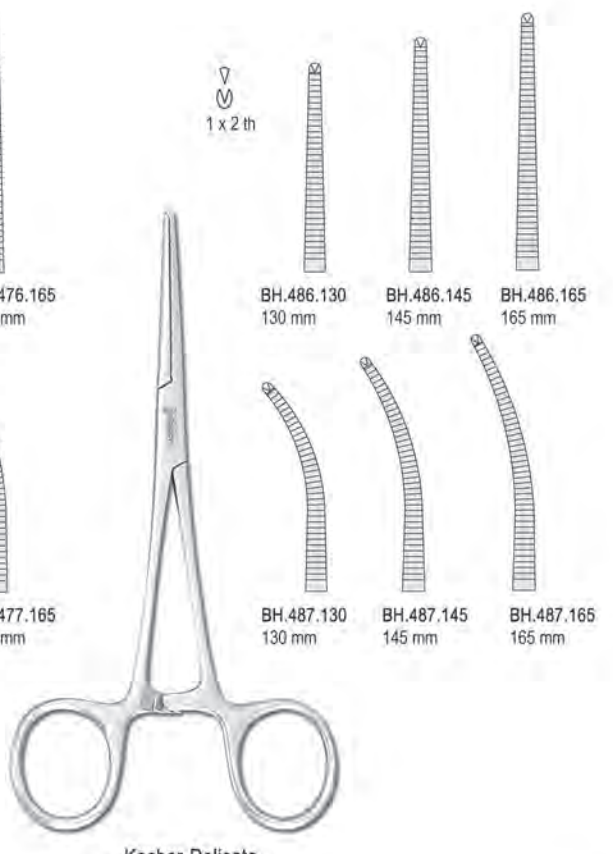

Kocher-Delicate

Haemostatic forceps / Kleszcyki naczyniowe



Rochester-Pean

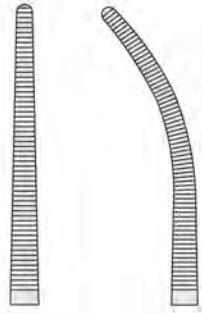

Code / Kod	Type / Typ	Size / Długość
BH.480.130	straight / proste	130 mm
BH.480.145	straight / proste	145 mm
BH.480.165	straight / proste	165 mm
BH.480.185	straight / proste	185 mm
BH.480.205	straight / proste	205 mm
BH.480.225	straight / proste	225 mm
BH.480.245	straight / proste	245 mm
BH.481.130	curved / zagięte	130 mm
BH.481.145	curved / zagięte	145 mm
BH.481.165	curved / zagięte	165 mm
BH.481.185	curved / zagięte	185 mm
BH.481.205	curved / zagięte	205 mm
BH.481.225	curved / zagięte	225 mm
BH.481.245	curved / zagięte	245 mm



Kocher

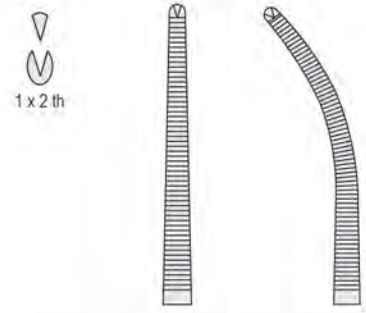

Code / Kod	Type / Typ	Size / Długość
BH.490.130	straight / proste	130 mm
BH.490.145	straight / proste	145 mm
BH.490.165	straight / proste	165 mm
BH.490.185	straight / proste	185 mm
BH.490.205	straight / proste	205 mm
BH.490.225	straight / proste	225 mm
BH.490.245	straight / proste	245 mm
BH.491.130	curved / zagięte	130 mm
BH.491.145	curved / zagięte	145 mm
BH.491.165	curved / zagięte	165 mm
BH.491.185	curved / zagięte	185 mm
BH.491.205	curved / zagięte	205 mm
BH.491.225	curved / zagięte	225 mm
BH.491.245	curved / zagięte	245 mm

Dressing and sponge forceps / Kleszce do materiałów opatrunkowych



BF.056.200
200mm
BF.056.250
250mm



BF.057.200
200mm
BF.057.250
250mm



BF.046.200
200mm
BF.046.250
250mm



BF.047.200
200mm
BF.047.250
250mm



Foerster

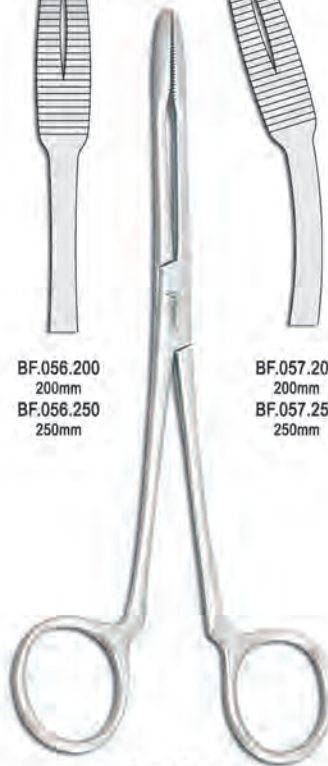

Gross-Maier

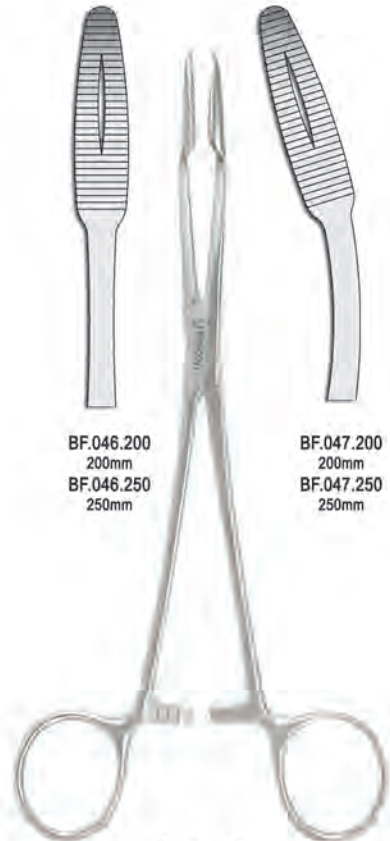

Gross-Maier

Needle holders with tungsten carbide inserts / Igotrzymacze z wkładką z węglika spiekanego

Tungsten Carbide inserts are available in smooth or choice of 3 different serration pitches, for use with different size of suture needles as shown in chart below.

Końcówki Igotrzymacze Falcon Grip z wkładką z węglika spiekanego są dostępne z gładką powierzchnią lub w 3 różnych typach radełkowania, umożliwiających użycie różnych rozmiarów igieł. (patrz tabela).



**3 lata
Gwarancji**









Castroviejo
140 mm / 5 1/2"

**3 Years
Guarantee**



Castroviejo
180 mm / 7"

<p>0.2 Micro</p>  <p>BN.152.140 Suture / Nici 6/0 to/do 10/0</p> <p>Smooth / Gładka</p>  <p>BN.150.140 Suture / Nici 9/0 to/do 11/0</p>	<p>0.2 Micro</p>  <p>BN.153.140 Suture / Nici 6/0 to/do 10/0</p> <p>Smooth / Gładka</p>  <p>BN.151.140 Suture / Nici 9/0 to/do 11/0</p>
<p>0.2 Micro</p>  <p>BN.154.140 Suture / Nici 6/0 to/do 10/0</p>	<p>0.2 Micro</p>  <p>BN.155.140 Suture / Nici 6/0 to/do 10/0</p>

	Serration Pitch Powierzchnia końcówek	Suture Size Rozmiar nici
	Smooth / Gładka	9/0 to/do 11/0
	0.2 Micro / Mikro	6/0 to/do 10/0
	0.4 Fine / Fine	4/0 to/do 6/0
	0.5 Standard / Standard	Up to/do 3/0

Falcon Grip needle holders offer secure grip thus safe guiding of needle. Igotrzymacze Falcon Grip posiadają uchwyt, umożliwiający bezpieczne prowadzenie igły.

0.2 Micro



BN.157.140
Suture / Nici
6/0 to/do 10/0

Smooth / Gładka



BN.156.140
Suture / Nici
9/0 to/do 11/0

0.2 Micro



BN.158.140
Suture / Nici
6/0 to/do 10/0

Castroviejo
140 mm / 5 1/2"

0.2 Micro



BN.152.180
Suture / Nici
6/0 to/do 10/0

Titanium needle holders
Igłotrzymacze tytanowe

Needle holders with tungsten carbide inserts
Igłotrzymacze z wkładką z węgla spiekanego



3 Years
Guarantee

3 lata
Gwarancji

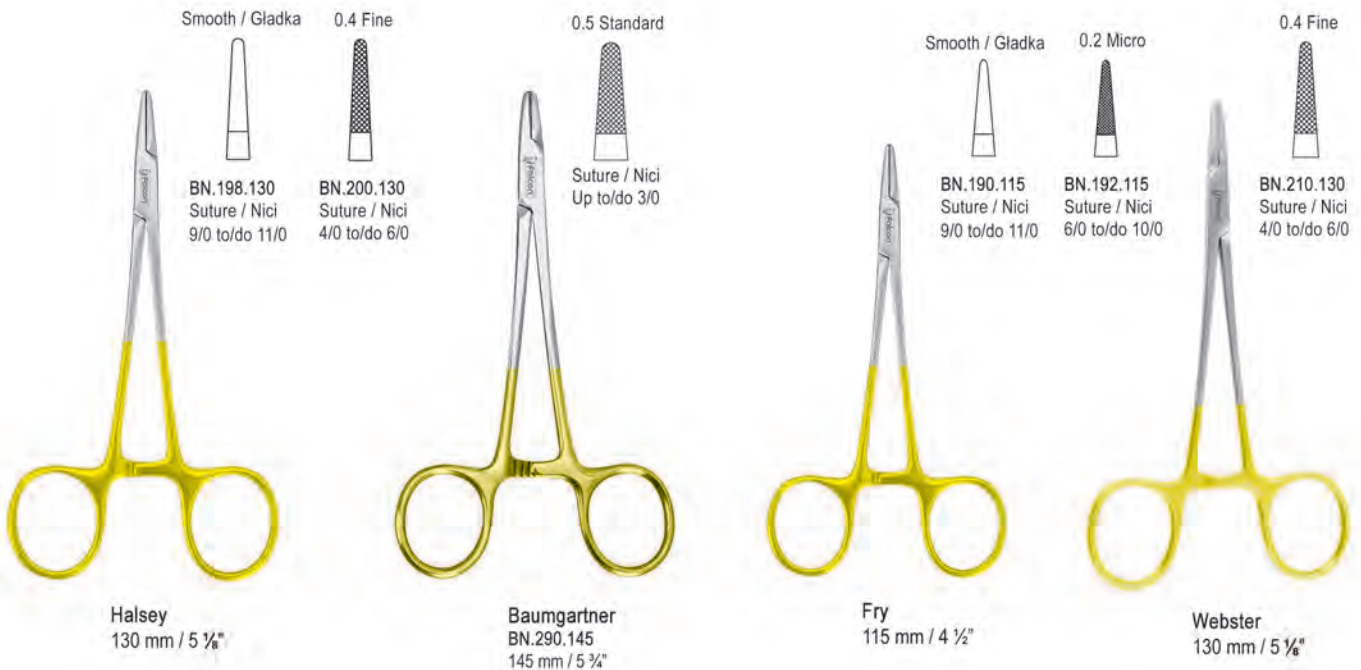
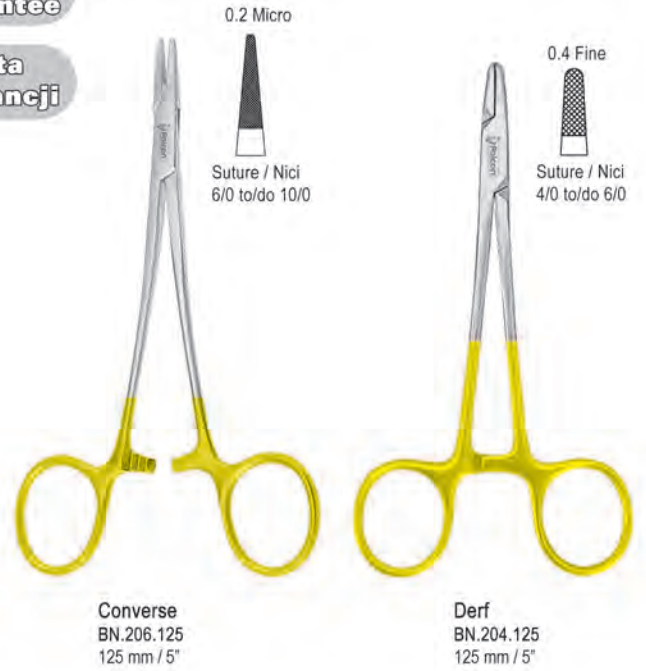



Needle holders with tungsten carbide inserts
Igłotrzymacze z wkładką z węgla spiekanego

3 Years
Guarantee

3 lata
Gwarancji

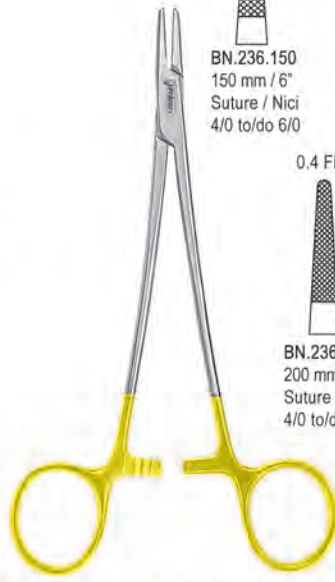

 <p>0.4 Fine</p> <p>BN.235.150 150 mm / 6" Suture / Nici 4/0 to/do 6/0</p>	 <p>0.4 Fine</p> <p>BN.236.150 150 mm / 6" Suture / Nici 4/0 to/do 6/0</p> <p>0.4 Fine</p> <p>BN.236.180 180 mm / 7" Suture / Nici 4/0 to/do 6/0</p> <p>0.4 Fine</p> <p>BN.236.200 200 mm / 8" Suture / Nici 4/0 to/do 6/0</p>	 <p>0.4 Fine</p> <p>BN.237.150 150 mm / 6" Suture / Nici 4/0 to/do 6/0</p>	 <p>0.4 Fine</p> <p>BN.238.150 150 mm / 6" Suture / Nici 4/0 to/do 6/0</p>
Crile-Wood	Crile-Wood	Crile-Wood S-Shape	Baby-Crile-Wood

 <p>0.4 Fine</p> <p>BN.230.150 150 mm Suture / Nici 4/0 to/do 6/0</p>	 <p>0.2 Micro</p> <p>BN.242.140 140 mm Suture / Nici 6/0 to/do 10/0</p> <p>0.2 Micro</p> <p>BN.242.180 180 mm Suture / Nici 6/0 to/do 10/0</p>	 <table border="0"> <tr> <td data-bbox="1023 1372 1128 1644"> <p>0.5 Standard</p>  <p>BN.298.130 130 mm / 5 Suture / Nici Up to/do 3/0</p> </td> <td data-bbox="1161 1372 1266 1644"> <p>0.5 Standard</p>  <p>BN.298.140 140 mm Suture / Nici Up to/do 3/0</p> </td> <td data-bbox="1299 1372 1404 1644"> <p>0.5 Standard</p>  <p>BN.298.150 150 mm Suture / Nici Up to/do 3/0</p> </td> <td data-bbox="1445 1372 1550 1644"> <p>0.5 Standard</p>  <p>BN.298.160 160 mm Suture / Nici Up to/do 3/0</p> </td> </tr> <tr> <td data-bbox="1023 1655 1128 1973"> <p>0.5 Standard</p>  <p>BN.298.180 180 mm Suture / Nici Up to/do 3/0</p> </td> <td data-bbox="1161 1655 1266 1973"> <p>0.5 Standard</p>  <p>BN.298.190 190 mm Suture / Nici Up to/do 3/0</p> </td> <td data-bbox="1299 1655 1404 1973"> <p>0.5 Standard</p>  <p>BN.298.200 200 mm Suture / Nici Up to/do 3/0</p> </td> <td></td> </tr> </table>				<p>0.5 Standard</p>  <p>BN.298.130 130 mm / 5 Suture / Nici Up to/do 3/0</p>	<p>0.5 Standard</p>  <p>BN.298.140 140 mm Suture / Nici Up to/do 3/0</p>	<p>0.5 Standard</p>  <p>BN.298.150 150 mm Suture / Nici Up to/do 3/0</p>	<p>0.5 Standard</p>  <p>BN.298.160 160 mm Suture / Nici Up to/do 3/0</p>	<p>0.5 Standard</p>  <p>BN.298.180 180 mm Suture / Nici Up to/do 3/0</p>	<p>0.5 Standard</p>  <p>BN.298.190 190 mm Suture / Nici Up to/do 3/0</p>	<p>0.5 Standard</p>  <p>BN.298.200 200 mm Suture / Nici Up to/do 3/0</p>	
<p>0.5 Standard</p>  <p>BN.298.130 130 mm / 5 Suture / Nici Up to/do 3/0</p>	<p>0.5 Standard</p>  <p>BN.298.140 140 mm Suture / Nici Up to/do 3/0</p>	<p>0.5 Standard</p>  <p>BN.298.150 150 mm Suture / Nici Up to/do 3/0</p>	<p>0.5 Standard</p>  <p>BN.298.160 160 mm Suture / Nici Up to/do 3/0</p>										
<p>0.5 Standard</p>  <p>BN.298.180 180 mm Suture / Nici Up to/do 3/0</p>	<p>0.5 Standard</p>  <p>BN.298.190 190 mm Suture / Nici Up to/do 3/0</p>	<p>0.5 Standard</p>  <p>BN.298.200 200 mm Suture / Nici Up to/do 3/0</p>											
Swedish Pattern (Senning)	Falcon - Micro Vascular	Mayo-Hegar											

Needle holders with tungsten carbide inserts
Igotrzymacze z wkładką z węglika spiekane



3 Years
Guarantee

3 lata
Gwarancji

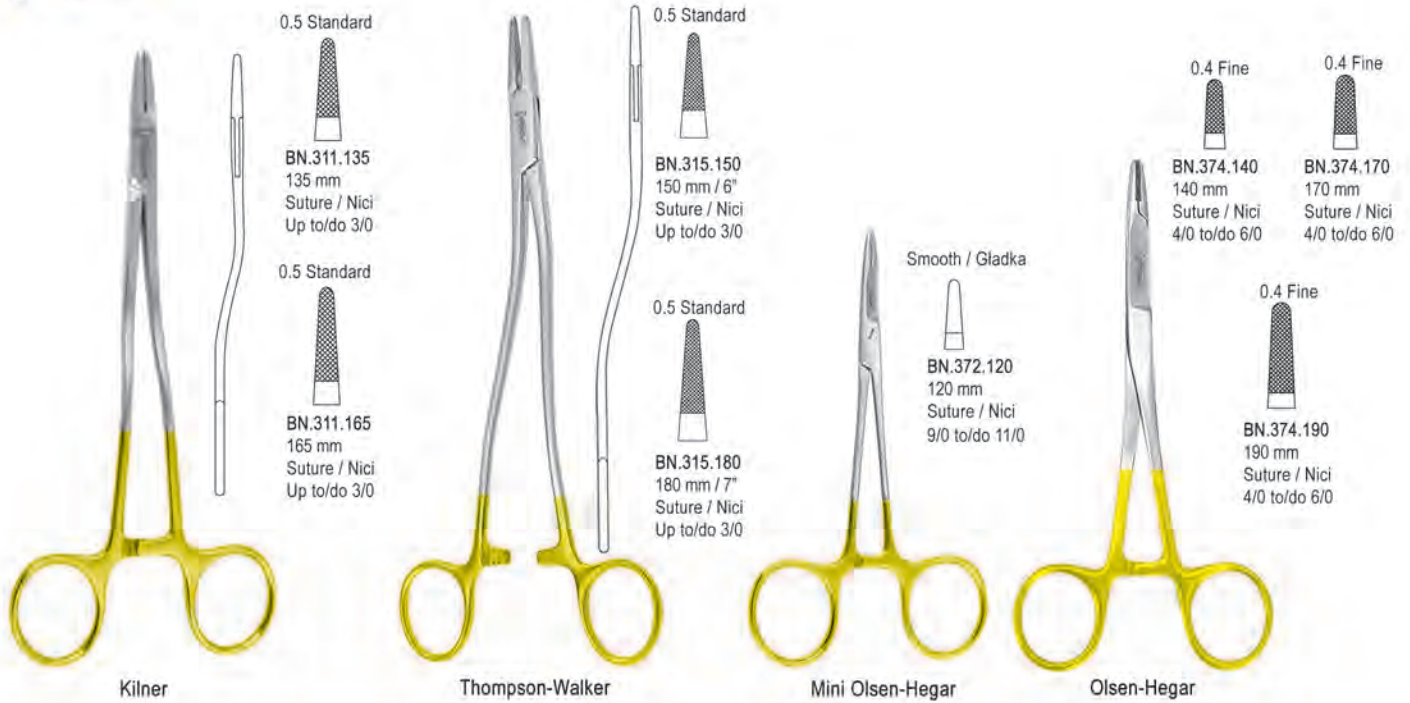

Kilner

Thompson-Walker

Mini Olsen-Hegar

Olsen-Hegar

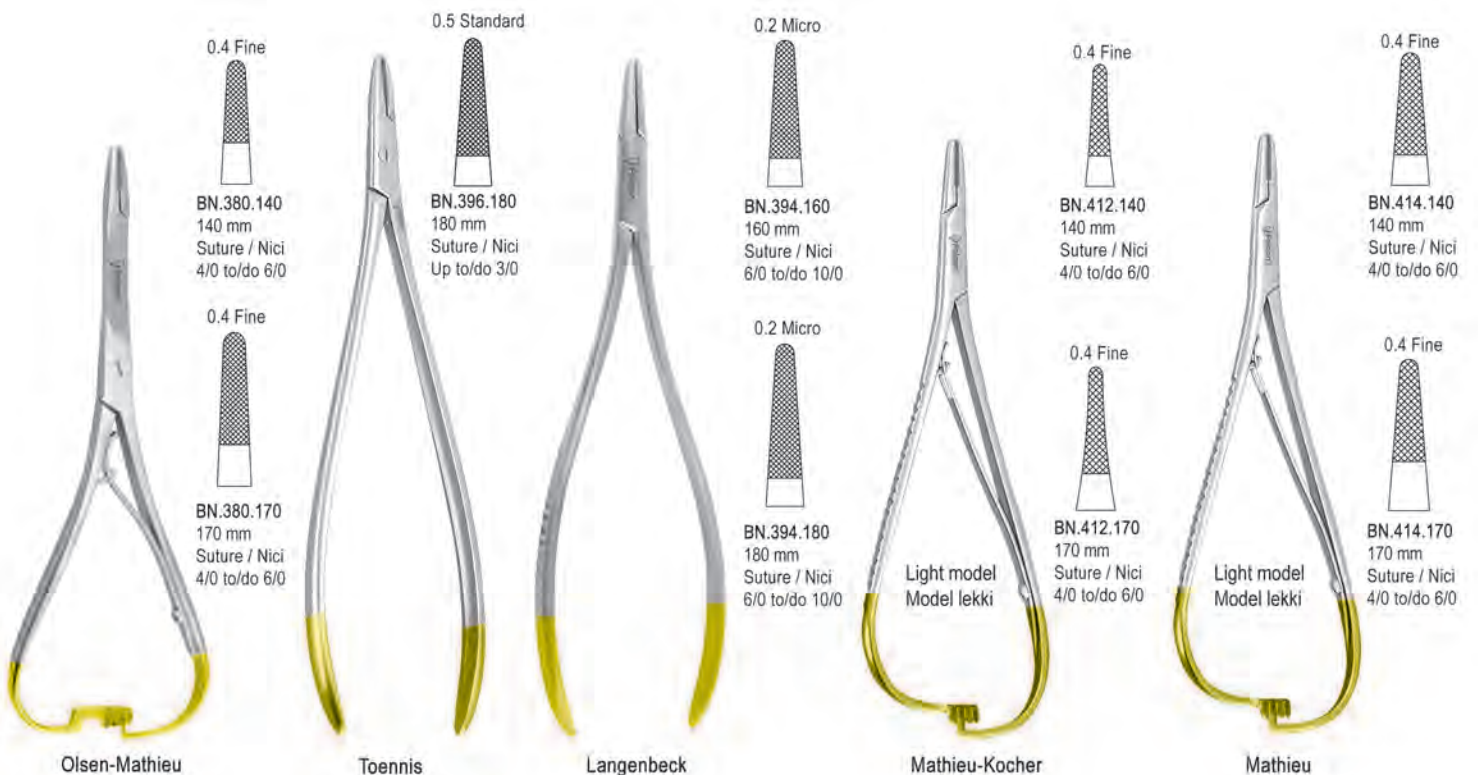

Olsen-Mathieu

Toennis

Langenbeck

Mathieu-Kocher

Mathieu

Needle holders with tungsten carbide inserts
Igiotrzymacze z wkładką z węgla spiekanego

3 Years
Guarantee

3 lata
Gwarancji

Falcon[®] with tungsten carbide inserts
z wkładką z węgla spiekanego



Mathieu
Standard model
Model standardowy

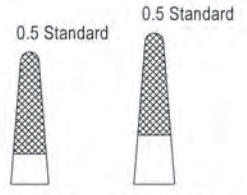

BN.416.140
140 mm
Suture / Nici
Up to/do 3/0

BN.416.170
170 mm
Suture / Nici
Up to/do 3/0

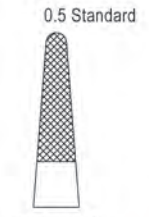

BN.416.200
200 mm
Suture / Nici
Up to/do 3/0



Mathieu
Reverse action, snag free
Uchwyt nie zaczepla rękawiczek

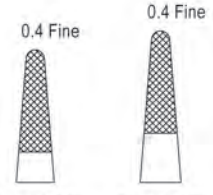

BN.418.140
140 mm
Suture / Nici
4/0 to/do 6/0

BN.418.170
170 mm
Suture / Nici
4/0 to/do 6/0



Metzenbaum



BN.431.140
140 mm
Suture / Nici
4/0 to/do 6/0

BN.431.170
170 mm
Suture / Nici
4/0 to/do 6/0

Needle holders
Igiotrzymacze



Castroviejo
140 mm



Castroviejo
140 mm



BN.457.140
Castroviejo
140 mm



BN.458.140
Castroviejo
140 mm



BN.506.125
Derf
125 mm

Needle holders
Igłotrzymacze

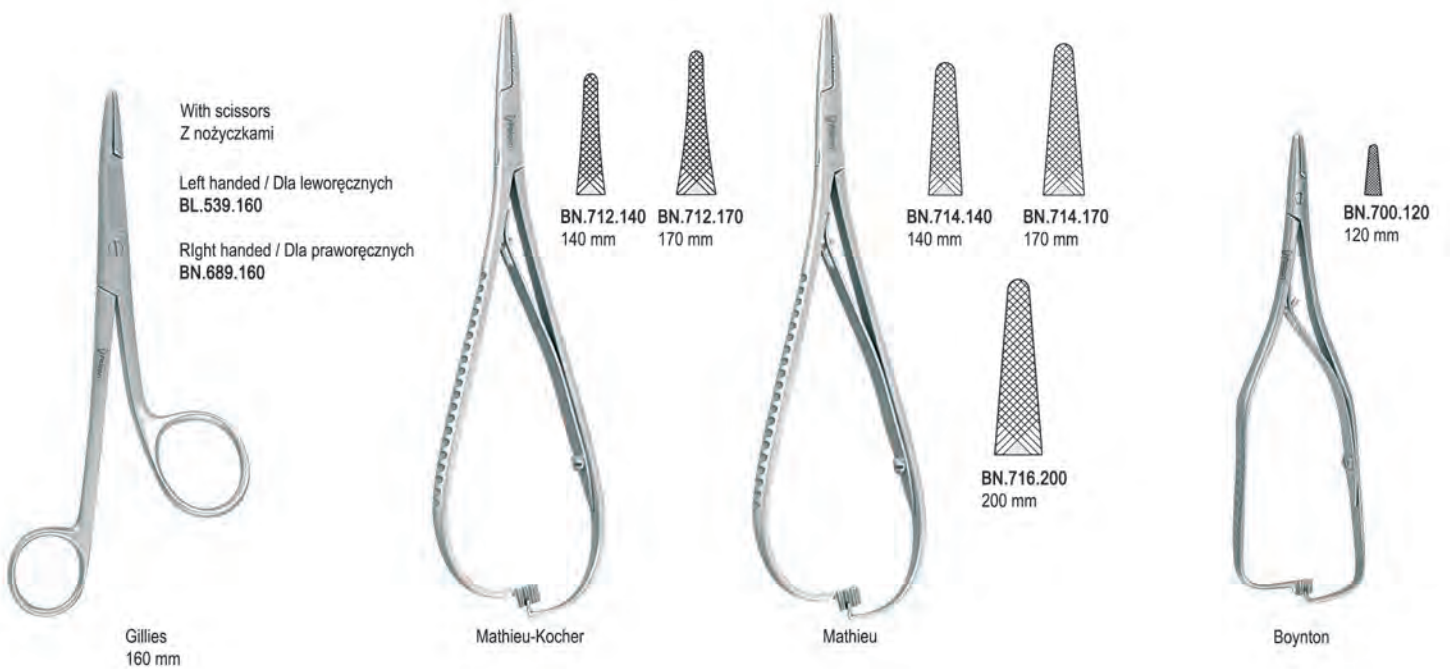

Novosyn® absorbable surgical sutures / Nici chirurgiczne wchłaniające Novosyn®

Novosyn®

Absorbable sutures



Description

Novosyn® is a mid-term absorbable braided and coated synthetic suture made of poly (glycolide-co-l-lactid 90/10).

Novosyn® degrades by hydrolysis and provides a predictable and reliable absorption.

Properties

- Retention of 40 % - 50 % knot tensile strength after 21 days
- Complete mass absorption in 56 to 70 days

Indications

- Gastrointestinal surgery
- Gynaecology / Obstetrics
- Orthopaedics
- Ophthalmic surgery
- Urology
- Skin closure (intracutaneous, subcutaneous)
- Ligatures



Advantages

- Smooth knot run-down
- Gentle knot repositioning
- High knot holding capacity
- Minimized inflammatory reaction

Novosyn®

Product overview





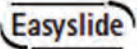





Structure	Multifilament, braided
Colour	Violet or undyed
Chemical composition	Poly(glycolide-co-l-lactid 90 / 10)
Coating	Poly(glycolide-co-l-lactid 35 / 65) + calcium stearate
Origen	Synthetic
Sizes	USP 2 (metric 5) - USP 8 / 0 (metric 0.4)
Type of absorption	Hydrolysis, complete mass absorption in 56 to 70 days
Sterilisation	Ethylene oxide

Novosyn®

Needle-thread combination 

Novosyn® absorbable surgical sutures / Nici chirurgiczne wchłanialne Novosyn®

Pack of 36 pieces / Opak. 36 szt.

Needle length mm	Thread length cm colour	USP metric								
		6/0 0.7	5/0 1	4/0 1.5	3/0 2	2/0 3	0 3.5	1 4	2 5	
1/2 circle round bodied needle										
HR 10 	70 violet	C0068002	C0068003							
HR 13 	45 70 violet	C0068449 C0068006	C0068450 C0068007	C0068451 C0068008						
HR 13 	4x45 violet *take off			C0088719						
HR 13ss 	70 violet					C0068110	C0068111			
HR 17 	70 violet	C0068011	C0068012	C0068013	C0068014	C0068015				
HR 17 	4x45 4x70 violet *take off			C0088713 C0088613	C0088714 C0088614					
2xHR 17 	70 90 violet		C0068869		C0068904					
HR 17s 	70 violet			C0068113	C0068114					
HR 20 	70 violet				C0068766					
HR 22 	20 70 violet			C0068029	C0068069 C0068030	C0068004 C0068031	C0068032			
	90 120 violet				C0068877 C0068078	C0068880				

Dafilon non-absorbable nylon monofilament suture / Nici chirurgiczne Dafilon niewchłaniałne













Product features

Structure	Monofilament
Chemical composition	Polyamide 6 and 6.6
Colour	Blue, undyed and black
Sizes	USP 1 (metric 4) to USP 11/0 (metric 0,1)
Knot tensile strength retention	15–20% per year
Indications	Skin and Plastic surgery, Micro-vascular surgery, Ophthalmology, Orthopaedics
Contraindications	Not known
Sterilisation	Gamma-Irradiation, Ethylene oxide

Dafilon non-absorbable nylon monofilament suture / Nici chirurgiczne Dafilon niewchłaniałne

Pack of 36 pieces / Opak. 36 szt.

 Needle-thread combination **Easyslide**

Needle length mm	Thread length cm colour	USP metric								
		6/0 0.7	5/0 1	4/0 1.5	3/0 2	2/0 3	0 3.5	1 4	2 5	
1/2 proc. reverse pulling needle										
 HS 21	90 blue			C0932876	C0932884					
 HS 26	75 90 blue					C0932957	C0934968	C0935964		
 HS 30	75 90 blue				C0934003	C0934011			C0935034	
 HS 37	90 blue					C0934054				
 HS 48	75 blue								C0932620	
1/8 proc. reverse pulling needle										
 DS 12	45 blue	C0932060	C0932078	C0932086						
 DS 16	45 75 blue	C0932116	C0932124	C0932132	C0932140					
			C0935123	C0935131	C0935107					
 DS 19	45 75 blue		C0932191	C0932205	C0932213	C0932221				
			C0935190	C0935204	C0935212					
 DS 19	90 blue		C0935255	C0935220	C0935239	C0935247				
 DS 24	45 75 blue			C0932345	C0932353	C0932361				
				C0935344	C0935352	C0935360	C0935379			
 DS 24	90 blue				C0935328	C0935336				

Hooks / Haczyki



Gillies
180 mm / 7"



Fig. 1
BQ.041.010



Fig. 2
BQ.041.020



Kilner
BQ.045.160
150 mm / 6"



Kleinert-Kutz
160 mm / 6 1/4"



Fig. 1
BQ.049.010



Fig. 2
BQ.049.020

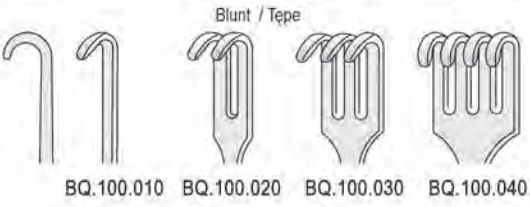
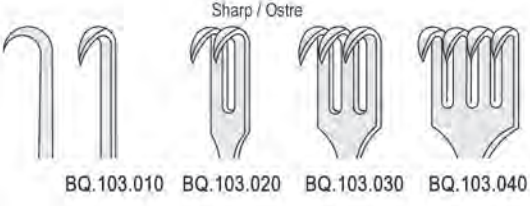

Fig. 3
BQ.049.030

Retractors / Haki



Falcon
160 mm / 6 1/4"



Senn-Miller
160 mm

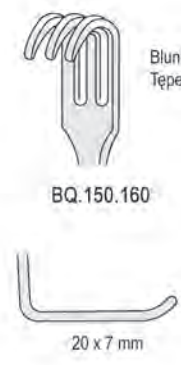
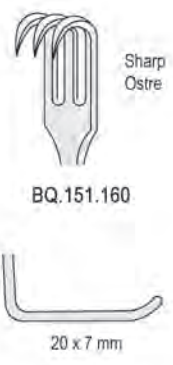

Ragnell-Davis
BQ.180.020
140 mm / 5 1/2"



Retractors / Haki



Fig. 2 = 30 x 10 mm
Fig. 1 = 26 x 10 mm

Fig. 1 = 30 x 13 mm
Fig. 2 = 34 x 13 mm

Farabeuf
BQ.250.120
120 mm / 4 3/4"
Pair / Paio / Para



Fig. 2 = 27 x 16 mm
Fig. 1 = 23 x 16 mm

Fig. 1 = 26 x 16 mm
Fig. 2 = 30 x 16 mm

Farabeuf
BQ.250.150
150 mm / 6"
Pair / Paio / Para



Fig. 2 = 25 x 15 mm
Fig. 1 = 21 x 15 mm

Fig. 1 = 40 x 15 mm
Fig. 2 = 45 x 15 mm

Parker-Langenbeck
BQ.284.210
210 mm / 8 1/4"
Pair / Paio / Para



Langenbeck
220 mm / 8 3/4"



BQ.454.010
30 x 11 mm



BQ.454.020
30 x 14 mm

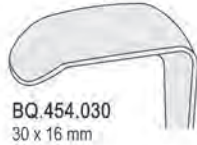

BQ.454.030
30 x 16 mm



BQ.454.040
40 x 11 mm



BQ.454.050
50 x 11 mm



Langenbeck
220 mm / 8 3/4"



BQ.458.010
30 x 11 mm

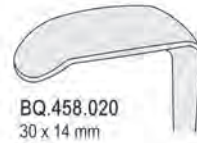

BQ.458.020
30 x 14 mm



BQ.458.030
30 x 16 mm



BQ.458.040
40 x 11 mm



BQ.458.050
50 x 11 mm

Retractors / Haki



Kocher-Langenbeck
215 mm / 8 1/2"



Middeldorp

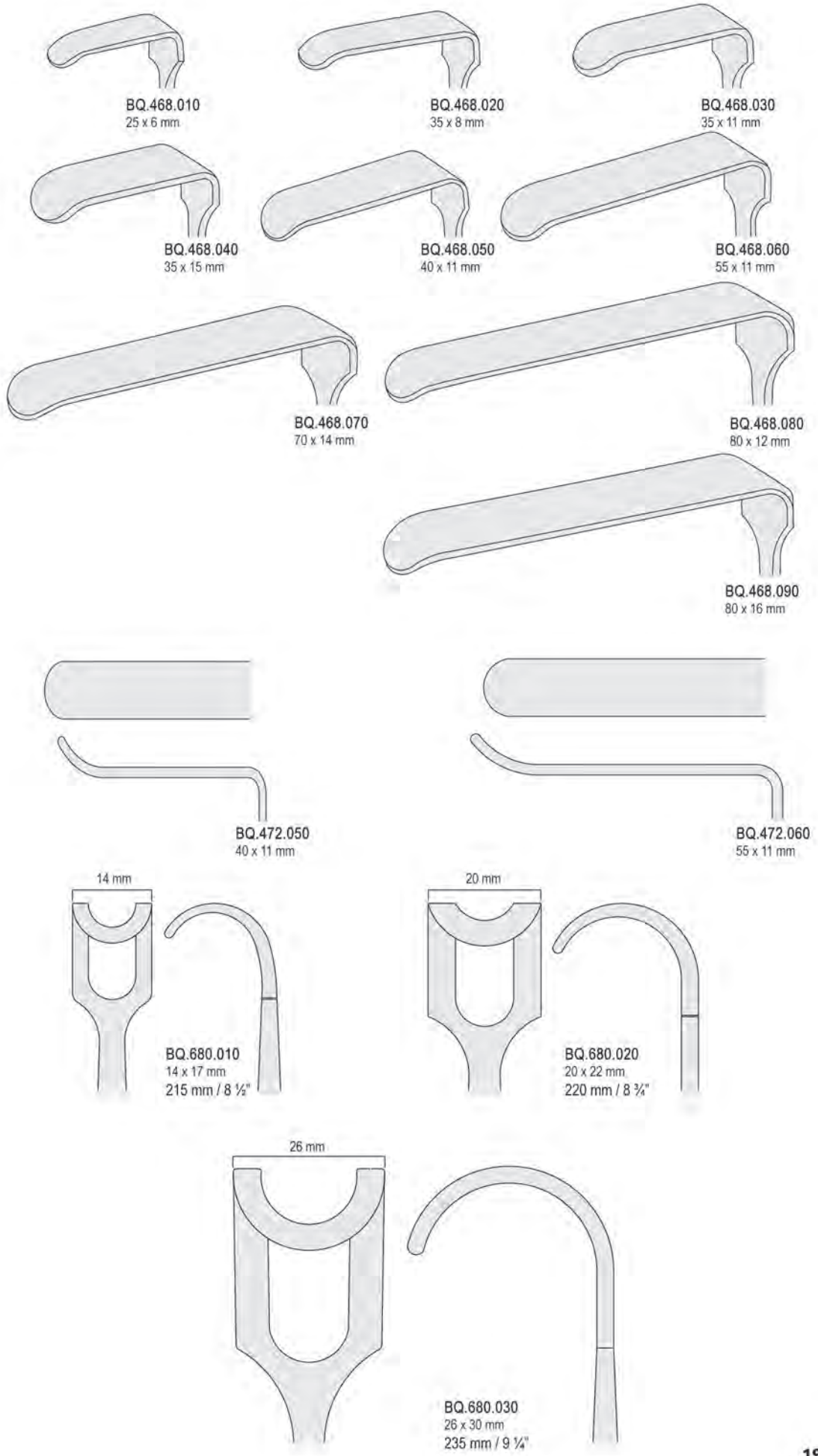

Retractors self retaining / Haki automatyczne



Weitlaner		
BR.077.135	Sharp / Ostry	∧
BR.074.135	Blunt / Tępy	∩
135 mm / 5 3/8"		
BR.077.165	Sharp / Ostry	∧
BR.074.165	Blunt / Tępy	∩
165 mm / 6 1/2"		



Gelpi		
BR.351.090	Sharp / Ostry	90 mm
BR.351.110	Sharp / Ostry	110 mm
BR.351.145	Sharp / Ostry	140 mm
BR.351.180	Sharp / Ostry	180 mm



Weitlaner		
BR.073.110	Sharp / Ostry	∧
BR.070.110	Blunt / Tępy	∩
110 mm / 4 3/8"		



Alm		
BR.041.070	Sharp / Ostry	∧
BR.040.070	Blunt / Tępy	∩
70 mm / 2 3/4"		
BR.041.100	Sharp / Ostry	∧
BR.040.100	Blunt / Tępy	∩
100 mm / 4"		

Probes / Zgłębniki główkowe

Ø 1 mm	Product Code	Length
-----	BP.050.115	115 mm
	BP.050.130	130 mm
	BP.050.145	145 mm
	BP.050.160	160 mm
	BP.050.180	180 mm
BP.050.200	200 mm	

Ø 2 mm	Product Code	Length
-----	BP.055.115	115 mm
	BP.055.130	130 mm
	BP.055.145	145 mm
	BP.055.160	160 mm
	BP.055.180	180 mm
	BP.055.200	200 mm

Suture forceps / Penseta do nitok



DS.650.160
Falcon
160 mm

Director fistula grooved / Zgłębnik rowkowy z sondą

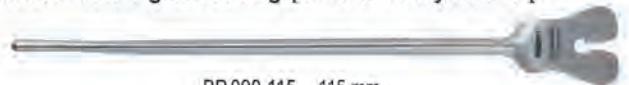

BP.090.115	115 mm
BP.090.130	130 mm
BP.090.145	145 mm
BP.090.160	160 mm
BP.090.180	180 mm
BP.090.200	200 mm

Gauze packers / Upychadło do tamponów



Luniatschek
DS.350.017 2mm fig. 1



Luniatschek
DS.350.027 3mm fig. 2

D₁₂

Impression Accessories / Akcesoria do wycisków

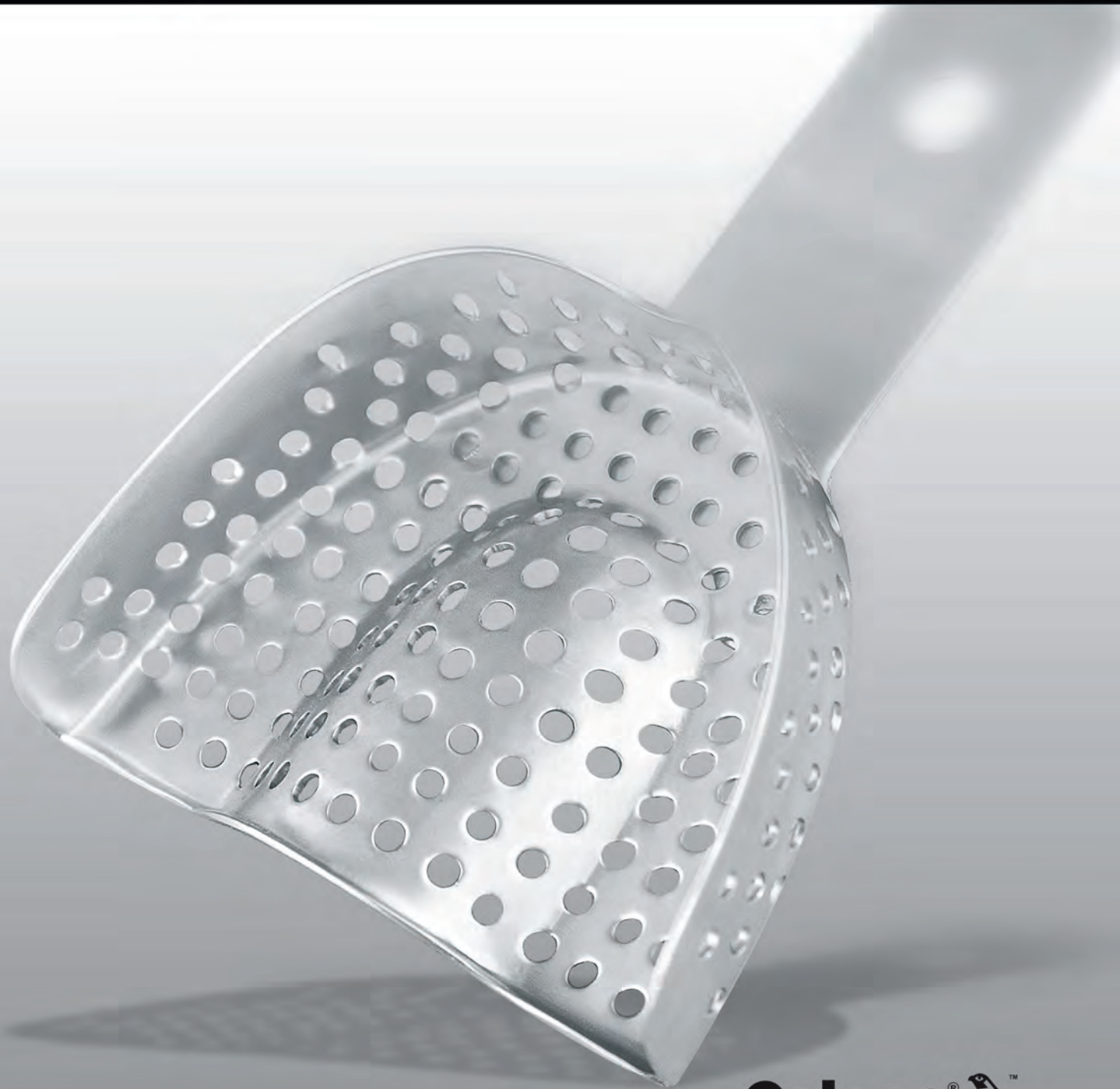



Uni**press**[®]

all for 1 – 1 for all



DI.1150.00

Universal dispenser kit for all ratios of 25ml and 50ml cartridges
Uniwersalny zestaw pasuje do wszystkich proporcji 25ml i 50ml naboí

Contents / Zawiera:

- 1 1 x Dispenser / 1 x Pistolet
- 2 1 x Cartridge holder for rectangular flange cartridges (old type) / 1 x Uchwyt do prostokątnych naboí (stary typ)
- 3 1 x Cartridge holder for round flange cartridges (new type) / 1 x Uchwyt do okrągłych naboí (nowy typ)
- 4 1 x Plunger for 1:1/2:1 ratio / 1 x Wspornik dla proporcji 1:1/2:1
- 5 1 x Plunger for 4:1 ratio / 1 x Wspornik dla proporcji 4:1
- 6 1 x Plunger for 10:1 ratio / 1 x Wspornik dla proporcji 10:1



Disposable mixing tips
Jednorazowe końcówki do mieszania

DENTALINE®
The Single-Use Product Specialists™



DI.1107.00
Red, pack of 50
Czerwone opak.50 szt.



DI.1107.01
Blue, pack of 50
Niebieskie opak.50 szt.



DI.1107.02
Green, pack of 50
Zielone opak.50 szt.



DI.1107.03
White, pack of 50
Białe opak.50 szt.



DI.1107.04
Yellow, pack of 50
Żółte opak.50 szt.



DI.1107.05
Yellow, pack of 50
Żółte opak.50 szt.

Intraoral tips
Kończówki wewnątrzustne



DI.1100.00
Clear, pack of 50
Przeźroczyste,
Opak.50 szt.



DI.1100.01
Clear, pack of 50
Przeźroczyste,
Opak.50 szt.



DI.1100.03
Green, pack of 50
Zielone, Opak.50 szt.



DI.1100.04
Pink, pack of 50
Różowe, Opak.50 szt.



DR.9801.00
Clear, pack of 50
Przeźroczyste,
Opak.50 szt.

DR.9800.00
Clear, pack of 50
Przeźroczyste,
Opak.50 szt.



DR.9800.03
Pack of 50
Opak.50 szt.



DI.1100.06
Pack of 50
Opak.50 szt.



DI.1100.02
Yellow, pack of 50
Żółte, Opak.50 szt.



DI.1100.05
Yellow, pack of 100
Żółte, Opak.100 szt.



Mixing tips 1:1 ratio

Końcówki do mieszania (proporcja 1:1)



Mixing tips 4:1 ratio

Końcówki do mieszania (proporcja 4:1)

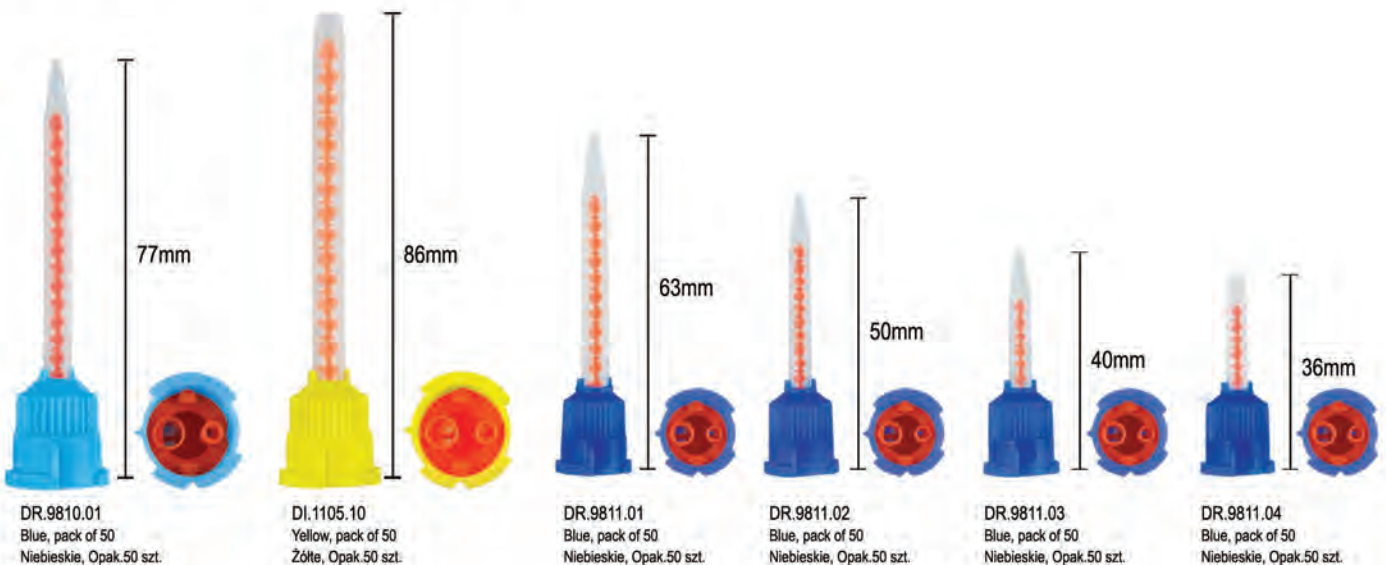



Mixing tips 1:1 ratio
Końcówki do mieszania (proporcja 1:1)



DI.1108.01
Green, pack of 48
Zielone, Opak.48 szt.

DI.1108.03
Yellow, pack of 48
Żółte, Opak.48 szt.

DR.9816.03
Blue, pack of 48
Niebieskie, Opak.48 szt.



DI.1106.01
Green, pack of 50
Zielone, Opak.50 szt.

DI.1106.02
Pink, pack of 50
Różowe, Opak.50 szt.

DI.1106.03
Yellow, pack of 50
Żółte, Opak.50 szt.

Impression gun holder and mixing tips dispenser
Stojak na pistolet i pojemnik na końcówki mieszające



DR.9816.01
Blue, pack of 48
Niebieskie, Opak.48 szt.
4:1/10:1

DR.9815.01
Brown, pack of 50
Brązowe, Opak.50 szt.

DR.9815.02
Brown, pack of 50
Brązowe, Opak.50 szt.

DR.9814.01
Brown, pack of 50
Brązowe, Opak.50 szt.



DI.9999.00
265 x 140 x 150 mm

Disposable impression syringes
Jednorazowe strzykawki do masy



DI.016.000
Pack of 25 / Opak. zawiera 25 szt.



DI.016.010
12ml
Pack of 50 / Opak. zawiera 50 szt.



Bite gauge / Linijka pomiarowa

A simple measuring instrument as an aid in the re-establishment of correct facial contour during full or partial denture work.
Instrument do mierzenia odcinków twarzy



DI.001.000
Falcon

Slide **B** is fully adjustable and reversible along shaft **A** and may be fixed in any position by means of its locking-screw as shown.
Suwak **B** jest regulowany i może być dostosowany do każdej pozycji dzięki śrubie blokującej.

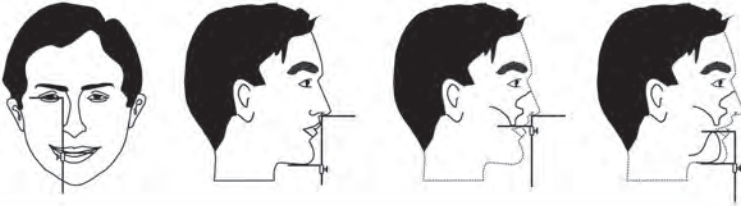

Bio-Art fox ruler
Płytki Foxa do okluzji

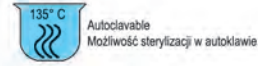

Made in Brazil



BIO.1.18A
Fox ruler aluminium / Płytki Foxa aluminiowa

BIO.1.18P
Fox ruler polymer / Płytki Foxa plastikowa

Gingival cord packers / Upychadła do nici retrakcyjnych



DI.004.015
Fischer
Serrated / Ząbkowane



DI.004.025
Fischer
Serrated / Ząbkowane



DI.005.010
Serrated / Ząbkowane



DI.005.020
Smooth / Bez ząbków



DI.005.014
Serrated / Ząbkowane



DI.005.024
Smooth / Bez ząbków



Carvers for silicone impression materials
Nożyki do silikonu

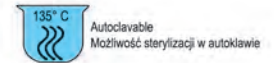

DI.010.014



DI.010.017

Disposable impression trays for implants
Jednorazowe łyżki wyciskowe do implantów

Trial Pack
DI.028.000
10 assorted trays
Mix 10 łyżek

Pack of 10 pieces
Opak. 10 szt.



Fig.1
Upper L / górna L
DI.028.010

Fig.3
Upper M / górna M
DI.028.030

Fig.5
Upper S / górna S
DI.028.050

Fig.9
Upper Anterior / Górna przednia
DI.028.090

Fig.10
Lower Anterior / Dolna przednia
DI.028.100



Fig.2
Lower L / Dolna L
DI.028.020

Fig.4
Lower M / Dolna M
DI.028.040

Fig.6
Lower S / Dolna S
DI.028.060

Fig.8
Prawa górna / Lewy dół
DI.028.080

Fig.7
Lewa górna / Prawy dół
DI.028.070

DENTALINE[®]
The Single-Use Product Specialists™

1-2-3 impression trays
1-2-3 łyżki wyciskowe

For simultaneous crown and bridge impression,
counter impression and bite registration.

Zapewniają jednoczesne wykonanie wycisku górnego,
wycisku dolnego oraz rejestracji zgryzu.



Fig.1
DI.040.010
posterior
ćwiartkowa z wysokim brzegiem

Pack of 36 pieces
Opak. 36 szt.



Fig.2
DI.040.020
anterior
przednia częściowa

Pack of 36 pieces
Opak. 36 szt.



Fig.3
DI.040.030
posterior sideless
połówkowa z niskim brzegiem

Pack of 36 pieces
Opak. 36 szt.



Fig.4
DI.040.040
posterior sideless
połówkowa z wysokim brzegiem

Pack of 36 pieces
Opak. 36 szt.



Fig.5
DI.040.050
full arch
przednia całościowa

Pack of 24 pieces
Opak. 24 szt.



Disposable impression trays / Jednorazowe łyżki wyciskowe

DENTALINE[®]
The Single-Use Product Specialists™

Pack includes 25 trays of 1 size and 1 handle
Opak. zawiera 25 łyżek z (1 rozmiaru)+1 uchwyt



Fig. 3
Edentulous upper L
Do bezzębia górna L
DI.023.030



Fig. 4
Edentulous lower L
Do bezzębia dolna L
DI.023.040



Fig. 5
Edentulous upper M
Do bezzębia górna M
DI.023.050



Fig. 6
Edentulous lower M
Do bezzębia dolna M
DI.023.060



Fig. 11
Dentate upper L
do ubytków częściowych górna L
DI.023.110



Fig. 12
Dentate lower L
do ubytków częściowych dolna L
DI.023.120



Fig. 13
Dentate upper M
do ubytków częściowych górna M
DI.023.130



Fig. 14
Dentate lower M
do ubytków częściowych dolna M
DI.023.140



Fig. 15
Orthodontic upper L
Ortodontyczna górna L
DI.023.150



Fig. 16
Orthodontic lower L
Ortodontyczna dolna L
DI.023.160



Fig. 17
Orthodontic upper M
Ortodontyczna górna M
DI.023.170



Fig. 18
Orthodontic lower M
Ortodontyczna dolna M
DI.023.180



Fig. 20
Partial anterior
Połówkowa przód
DI.023.200



Fig. 21
Upper left / Lower right
Lewa górna / Prawy dół
DI.023.210



Fig. 22
Upper right / Lower left
Lewa górna / Prawy dół
DI.023.220



Spare metal handle / Uchwyt metalowy do łyżki wyciskowej



DI.020.010
Pack of 10 pieces
Opak. 10 szt.



Autoclavable
Możliwość sterylizacji
w autoklawie

Constructed of durable plastic for optimum strength.
All trays are perforated to ensure excellent retention of impression material.
Each box contains 25 trays of one size and 1 handle.
Latex-free.

Łyżki wyciskowe wykonane są z plastiku o odpowiedniej wytrzymałości.
Posiadają perforację, która zapewnia doskonałe trzymanie masy wyciskowej.
Pudełko zawiera 25 łyżek wyciskowych jednego rozmiaru oraz 1 uchwyt.
Nie zawierają lateksu.



Disposable impression trays / Jednorazowe łyżki wyciskowe

DENTALINE[®]
The Single-Use Product Specialists™

Pack includes 25 trays of 1 size and 1 handle
Opak. zawiera 25 łyżek z (1 rozmiaru)+1 uchwyt



Fig. 3
Edentulous upper L
Do bezzębia górna L
DI.024.030



Fig. 4
Edentulous lower L
Do bezzębia dolna L
DI.024.040



Fig. 5
Edentulous upper M
Do bezzębia górna M
DI.024.050



Fig. 6
Edentulous lower M
Do bezzębia dolna M
DI.024.060



Fig. 11
Dentate upper L
do ubytków częściowych górna L
DI.024.110



Fig. 12
Dentate lower L
do ubytków częściowych dolna L
DI.024.120



Fig. 13
Dentate upper M
do ubytków częściowych górna M
DI.024.130



Fig. 14
Dentate lower M
do ubytków częściowych dolna M
DI.024.140



Fig. 15
Orthodontic upper L
Ortodontyczna górna L
DI.024.150



Fig. 16
Orthodontic lower L
Ortodontyczna dolna L
DI.024.160



Fig. 17
Orthodontic upper M
Ortodontyczna górna M
DI.024.170



Fig. 18
Orthodontic lower M
Ortodontyczna dolna M
DI.024.180



Fig. 20
Partial anterior
Połówkowa przód
DI.024.200



Fig. 21
Upper left / Lower right
Lewa górna / Prawy dół
DI.024.210



Fig. 22
Upper right / Lower left
Lewa górna / Prawy dół
DI.024.220



Spare metal handle / Uchwyt metalowy do łyżki wyciskowej



DI.020.010
Pack of 10 pieces
Opak. 10 szt.



Autoclavable
Możliwość sterylizacji
w autoklawie



Constructed of durable plastic for optimum strength.
All trays are perforated to ensure excellent retention of impression material.
Each box contains 25 trays of one size and 1 handle.
Latex-free.

Łyżki wyciskowe wykonane są z plastiku o odpowiedniej wytrzymałości.
Posiadają perforację, która zapewnia doskonale trzymanie masy wyciskowej.
Pudełko zawiera 25 łyżek wyciskowych jednego rozmiaru oraz 1 uchwyt.
Nie zawierają lateksu.



Disposable impression trays / Jednorazowe łyżki wyciskowe

DENTALINE®
The Single-Use Product Specialists™

Pack includes 25 trays of 1 size and 1 handle
Opak. zawiera 25 łyżek z (1 rozmiaru)+1 uchwyt



Fig. 3
Edentulous upper L
Do bezzębia górna L
DI.025.030



Fig. 4
Edentulous lower L
Do bezzębia dolna L
DI.025.040



Fig. 5
Edentulous upper M
Do bezzębia górna M
DI.025.050



Fig. 6
Edentulous lower M
Do bezzębia dolna M
DI.025.060



Fig. 11
Dentate upper L
do ubytków częściowych górna L
DI.025.110



Fig. 12
Dentate lower L
do ubytków częściowych dolna L
DI.025.120



Fig. 13
Dentate upper M
do ubytków częściowych górna M
DI.025.130



Fig. 14
Dentate lower M
do ubytków częściowych dolna M
DI.025.140



Fig. 15
Orthodontic upper L
Ortodontyczna górna L
DI.025.150



Fig. 16
Orthodontic lower L
Ortodontyczna dolna L
DI.025.160



Fig. 17
Orthodontic upper M
Ortodontyczna górna M
DI.025.170



Fig. 18
Orthodontic lower M
Ortodontyczna dolna M
DI.025.180



Fig. 20
Partial anterior
Połówkowa przód
DI.025.200



Fig. 21
Upper left / Lower right
Lewa górna / Prawy dół
DI.025.210



Fig. 22
Upper right / Lower left
Lewa górna / Prawy dół
DI.025.220



Spare metal handle / Uchwyt metalowy do łyżki wyciskowej



DI.020.010
Pack of 10 pieces
Opak. 10 szt.



Autoclavable
Możliwość sterylizacji
w autoklawie



Constructed of durable plastic for optimum strength.
All trays are perforated to ensure excellent retention of impression material.
Each box contains 25 trays of one size and 1 handle.
Latex-free.

Łyżki wyciskowe wykonane są z plastiku o odpowiedniej wytrzymałości.
Posiadają perforację, która zapewnia doskonale trzymanie masy wyciskowej.
Pudełko zawiera 25 łyżek wyciskowych jednego rozmiaru oraz 1 uchwyt.
Nie zawierają lateksu.



Disposable impression trays / Jednorazowe łyżki wyciskowe

DENTALINE[®]
The Single-Use Product Specialists™

Pack includes 25 trays of 1 size and 1 handle
Opak. zawiera 25 łyżek z (1 rozmiaru)+1 uchwyt



Fig. 3
Edentulous upper L
Do bezzębia górna L
DI.026.030



Fig. 4
Edentulous lower L
Do bezzębia dolna L
DI.026.040



Fig. 5
Edentulous upper M
Do bezzębia górna M
DI.026.050



Fig. 6
Edentulous lower M
Do bezzębia dolna M
DI.026.060



Fig. 11
Dentate upper L
do ubytków częściowych górna L
DI.026.110



Fig. 12
Dentate lower L
do ubytków częściowych dolna L
DI.026.120



Fig. 13
Dentate upper M
do ubytków częściowych górna M
DI.026.130



Fig. 14
Dentate lower M
do ubytków częściowych dolna M
DI.026.140



Fig. 15
Orthodontic upper L
Ortodontyczna górna L
DI.026.150



Fig. 16
Orthodontic lower L
Ortodontyczna dolna L
DI.026.160



Fig. 17
Orthodontic upper M
Ortodontyczna górna M
DI.026.170



Fig. 18
Orthodontic lower M
Ortodontyczna dolna M
DI.026.180



Fig. 20
Partial anterior
Połówkowa przód
DI.026.200



Fig. 21
Upper left / Lower right
Lewa górna / Prawy dół
DI.026.210



Fig. 22
Upper right / Lower left
Lewa górna / Prawy dół
DI.026.220



Spare metal handle / Uchwyt metalowy do łyżki wyciskowej



DI.020.010
Pack of 10 pieces
Opak. 10 szt.



Autoclavable
Możliwość sterylizacji
w autoklawie



Constructed of durable plastic for optimum strength.
All trays are perforated to ensure excellent retention of impression material.
Each box contains 25 trays of one size and 1 handle.
Latex-free.

Łyżki wyciskowe wykonane są z plastiku o odpowiedniej wytrzymałości.
Posiadają perforację, która zapewnia doskonale trzymanie masy wyciskowej.
Pudełko zawiera 25 łyżek wyciskowych jednego rozmiaru oraz 1 uchwyt.
Nie zawierają lateksu.



Pro-Lock Disposable orthodontic impression trays
Pro-Lock Jednorazowe Ortodontyczne łyżki wyciskowe

Pack includes 10 trays of 1 size
Opak. zawiera 10 łyżek z 1 rozmiaru



Fig.1
DI.036.010
Upper XXS
Górna XXS



Fig.2
DI.036.020
Upper XS
Górna XS



Fig.3
DI.036.030
Upper S
Górna S



Fig.4
DI.036.040
Upper M
Górna M



Fig.5
DI.036.050
Upper L
Górna L



Fig.6
DI.036.060
Upper XL
Górna XL



Fig.1
DI.035.010
Lower XXS
Dolna XXS



Fig.2
DI.035.020
Lower XS
Dolna XS



Fig.3
DI.035.030
Lower S
Dolna S



Fig.4
DI.035.040
Lower M
Dolna M



Fig.5
DI.035.050
Lower L
Dolna L



Fig.6
DI.035.060
Lower XL
Dolna XL

Tuff-Lock Disposable orthodontic impression trays
Tuff-Lock Jednorazowe Ortodontyczne łyżki wyciskowe

Pack includes 10 trays of 1 size
Opak. zawiera 10 łyżek z 1 rozmiaru



Fig.5
DI.038.050
Upper XS
Górna XS



Fig.4
DI.038.040
Upper S
Górna S



Fig.3
DI.038.030
Upper M
Górna M



Fig.2
DI.038.020
Upper L
Górna L



Fig.1
DI.038.010
Upper L
Górna L



Fig.5
DI.037.050
Lower XS
Dolna XS



Fig.4
DI.037.040
Lower S
Dolna S



Fig.3
DI.037.030
Lower M
Dolna M



Fig.2
DI.037.020
Lower L
Dolna L



Fig.1
DI.037.010
Lower XL
Dolna XL



Disposable impression trays / Jednorazowe łyżki wyciskowe

DENTALINE[®]
The Single-Use Product Specialists™

Pack includes 25 trays of 1 size and 1 handle
Opak. zawiera 25 łyżek z (1 rozmiaru)+1 uchwyt



Fig. 3
DI.027.030
Edentulous upper L
Do bezzębia górna L



Fig. 4
DI.027.040
Edentulous lower L
Do bezzębia dolna L



Fig. 5
DI.027.050
Edentulous upper M
Do bezzębia górna M



Fig. 6
DI.027.060
Edentulous lower M
Do bezzębia dolna M



Fig. 9
DI.027.090
Dentate upper XL
Do ubytków częściowych górna XL



Fig. 10
DI.027.100
Dentate lower XL
Do ubytków częściowych dolna XL



Fig. 11
DI.027.110
Dentate upper L
Do ubytków częściowych górna L



Fig. 12
DI.027.120
Dentate lower L
Do ubytków częściowych dolna L



Fig. 13
DI.027.130
Dentate upper M
Do ubytków częściowych górna M



Fig. 14
DI.027.140
Dentate lower M
Do ubytków częściowych dolna M



Fig. 15
DI.027.150
Orthodontic upper M
Ortodontyczna górna M



Fig. 16
DI.027.160
Orthodontic lower M
Ortodontyczna dolna M



Fig. 17
DI.027.170
Orthodontic upper S
Ortodontyczna górna S



Fig. 18
DI.027.180
Orthodontic lower S
Ortodontyczna dolna S

Metal handle
Uchwyt metalowy



Autoclavable
Możliwość sterylizacji w autoklawie



DI.020.020
Pack of 10 pieces
Opak. 10 szt.





Color CODED
For easy identification

Clear to permit a visual check for accuracy of fit and to aid correct location

Rigid plastic material allows the use of all impression materials

Perforated and micro etched surface for better retention of impression material

Smooth rims/edges for improved patient comfort

Anatomically correct design and rigid plastic for accurate impressions

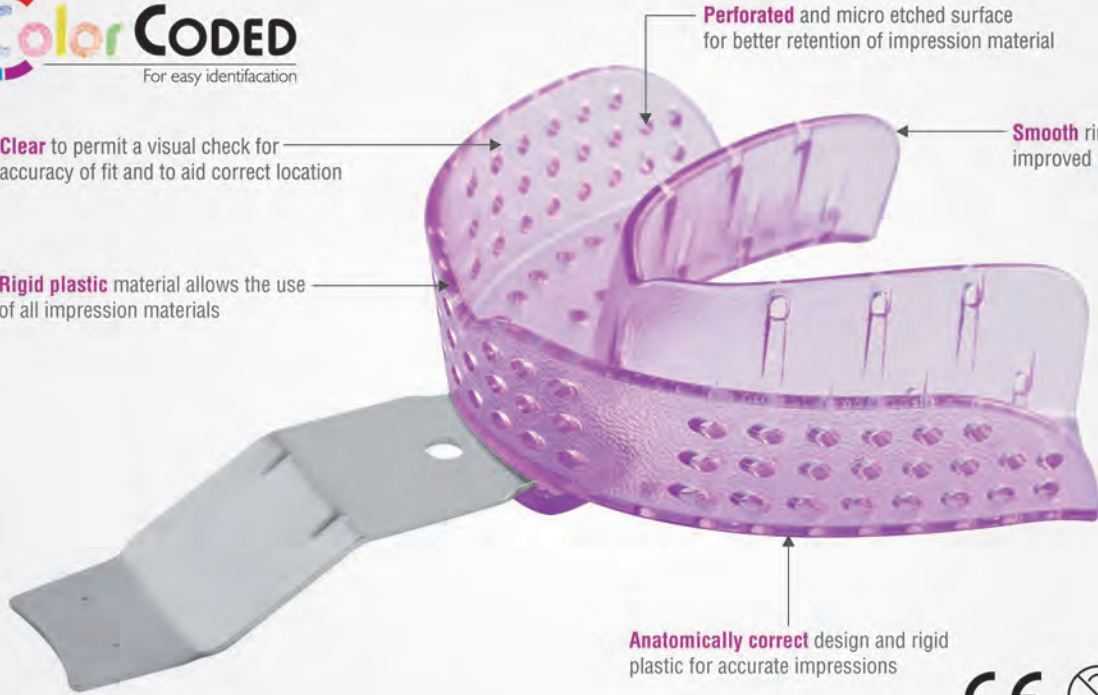

Sturdy, non-bend double ended metal handle for both upper and lower trays

Supplied in **see through** dispenser box

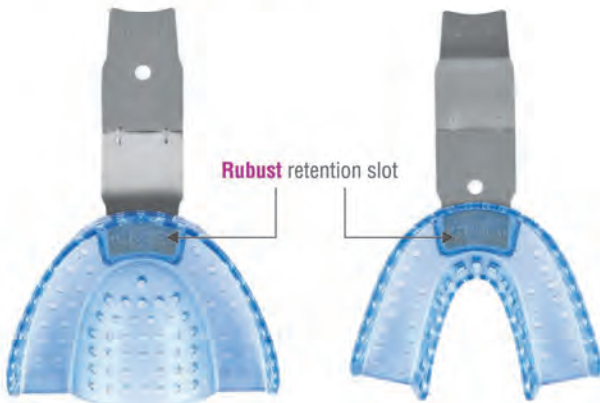

Edentulous



No. 3 **DI.027.003**
Edentulous upper deep
25 per pack + 1 metal handle

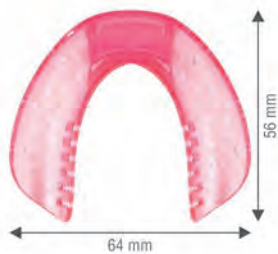

No. 4 **DI.027.004**
Edentulous lower deep
25 per pack + 1 metal handle



No. 5 **DI.027.005**
Edentulous upper shallow
25 per pack + 1 metal handle



No. 6 **DI.027.006**
Edentulous lower shallow
25 per pack + 1 metal handle



Dentate

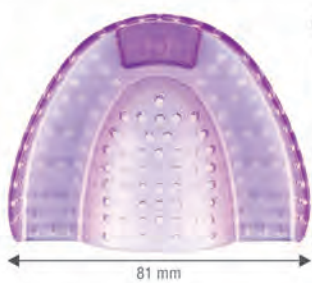

No. 9 **DI.027.009**
Dentate upper x-large
15 per pack + 1 metal handle

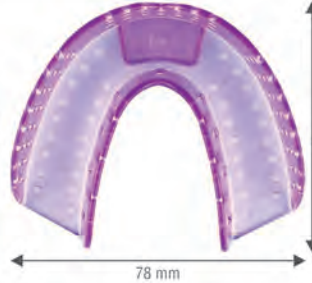

No. 10 **DI.027.010**
Dentate lower x-large
15 per pack + 1 metal handle

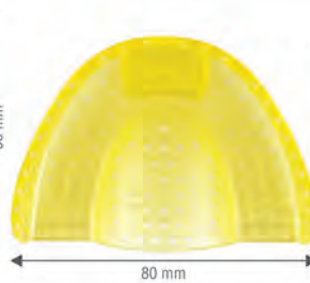

No. 11 **DI.027.011**
Dentate upper large
25 per pack + 1 metal handle



No. 12 **DI.027.012**
Dentate lower large
25 per pack + 1 metal handle

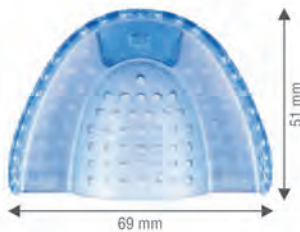

No. 13 **DI.027.013**
Dentate upper medium
25 per pack + 1 metal handle

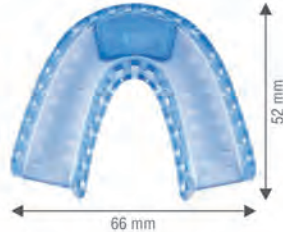

No. 14 **DI.027.014**
Dentate lower medium
25 per pack + 1 metal handle



No. 15 **DI.027.015**
Dentate/Ortho upper medium
25 per pack + 1 metal handle



No. 16 **DI.027.016**
Dentate/Ortho lower medium
25 per pack + 1 metal handle



No. 17 **DI.027.017**
Dentate/Ortho upper small
25 per pack + 1 metal handle

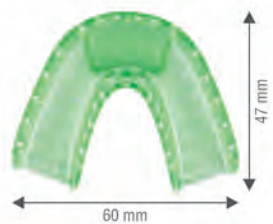

No. 18 **DI.027.018**
Dentate/Ortho lower small
25 per pack + 1 metal handle

Re-usable metal handle



DI.020.030
Sturdy, non-bend, double ended metal handle for both upper and lower trays. Autoclavable pack of 10

Partial

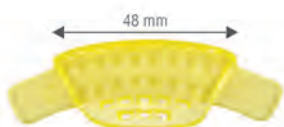

No. 20 **DI.027.020**
Partial anterior
25 per pack



No. 21 **DI.027.021**
Upper left / Lower right
25 per pack

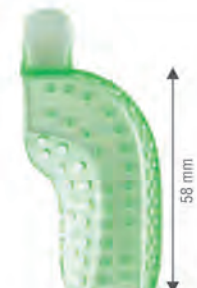

No. 22 **DI.027.022**
Upper right / Lower left
25 per pack



Disposable impression trays / Jednorazowe łyżki wyciskowe

DENTALINE

Disposable transparent impression trays
Jednorazowe łyżki wyciskowe przezroczyste

Pack of 25 pieces
Opak. 25 szt.



Fig.1
Upper / Górna L
DI.032.010



Fig.3
Upper / Górna M
DI.032.030



Fig.5
Upper / Górna S
DI.032.050



Fig.7
UL/LR
DI.032.070



Fig.9
Anterior lower / Boczna dolna
DI.032.090



Fig.2
Lower / Dolna L
DI.032.020



Fig.4
Lower / Dolna M
DI.032.040



Fig.6
Lower / Dolna S
DI.032.060



Fig.8
UR/LL
DI.032.080



Fig.10
Anterior upper / Boczna Górna
DI.032.100

DENTALINE

Disposable transparent impression trays
Jednorazowe łyżki wyciskowe przezroczyste

Pack of 10 pieces
Opak. 10 szt.



Fig.1
Upper / Górna L
DI.029.010



Fig.2
Lower / Dolna L
DI.029.020



Fig.3
Upper / Górna M
DI.029.030



Fig.4
Lower / Dolna M
DI.029.040



Fig.5
Upper / Górna S
DI.029.050



Fig.6
Lower / Dolna S
DI.029.060



Fig.7
UL/LR
DI.029.070



Fig.8
UR/LL
DI.029.080



Fig.9
Partial anterior / Połówkowa dolna
DI.029.090

Trial Pack
DI.029.000
9 assorted trays
Mix 9 łyżek





Disposable impression trays / Jednorazowe łyżki wyciskowe

DENTALINE

Disposable impression trays
Jednorazowe łyżki wyciskowe

Pack of 10 pieces
Opak. 10 szt.

For simultaneous crown and bridge impression,
counter impression and bite registration.

Zapewniają jednoczesne wykonanie wycisku górnego,
wycisku dolnego oraz rejestracji zgryzu.

Trial Pack
DI.039.000
10 assorted trays / Mix 10 łyżek

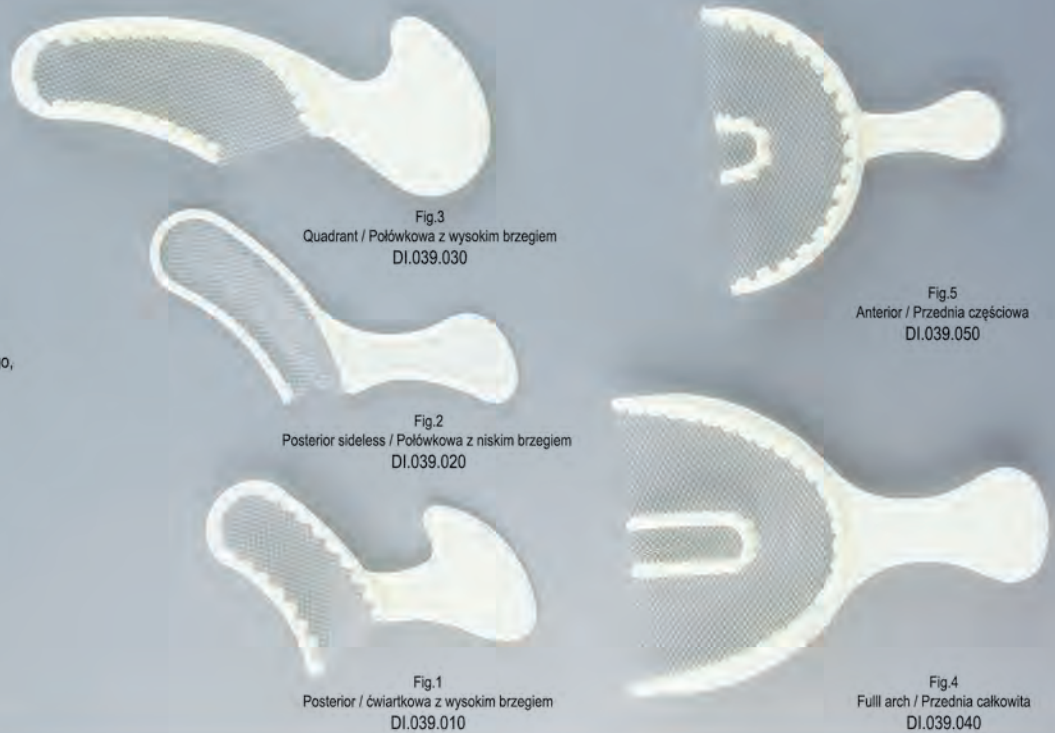

ID-Color
Impression Trays / łyżki wyciskowe

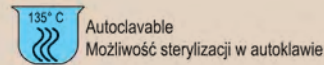

- Color Coded for easy identification of size
- Micro etched inner surface for better retention
- Available perforated or solid

- Łatwa identyfikacja rozmiaru dzięki zastosowaniu kolorowych oznaczeń.
- Mikrożłobienia na wewnętrznej powierzchni łyżki w celu uzyskania lepszej retencji.
- W ofercie łyżki gładkie lub perforowane.

Made of high quality non-magnetic stainless steel (AISI304).
Micro etched inner surface for better retention.

Wykonane z wysokiej jakości antymagnetycznej stali nierdzewnej (AISI304).
Mikrożłobienia na wewnętrznej powierzchni łyżki w celu uzyskania lepszej retencji.

ID-Color

Regular Impression trays with rim, perforated
łyżki wyciskowe do ubytków częściowych perforowane z brzegiem retencyjnym



Lower / Dolna

No.	Size	A mm	B mm	Code / Kod	Color / Kolor
L1	XL	80	63	DI.801.010	Purple
L2	L	78	59	DI.801.020	Green
L3	M	76	57	DI.801.030	Blue
L4	S	72	57	DI.801.040	Red
L5	XS	69	50	DI.801.050	Yellow

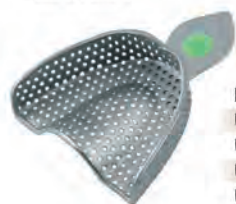

Upper / Górna

No.	Size	A mm	B mm	Code / Kod	Color / Kolor
U1	XL	81	63	DI.811.010	Purple
U2	L	74	60	DI.811.020	Green
U3	M	71	55	DI.811.030	Blue
U4	S	67	53	DI.811.040	Red
U5	XS	65	51	DI.811.050	Yellow



Sets / Zestawy	Contents / Zawierają	Code / Kod
6 pieces / sztuk	L2,L3,L4,U2,U3,U4	DI.851.060
10 pieces / sztuk	L1,L2,L3,L4,L5 U1,U2,U3,U4,U5	DI.851.000

ID-Color

Regular Impression trays with rim, solid
łyżki wyciskowe do ubytków częściowych pełne z brzegiem retencyjnym



Lower / Dolna

No.	Size	A mm	B mm	Code / Kod	Color / Kolor
L1	XL	80	63	DI.821.010	Purple
L2	L	78	59	DI.821.020	Green
L3	M	76	57	DI.821.030	Blue
L4	S	72	57	DI.821.040	Red
L5	XS	69	50	DI.821.050	Yellow



Upper / Górna

No.	Size	A mm	B mm	Code / Kod	Color / Kolor
U1	XL	81	63	DI.831.010	Purple
U2	L	74	60	DI.831.020	Green
U3	M	71	55	DI.831.030	Blue
U4	S	67	53	DI.831.040	Red
U5	XS	65	51	DI.831.050	Yellow



Sets / Zestawy	Contents / Zawierają	Code / Kod
6 pieces / sztuk	L2,L3,L4,U2,U3,U4	DI.861.060
10 pieces / sztuk	L1,L2,L3,L4,L5 U1,U2,U3,U4,U5	DI.861.000



D-Color

Impression Trays / Łyżki wyciskowe

- Color Coded for easy identification of size
- Micro etched inner surface for better retention
- Available perforated or solid

Made of high quality non-magnetic stainless steel (AISI304).
Micro etched inner surface for better retention.



Autoclavable
Możliwość sterylizacji w autoklawie

- Łatwa identyfikacja rozmiaru dzięki zastosowaniu kolorowych oznaczeń.
- Mikrożłobienia na wewnętrznej powierzchni łyżki w celu uzyskania lepszej retencji.
- W ofercie łyżki gładkie lub perforowane.

Wykonane z wysokiej jakości antymagnetycznej stali nierdzewnej (AISI304).
Mikrożłobienia na wewnętrznej powierzchni łyżki w celu uzyskania lepszej retencji.

Impression trays regular / Łyżki wyciskowe do ubytków częściowych

Perforated without rim
Perforowane bez brzegu retencyjnego

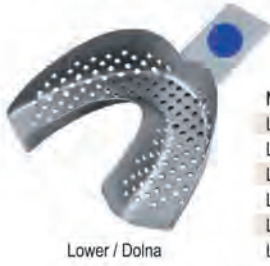

No.	Size	A mm	B mm	Code / Kod	Color / Kolor
L1	XXS	55	47	DI.701.010	
L2	XS	60	49	DI.701.020	
L3	S	72	54	DI.701.030	
L4	M	74	57	DI.701.040	
L5	L	76	59	DI.701.050	
L6	XL	78	61	DI.701.060	

Lower / Dolna

Perforated with rim
Perforowane z brzegiem retencyjnym



No.	Size	A mm	B mm	Code / Kod	Color / Kolor
L1	XXS	55	47	DI.751.010	
L2	XS	60	49	DI.751.020	
L3	S	72	54	DI.751.030	
L4	M	74	57	DI.751.040	
L5	L	76	59	DI.751.050	
L6	XL	78	61	DI.751.060	

Lower / Dolna

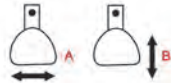
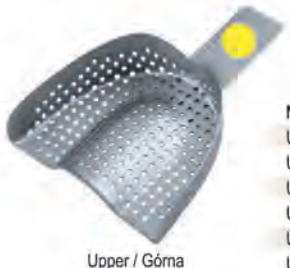

No.	Size	A mm	B mm	Code / Kod	Color / Kolor
U1	XXS	61	47	DI.706.010	
U2	XS	64	51	DI.706.020	
U3	S	66	53	DI.706.030	
U4	M	69	57	DI.706.040	
U5	L	71	60	DI.706.050	
U6	XL	73	62	DI.706.060	

Upper / Górna



No.	Size	A mm	B mm	Code / Kod	Color / Kolor
U1	XXS	61	47	DI.756.010	
U2	XS	64	51	DI.756.020	
U3	S	66	53	DI.756.030	
U4	M	69	57	DI.756.040	
U5	L	71	60	DI.756.050	
U6	XL	73	62	DI.756.060	

Upper / Górna

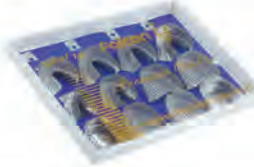

Sets / Zestawy	Contents / Zawierają	Code / Kod
6 pieces / sztuk	L3,L4,L5,U3,U4,U5	DI.721.060
8 pieces / sztuk	L3,L4,L5,L6,U3,U4,U5,U6	DI.721.080
12 pieces / sztuk	L1,L2,L3,L4,L5,L6 U1,U2,U3,U4,U5,U6	DI.721.000



Sets / Zestawy	Contents / Zawierają	Code / Kod
6 pieces / sztuk	L3,L4,L5,U3,U4,U5	DI.771.060
8 pieces / sztuk	L3,L4,L5,L6,U3,U4,U5,U6	DI.771.080
12 pieces / sztuk	L1,L2,L3,L4,L5,L6 U1,U2,U3,U4,U5,U6	DI.771.000

Solid without rim
Pełne bez brzegu retencyjnego



No.	Size	A mm	B mm	Code / Kod	Color / Kolor
L1	XXS	55	47	DI.711.010	
L2	XS	60	49	DI.711.020	
L3	S	72	54	DI.711.030	
L4	M	74	57	DI.711.040	
L5	L	76	59	DI.711.050	
L6	XL	78	61	DI.711.060	

Lower / Dolna

Solid with rim
Pełne z brzegiem retencyjnym

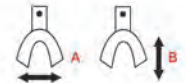

No.	Size	A mm	B mm	Code / Kod	Color / Kolor
L1	XXS	55	47	DI.761.010	
L2	XS	60	49	DI.761.020	
L3	S	72	54	DI.761.030	
L4	M	74	57	DI.761.040	
L5	L	76	59	DI.761.050	
L6	XL	78	61	DI.761.060	

Lower / Dolna

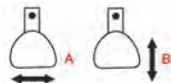

No.	Size	A mm	B mm	Code / Kod	Color / Kolor
U1	XXS	61	47	DI.716.010	
U2	XS	64	51	DI.716.020	
U3	S	66	53	DI.716.030	
U4	M	69	57	DI.716.040	
U5	L	71	60	DI.716.050	
U6	XL	73	62	DI.716.060	

Upper / Górna

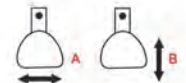

No.	Size	A mm	B mm	Code / Kod	Color / Kolor
U1	XXS	61	47	DI.766.010	
U2	XS	64	51	DI.766.020	
U3	S	66	53	DI.766.030	
U4	M	69	57	DI.766.040	
U5	L	71	60	DI.766.050	
U6	XL	73	62	DI.766.060	

Upper / Górna

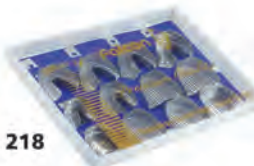

Sets / Zestawy	Contents / Zawierają	Code / Kod
6 pieces / sztuk	L3,L4,L5,U3,U4,U5	DI.726.060
8 pieces / sztuk	L3,L4,L5,L6,U3,U4,U5,U6	DI.726.080
12 pieces / sztuk	L1,L2,L3,L4,L5,L6 U1,U2,U3,U4,U5,U6	DI.726.000



Sets / Zestawy	Contents / Zawierają	Code / Kod
6 pieces / sztuk	L3,L4,L5,U3,U4,U5	DI.781.060
8 pieces / sztuk	L3,L4,L5,L6,U3,U4,U5,U6	DI.781.080
12 pieces / sztuk	L1,L2,L3,L4,L5,L6 U1,U2,U3,U4,U5,U6	DI.781.000



Autoclavable
Możliwość sterylizacji w autoklawie

Made of high quality non-magnetic stainless steel (AISI304).
Micro etched inner surface for better retention.

Wykonane z wysokiej jakości antymagnetycznej stali nierdzewnej (AISI304).
Mikrożłobienia na wewnętrznej powierzchni łyżki w celu uzyskania lepszej retencji.

Impression trays regular / Łyżki wyciskowe do ubytków częściowych

Perforated with rim
Perforowane z brzegiem retencyjnym



Lower / Dolna

No.	Size	A mm	B mm	Code / Kod
L1	XL	80	63	DI.800.010
L2	L	78	59	DI.800.020
L3	M	76	57	DI.800.030
L4	S	72	57	DI.800.040
L5	XS	69	50	DI.800.050



Upper / Górna

No.	Size	A mm	B mm	Code / Kod
U1	XL	81	63	DI.810.010
U2	L	74	60	DI.810.020
U3	M	71	55	DI.810.030
U4	S	67	53	DI.810.040
U5	XS	65	51	DI.810.050



Sets / Zestawy	Contents / Zawierają	Code / Kod
6 pieces / sztuk	L2,L3,L4,U2,U3,U4	DI.850.060
10 pieces / sztuk	L1,L2,L3,L4,L5 U1,U2,U3,U4,U5	DI.850.000

Solid with rim
Pełne z brzegiem retencyjnym



Lower / Dolna

No.	Size	A mm	B mm	Code / Kod
L1	XL	80	63	DI.820.010
L2	L	78	59	DI.820.020
L3	M	76	57	DI.820.030
L4	S	72	57	DI.820.040
L5	XS	69	50	DI.820.050



Upper / Górna

No.	Size	A mm	B mm	Code / Kod
U1	XL	81	63	DI.830.010
U2	L	74	60	DI.830.020
U3	M	71	55	DI.830.030
U4	S	67	53	DI.830.040
U5	XS	65	51	DI.830.050



Sets / Zestawy	Contents / Zawierają	Code / Kod
6 pieces / sztuk	L2,L3,L4,U2,U3,U4	DI.860.060
10 pieces / sztuk	L1,L2,L3,L4,L5 U1,U2,U3,U4,U5	DI.860.000

Impression trays for children / Łyżki wyciskowe dla dzieci

Perforated with rim
Perforowane z brzegiem retencyjnym



Lower / Dolna

No.	Size	A mm	B mm	Code / Kod
L1	S	54	47	DI.200.010
L2	M	62	51	DI.200.020
L3	L	70	55	DI.200.030



Upper / Górna

No.	Size	A mm	B mm	Code / Kod
U1	S	55	43	DI.210.010
U2	M	60	45	DI.210.020
U3	L	63	49	DI.210.030



Set / Zestaw	Contents / Zawiera	Code / Kod
6 pieces / sztuk	L1,L2,L3,U1,U2,U3	DI.250.000

Solid with rim
Pełne z brzegiem retencyjnym



Lower / Dolna

No.	Size	A mm	B mm	Code / Kod
L1	S	54	47	DI.220.010
L2	M	62	51	DI.220.020
L3	L	70	55	DI.220.030



Upper / Górna

No.	Size	A mm	B mm	Code / Kod
U1	S	55	43	DI.230.010
U2	M	60	45	DI.230.020
U3	L	63	49	DI.230.030



Set / Zestaw	Contents / Zawiera	Code / Kod
6 pieces / sztuk	L1,L2,L3,U1,U2,U3	DI.260.000

Impression trays regular Ehrlicke pattern perforated / Łyżki wyciskowe do ubytków częściowych perforowane mod. Ehrlicke



Lower / Dolna

No.	Size	A mm	B mm	Code / Kod
UB0	XS	65	46	DI.600.000
UB1	S	67	50	DI.600.010
UB2	M	76	54	DI.600.020
UB3	L	79	56	DI.600.030
UB4	XL	79	61	DI.600.040



DI.640.000
Set of 10 pieces / Zestaw 10 szt.
Contents / Zawiera
UB0,UB1,UB2,UB3,UB4
OB0,OB1,OB2,OB3,OB4



Upper / Górna

No.	Size	A mm	B mm	Code / Kod
OB0	XS	59	52	DI.610.000
OB1	S	66	52	DI.610.010
OB2	M	71	62	DI.610.020
OB3	L	71	64	DI.610.030
OB4	XL	80	70	DI.610.040



Impression trays edentulous / Łyżki wyciskowe do bezzębia

Perforated with rim
Perforowane z brzegiem retencyjnym



Lower / Dolna



No.	Size	A mm	B mm	Code / Kod
L1	XL	84	65	DI.300.010
L2	L	77	64	DI.300.020
L3	M	76	60	DI.300.030
L4	S	68	57	DI.300.040



Upper / Górna



No.	Size	A mm	B mm	Code / Kod
U1	XL	80	62	DI.310.010
U2	L	77	60	DI.310.020
U3	M	70	60	DI.310.030
U4	S	72	56	DI.310.040



Set / Zestaw 8 pieces / sztuk L1,L2,L3,L4,U1,U2,U3,U4 DI.350.000

Solid with rim
Pełne z brzegiem retencyjnym



Lower / Dolna

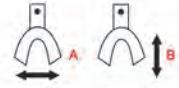

No.	Size	A mm	B mm	Code / Kod
L1	XL	84	65	DI.320.010
L2	L	77	64	DI.320.020
L3	M	76	60	DI.320.030
L4	S	68	57	DI.320.040



Upper / Górna

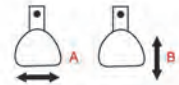

No.	Size	A mm	B mm	Code / Kod
U1	XL	80	62	DI.330.010
U2	L	77	60	DI.330.020
U3	M	70	60	DI.330.030
U4	S	72	56	DI.330.040



Set / Zestaw 8 pieces / sztuk L1,L2,L3,L4,U1,U2,U3,U4 DI.360.000

Impression trays anterior depressed / Łyżki wyciskowe do ubytków częściowych (saneczkowe)

Perforated with rim
Perforowane z brzegiem retencyjnym



Lower / Dolna

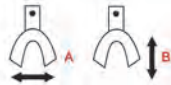

No.	Size	A mm	B mm	Code / Kod
L1	S	65	48	DI.500.010
L2	M	72	57	DI.500.020
L3	L	75	57	DI.500.030



Upper / Górna



No.	Size	A mm	B mm	Code / Kod
U1	S	64	56	DI.510.010
U2	M	67	60	DI.510.020
U3	L	72	63	DI.510.030



Set / Zestaw 6 pieces / sztuk L1,L2,L3,U1,U2,U3 DI.550.000

Solid with rim
Pełne z brzegiem retencyjnym



Lower / Dolna

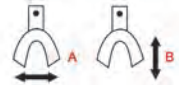

No.	Size	A mm	B mm	Code / Kod
L1	S	65	48	DI.520.010
L2	M	72	57	DI.520.020
L3	L	75	57	DI.520.030



Upper / Górna

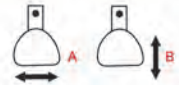

No.	Size	A mm	B mm	Code / Kod
U1	S	64	56	DI.530.010
U2	M	67	60	DI.530.020
U3	L	72	63	DI.530.030



Set / Zestaw 6 pieces / sztuk L1,L2,L3,U1,U2,U3 DI.560.000

Impression trays edentulous Ehrlicke pattern perforated / Łyżki wyciskowe do bezzębia perforowane mod. Ehrlicke



Lower / Dolna



No.	Size	A mm	B mm	Code / Kod
UU1	S	70	48	DI.400.010
UU2	M	70	53	DI.400.020
UU3	L	72	57	DI.400.030



DI.450.000
Set of 6 pieces / Zestaw 6 szt.
Contents / Zawiera
UU1,UU2,UU3, OU1,OU2,OU3



Upper / Górna



No.	Size	A mm	B mm	Code / Kod
OU1	S	64	46	DI.410.010
OU2	M	68	53	DI.410.020
OU3	L	79	61	DI.410.030



Made of high quality non-magnetic stainless steel (AISI304).
Micro etched inner surface for better retention.

Wykonane z wysokiej jakości antymagnetycznej stali nierdzewnej (AISI304).
Mikrożłobienia na wewnętrznej powierzchni łyżki w celu uzyskania lepszej retencji.

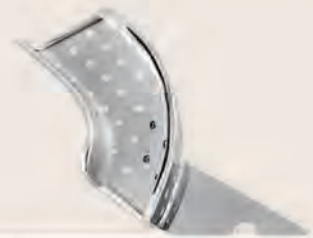

Partial impression trays for crown and bridge work / łyżki wyciskowe połówkowe

Perforated with rim / Perforowane z brzegiem retencyjnym



Fig. 30
DI.900.300
Upper left / Lower right
Górna lewa / Dolna prawa



Fig. 31
DI.900.310
Lower left / Upper right
Dolna lewa / Górna prawa



Fig. 32
DI.900.320
Lower jaw
Dolna przednia



Fig. 33
DI.900.330
Upper jaw
Górna przednia



Fig. 99
DI.900.990
Lateral
Boczna

Solid with rim / Pełne z brzegiem retencyjnym



Fig. 30
DI.905.300
Upper left / Lower right
Górna lewa / Dolna prawa



Fig. 31
DI.905.310
Lower left / Upper right
Dolna lewa / Górna prawa



Fig. 32
DI.905.320
Lower jaw
Dolna przednia



Fig. 33
DI.905.330
Upper jaw
Górna przednia



Fig. 99
DI.905.990
Lateral
Boczna

Perforated without rim / Perforowane bez brzegu retencyjnego



Lower left / Upper right
Dolna lewa / Górna prawa

No.	Size	Code / Kod
Fig. L2D	S	DI.899.040
Fig. L4D	M	DI.899.050
Fig. L6D	L	DI.899.060



Upper left / Lower right
Górna lewa / Dolna prawa

No.	Size	Code / Kod
Fig. L2S	S	DI.899.010
Fig. L4S	M	DI.899.020
Fig. L6S	L	DI.899.030

Perforated with rim / Perforowane z brzegiem retencyjnym



Lower left / Upper right
Dolna lewa / Górna prawa

No.	Size	Code / Kod
Fig. L2D	S	DI.901.040
Fig. L4D	M	DI.901.050
Fig. L6D	L	DI.901.060



Upper left / Lower right
Górna lewa / Dolna prawa

No.	Size	Code / Kod
Fig. L2S	S	DI.901.010
Fig. L4S	M	DI.901.020
Fig. L6S	L	DI.901.030



Impression Accessories Akcesoria do wycisków

Łyżki wyciskowe perforowane aluminiowe



Lower / Dolna

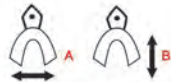

No.	Size	A mm	B mm	Code / Kod
L0	XXS	63	44	DI.950.010
L1	XS	69	47	DI.950.020
L2	S	72	48	DI.950.030
L3	M	74	50	DI.950.040
L4	L	75	53	DI.950.050
L5	XL	83	58	DI.950.060

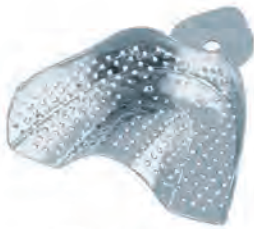

Upper / Górna



No.	Size	A mm	B mm	Code / Kod
U0	XXS	66	55	DI.960.010
U1	XS	69	56	DI.960.020
U2	S	71	57	DI.960.030
U3	M	73	58	DI.960.040
U4	L	75	62	DI.960.050
U5	XL	78	64	DI.960.060



DI.970.000
Set of 12 pieces / Zestaw 12 szt.
Contents / Zawiera
L0,L1,L2,L3,L4,L5, U0,U1,U2,U3,U4,U5

Łyżki wyciskowe perforowane półkolkowe aluminiowe



Lower left / Upper right
Dolna lewa / Górna prawa

No.	Size	Code / Kod
Fig. 1	S	DI.985.010
Fig. 2	M	DI.985.020
Fig. 3	L	DI.985.030



Upper left / Lower right
Górna lewa / Dolna prawa

No.	Size	Code / Kod
Fig. 1	S	DI.980.010
Fig. 2	M	DI.980.020
Fig. 3	L	DI.980.030

Rubber model bases Gumowa forma do modeli

Set of 6 pieces, assorted sizes, upper and lower
Zestaw 6 szt., różne rozmiary, górne i dolne



DL.091.010

Plastic model bases Jednorazowa plastikowa forma do modeli kontrolnych



Complete upper and lower with hinges
Komplet górny i dolny z zawiasami

DL.090.010	Standard / Standard
DL.090.020	Large / Duża

D-Color

Silicone buttons for impression trays / Oznaczenia silikonowe

Fit any impression tray, easy identification of size
Pasują do wszystkich metalowych łyżek wyciskowych
Łatwa identyfikacja rozmiaru łyżki



DI.999.000
Assorted pack of 24 buttons
6 colors, 4 of each color
Opak. zawiera 24 szt.
różnych oznaczeń silikonowych w
6 kolorach, po 4 szt. z każdego



135° C

Available in 6 colors / Dostępne w 6 kolorach:



Autoclavable
Możliwość sterylizacji w autoklawie

Impression trays holder

the bottom of the product is composed of a base, vertical frame, back slat, tray and hanging bar. It is mainly used to place the impression tray after getting the mold, to avoid sticking or squeezing deformation of the impression tray after getting the mold, and to more effectively ensure the completeness and accuracy of the



DI.9999.01

D₁₃

Laboratory / Protetyka

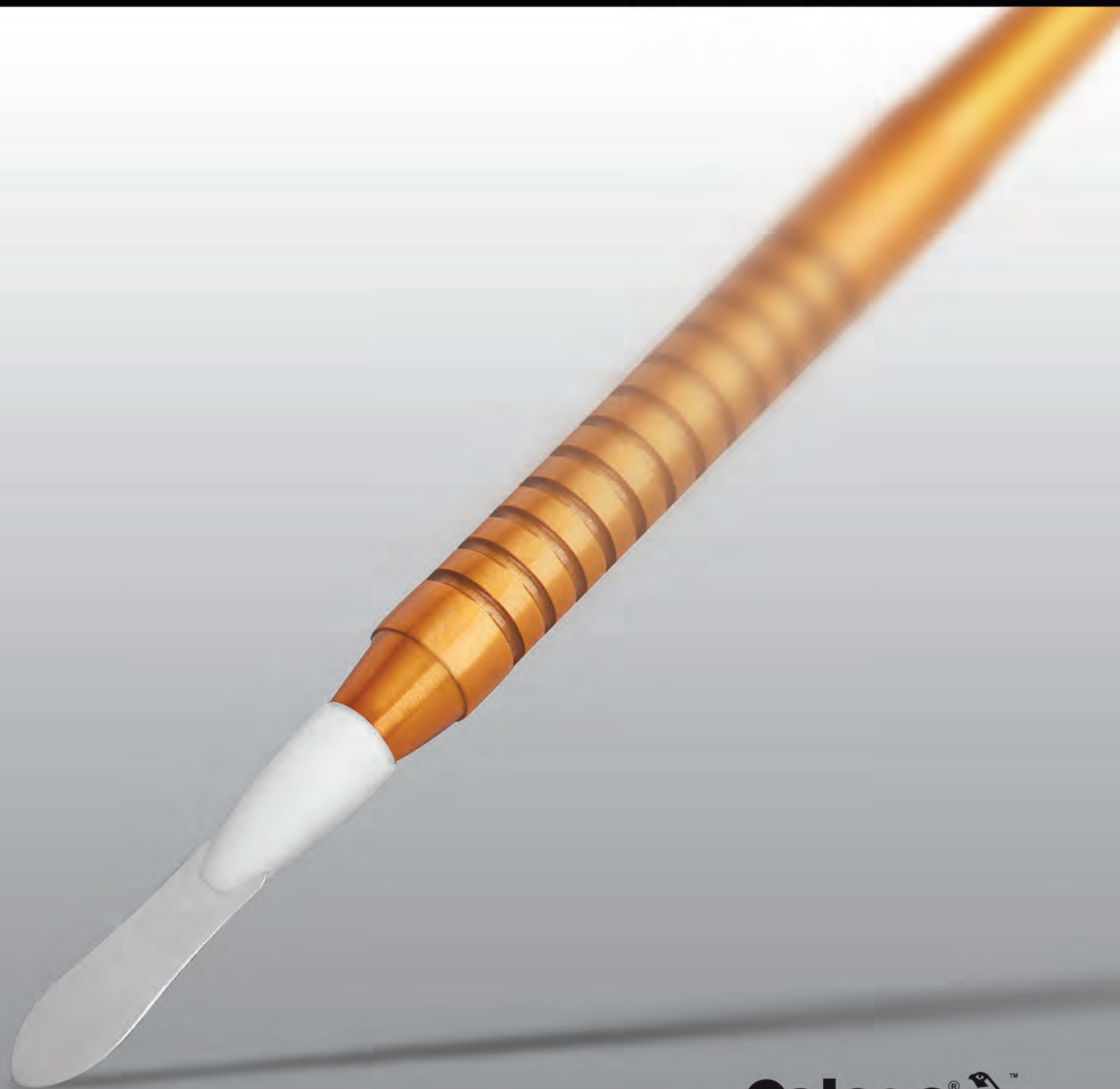

**Non-Precious dental alloys
Nieszlachetne stopy protetyczne**

Zapytaj o cenę

**Crown and bridge alloys
Stopy odlewnicze na korony i mosty**

Kera N®

Dental alloy for ceramics, Nickel base (Ni-Cr)
Stop niklowo-chromowy (Ni-Cr) pod porcelaną
Pack of 1kg.
Opak. zawiera 1 kg.

Typical chemical elements in % / Skład chemiczny %

Ni	Cr	Mo	Al	Si
~63	25, 75	11	< 0,4	1,5

Technical and physical data / Dane techniczno-fizyczne

Hardness after casting Twardość po odlewie	190 HV 10
Hardness after burning Twardość po napaleniu	185 HV 10
Solidus temperature Temperatura twardnienia	1260 °C
Liquidus temperature Temperatura krzepnięcia	1350 °C
Density Gęstość	8,2 g/cm ³
Coefficient of expansion (20-600°C) Współczynnik rozszerzalności cieplnej (20-600°C)	14,1 mm/mk
Size and weight of ingot Rozmiar i waga kostki	Ø 8 x 14,5 mm / ~6g

Kera N is a beryllium and iron-free Ni-Cr alloy
The strong oxide provides optimum metal/ceramic bonding
One of the remarkable features is the high corrosion resistance

Kera N jest stopem Ni-Cr pod porcelaną niezawierającym berylu i żelaza.
Zastosowanie oksydacji pozwala na optymalne połączenie metalu z ceramiką.
Odnacza się wysoką odpornością na korozję.

Kera C®

Dental alloy for ceramics, Nickel free (Co-Cr)
Stop kobaltowo-chromowy (Co-Cr) pod porcelaną bezniklowy
Pack of 1kg.
Opak. zawiera 1 kg.

Typical chemical elements in % / Skład chemiczny %

Co	Cr	Mo	Al	Si	Mn	W	Fe	Nb	V
~58	24,50	1	< 0,4	0,9	< 1	9	< 1,5	2	2

Technical and physical data / Dane techniczno-fizyczne

Hardness after casting Twardość po odlewie	360 HV 1
Hardness after burning Twardość po napaleniu	340 HV 10
Solidus temperature Temperatura twardnienia	1260 °C
Liquidus temperature Temperatura krzepnięcia	1350 °C
Density Gęstość	8,2 g/cm ³
Coefficient of expansion (20-600°C) Współczynnik rozszerzalności cieplnej (20-600°C)	14,1 mm/mk
Size and weight of ingot Rozmiar i waga kostki	Ø 8 x 14,5 mm / ~6g

Kera C is Co-Cr alloy for ceramics and is beryllium and nickel free
The strong oxide provides optimum metal/ceramic bonding
One of the remarkable features is the high corrosion resistance

Kera C jest stopem Co-Cr pod porcelaną niezawierającym berylu i niklu.
Zastosowanie oksydacji pozwala na optymalne połączenie metalu z ceramiką.
Odnacza się wysoką odpornością na korozję.

EDW®

Soft Dental alloy for composites, Nickel base (Ni-Cr)
Stop niklowo-chromowy (Ni-Cr) miękki pod kompozyty
Pack of 1kg.
Opak. zawiera 1 kg.

Pack of 1kg.
Opak. zawiera 1 kg.

Typical chemical elements in % / Skład chemiczny %

Ni	Cr	Mo	Mn	Si	Fe	C
~65	27,00	4,73	0,57	1,80	0,26	0,01

Technical and physical data / Dane techniczno-fizyczne

Hardness after casting Twardość po odlewie	210 HV 10
Solidus temperature Temperatura twardnienia	1210 °C
Liquidus temperature Temperatura krzepnięcia	1240 °C
Tensile Strength Wytrzymałość na rozciąganie	550 N/mm ³
Breaking elongation Rozciągliwość	Ca. 8%
Density Gęstość	8,2 g/cm ³
Size and weight of ingot Rozmiar i waga kostki	Ø 8 x 14,5 mm / ~6g

EDW is a beryllium free chrome/nickel alloy
One of the remarkable features is the high corrosion resistance

EDW jest stopem Ni-Cr niezawierającym berylu.
Odnacza się wysoką odpornością na korozję.



Non-Precious dental alloys Nieszlachetne stopy protetyczne



Zapytaj o cenę



Partial denture alloys Stopy do odlewania protez szkieletowych



Robur 400®

Partial denture alloy, Nickel free (Co-Cr)
Stop kobaltowo-chromowy (Co-Cr) do odlewania struktur metalowych protez szkieletowych, bezniklowy
Pack of 1kg.
Opak. zawiera 1 kg.

Typical chemical elements in % / Skład chemiczny %

Co	Cr	Mo	Mn	Al	Si	W	Fe	C
~65	29	6	0,6	<0,4	0,4	1	<1	0,5

Technical and physical data / Dane techniczno-fizyczne

Hardness after casting Twardość po odlewie	Ca.400 HV 10
Casting temperature Temperatura topienia	ca. 1,450
Solidus temperature Temperatura twardnienia	1340 °C
Liquidus temperature Temperatura krzepnięcia	1370 °C
Density Gęstość	8,3 g / cm
Tensile strength Wytrzymałość na rozciąganie	900 N/mm ²
Breaking elongation Rozciągłość	> 6 %
Modulus of elasticity Sprężystość	230,000
Size and weight of ingot Rozmiar i waga kostki	Ø 8 x 14,5 mm / ~6g

Robur 400 is an extremely pure cast alloy on cobalt base, exclusively made of fresh and pre-tested ore. This is an important requirement for high histocompatibility.

Highest mechanical features and best cast ability make room for individual and esthetical denture creation. Simple elaboration as well as good polishing and gloss results are typical.

Robur 400 jest stopem do odlewania struktur metalowych protez szkieletowych o wysokiej sprężystości na bazie kobaltu, który jest produkowany wyłącznie ze sprawdzonych kruszców.

Charakteryzuje się dobrą leżnością, dużą łatwością obróbki i polerowania.

Tener 350®

Partial denture alloy, Nickel free (Co-Cr) super hard
Stop kobaltowo-chromowy (Co-Cr) do odlewania protez szkieletowych (super lejnny), bezniklowy
Pack of 1kg.
Opak. zawiera 1 kg.

Typical chemical elements in % / Skład chemiczny %

Co	Cr	Mo	Mn	Al	Si	W	Fe	C
~65	29	6	0,6	<0,4	0,4	1	<1	0,3

Technical and physical data / Dane techniczno-fizyczne

Hardness after casting Twardość po odlewie	Ca.360 HV 10
Casting temperature Temperatura topienia	ca. 1,450
Solidus temperature Temperatura twardnienia	1340 °C
Liquidus temperature Temperatura krzepnięcia	1370 °C
Density Gęstość	8,3 g / cm
Modulus of elasticity Sprężystość	230,00
Size and weight of ingot Rozmiar i waga kostki	Ø 8 x 14,5 mm / ~6g

Tener 350 is an extremely pure cast alloy on cobalt base, exclusively made of fresh and pre-tested ore. This is an important requirement for high histocompatibility.

Highest mechanical features and best cast ability make room for individual and esthetical denture creation. Simple elaboration as well as good polishing and gloss results are typical.

Tener 350 (super lejnny) jest stopem do odlewania protez szkieletowych na bazie kobaltu, który jest produkowany wyłącznie ze sprawdzonych kruszców.

Charakteryzuje się dobrą leżnością, dużą łatwością obróbki i polerowania.

Tener IT®

Partial denture alloy, Nickel free (Co-Cr) reduced hardness
Stop kobaltowo-chromowy (Co-Cr) do odlewania struktur metalowych protez szkieletowych, bezniklowy
Pack of 1kg.
Opak. zawiera 1 kg.

Pack of 1kg.
Opak. zawiera 1 kg.

Typical chemical elements in % / Skład chemiczny %

Co	Cr	Mo	Mn	Al	Si	W	Fe	C
~65	29	6	0,6	<0,4	0,4	1	<1	0,15

Technical and physical data / Dane techniczno-fizyczne

Hardness after casting Twardość po odlewie	Ca.330 HV 10
Casting temperature Temperatura topienia	ca. 1,450
Solidus temperature Temperatura twardnienia	1340 °C
Liquidus temperature Temperatura krzepnięcia	1370 °C
Density Gęstość	8,3 g / cm
Modulus of elasticity Sprężystość	230,00
Size and weight of ingot Rozmiar i waga kostki	Ø 8 x 14,5 mm / ~6g

Tener IT is an extremely pure cast alloy on cobalt base, exclusively made of fresh and pre-tested ore. This is an important requirement for high histocompatibility.

Highest mechanical features and best cast ability make room for individual and esthetical denture creation. Simple elaboration as well as good polishing and gloss results are typical.

Tener IT (super lejnny) jest stopem do odlewania protez szkieletowych na bazie kobaltu, który jest produkowany wyłącznie ze sprawdzonych kruszców.

Charakteryzuje się dobrą leżnością, dużą łatwością obróbki i polerowania.

Aluminium compress & Laboratory flask / Ramka i puszka polimeryzacyjna



DL.1100.00



DL.1100.01

Articulators / Artykulatory



Falcon Deluxe
DL.050.000

DL.050.000
contents / zawiera:
1 x Articulator Unit
10 x Mounting plates (DL.050.001)
2 x Complete magnetic plates (DL.050.002)
10 x Cast fastening washers (DL.050.003)

1 x Artykulator
10 x Płytek montażowych (DL.050.001)
2 x Kompletnie płytki magnetyczne (DL.050.002)
10 x Płytek do modeli gipsowych (DL.050.003)

Articulators / Artykulatory



Falcon Deluxe
DL.051.000

Key / Klucz

DL.051.000
contents / zawiera:
1 x Articulator Unit
2 x Mounting plates (DL.050.001)

1 x Artykulator
2 x Płytek montażowych (DL.050.001)

Accessories / Akcesoria

Complete magnetic plate
Kompletna płytka magnetyczna

Magnet
Magnes



DL.050.002



DL.050.004

Mounting plates
Płytki montażowe do artykulatora

Cast fastening washers
Płytki do modeli gipsowych



DL.050.001
Pack of 10 pieces
Opak. zawiera 10 szt.



DL.050.003
Pack of 10 pieces
Opak. zawiera 10 szt.

Complete magnetic plate
Kompletna płytka magnetyczna

Cast fastening washers
Płytki do modeli gipsowych

Magnet
Magnes



DL.045.001



DL.045.002
Pack of 10 pieces
Opak. zawiera 10 szt.



DL.038.004

Articulators / Artykulatory



Falcon
DL.040.000

DL.040.000
contents / zawiera:
1 x Articulator Unit
2 x Mounting plates (DL.050.001)

1 x Artykulator
2 x Płytki montażowe (DL.050.001)

Articulators / Artykulatory



Plasterless articulator
Artykulator bezgipsowy
DL.060.000

Articulators / Artykulatory



Deluxe magnetic
DL.038.000

DL.038.000
contents / zawiera:
1 x Articulator Unit
2 x Complete magnetic plates (DL.038.002)
2 x Cast fastening washers (DL.038.003)
2 x Spare Pins

1 x Artykulator
2 x Kompletne płytki magnetyczne (DL.038.002)
2 x Płytek do modeli gipsowych (DL.038.003)
2 x Haczyki do artykulatora



Articulators / Artykulatory



Deluxe
DL.039.000

DL.039.001
Spare Pins (pair)
Haczyki do artykulatora (para)

Articulators / Artykulatory



Falcon
DL.045.000

DL.045.000
contents / zawiera:
1 x Articulator Unit
2 x Complete magnetic plates (DL.045.001)
10 x Cast fastening washers (DL.045.002)

1 x Artykulator
2 x Kompletne płytki magnetyczne (DL.045.001)
10 x Płytek do modeli gipsowych (DL.045.002)

Articulators / Artykulatory

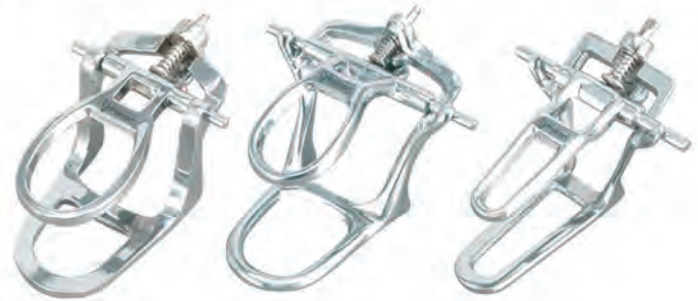

Fig. 50
DL.025.050
Full arch
Protezy

Fig. 51
DL.025.051
Full denture
Protezy

Fig. 57
DL.025.057
Crown & bridge
Korony i mosty

Fox ruler / Płytki Foxa do okluzji



BIO.1.18A
Fox ruler aluminium / Płytki Foxa aluminiowa

BIO.1.18P
Fox ruler polymer / Płytki Foxa plastikowa

Colored articulators / Artykulatory kolorowe



Fig. 50
Full arch
Protezy

Fig. 51
Full denture
Protezy

Fig. 57
Crown & bridge
Korony i mosty

	Fig.50	Fig.51	Fig.57
Black / Czarny	DL.026.150	DL.026.151	DL.026.157
Blue / Niebieski	DL.026.250	DL.026.251	DL.026.257
Red / Czerwony	DL.026.550	DL.026.551	DL.026.557
Yellow / Żółty	DL.026.850	DL.026.851	DL.026.857

Brass articulators / Artykulatory z miedzi



Fig. 50
DL.024.050
Full arch
Protezy

Fig. 51
DL.024.051
Full denture
Protezy

Fig. 57
DL.024.057
Crown & bridge
Korony i mosty

Accessories for articulators/ Akcesoria do artykulatorów



BIO.1.13
Complete magnetic mounting plate
Kompletna płytka magnetyczna montażowa



BIO.1.20
Rail mounting plate (Pack of 2 pieces)
Płytki do artykulatora, montażowe (para)



BIO.1.14
Cast fastening washers
Płytki do modeli gipsowych
Pack of 10 pieces
Opak. zawiera 10 szt.



BIO.1.15
Mounting plates
Płytki montażowe do artykulatora
Pair / Para



BIO.1.12
Incisal table (acrylic)
Stolik sieczny (montażowy)



BIO.1.16
Fork support
Wspornik do widelca



BIO.1.19
Camper's plan
Płytko Campera



BIO.1.17
Fork for toothless patients
Widelec do bezzębia



BIO.1.11
Adjustable incisal table
Nastawialny stolik sieczny

Occlusor / Zwierak

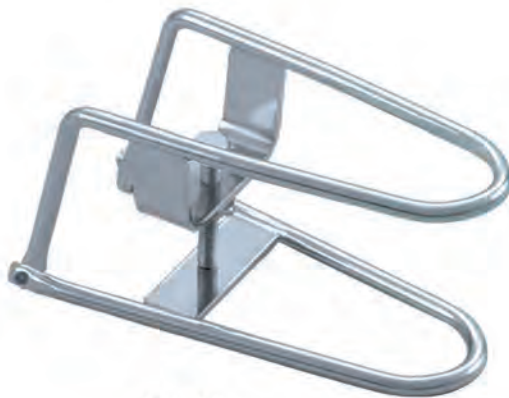

DL.027.000

Glass alcohol lamp / Szklany palnik spirytusowy



DL.009.000



DL.019.010
L=120 mm, ø 5mm
Wicks (pack of 5 pieces)
Knoty (opak. 5 szt.)

Alcohol lamp standard / Palnik spirytusowy standardowy



DL.010.000



DL.019.010
L=120 mm, ø 5mm
Wicks (pack of 5 pieces)
Knoty (opak. 5 szt.)

Alcohol lamps deluxe / Palniki spirytusowe deluxe



DL.015.010
Small / Mały
DL.015.020
Large / Duży

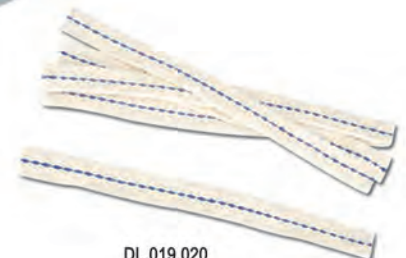

DL.019.020
L=100 mm, W=15 mm
Wicks (pack of 5 pieces)
Knoty (opak. 5 szt.)

Micro torches / Palniki gazowe

- Instant electronic ignition
- Precise adjustable flame
- Temperatures up to 2450°F/1343°C
- Elektryczny zapłon.
- Dokładna regulacja płomienia
- Temperatura do 1343°C



DL.1000.00
Hand held or free standing
Do użycia ręcznego lub wolnostojący

Excel burner with safety switch

This burner is high quality standard with stylish design and features with a stopper safety mechanism. It provides stable flame and a gas control knob to give you the control of flame size. Metal gas tank allows refilling in any time. Even just end a long time working. Design and Made in Taiwan

Features

- Refillable metal fuel tank
- Adjustable flame
- Heavy base design
- Good for continuous working
- Electronic instant ignition system
- Refillable 30 grams butane fuel tank
- With built in safety pressure release valve
- Minimum of 35 minutes use on each filling depending on the large flame setting, 95 minutes on the small flame setting



DL.1010.00



Calipers / Grubościomierze

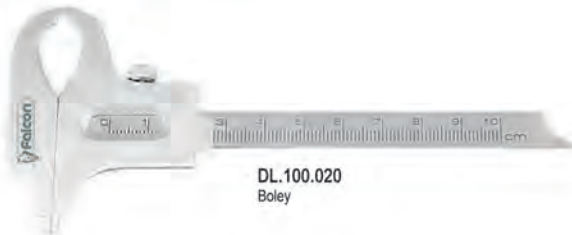

DL.100.020
Boley

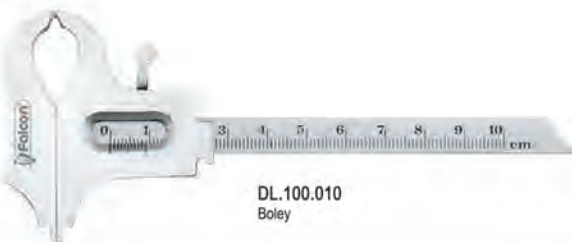

DL.100.010
Boley



Iwanson
For metal / Do metalu

DL.101.010
Standard

DL.101.030
Deluxe
Laser marked / Laserowo nacinane wymiary



Iwanson
For wax / Do wosku

DL.101.020
Standard

DL.101.040
Deluxe
Laser marked / Laserowo nacinane wymiary

Crown grippers / Kleszcze do koron

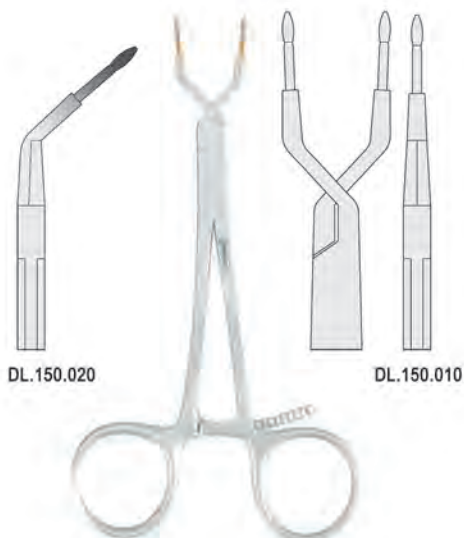

DL.150.020

DL.150.010

Crown scissors / Nożyczki do koron

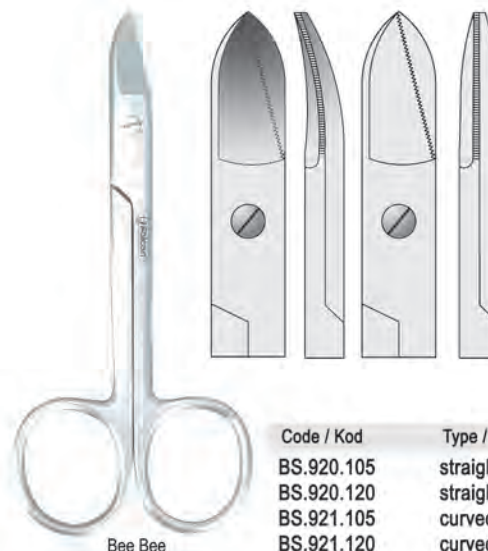

Bee Bee

Code / Kod	Type / Typ	Size / Długość
BS.920.105	straight / prosty	105mm
BS.920.120	straight / prosty	120mm
BS.921.105	curved / zagięte	105mm
BS.921.120	curved / zagięte	120mm

Riveting mallets / Młotki protetyczne



Fig. 1
DL.255.010
220 mm



Fig. 2
DL.255.020
220 mm

Soldering tweezers / Pensety protetyczne



DL.780.010
160 mm



DL.780.020
160 mm

Furnace tongs / Szczypce do pierścieni odlewniczych



DL.700.310
310 mm



DL.705.400
400 mm



DL.715.560
560 mm

Denture cases / Pudełka protetyczne



DL.9080.01
Maxi
Assorted colors
Assortment
Pack of 10 pieces
Opak. 10 szt.



DL.9080.02
Midi
Assorted colors
Assortment
Pack of 10 pieces
Opak. 10 szt.



DL.9080.03
Zestaw do przechowywania i pielęgnacji protez zębowych, ruchomych aparatów ortodontycznych, szyn retencyjnych, szyn relaksacyjnych
Ilość: 1x pudełko, 1x szczoteczka, 1x lusterko

Waterproof, lockable prosthesis box

For storage and cleaning of prosthesis
Waterproof due to special locking
Holds 2 prostheses and approx. 80 ml of liquid
Also suitable for storage of removable braces
Box contains double-sided cleaning brush, white bristles for basic surfaces, black bristles for prosthesis grooves
Brush compartment also for cleaning tablets
With mirror in the lid

Anvil / Kowadełko protetyczne



DL.020.010
L 110 x W 30 x H 40 mm
Carbon steel / Stal węglowa

Crown and bridge holding forceps
Kleszcze do trzymania koron i mostów



DL.154.020
125 mm
with support ring / z pierścieniem

Furnace tweezers / Pensety protetyczne



DL.790.200 200 mm
DL.790.300 300 mm

Plaster cutters / Kleszcze do gipsu



DL.325.200 Straight / Proste 200 mm
DL.326.200 Curved / Zagięte 200 mm

Fret saw and blades / Kabłącznica i brzeszczoty



DL.650.000
250 mm

DL.650.011 for metal / do metalu each / sztuka

DL.650.021 for plaster / do gipsu each / sztuka

Modeling saw and blades / Piłka protetyczna i brzeszczoty



DL.655.000
180 mm

DL.655.011 0.25 x 3 mm each / sztuka

DL.655.021 0.25 x 5 mm each / sztuka

DL.655.031 0.12 x 5 mm each / sztuka

Bowls for plaster and alginate / Miseczki do gipsu i masy



Silicone, flexible
Silikonowe, giętkie



Polyethylene, rigid
Z polietylenu, sztywne

Code / Kod	Size / Rozmiar
DL.500.011	ø 100 mm
DL.500.021	ø 120 mm
DL.500.031	ø 140 mm
DL.500.041	ø 160 mm

Code / Kod	Size / Rozmiar
DL.500.017	ø 100 mm
DL.500.027	ø 120 mm
DL.500.037	ø 140 mm

each / sztuka

Code / Kod	Size / Rozmiar
DL.502.010	ø 30 x 23 mm
DL.502.020	ø 49 x 40 mm
DL.502.030	ø 67 x 56 mm



Silicone mixing bowls
Miseczka silikonowa

Plaster knives with bakelite handle / Noże do gipsu, bakelitowy uchwyt



Fig.1
DL.332.010
Falcon
180 mm



Fig.2
DL.337.160
Gritman
160 mm



Fig.3
DL.337.170
Gritman
170 mm

Plaster knives with wooden handle
Noże do gipsu, drewniany uchwyt



Fig.1
DL.330.010
Falcon
180 mm



Fig.2
DL.335.160
Gritman
160 mm



Fig.3
DL.335.170
Gritman
170 mm



DL.340.180
Sacks
180 mm



Fig.1
DL.350.010
Falcon
170 mm



Fig.1A
DL.350.011
Falcon
180 mm



Fig.2A
DL.350.021
Falcon
140 mm



Fig.3
DL.350.030
Falcon
160 mm



Fig.4
DL.350.040
Falcon
160 mm



Fig.5
DL.350.050
Falcon
135 mm



Fig.6
DL.350.060
Falcon
135 mm

Plaster knives with colored plywood handle
Noże do gipsu, kolorowy drewniany uchwyt



Fig.1
DL.331.010
Falcon
180 mm



Fig.2
DL.336.160
Gritman
160 mm



Fig.3
DL.336.170
Gritman
170 mm



Fig.5
DL.351.050
Falcon
135 mm



Fig.6
DL.351.060
Falcon
135 mm

Plaster spatulae flexible / Łopatki do gipsu giętkie



Fig. 3
DL.450.030
Falcon
190 mm



Fig. 4
DL.450.040
Falcon
200 mm



Fig. 5
DL.450.050
Falcon
215 mm



Fig. 6
DL.450.060
Falcon
210 mm



Fig. 7
DL.450.070
Falcon
210 mm

Plaster spatulae rigid / Łopatki do gipsu sztywne



Fig. 1
DL.400.010
Falcon
185 mm

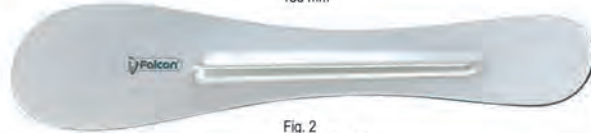

Fig. 2
DL.400.020
Falcon
180 mm



DL.410.170
Lichtenstein
170 mm



DL.415.200
Roghe
200 mm



Fig. 8
DL.450.080
Falcon
210 mm



Fig. 9
DL.450.090
Falcon
230 mm

Alginate spatulae / Łopatki do alginatu



185 mm

	Blue / Niebieska	DL.461.010
	Green / Zielona	DL.461.020
	Orange / Pomarańczowa	DL.461.030
	Pink / Różowa	DL.461.040
	Red / Czerwona	DL.461.050
	White / Biała	DL.461.060
	Yellow / Żółta	DL.461.070



Alginate spatula flexible / Łopatka do alginatu giętka



DL.460.010
Falcon
190 mm

Wax knives with plastic handle
Noże do wosku, plastikowy uchwyt

Non-autoclavable
Nie można sterylizować w autoklawie



	Black / Czarny	Fahnenstock 130 mm	Fahnenstock 175 mm
	Blue / Niebieski	DL.815.050	DL.815.060
	Green / Zielony	DL.815.051	DL.815.061
	Red / Czerwony	DL.815.052	DL.815.062
	White / Biały	DL.815.053	DL.815.063
	Yellow / Żółty	DL.815.054	DL.815.064
		DL.815.055	DL.815.065

Wax knives with plastic handle
Noże do wosku, plastikowy uchwyt

Non-autoclavable
Nie można sterylizować w autoklawie



	Black / Czarny	Lessmann 130 mm	Lessmann 175 mm
	Blue / Niebieski	DL.825.050	DL.825.060
	Green / Zielony	DL.825.051	DL.825.061
	Red / Czerwony	DL.825.052	DL.825.062
	White / Biały	DL.825.053	DL.825.063
	Yellow / Żółty	DL.825.054	DL.825.064
		DL.825.055	DL.825.065

Wax knives with wooden handle
Noże do wosku, drewniany uchwyt

	DL.805.010	con scodellino / z łyżeczką	130 mm
	DL.805.020	con scodellino / z łyżeczką	175 mm
	DL.815.010	Fahnenstock	130 mm
	DL.815.020	Fahnenstock	175 mm
	DL.825.010	Lessmann	130 mm
	DL.825.020	Lessmann	175 mm

Wax knives Ermert
Noże do wosku Ermert

	DL.810.010	Wooden handle / Drewniany uchwyt	130 mm
	DL.810.030	Plastic handle / Plastikowy uchwyt	130 mm
	DL.810.020	Metal handle / Metalowy uchwyt	130 mm

**Wax knives with bakelite handle
Noże do wosku, bakelitowy uchwyt**

 Autoclavable
Możliwość sterylizacji w autoklawie

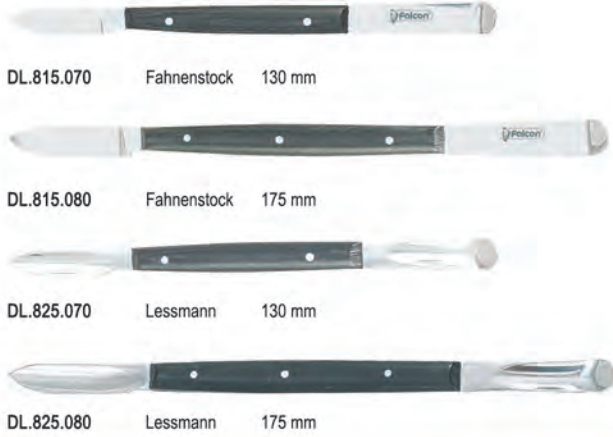

**Wax knives with metal handle
Noże do wosku, metalowy uchwyt**

 Autoclavable
Możliwość sterylizacji w autoklawie



Ceramic sculpturing instruments / Instrumenty do modelowania porcelany

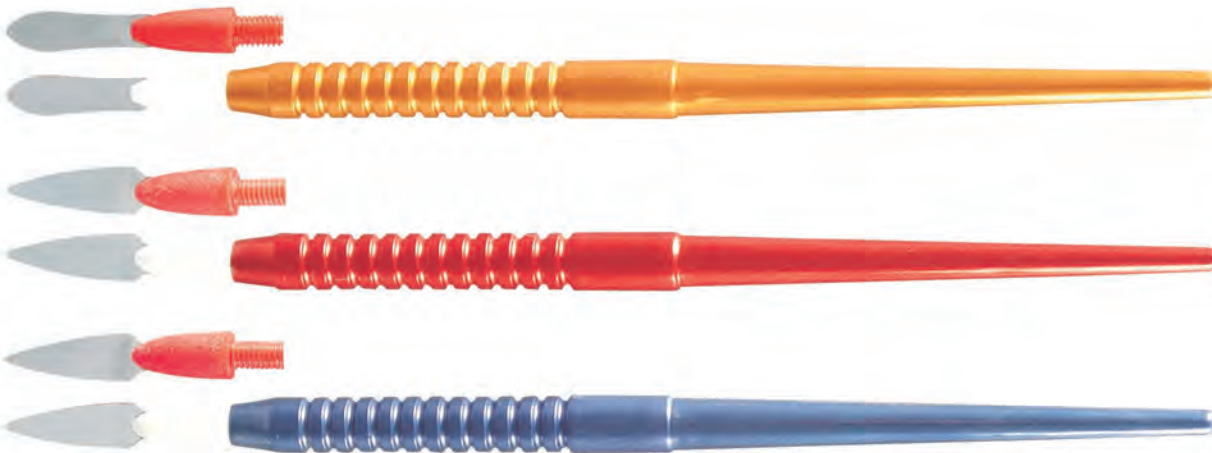

Fig. 1
DL.950.010

Fig. 2
DL.950.020

Fig. 3
DL.950.030
Knife / Nóż



DL.950.000
Set of 3 pieces / Zestaw zawiera 3 szt.



DL.955.000
Set of 3 pieces / Zestaw zawiera 3 szt.

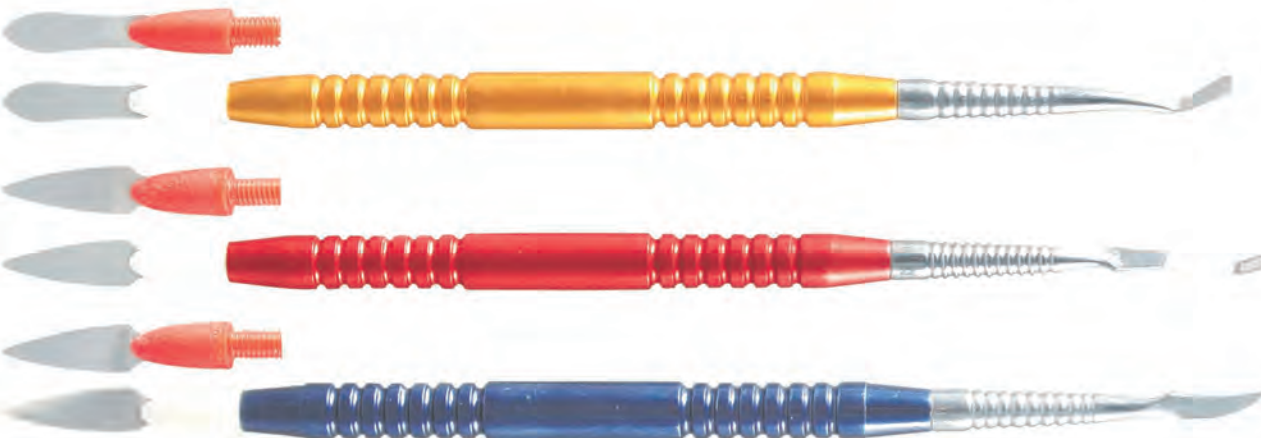

Fig. 1
DL.955.010

Fig. 2
DL.955.020

Fig. 3
DL.955.030
Knife / Nóż

Tips / Wymienne końcówki



Fig. 1 DL.949.010



Fig. 2 DL.949.020

Flexible / Giętkie



Fig. 3 DL.949.030
Knife / Nóż

Super flexible / Bardzo giętkie



Fig. 1 DL.949.011



Fig. 2 DL.949.021



Fig. 3 DL.949.031
Knife / Nóż

Modeling carvers / Instrumenty do modelowania

Aluminum handle / Uchwyt aluminiowy



Fig. 1 DL.905.010



Fig. 2 DL.905.020



Fig. 3 DL.905.030



Fig. 4 DL.905.040



Fig. 5 DL.905.050



DL.905.000
Set of 5 pieces / Zestaw zawiera 5 szt.



DL.904.000
Set of 5 pieces / Zestaw zawiera 5 szt.



Fig. 1 DL.904.010



Fig. 2 DL.904.020



Fig. 3 DL.904.030

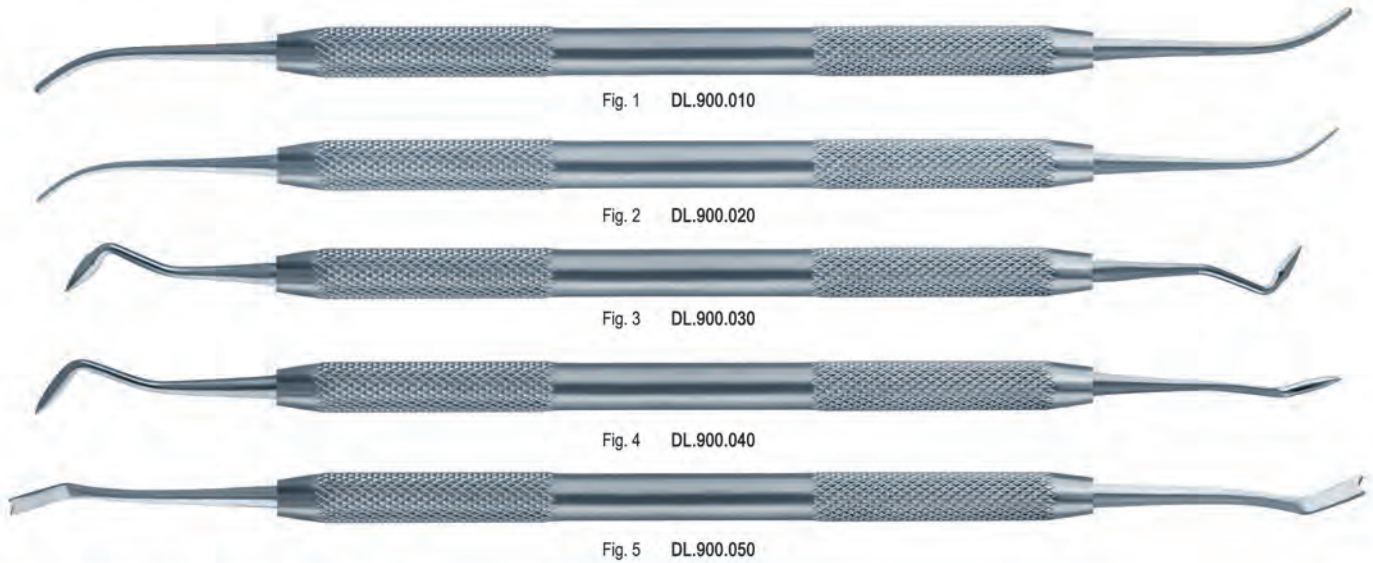

Fig. 4 DL.904.040



Fig. 5 DL.904.050

Modeling carvers / Instrumenty do modelowania



DL.900.000
Set of 5 pieces / Zestaw zawiera 5 szt.

Serie-UNO
Economical laboratory instruments
Instrumenty protetyczne w atrakcyjnej cenie

Pack of 5 pieces / Opak. 5 szt.

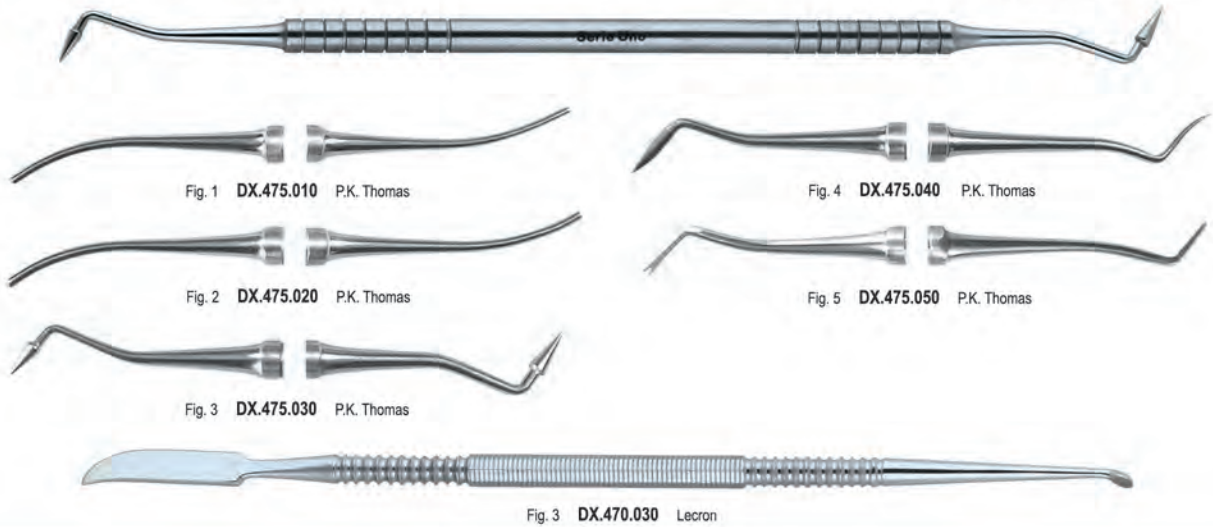

Modeling carvers
Nożyki do modelowania

Aluminum handle / Uchwyt aluminiowy

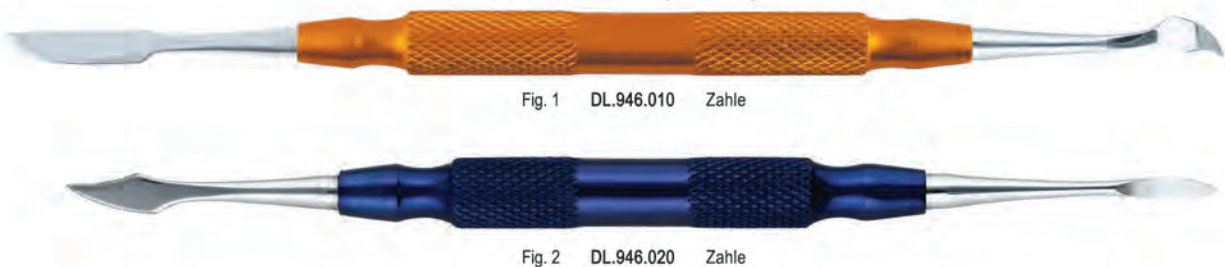

Modeling carvers and spatulae / Instrumenty do modelowania



Fig. 7 DL.856.070 Beale



Fig. 31 DL.870.314 Gritman



Fig. 10 DL.880.100 Lecron



Fig. 10 DL.875.100 Hylin



Fig. 10 DL.945.100 Zahle



Fig. 1 DL.932.010 Vehe



Fig. 31 DL.870.310 Gritman



Fig. 13 DL.864.130 Falcon



Fig. 1 DL.855.010 Beale



Fig. 12 DL.864.120 Falcon



Fig. 1 DL.918.010 Roach

Laboratory instruments kit for students / Zestaw instrumentów protetyczne dla studentów



Set contents

- DL.100.010 Gauge Boley with lever lock
- DL.825.010 Wax knife Lessmann small with wooden handle 130mm
- DL.825.020 Wax knife Lessmann regular with wooden handle 175mm
- DL.870.314 Soft-Line wax spatula Gritman fig. 31
- DL.875.010 Wax carver Hylin 135mm fig.1
- DL.875.050 Wax carver Hylin-Falcon 135mm fig.5
- DL.875.060 Wax carver Hylin-Lecron 135mm fig.6
- DL.880.010 Wax carver Lecron 165mm fig.1
- DL.900.010 Modelling Instrument P.K. Thomas fig. 1
- DL.900.020 Modelling Instrument P.K. Thomas fig. 2
- DL.900.030 Modelling Instrument P.K. Thomas fig. 3
- DL.900.040 Modelling Instrument P.K. Thomas fig. 4
- DL.900.050 Modelling Instrument P.K. Thomas fig. 5
- DL.945.030 Wax carver Zahle 125mm fig.3

Zestaw zawiera

- DL.100.010 Grubościomierz Boley
- DL.825.010 Nóż do wosku Lessmann mały, uchwyt drewniany 130mm
- DL.825.020 Nóż do wosku Lessmann duży, uchwyt drewniany 175mm
- DL.870.314 Soft-Line Łopatka do wosku Gritman fig.31
- DL.875.010 Nożyk do wosku Hylin 135mm fig.1
- DL.875.050 Nożyk do wosku Hylin-Falcon 135mm fig.5
- DL.875.060 Nożyk do wosku Hylin-Lecron 135mm fig.6
- DL.880.010 Nożyk do wosku Lecron 165mm fig.1
- DL.900.010 Instrument do modelowania P.K. Thomas fig. 1
- DL.900.020 Instrument do modelowania P.K. Thomas fig. 2
- DL.900.030 Instrument do modelowania P.K. Thomas fig. 3
- DL.900.040 Instrument do modelowania P.K. Thomas fig. 4
- DL.900.050 Instrument do modelowania P.K. Thomas fig. 5
- DL.945.030 Nożyk do wosku Zahle 125mm fig.3

Modeling carvers / Nożyki do modelowania

Fig. 1	Fig. 2	Fig. 3	Fig. 4	Fig. 5	Fig. 6	Fig. 7	Fig. 1	Fig. 2	Fig. 3	Fig. 4	Fig. 5	Fig. 6
DL.864.010	DL.864.020	DL.864.030	DL.864.040	DL.864.050	DL.864.060	DL.864.070	DL.945.010	DL.945.020	DL.945.030	DL.945.040	DL.945.050	DL.945.060
Falcon	Falcon	Falcon	Falcon	Falcon	Falcon	Falcon	Zahle	Zahle	Zahle	Zahle	Zahle	Zahle
130 mm	140 mm	140 mm	135 mm	140 mm	117 mm	115 mm	120 mm	125 mm	125 mm	120 mm	120 mm	115 mm



Fig. 1	Fig. 3	Fig. 5	Fig. 6	Fig. 1	Fig. 2	Fig. 3	Fig. 1	Fig. 2	Fig. 3	Fig. 4	Fig. 7	Fig. 8
DL.875.010	DL.875.030	DL.875.050	DL.875.060	DL.882.010	DL.882.020	DL.882.030	DL.880.010	DL.880.020	DL.880.030	DL.880.040	DL.880.070	DL.880.080
Hylin	Hylin-Ceramica	Hylin-Falcon	Hylin-Lecron	Lecron-Mini	Lecron-Mini	Lecron-Mini	Lecron	Lecron	Lecron	Lecron	Lecron	Lecron
135 mm	135 mm	135 mm	135 mm	100 mm	130 mm	130 mm	165 mm	165 mm	165 mm	165 mm	160 mm	160 mm

D14

Orthodontics / Ortodoncja



Smart Slide I

Self-ligating bracket system / Zamki samoligaturujące

Smart slide self Ligating are passive Self Ligating brackets system. The easy sliding door make the ligating much easier. To change one set of archwires can take less than one minute and passive mechanical design can provide the lowest friction. Free slide SL brackets make the orthodontic treatment easy and affective.

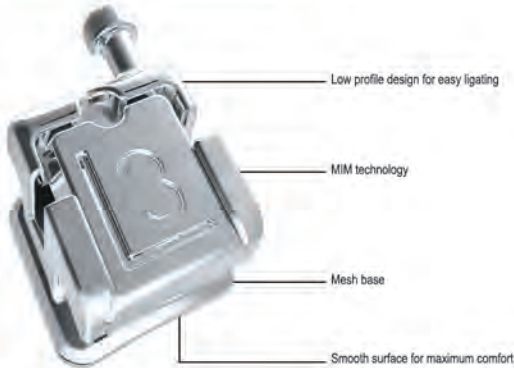

Single patient kits, 20 pieces / Zestawy dla 1 pacjenta, 20 sztuk.

Type / Typ	Hook / Haczyk	Roth / Rotha
		Slot .022"
5 x 5	on 3 / na 3	DO.0019.01

Clever M

Self-ligating bracket system / Zamki samoligaturujące

It's made of hard 17-4 stainless steel metal, MIM advanced technology. Newest aesthetic design metal brackets, with Interactive Self-Ligating Clip, Contoured appearance for maximum comfort!

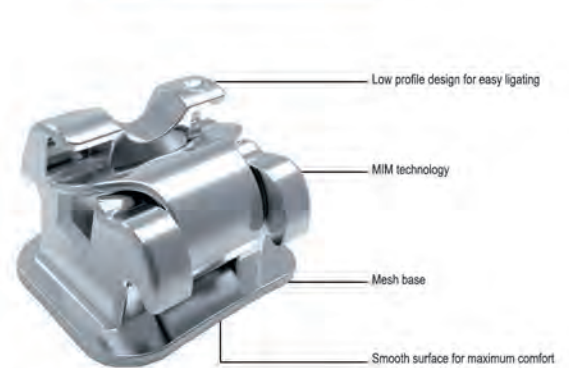

Single patient kits, 20 pieces / Zestawy dla 1 pacjenta, 20 sztuk.

Type / Typ	Hook / Haczyk	Roth / Rotha
		Slot .022"
5 x 5	on 3 / na 3	DO.0018.01

Smart Slide II

Self-ligating bracket system / Zamki samoligaturujące

Smart slide II self Ligating are passive Self Ligating brackets system. The easy sliding door make the ligating much easier. To change one set of archwires can take less than one minute and passive mechanical design can provide the lowest friction. Free slide SL brackets make the orthodontic treatment easy and affective.



2nd molar
na drugi trzonowiec

1st molar
na pierwszy trzonowiec



1 x Upper left / Góra lewa
1 x Upper right / Góra prawa
1 x Lower left / Dół lewa
1 x Lower right / Dół prawa

1 x Upper left / Góra lewa
1 x Upper right / Góra prawa
1 x Lower left / Dół lewa
1 x Lower right / Dół prawa

Roth Series

Torque: -7° Tip: 0°	Torque: -7° Tip: 0°	Torque: -2° Tip: 8°	Torque: +8° Tip: 8°	Torque: +12° Tip: 4°	Torque: +12° Tip: 4°	Torque: +8° Tip: 8°	Torque: -2° Tip: 8°	Torque: -7° Tip: 0°	Torque: -7° Tip: 0°
15	14	13	12	11	21	22	23	24	25
Torque: -22° Tip: 0°	Torque: -17° Tip: 0°	Torque: -11° Tip: 3°	Torque: -2° Tip: 0°	Torque: -2° Tip: 0°	Torque: -2° Tip: 0°	Torque: -2° Tip: 0°	Torque: -11° Tip: 3°	Torque: -17° Tip: 0°	Torque: -22° Tip: 0°
45	44	43	42	41	31	32	33	34	35

MBT Series

Torque: -11° Tip: 2°	Torque: -11° Tip: 2°	Torque: +7° Tip: 5°	Torque: +6° Tip: 9°	Torque: +15° Tip: 3°	Torque: +15° Tip: 5°	Torque: +6° Tip: 9°	Torque: +7° Tip: 5°	Torque: -11° Tip: 2°	Torque: -11° Tip: 2°
15	14	13	12	11	21	22	23	24	25
Torque: -17° Tip: 4°	Torque: -12° Tip: 4°	Torque: +7° Tip: 5°	Torque: -3° Tip: 2°	Torque: -3° Tip: 2°	Torque: -3° Tip: 2°	Torque: -3° Tip: 2°	Torque: +7° Tip: 5°	Torque: -12° Tip: 4°	Torque: -17° Tip: 4°
45	44	43	42	41	31	32	33	34	35

Type / Typ	Hook / Haczyk	Roth / Rotha	MBT / MBT
		Slot .022"	Slot .022"
7 x 7	on 3,4,5 / na 3,4,5	DO.0029.03	DO.0069.03

DISGUISE

Lingual bracket system / Zamki lingwalne

Lingual brackets are our second generation invisible lingual orthodontic treatment. Ling-2 system is made with CNC technology and hard stainless steel metal. Ling-2 brackets are most effective Lingual brackets system in the market and need professional skill to operate.

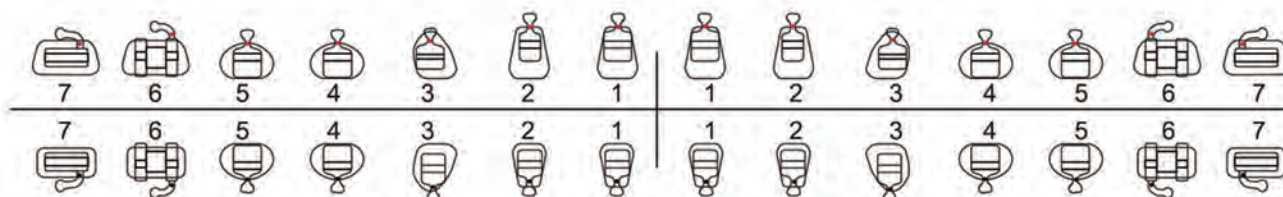

Single patient kits, 28 pieces / Zestawy dla 1 pacjenta, 28 sztuk.

Type / Typ	Hook / Haczyk	Edgewise	
		Slot .018"	Slot .022"
7 x 7	X	DO.1808.00	DO.1818.00

Diamond series

Two-piece Casted Bracket system, 80 gauge foil mesh bonding base
Zamki z dwóch kawałków metalu, posiadają podstawę z siateczką, która zapewni maksymalną siłę wiązania

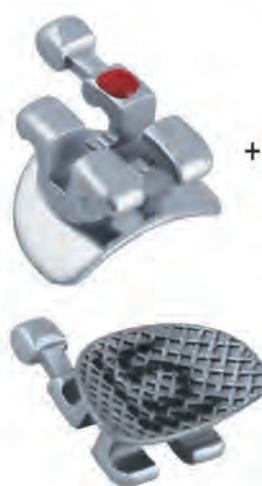

2nd molar
na drugi trzonowiec



1st molar
na pierwszy trzonowiec



1 x Upper left / Góra lewa
1 x Upper right / Góra prawa
1 x Lower left / Dół lewa
1 x Lower right / Dół prawa

1 x Upper left / Góra lewa
1 x Upper right / Góra prawa
1 x Lower left / Dół lewa
1 x Lower right / Dół prawa



Single patient kits, 28 pieces / Zestawy dla 1 pacjenta, 28 sztuk.

Type / Typ	Hook / Haczyk	Roth
		Slot .022"
7 x 7	on 3 / na 3	DO.0719.01

MINI GEM

Two-piece Casted Bracket system, 80 gauge foil mesh bonding base
Zamki z dwóch kawałków metalu, posiadają podstawę z siateczką, która zapewnia maksymalną siłę wiązania

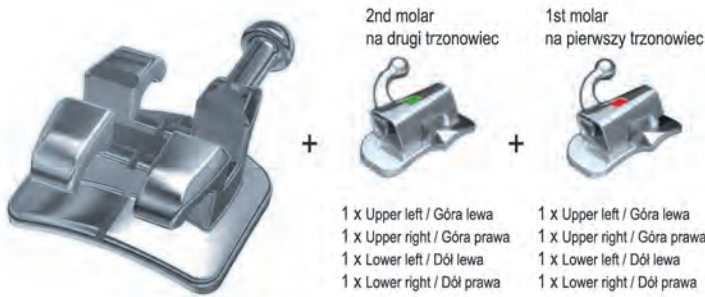

Single patient kits, 28 pieces / Zestawy dla 1 pacjenta, 28 sztuk.

Type Typ	Hook Haczyk	Roth Slot .022"	MBT Slot .022"
7 x 7	3	DO.0319.01	DO.0369.01



MINI GEM

Two-piece Casted Bracket system, 80 gauge foil mesh bonding base
Zamki z dwóch kawałków metalu, posiadają podstawę z siateczką, która zapewnia maksymalną siłę wiązania



Single patient kits, 20 pieces / Zestawy dla 1 pacjenta, 20 sztuk.

Type Typ	Hook Haczyk	Roth Slot .018"	Slot .022"
5 x 5	x	DO.0308.00	DO.0318.00
5 x 5	3	DO.0308.01	DO.0318.01
5 x 5	3,4,5	DO.0308.03	DO.0318.03



Roth System / System Rotha

Each / Sztuka

Maxillary Szczeka	Torque Tork	Angle Angulacja	Width (mm) Szerokość	In / Out mm	.018"	.022"
UR 1	+12°	+5°	3.0	0.6	DO.0300.10	DO.0310.10
UL 1					DO.0301.10	DO.0310.20
UR 2	+8°	+9°	2.6	1.1	DO.0300.20	DO.0311.10
UL 2					DO.0301.20	DO.0311.20
UR 3	-2°	+13°	2.8	0.6	DO.0300.30	DO.0310.30
UL 3					DO.0301.30	DO.0311.30
UR 3 (hook / haczyk)	-2°	+13°	2.8	0.6	DO.0300.31	DO.0310.31
UL 3 (hook / haczyk)					DO.0301.31	DO.0311.31
UR 4/5	-7°	0°	2.6	0.6	DO.0300.40	DO.0310.40
UL 4/5					DO.0301.40	DO.0311.40
UR 4/5 (hook / haczyk)	-7°	0°	2.6	0.6	DO.0300.41	DO.0310.41
UL 4/5 (hook / haczyk)					DO.0301.41	DO.0311.41

Each / Sztuka

Mandibular Żuchwa	Torque Tork	Angle Angulacja	Width (mm) Szerokość	In / Out mm	.018"	.022"
Universal 1/2	-1°	0°	2.4	1.0	DO.0303.10	DO.0313.10
LR 3	-11°	+7°	2.8	0.6	DO.0303.30	DO.0313.30
LL 3					DO.0304.30	DO.0314.30
LR 3 (hook / haczyk)	-11°	+7°	2.8	0.6	DO.0303.31	DO.0313.31
LL 3 (hook / haczyk)					DO.0304.31	DO.0314.31
LR 4	-17°	0°	2.6	0.6	DO.0303.40	DO.0313.40
LL 4					DO.0304.40	DO.0314.40
LR 4 (hook / haczyk)	-17°	0°	2.6	0.6	DO.0303.41	DO.0313.41
LL 4 (hook / haczyk)					DO.0304.41	DO.0314.41
LR 5	-22°	0°	2.6	0.6	DO.0303.50	DO.0313.50
LL 5					DO.0304.50	DO.0314.50
LR 5 (hook / haczyk)	-22°	0°	2.6	0.6	DO.0303.51	DO.0313.51
LL 5 (hook / haczyk)					DO.0304.51	DO.0314.51

Falcon's version of Roth is not implied to be an exact version of any other system, nor do we claim any endorsement of Dr. Roth.

MINI GEM

Two-piece Casted Bracket system, 80 gauge foil mesh bonding base
Zamki z dwóch kawałków metalu, posiadają podstawę z siateczką,
która zapewnia maksymalną siłę wiązania



Edgewise System / System Edgewise

Each / Sztuka

Maxillary Szczeka	Torque Tork	Angle Angulacja	Width (mm) Szerokość	In / Out mm	.018"	.022"
Universal 1	0°	0°	3.0	0.65	DO.0330.10	DO.0340.10
Universal 2	0°	0°	2.6	0.65	DO.0330.20	DO.0340.20
Universal 3	0°	0°	2.6	0.65	DO.0330.30	DO.0340.30
UR 3 (hook / haczyk) UL 3 (hook / haczyk)	0°	0°	2.6	0.65	DO.0330.31 DO.0331.31	DO.0340.31 DO.0341.31
Universal 4/5	0°	0°	2.6	0.65	DO.0330.40	DO.0340.40
UR 4/5 (hook / haczyk) UL 4/5 (hook / haczyk)	0°	0°	2.6	0.65	DO.0330.41 DO.0331.41	DO.0340.41 DO.0341.41

MINI GEM

Two-piece Casted Bracket system, 80 gauge foil mesh bonding base
Zamki z dwóch kawałków metalu, posiadają podstawę z siateczką,
która zapewnia maksymalną siłę wiązania



Mclaughlin, Bennett and Trevisi System

Each / Sztuka

	Torque Tork	Angle Angulacja	Width (mm) Szerokość	In / Out mm	.018"	.022"
● UR 1 ● Maxillary ● Szczeka	+17°	+4°	3.4	0.6	DO.0350.10 DO.0351.10	DO.0360.10 DO.0361.10
● UL 2	+17°	+4°	2.8	1.0	DO.0350.20	DO.0360.20
● UR 3 ● UL 3	+10°	+8°	3.0	0.5	DO.0351.30 DO.0351.30	DO.0361.30 DO.0361.30
● UR 3 (hook / haczyk) ● UL 3 (hook / haczyk)	+10°	+8°	3.0	0.5	DO.0350.31 DO.0351.31	DO.0360.31 DO.0361.31
● UR 4/5 ● UL 4/5	-7°	0°	2.8	0.6	DO.0350.40 DO.0351.40	DO.0360.40 DO.0361.40
● UR 4/5 (hook / haczyk) ● UL 4/5 (hook / haczyk)	-7°	0°	2.8	0.6	DO.0350.41 DO.0351.41	DO.0360.41 DO.0361.41

Falcon's version of Mclaughlin, Bennett and Trevisi System is not implied to be an exact version of any other system, nor do we claim any endorsement of the doctors.



Single patient kits, 20 pieces / Zestawy dla 1 pacjenta, 20 sztuk.

Type Typ	Hook Haczyk	Edgewise	
		Slot .018"	Slot .022"
5 x 5	x	DO.0338.00	DO.0348.00
5 x 5	3	DO.0338.01	DO.0348.01
5 x 5	3,4,5	DO.0338.03	DO.0348.03

Mandibular Żuchwa	Torque Tork	Angle Angulacja	Width (mm) Szerokość	In / Out mm	.018"	.022"
Universal ½	-1°	0°	2.4	1.0	DO.0333.10	DO.0343.10
Universal 3	-11°	+7°	2.8	0.6	DO.0333.30	DO.0343.30
LR 3 (hook / haczyk) LL 3 (hook / haczyk)	-11°	+7°	2.8	0.6	DO.0333.31 DO.0334.31	DO.0343.31 DO.0344.31
Universal 4/5	-17°	0°	2.6	0.6	DO.0333.40	DO.0343.40
LR 4/5 (hook / haczyk) LL 4/5 (hook / haczyk)	17°	0°	2.6	0.6	DO.0333.41 DO.0334.41	DO.0343.41 DO.0344.41



Single patient kits, 20 pieces / Zestawy dla 1 pacjenta, 20 sztuk.

Type Typ	Hook Haczyk	MBT	
		Slot .018"	Slot .022"
5 x 5	x	DO.0358.00	DO.0368.00
5 x 5	3	DO.0358.01	DO.0368.01
5 x 5	3,4,5	DO.0358.03	DO.0368.03

Mandibular Żuchwa	Torque Tork	Angle Angulacja	Width (mm) Szerokość	In / Out mm	.018"	.022"
● Universal ½	-6°	0°	2.4	1.0	DO.0353.10	DO.0363.10
● LR 3 ● LL 3	-6°	+3°	3.0	0.5	DO.0353.30 DO.0354.30	DO.0363.30 DO.0364.30
● LR 3 (hook / haczyk) ● LL 3 (hook / haczyk)	-6°	+3°	3.0	0.5	DO.0353.31 DO.0354.31	DO.0363.31 DO.0364.31
● LR 4 ● LL 4	-11°	0°	2.8	0.5	DO.0353.40 DO.0354.40	DO.0363.40 DO.0364.40
● LR 4 (hook / haczyk) ● LL 4 (hook / haczyk)	-11°	0°	2.8	0.5	DO.0353.41 DO.0354.41	DO.0363.41 DO.0364.41
● LR 5 ● LL 5	-16°	0°	2.8	0.5	DO.0353.50 DO.0354.50	DO.0363.50 DO.0364.50
● LR 5 (hook / haczyk) ● LL 5 (hook / haczyk)	-16°	0°	2.8	0.5	DO.0353.51 DO.0354.51	DO.0363.51 DO.0364.51

MARK I

One piece MIM bracket system
Zamki z jednego kawałka metalu
Wykonane metodą wtryskową MIM



Type / Typ	Hook / Haczyk	Roth / Rotha	
		Slot .018"	Slot .022"
5 x 5	3	D0.0108.01	D0.0118.01
5 x 5	3, 4, 5	D0.0108.03	D0.0118.03



MARK II

Two piece bracket system, laser welded
z dwóch kawałków metalu
Zgrzewane laserowo



Single patient kits, 20 pieces / Zestawy dla 1 pacjenta, 20 sztuk.

Type / Typ	Hook / Haczyk	Roth / Rotha	
		Slot .018"	Slot .022"
5 x 5	3	D0.0208.01	D0.0218.01
5 x 5	3, 4, 5	D0.0208.03	D0.0218.03





One piece MIM, twin design bracket system
Zamki Twin MIM z jednego kawałka metalu



Metal injection molded (MIM)

One piece, metal injection molded from high grade stainless steel alloy.

Highly resistant to corrosion

Mesh bonding pad

Provides maximum retention

Ultra low profile

For added patient comfort

Torque-in-base

Metal Injection Molded (MIM)

Zamki z jednego kawałka najwyższego

jakościowo metalu wykonane metodą wtryskową

MIM. Niezwykle odporne na korozję.

Podstawa pokryta siateczką

Zapewniona maksymalna retencja

Bardzo niski profil

Dla polepszenia komfortu pacjenta

Tork w podstawie

each / sztuka



System Roth / System Rotha

Turbo II brackets are also available in following perscriptions on special orders / Zamki Turbo II są dostępne w następujących systemach na specjalne zamówienie
Roth 'V' Slot, Ricketts/Hilgers, standard Edgewise and MBT

Maxillary / Szczęka		Torque Tork	Angle Angulacja	Width(mm) Szerokość	Slot .018"	Slot .022"
	Right / Yellow Prawa / Żółty	1	+12°	+5°	3.5	D0.0500.10
	Left / Red Lewa / Czerwony	1				
Centrals Siekacze centralne						
	Right / Yellow Prawa / Żółty	2	+8°	+9°	3.0	D0.0500.20
	Left / Red Lewa / Czerwony	2				
Laterals Siekacze boczne						
	Right / Yellow Prawa / Żółty	3	+0°	+11°	3.5	D0.0500.31
	Left / Red Lewa / Czerwony	3				
Cuspids with hooks Kły z haczykiem						
	Right / Yellow Prawa / Żółty	3	+0°	+11°	3.5	D0.0500.30
	Left / Red Lewa / Czerwony	3				
Cuspids Kły						
	Right / Yellow Prawa / Żółty	5, 4	-7°	0°	3.0	D0.0500.41
	Left / Red Lewa / Czerwony	4, 5				
Bicuspid with hooks Przedtrzonowce z haczykiem						
	Right / Yellow Prawa / Żółty	5, 4	-7°	0°	3.0	D0.0500.40
	Left / Red Lewa / Czerwony	4, 5				
Bicuspid Przedtrzonowce						

The above version of Roth is not implied to be an exact version of any other system, nor do we claim any endorsement of Dr. Roth.

Mandibular / Żuchwa		Torque Tork	Angle Angulacja	Width(mm) Szerokość	Slot .018"	Slot .022"
	Universal Uniwersalna	FDI 31, 32, 41, 42 2, 1	0°	0°	2.5	D0.0503.10
Anteriors Siekacze						
	Right / Black Prawa / Czarny	3	-11°	+5°	3.0	D0.0503.31
	Left / Blue Lewa / Niebieski	3				
Cuspids with hooks Kły z haczykiem						
	Right / Black Prawa / Czarny	3	-11°	+5°	3.0	D0.0503.30
	Left / Blue Lewa / Niebieski	3				
Cuspids Kły						
	Right / Black Prawa / Czarny	4	-17°	0°	3.0	D0.0503.41
	Left / Blue Lewa / Niebieski	4				
1st Bicuspid with hooks Przedtrzonowce z haczykiem 1						
	Right / Black Prawa / Czarny	4	-17°	0°	3.0	D0.0503.40
	Left / Blue Lewa / Niebieski	4				
1st Bicuspid Przedtrzonowce 1						
	Right / Black Prawa / Czarny	5	-22°	0°	3.0	D0.0503.51
	Left / Blue Lewa / Niebieski	5				
2nd Bicuspid with hooks Przedtrzonowce z haczykiem 2						
	Right / Black Prawa / Czarny	5	-22°	0°	3.0	D0.0503.50
	Left / Blue Lewa / Niebieski	5				
2nd Bicuspid Przedtrzonowce 2						

Single patient kits, 20 pieces / Zestawy dla 1 pacjenta, 20 sztuk.

Type / Typ	Hook / Haczyk	Roth / Rotha	
		Slot .018"	Slot .022"
5 x 5	x	D0.0508.00	D0.0518.00
5 x 5	3	D0.0508.01	D0.0518.01
5 x 5	3, 4, 5	D0.0508.03	D0.0518.03





CERAMIKA-I

Ceramic bracket system / Zamki ceramiczne



Single patient kits, 20 pieces / Zestawy dla 1 pacjenta, 20 sztuk.

Type / Typ	Hook / Haczyk	Roth / Rotha		MBT / MBT	
		Slot .018"	Slot .022"	Slot .018"	Slot .022"
5 x 5	3	DO.1008.01	DO.1018.01	DO.1009.01	DO.1019.01
5 x 5	3, 4, 5	DO.1008.03	DO.1018.03	DO.1009.03	DO.1019.03



CERAMIKA-II

Ceramic bracket system / Zamki ceramiczne



Single patient kits, 20 pieces / Zestawy dla 1 pacjenta, 20 sztuk.

Type / Typ	Hook / Haczyk	Roth / Rotha		MBT / MBT	
		Slot .018"	Slot .022"	Slot .018"	Slot .022"
5 x 5	3	DO.1108.01	DO.1118.01	DO.1109.01	DO.1119.01
5 x 5	3, 4, 5	DO.1108.03	DO.1118.03	DO.1109.03	DO.1119.03



CERAMIKA-III

Ceramic bracket system with nickel free metal slot
Zamki ceramiczne z metalowym slotem bez niklu



Single patient kits, 20 pieces / Zestawy dla 1 pacjenta, 20 sztuk.

Type / Typ	Hook / Haczyk	Roth / Rotha	
		Slot .018"	Slot .022"
5 x 5	3	DO.1308.01	DO.1318.01

AQUA

Transparent aesthetic bracket system
Zamki kosmetyczne transparentne



Single patient kits, 20 pieces / Zestawy dla 1 pacjenta, 20 sztuk.

Type / Typ	Hook / Haczyk	Roth / Rotha	
		Slot .018"	Slot .022"
5 x 5	3	DO.1408.01	DO.1418.01
5 x 5	3, 4, 5	DO.1408.03	DO.1418.03



DO.1992.00
Brackets organizer for 20 sets
Organizer na zamki, na 20 zestawów



Ceramika

CERAMIC BRACKET SYSTEM

Ceramic bracket system Zamki ceramiczne

- Made of 99.9% pure Polycrystalline Alumina
- Smooth slot design for improved sliding mechanism
- Resistant to slot-wear and fracturing
- Resistant to staining or discoloration
- Bonds and debonds like metal brackets
- Najwyższej jakości materiał 99,9% glinki polikrystalicznej
- Redukcja tarcia dzięki gładkiemu wykończeniu slotu
- Zamki o wyjątkowej wytrzymałości, odporne na uszkodzenia, pęknięcia oraz zużycie się slotu
- Odporne na przebarwienia oraz zmianę koloru
- Przyklejają się i odklejają jak zamki metalowe



Identification System



Roth System / System Rotha

each / sztuka

Maxillary / Szczeka		Torque Tork	Angle Angulacja	Width(mm) Szerokość	Slot .018"	Slot .022"
Right / Orange Prawa / Pomarańczowy	1 FDI 11	+12°	+5°	3.9	DO.1200.10	DO.1210.10
Left / Orange Lewa / Pomarańczowy	1 FDI 21	+12°	+5°	3.9	DO.1201.10	DO.1211.10
Right / Green Prawa / Zielony	2 FDI 12	+8°	+9°	3.4	DO.1200.20	DO.1210.20
Left / Green Lewa / Zielony	2 FDI 22	+8°	+9°	3.4	DO.1201.20	DO.1211.20
Right / Red Prawa / Czerwony	3 FDI 13	+0°	+11°	3.4	DO.1200.31	DO.1210.31
Left / Red Lewa / Czerwony	3 FDI 23	+0°	+11°	3.4	DO.1201.31	DO.1211.31
Right / Red Prawa / Czerwony	3 FDI 13	+0°	+11°	3.4	DO.1200.30	DO.1210.30
Left / Red Lewa / Czerwony	3 FDI 23	+0°	+11°	3.4	DO.1201.30	DO.1211.30
Universal / Blue Uniwersalna / Niebieski	5, 4 4, 5 FDI 14, 15, 24, 25	-7°	0°	3.3	DO.1200.41	DO.1210.41
Universal / Blue Uniwersalna / Niebieski	5, 4 4, 5 FDI 14, 15, 24, 25	-7°	0°	3.3	DO.1200.40	DO.1210.40

The above version of Roth is not implied to be an exact version of any other system, nor do we claim any endorsement of Dr. Roth.

each / sztuka

Mandibular / Żuchwa		Torque Tork	Angle Angulacja	Width(mm) Szerokość	Slot .022"	
Universal Uniwersalna	FDI 31,32,41,42 2,1 1,2	0°	0°	2.8	DO.1203.10	DO.1213.10
Right / Yellow Prawa / Żółty	FDI 43 3	-11°	+5°	3.4	DO.1203.31	DO.1213.31
Left / Yellow Lewa / Żółty	FDI 33 3	-11°	+5°	3.4	DO.1204.31	DO.1214.31
Right / Yellow Prawa / Żółty	FDI 43 3	-11°	+5°	3.4	DO.1203.30	DO.1213.30
Left / Yellow Lewa / Żółty	FDI 33 3	-11°	+5°	3.4	DO.1204.30	DO.1214.30
Universal / Brown Uniwersalna / Brązowy	FDI 34,44 4 4	-17°	0°	3.4	DO.1203.41	DO.1213.41
Universal / Brown Uniwersalna / Brązowy	FDI 34,44 4 4	-17°	0°	3.4	DO.1203.40	DO.1213.40
Universal / Black Uniwersalna / Czarny	FDI 35,45 5 5	-22°	0°	3.4	DO.1203.51	DO.1213.51
Universal / Black Uniwersalna / Czarny	FDI 35,45 5 5	-22°	0°	3.4	DO.1203.50	DO.1213.50

Single patient kits, 20 pieces / Zestawy dla 1 pacjenta, 20 sztuk.

Type / Typ	Hook / Haczyk	Roth / Rotha	
		Slot .018"	Slot .022"
5 x 5	x	DO.1208.00	DO.1218.00
5 x 5	3	DO.1208.01	DO.1218.01
5 x 5	3, 4, 5	DO.1208.03	DO.1218.03





RAV COMPOSITE BRACKET SYSTEM



Composite bracket system Zamki kompozytowe

- Made of high quality composite
- Smooth slot design for improved sliding mechanism
- Resistant to slot-wear and fracturing
- Resistant to staining or discoloration
- Bonds and debonds like metal brackets
- Also available in Standard Edgewise system, please ask for details

- Zamki wykonane z wysokiej jakości kompozytu
- Redukcja tarcia dzięki gładkiemu wykończeniu slotu
- Zamki o wyjątkowej wytrzymałości, odporne na uszkodzenia, pęknięcia oraz zużycie się slotu
- Odporne na przebarwienia oraz zmianę koloru
- Przyklejają się i odklejają jak zamki metalowe
- Dostępne również w wersji Standard Edgewise



Roth System / System Rotha

Maxillary / Szczęka		Torque Tork	Angle Angulacja	Width(mm) Szerokość	Slot .018"	Slot .022"
 Right / Black Prawa / Czarny FDI 11	Centrals Stekacze centralne	+12°	+5°	3.6	DO.0800.10	DO.0810.10
 Left / Black Lewa / Czarny FDI 21		+12°	+5°	3.6	DO.0801.10	DO.0811.10
 Right / Red Prawa / Czerwony FDI 12	Laterals Stekacze boczne	+8°	+9°	3.2	DO.0800.20	DO.0810.20
 Left / Red Lewa / Czerwony FDI 22		+8°	+9°	3.2	DO.0801.20	DO.0811.20
 Right / Green Prawa / Zielony FDI 13	Cuspids with hooks Kły z haczykiem	0°	+11°	3.5	DO.0800.31	DO.0810.31
 Left / Green Lewa / Zielony FDI 23		0°	+11°	3.5	DO.0801.31	DO.0811.31
 Right / Orange Prawa / Pomarańczowy FDI 14, 15	Bicuspids with hooks Przedtrzonowce z haczykiem	-7°	0°	3.2	DO.0800.41	DO.0810.41
 Left / Orange Lewa / Pomarańczowy FDI 24, 25		-7°	0°	3.2	DO.0801.41	DO.0811.41

The above version of Roth is not implied to be an exact version of any other system, nor do we claim any endorsement of Dr. Roth.



Mandibular / Żuchwa		Torque Tork	Angle Angulacja	Width(mm) Szerokość	Slot .018"	Slot .022"
 Universal / Yellow Uniwersalna / Żółty FDI 31, 32, 41, 42 2,1 1,2	Anteriors Stekacze	0°	0°	3.0	DO.0803.10	DO.0813.10
 Right / Purple Prawa / Fiolet FDI 43 3	Cuspids with hooks Kły z haczykiem	-11°	+5°	3.5	DO.0803.31	DO.0813.31
 Left / Purple Lewa / Fiolet FDI 33 3		-11°	+5°	3.5	DO.0804.31	DO.0814.31
 Right / Brown Prawa / Brązowy FDI 44 4	1st Bicuspids with hooks Przedtrzonowce z haczykiem 1	-17°	0°	3.2	DO.0803.41	DO.0813.41
 Left / Brown Lewa / Brązowy FDI 34 4		-17°	0°	3.2	DO.0804.41	DO.0814.41
 Right / Navy blue Prawa / Granatowy FDI 45 5	2nd Bicuspids with hooks Przedtrzonowce z haczykiem 2	-22°	0°	3.2	DO.0803.51	DO.0813.51
 Left / Navy blue Lewa / Granatowy FDI 35 5		-22°	0°	3.2	DO.0804.51	DO.0814.51



Single patient kits, 20 pieces / Zestawy dla 1 pacjenta, 20 sztuk.

Type / Typ	Hook / Haczyk	Roth / Rotha	
		Slot .018"	Slot .022"
5 x 5	3, 4, 5	DO.0808.03	DO.0818.03

Stackable brackets organizer Kaseta do zamków



DO.1995.00
with 4 disposable bonding trays with mixing wells
z 4 jednorazowe podstawki do zamków z miejscem do mieszania

Komposito

COMPOSITE BRACKET SYSTEM

Composite bracket system / Zamki kompozytowe

- Made of medical grade Polyurethane
- Smooth slot design for improved sliding mechanism
- Resistant to slot-wear and fracturing
- Resistant to staining or discoloration
- Bonds and debonds like metal brackets







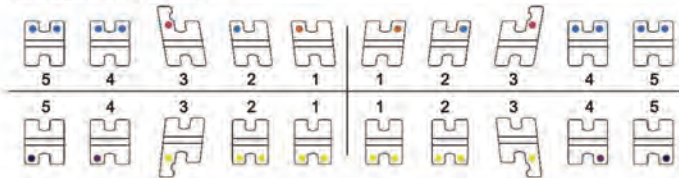





- Niezwykłą wytrzymałość zawdzięczają poliuretanowi
- Redukcja tarcia dzięki gładkiemu wykończeniu slotu
- Zamki o wyjątkowej wytrzymałości, odporne na uszkodzenia, pęknięcia oraz zużycie się slotu
- Odporne na przebarwienia oraz zmianę koloru
- Przyklejają się i odklejają jak zamki metalowe













each / sztuka



Roth System / System Rotha

Maxillary / Szczęka		Torque Tork	Angle Angulacja	Width(mm) Szerokość	Slot .018"	Slot .022"
	Right / Orange Prawa / Pomarańczowy	1	+12°	+5°	3.9	DO.0900.10
	Left / Orange Lewa / Pomarańczowy	1				
	Right / Green Prawa / Zielony	2	+8°	+9°	3.4	DO.0900.20
	Left / Green Lewa / Zielony	2				
	Right / Red Prawa / Czerwony	3	+0°	+11°	3.4	DO.0900.31
	Left / Red Lewa / Czerwony	3				
	Right / Red Prawa / Czerwony	3	+0°	+11°	3.4	DO.0900.30
	Left / Red Lewa / Czerwony	3				
	Universal / Blue Uniwersalna / Niebieski	5, 4 4, 5	-7°	0°	3.3	DO.0900.41
	Uniwersalna / Niebieski	FDI 14, 15, 24, 25				
	Universal / Blue Uniwersalna / Niebieski	5, 4 4, 5	-7°	0°	3.3	DO.0900.40
	Uniwersalna / Niebieski	FDI 14, 15, 24, 25				

The above version of Roth is not implied to be an exact version of any other system, nor do we claim any endorsement of Dr. Roth.

Mandibular / Żuchwa		Torque Tork	Angle Angulacja	Width(mm) Szerokość	Slot .018"	Slot .022"
	Universal / Brown Uniwersalna / Brązowy	FDI 31,32,41,42 2,1 1,2	0°	0°	2.8	DO.0903.10
	Right / Yellow Prawa / Żółty	FDI 43 3	-11°	+5°	3.4	DO.0903.31
	Left / Yellow Lewa / Żółty	FDI 33 3				
	Right / Yellow Prawa / Żółty	FDI 43 3	-11°	+5°	3.4	DO.0903.30
	Left / Yellow Lewa / Żółty	FDI 33 3				
	Universal / Brown Uniwersalna / Brązowy	FDI 34,44 4 4	-17°	0°	3.4	DO.0903.41
	Uniwersalna / Brązowy	FDI 34,44 4 4				
	Universal / Black Uniwersalna / Czarny	FDI 35,45 5 5	-22°	0°	3.4	DO.0903.51
	Uniwersalna / Czarny	FDI 35,45 5 5				
	Universal / Black Uniwersalna / Czarny	FDI 35,45 5 5	-22°	0°	3.4	DO.0903.50
	Uniwersalna / Czarny	FDI 35,45 5 5				

Single patient kits, 20 pieces / Zestawy dla 1 pacjenta, 20 sztuk.

Type / Typ	Hook / Haczyk	Roth / Rotha	
		Slot .018"	Slot .022"
5 x 5	x	DO.0908.00	DO.0918.00
5 x 5	3	DO.0908.01	DO.0918.01
5 x 5	3, 4, 5	DO.0908.03	DO.0918.03



Sure-Fit

Upper 1st Molar bands size chart



Sure-Fit	3M Unitek Victory Series	GAC-SnapFit	Dentaurum-Dentaform	Ortho Technology
x	x	x	x	30
x	x	x	x	30.5
31	31	3	8	31
31.5	31.5	4	x	31.5
32	32	5	9	32
32.5	32.5	6	10	32.5
33	33	7	11	33
33.5	33.5	8	12	33.5
34	34	9	13	34
34.5	34.5	10	14	34.5
35	35	11	16	35
35.5	35.5	12	17	35.5
36	36	13	18	36
36.5	36.5	14	19	36.5
37	37	15	x	x
37.5	37.5	16	22	x
38	38	17	23	x
38.5	38.5	18	24	x
39	39	19	25	x
39.5	39.5	20	27	x
40	40	21	x	x
40.5	40.5	22	28	x
41	41	23	x	x
41.5	41.5	24	32	x
42	42	25	x	x
42.5	42.5	26	x	x
43	43	27	x	x
43.5	43.5	28	x	x
44	44	29	x	x
44.5	44.5	30	x	x

Sure-Fit

Lower 1st Molar bands size chart



Sure-Fit	3M Unitek Victory Series	GAC-SnapFit	Dentaurum-Dentaform	Ortho Technology
30	30	x	x	30
30.5	30.5	2	x	30.5
31	31	x	8	31
31.5	31.5	x	x	31.5
32	32	x	9	32
32.5	32.5	x	10	32.5
33	33	x	11	33
33.5	33.5	x	12	33.5
34	34	x	13	34
34.5	34.5	x	14	34.5
35	35	x	16	35
35.5	35.5	7	17	35.5
36	36	8	18	36
36.5	36.5	9	19	36.5
37	37	15	x	x
37.5	37.5	16	22	x
38	38	17	23	x
38.5	38.5	18	24	x
39	39	19	25	x
39.5	39.5	20	27	x
40	40	21	x	x
40.5	40.5	22	28	x
41	41	23	x	x
41.5	41.5	24	32	x
42	42	25	x	x
42.5	42.5	26	x	x
43	43	27	x	x
43.5	43.5	28	x	x
x	x	29	x	x
x	x	30	x	x

Sure-Fit

1st Molar bands plain / Pierścienie gładkie na pierwsze trzonowce

each / sztuka

Anatomically shaped / Anatomiczny kształt pierścienia

Fast, placement and accurate fit

Umożliwia szybkie umiejscowienie i dokładne jego dopasowanie

Rounded edges / Zawinięte brzegi

No sharp edges for patient comfort

Gładko wykończone krawędzie zapewniają maksymalny komfort pacjenta

Micro-Etched interior surface / Mikrowytrawiona wewnętrzna powierzchnia

For increased bond strength

Zapewnia maksymalne utrzymanie

Ideally hardened stainless steel, for easy contouring

Doskonale zahartowanie materiału, z którego wykonane

są pierścienie ułatwia dopasowanie obwodu pierścienia do zęba

Permanent laser marking / Trwałe laserowe oznakowanie

For easy identification

Zapewnia łatwą identyfikację

Band Size / Rozmiar	Upper Left / Góra lewa	Upper Right / Góra prawa	Lower Left / Dół lewy	Lower Right / Dół prawy
30	x	x	DO.2020.04	DO.2030.04
30.5	x	x	DO.2020.05	DO.2030.05
31	DO.2000.06	DO.2010.06	DO.2020.06	DO.2030.06
31.5	DO.2000.07	DO.2010.07	DO.2020.07	DO.2030.07
32	DO.2000.08	DO.2010.08	DO.2020.08	DO.2030.08
32.5	DO.2000.09	DO.2010.09	DO.2020.09	DO.2030.09
33	DO.2000.10	DO.2010.10	DO.2020.10	DO.2030.10
33.5	DO.2000.11	DO.2010.11	DO.2020.11	DO.2030.11
34	DO.2000.12	DO.2010.12	DO.2020.12	DO.2030.12
34.5	DO.2000.13	DO.2010.13	DO.2020.13	DO.2030.13
35	DO.2000.14	DO.2010.14	DO.2020.14	DO.2030.14
35.5	DO.2000.15	DO.2010.15	DO.2020.15	DO.2030.15
36	DO.2000.16	DO.2010.16	DO.2020.16	DO.2030.16
36.5	DO.2000.17	DO.2010.17	DO.2020.17	DO.2030.17
37	DO.2000.18	DO.2010.18	DO.2020.18	DO.2030.18
37.5	DO.2000.19	DO.2010.19	DO.2020.19	DO.2030.19
38	DO.2000.20	DO.2010.20	DO.2020.20	DO.2030.20
38.5	DO.2000.21	DO.2010.21	DO.2020.21	DO.2030.21
39	DO.2000.22	DO.2010.22	DO.2020.22	DO.2030.22
39.5	DO.2000.23	DO.2010.23	DO.2020.23	DO.2030.23
40	DO.2000.24	DO.2010.24	DO.2020.24	DO.2030.24
40.5	DO.2000.25	DO.2010.25	DO.2020.25	DO.2030.25
41	DO.2000.26	DO.2010.26	DO.2020.26	DO.2030.26
41.5	DO.2000.27	DO.2010.27	DO.2020.27	DO.2030.27
42	DO.2000.28	DO.2010.28	DO.2020.28	DO.2030.28
42.5	DO.2000.29	DO.2010.29	DO.2020.29	DO.2030.29
43	DO.2000.30	DO.2010.30	DO.2020.30	DO.2030.30
43.5	DO.2000.31	DO.2010.31	DO.2020.31	DO.2030.31
44	DO.2000.32	DO.2010.32	x	x
44.5	DO.2000.33	DO.2010.33	x	x

1st Molar bands kits

Custom made kits are available on special order

Buy 400 bands custom kit and get bands organizer Free

Zestawy pierścieni na pierwsze trzonowce

Zestawy również na indywidualne zamówienie

Przy zakupie 400 pierścieni otrzymasz organizer gratis.

Stackable bands organizer

Organizer do pierścieni

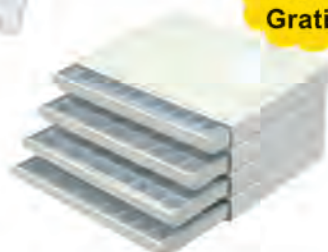

**Free
Gratis**



DO.2000.00
Set of 4 cassettes
Zestaw zawiera 4 kasety

Sure-Fit

1st Molar pre-welded bands

Pierścienie na pierwsze trzonowce z akcesoriami

Pre-welded bands offer convenience and time saving
Pierścienie uzbrojone są łatwiejsze w użyciu i oszczędzają czas

Available in variety of pre-welded options to fit any need
Dostępna duża różnorodność pierścieni, aby zaspokoić potrzeby pacjentów.

Maxillary / Szczeka

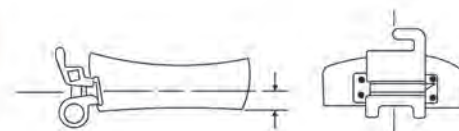

each / sztuka

Option 1 / Wersja 1



Band / Pierścień

Non-convertible single
buccal tube .022"

Niezamienna pojedyncza
rurka .022"

Lingual Cleat
Klit

Option 2 / Wersja 2



Band / Pierścień

Convertible double buccal tube,
occlusal headgear tube .022"

Rurka podwójna zamienna z tubą
do wyciągu zewnątrzstawnego od strony
płaszczyzny zgryzowej .022"

Lingual Cleat
Klit

Option 3 / Wersja 3



Band / Pierścień

Convertible triple buccal tube,
occlusal headgear tube .022"

Rurka potrójna zamienna z tubą
do wyciągu zewnątrzstawnego od
strony płaszczyzny zgryzowej .022"

Lingual Cleat
Klit

Left / Lewa		Right / Prawa	
LU31	DO.2001.06	RU31	DO.2011.06
LU31.5	DO.2001.07	RU31.5	DO.2011.07
LU32	DO.2001.08	RU32	DO.2011.08
LU32.5	DO.2001.09	RU32.5	DO.2011.09
LU33	DO.2001.10	RU33	DO.2011.10
LU33.5	DO.2001.11	RU33.5	DO.2011.11
LU34	DO.2001.12	RU34	DO.2011.12
LU34.5	DO.2001.13	RU34.5	DO.2011.13
LU35	DO.2001.14	RU35	DO.2011.14
LU35.5	DO.2001.15	RU35.5	DO.2011.15
LU36	DO.2001.16	RU36	DO.2011.16
LU36.5	DO.2001.17	RU36.5	DO.2011.17
LU37	DO.2001.18	RU37	DO.2011.18
LU37.5	DO.2001.19	RU37.5	DO.2011.19
LU38	DO.2001.20	RU38	DO.2011.20
LU38.5	DO.2001.21	RU38.5	DO.2011.21
LU39	DO.2001.22	RU39	DO.2011.22
LU39.5	DO.2001.23	RU39.5	DO.2011.23
LU40	DO.2001.24	RU40	DO.2011.24
LU40.5	DO.2001.25	RU40.5	DO.2011.25
LU41	DO.2001.26	RU41	DO.2011.26
LU41.5	DO.2001.27	RU41.5	DO.2011.27
LU42	DO.2001.28	RU42	DO.2011.28
LU42.5	DO.2001.29	RU42.5	DO.2011.29
LU43	DO.2001.30	RU43	DO.2011.30
LU43.5	DO.2001.31	RU43.5	DO.2011.31
LU44	DO.2001.32	RU44	DO.2011.32
LU44.5	DO.2001.33	RU44.5	DO.2011.33

Left / Lewa		Right / Prawa	
LU31	DO.2002.06	RU31	DO.2012.06
LU31.5	DO.2002.07	RU31.5	DO.2012.07
LU32	DO.2002.08	RU32	DO.2012.08
LU32.5	DO.2002.09	RU32.5	DO.2012.09
LU33	DO.2002.10	RU33	DO.2012.10
LU33.5	DO.2002.11	RU33.5	DO.2012.11
LU34	DO.2002.12	RU34	DO.2012.12
LU34.5	DO.2002.13	RU34.5	DO.2012.13
LU35	DO.2002.14	RU35	DO.2012.14
LU35.5	DO.2002.15	RU35.5	DO.2012.15
LU36	DO.2002.16	RU36	DO.2012.16
LU36.5	DO.2002.17	RU36.5	DO.2012.17
LU37	DO.2002.18	RU37	DO.2012.18
LU37.5	DO.2002.19	RU37.5	DO.2012.19
LU38	DO.2002.20	RU38	DO.2012.20
LU38.5	DO.2002.21	RU38.5	DO.2012.21
LU39	DO.2002.22	RU39	DO.2012.22
LU39.5	DO.2002.23	RU39.5	DO.2012.23
LU40	DO.2002.24	RU40	DO.2012.24
LU40.5	DO.2002.25	RU40.5	DO.2012.25
LU41	DO.2002.26	RU41	DO.2012.26
LU41.5	DO.2002.27	RU41.5	DO.2012.27
LU42	DO.2002.28	RU42	DO.2012.28
LU42.5	DO.2002.29	RU42.5	DO.2012.29
LU43	DO.2002.30	RU43	DO.2012.30
LU43.5	DO.2002.31	RU43.5	DO.2012.31
LU44	DO.2002.32	RU44	DO.2012.32
LU44.5	DO.2002.33	RU44.5	DO.2012.33

Left / Lewa		Right / Prawa	
LU31	DO.2003.06	RU31	DO.2013.06
LU31.5	DO.2003.07	RU31.5	DO.2013.07
LU32	DO.2003.08	RU32	DO.2013.08
LU32.5	DO.2003.09	RU32.5	DO.2013.09
LU33	DO.2003.10	RU33	DO.2013.10
LU33.5	DO.2003.11	RU33.5	DO.2013.11
LU34	DO.2003.12	RU34	DO.2013.12
LU34.5	DO.2003.13	RU34.5	DO.2013.13
LU35	DO.2003.14	RU35	DO.2013.14
LU35.5	DO.2003.15	RU35.5	DO.2013.15
LU36	DO.2003.16	RU36	DO.2013.16
LU36.5	DO.2003.17	RU36.5	DO.2013.17
LU37	DO.2003.18	RU37	DO.2013.18
LU37.5	DO.2003.19	RU37.5	DO.2013.19
LU38	DO.2003.20	RU38	DO.2013.20
LU38.5	DO.2003.21	RU38.5	DO.2013.21
LU39	DO.2003.22	RU39	DO.2013.22
LU39.5	DO.2003.23	RU39.5	DO.2013.23
LU40	DO.2003.24	RU40	DO.2013.24
LU40.5	DO.2003.25	RU40.5	DO.2013.25
LU41	DO.2003.26	RU41	DO.2013.26
LU41.5	DO.2003.27	RU41.5	DO.2013.27
LU42	DO.2003.28	RU42	DO.2013.28
LU42.5	DO.2003.29	RU42.5	DO.2013.29
LU43	DO.2003.30	RU43	DO.2013.30
LU43.5	DO.2003.31	RU43.5	DO.2013.31
LU44	DO.2003.32	RU44	DO.2013.32
LU44.5	DO.2003.33	RU44.5	DO.2013.33

1st Molar pre-welded bands kits

Custom made kits are available on special order
Buy 100 bands custom kit and get bands organizer Free

Zestawy pierścieni na pierwsze trzonowce z akcesoriami

Zestawy dostępne również na indywidualne zamówienie
Przy zakupie 100 pierścieni otrzymasz organizer gratis.



Sure-Fit

1st Molar pre-welded bands

Pierścienie na pierwsze trzonowce z akcesoriami i wejściem na łuk podniebny

Pre-welded bands offer convenience and time saving
Pierścienie uzbrojone są łatwiejsze w użyciu i oszczędzają czas

Available in variety of pre-welded options to fit any need
Dostępna duża różnorodność pierścieni, aby zaspokoić potrzeby pacjentów.

Maxillary / Szczęka

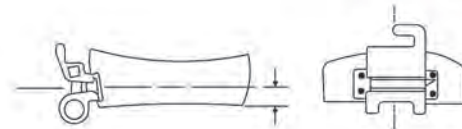

each / sztuka



Option 1.1 / Wersja 1.1



Band / Pierścień

Non-convertible single buccal tube .022"

Niezamienna pojedyncza rurka .022"

Lingual Sheath
Rurka językowa

Option 2.1 / Wersja 2.1



Band / Pierścień

Convertible double buccal tube, occlusal headgear tube .022"

Rurka podwójna zamienna z tubą do wyciągu zewnątrzustnego od strony płaszczyzny zgryzowej .022"

Lingual Sheath
Rurka językowa

Option 3.1 / Wersja 3.1



Band / Pierścień

Convertible triple buccal tube, occlusal headgear tube .022"

Rurka potrójna zamienna z tubą do wyciągu zewnątrzustnego od strony płaszczyzny zgryzowej .022"

Lingual Sheath
Rurka językowa

Left / Lewa		Right / Prawa	
LU31	DO.2061.06	RU31	DO.2071.06
LU31.5	DO.2061.07	RU31.5	DO.2071.07
LU32	DO.2061.08	RU32	DO.2071.08
LU32.5	DO.2061.09	RU32.5	DO.2071.09
LU33	DO.2061.10	RU33	DO.2071.10
LU33.5	DO.2061.11	RU33.5	DO.2071.11
LU34	DO.2061.12	RU34	DO.2071.12
LU34.5	DO.2061.13	RU34.5	DO.2071.13
LU35	DO.2061.14	RU35	DO.2071.14
LU35.5	DO.2061.15	RU35.5	DO.2071.15
LU36	DO.2061.16	RU36	DO.2071.16
LU36.5	DO.2061.17	RU36.5	DO.2071.17
LU37	DO.2061.18	RU37	DO.2071.18
LU37.5	DO.2061.19	RU37.5	DO.2071.19
LU38	DO.2061.20	RU38	DO.2071.20
LU38.5	DO.2061.21	RU38.5	DO.2071.21
LU39	DO.2061.22	RU39	DO.2071.22
LU39.5	DO.2061.23	RU39.5	DO.2071.23
LU40	DO.2061.24	RU40	DO.2071.24
LU40.5	DO.2061.25	RU40.5	DO.2071.25
LU41	DO.2061.26	RU41	DO.2071.26
LU41.5	DO.2061.27	RU41.5	DO.2071.27
LU42	DO.2061.28	RU42	DO.2071.28
LU42.5	DO.2061.29	RU42.5	DO.2071.29
LU43	DO.2061.30	RU43	DO.2071.30
LU43.5	DO.2061.31	RU43.5	DO.2071.31
LU44	DO.2061.32	RU44	DO.2071.32
LU44.5	DO.2061.33	RU44.5	DO.2071.33

Left / Lewa		Right / Prawa	
LU31	DO.2062.06	RU31	DO.2072.06
LU31.5	DO.2062.07	RU31.5	DO.2072.07
LU32	DO.2062.08	RU32	DO.2072.08
LU32.5	DO.2062.09	RU32.5	DO.2072.09
LU33	DO.2062.10	RU33	DO.2072.10
LU33.5	DO.2062.11	RU33.5	DO.2072.11
LU34	DO.2062.12	RU34	DO.2072.12
LU34.5	DO.2062.13	RU34.5	DO.2072.13
LU35	DO.2062.14	RU35	DO.2072.14
LU35.5	DO.2062.15	RU35.5	DO.2072.15
LU36	DO.2062.16	RU36	DO.2072.16
LU36.5	DO.2062.17	RU36.5	DO.2072.17
LU37	DO.2062.18	RU37	DO.2072.18
LU37.5	DO.2062.19	RU37.5	DO.2072.19
LU38	DO.2062.20	RU38	DO.2072.20
LU38.5	DO.2062.21	RU38.5	DO.2072.21
LU39	DO.2062.22	RU39	DO.2072.22
LU39.5	DO.2062.23	RU39.5	DO.2072.23
LU40	DO.2062.24	RU40	DO.2072.24
LU40.5	DO.2062.25	RU40.5	DO.2072.25
LU41	DO.2062.26	RU41	DO.2072.26
LU41.5	DO.2062.27	RU41.5	DO.2072.27
LU42	DO.2062.28	RU42	DO.2072.28
LU42.5	DO.2062.29	RU42.5	DO.2072.29
LU43	DO.2062.30	RU43	DO.2072.30
LU43.5	DO.2062.31	RU43.5	DO.2072.31
LU44	DO.2062.32	RU44	DO.2072.32
LU44.5	DO.2062.33	RU44.5	DO.2072.33

Left / Lewa		Right / Prawa	
LU31	DO.2063.06	RU31	DO.2073.06
LU31.5	DO.2063.07	RU31.5	DO.2073.07
LU32	DO.2063.08	RU32	DO.2073.08
LU32.5	DO.2063.09	RU32.5	DO.2073.09
LU33	DO.2063.10	RU33	DO.2073.10
LU33.5	DO.2063.11	RU33.5	DO.2073.11
LU34	DO.2063.12	RU34	DO.2073.12
LU34.5	DO.2063.13	RU34.5	DO.2073.13
LU35	DO.2063.14	RU35	DO.2073.14
LU35.5	DO.2063.15	RU35.5	DO.2073.15
LU36	DO.2063.16	RU36	DO.2073.16
LU36.5	DO.2063.17	RU36.5	DO.2073.17
LU37	DO.2063.18	RU37	DO.2073.18
LU37.5	DO.2063.19	RU37.5	DO.2073.19
LU38	DO.2063.20	RU38	DO.2073.20
LU38.5	DO.2063.21	RU38.5	DO.2073.21
LU39	DO.2063.22	RU39	DO.2073.22
LU39.5	DO.2063.23	RU39.5	DO.2073.23
LU40	DO.2063.24	RU40	DO.2073.24
LU40.5	DO.2063.25	RU40.5	DO.2073.25
LU41	DO.2063.26	RU41	DO.2073.26
LU41.5	DO.2063.27	RU41.5	DO.2073.27
LU42	DO.2063.28	RU42	DO.2073.28
LU42.5	DO.2063.29	RU42.5	DO.2073.29
LU43	DO.2063.30	RU43	DO.2073.30
LU43.5	DO.2063.31	RU43.5	DO.2073.31
LU44	DO.2063.32	RU44	DO.2073.32
LU44.5	DO.2063.33	RU44.5	DO.2073.33

1st Molar pre-welded bands kits

Custom made kits are available on special order
Buy 100 bands custom kit and get bands organizer Free

Zestawy pierścieni na pierwsze trzonowce z akcesoriami

Zestawy dostępne również na indywidualne zamówienie
Przy zakupie 100 pierścieni otrzymasz organizer gratis.

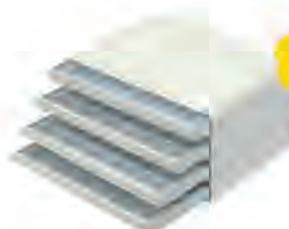

Free
Gratis

Sure-Fit

1st Molar pre-welded bands

Pierścienie na pierwsze trzonowce z akcesoriami

Pre-welded bands offer convenience and time saving
Pierścienie uzbrojone są łatwiejsze w użyciu i oszczędzają czas

Available in variety of pre-welded options to fit any need
Dostępna duża różnorodność pierścieni, aby zaspokoić potrzeby pacjentów.

Mandibular / Żuchwa

each / sztuka

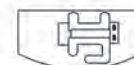
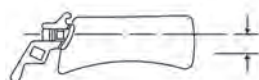

Option 1 / Wersja 1



Band / Pierścień

Non-convertible single buccal tube .022"

Niezamienna rurka pojedyncza .022"

Lingual Cleat Kit

Option 2 / Wersja 2



Band / Pierścień

Convertible single buccal tube .022"

Zamienna rurka pojedyncza .022"

Lingual Cleat Kit

Option 3 / Wersja 3



Band / Pierścień

Convertible double buccal tube .022"

Zamienna rurka podwójna .022"

Lingual Cleat Kit

Option 4 / Wersja 4



Band / Pierścień

Convertible double buccal tube, occlusal headgear tube .022"

Rurka podwójna zamienna z tubą do wyciągu zewnątrzustnego od strony płaszczyny zgryzowej .022"

Lingual Cleat Kit

Option 1 / Wersja 1

Option 2 / Wersja 2

Option 3 / Wersja 3

Option 4 / Wersja 4

Size / Rozmiar	Left / Lewa	Right / Prawa	Left / Lewa	Right / Prawa	Left / Lewa	Right / Prawa	Left / Lewa	Right / Prawa
LL30	DO.2021.04	DO.2031.04	DO.2022.04	DO.2032.04	DO.2023.04	DO.2033.04	DO.2024.04	DO.2034.04
LL30.5	DO.2021.05	DO.2031.05	DO.2022.05	DO.2032.05	DO.2023.05	DO.2033.05	DO.2024.05	DO.2034.05
LL31	DO.2021.06	DO.2031.06	DO.2022.06	DO.2032.06	DO.2023.06	DO.2033.06	DO.2024.06	DO.2034.06
LL31.5	DO.2021.07	DO.2031.07	DO.2022.07	DO.2032.07	DO.2023.07	DO.2033.07	DO.2024.07	DO.2034.07
LL32	DO.2021.08	DO.2031.08	DO.2022.08	DO.2032.08	DO.2023.08	DO.2033.08	DO.2024.08	DO.2034.08
LL32.5	DO.2021.09	DO.2031.09	DO.2022.09	DO.2032.09	DO.2023.09	DO.2033.09	DO.2024.09	DO.2034.09
LL33	DO.2021.10	DO.2031.10	DO.2022.10	DO.2032.10	DO.2023.10	DO.2033.10	DO.2024.10	DO.2034.10
LL33.5	DO.2021.11	DO.2031.11	DO.2022.11	DO.2032.11	DO.2023.11	DO.2033.11	DO.2024.11	DO.2034.11
LL34	DO.2021.12	DO.2031.12	DO.2022.12	DO.2032.12	DO.2023.12	DO.2033.12	DO.2024.12	DO.2034.12
LL34.5	DO.2021.13	DO.2031.13	DO.2022.13	DO.2032.13	DO.2023.13	DO.2033.13	DO.2024.13	DO.2034.13
LL35	DO.2021.14	DO.2031.14	DO.2022.14	DO.2032.14	DO.2023.14	DO.2033.14	DO.2024.14	DO.2034.14
LL35.5	DO.2021.15	DO.2031.15	DO.2022.15	DO.2032.15	DO.2023.15	DO.2033.15	DO.2024.15	DO.2034.15
LL36	DO.2021.16	DO.2031.16	DO.2022.16	DO.2032.16	DO.2023.16	DO.2033.16	DO.2024.16	DO.2034.16
LL36.5	DO.2021.17	DO.2031.17	DO.2022.17	DO.2032.17	DO.2023.17	DO.2033.17	DO.2024.17	DO.2034.17
LL37	DO.2021.18	DO.2031.18	DO.2022.18	DO.2032.18	DO.2023.18	DO.2033.18	DO.2024.18	DO.2034.18
LL37.5	DO.2021.19	DO.2031.19	DO.2022.19	DO.2032.19	DO.2023.19	DO.2033.19	DO.2024.19	DO.2034.19
LL38	DO.2021.20	DO.2031.20	DO.2022.20	DO.2032.20	DO.2023.20	DO.2033.20	DO.2024.20	DO.2034.20
LL38.5	DO.2021.21	DO.2031.21	DO.2022.21	DO.2032.21	DO.2023.21	DO.2033.21	DO.2024.21	DO.2034.21
LL39	DO.2021.22	DO.2031.22	DO.2022.22	DO.2032.22	DO.2023.22	DO.2033.22	DO.2024.22	DO.2034.22
LL39.5	DO.2021.23	DO.2031.23	DO.2022.23	DO.2032.23	DO.2023.23	DO.2033.23	DO.2024.23	DO.2034.23
LL40	DO.2021.24	DO.2031.24	DO.2022.24	DO.2032.24	DO.2023.24	DO.2033.24	DO.2024.24	DO.2034.24
LL40.5	DO.2021.25	DO.2031.25	DO.2022.25	DO.2032.25	DO.2023.25	DO.2033.25	DO.2024.25	DO.2034.25
LL41	DO.2021.26	DO.2031.26	DO.2022.26	DO.2032.26	DO.2023.26	DO.2033.26	DO.2024.26	DO.2034.26
LL41.5	DO.2021.27	DO.2031.27	DO.2022.27	DO.2032.27	DO.2023.27	DO.2033.27	DO.2024.27	DO.2034.27
LL42	DO.2021.28	DO.2031.28	DO.2022.28	DO.2032.28	DO.2023.28	DO.2033.28	DO.2024.28	DO.2034.28
LL42.5	DO.2021.29	DO.2031.29	DO.2022.29	DO.2032.29	DO.2023.29	DO.2033.29	DO.2024.29	DO.2034.29
LL43	DO.2021.30	DO.2031.30	DO.2022.30	DO.2032.30	DO.2023.30	DO.2033.30	DO.2024.30	DO.2034.30
LL43.5	DO.2021.31	DO.2031.31	DO.2022.31	DO.2032.31	DO.2023.31	DO.2033.31	DO.2024.31	DO.2034.31

1st Molar pre-welded bands kits

Custom made kits are available on special order
Buy 100 bands custom kit and get bands organizer Free

Zestawy pierścieni na pierwsze trzonowce z akcesoriami

Zestawy dostępne również na indywidualne zamówienie
Przy zakupie 100 pierścieni otrzymasz organizer gratis.

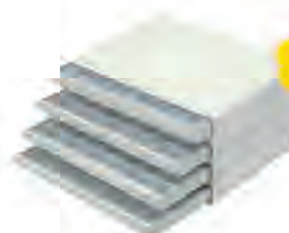

Free
Gratis

Weldable buccal tubes Rurki policzkowe do zgrzewania

Buccal tube single non-convertible 1st molar
Rurka policzkowa pojedyncza niezamienna na pierwszy trzonowiec



Maxillary / Szczęka						
Torque/Tork	Offset/Offset dziąsłowy	Slot/Slot	Rx	Headgear slot/Tuba do wyciągu zew	Upper left / Góra lewa	Upper right / Góra prawa
-14°	10°	0.22"	Roth	x	DO.2230.20	DO.2230.21
Mandibular / Żuchwa						
Torque/Tork	Offset/Offset dziąsłowy	Slot/Slot	Rx	Headgear slot/Tuba do wyciągu zew	Lower left / Dół lewa	Lower right / Dół prawa
-30°	4°	0.22"	Roth	x	DO.2240.20	DO.2240.21

Buccal tube single convertible 1st molar
Rurka policzkowa pojedyncza zamienna na pierwszy trzonowiec



Maxillary / Szczęka						
Torque/Tork	Offset/Offset dziąsłowy	Slot/Slot	Rx	Headgear slot/Tuba do wyciągu zew	Upper left / Góra lewa	Upper right / Góra prawa
-14°	10°	0.22"	Roth	x	DO.2200.20	DO.2200.21
Mandibular / Żuchwa						
Torque/Tork	Offset/Offset dziąsłowy	Slot/Slot	Rx	Headgear slot/Tuba do wyciągu zew	Lower left / Dół lewa	Lower right / Dół prawa
-30°	4°	0.22"	Roth	x	DO.2220.20	DO.2220.21

Buccal tube double convertible, occlusal headgear tube 1st molar
Rurka policzkowa podwójna zamienna z tubą do wyciągu zewnątrzustnego od strony płaszczyzny zgryzowej na pierwszy trzonowiec



Maxillary / Szczęka						
Torque/Tork	Offset/Offset dziąsłowy	Slot/Slot	Rx	Headgear slot/Tuba do wyciągu zew	Upper left / Góra lewa	Upper right / Góra prawa
-14°	10°	0.22"	Roth	.045°	DO.2205.20	DO.2205.21
Mandibular / Żuchwa						
Torque/Tork	Offset/Offset dziąsłowy	Slot/Slot	Rx	Headgear slot/Tuba do wyciągu zew	Lower left / Dół lewa	Lower right / Dół prawa
-30°	4°	0.22"	Roth	.045°	DO.2225.20	DO.2225.21

Buccal tube triple convertible, occlusal headgear tube 1st molar
Rurka policzkowa potrójna zamienna z tubą do wyciągu zewnątrzustnego od strony płaszczyzny zgryzowej na pierwszy trzonowiec



Maxillary / Szczęka						
Torque/Tork	Offset/Offset dziąsłowy	Slot/Slot	Rx	Headgear slot/Tuba do wyciągu zew	Upper left / Góra lewa	Upper right / Góra prawa
-14°	10°	0.22"	Roth	.045°	DO.2210.20	DO.2210.21

Deluxe weldable buccal tubes Deluxe rurki policzkowe do zgrzewania

Buccal tube single convertible 1st molar
Rurka policzkowa pojedyncza zamienna na pierwszy trzonowiec



Made in USA



Maxillary / Szczęka						
Torque/Tork	Offset/Offset dziąsłowy	Slot/Slot	Rx	Headgear slot/Tuba do wyciągu zew	Upper left / Góra lewa	Upper right / Góra prawa
-14°	8°	0.18"	Roth	x	DO.2300.10	DO.2300.11
-14°	8°	0.22"	Roth	x	DO.2300.20	DO.2300.21
Mandibular / Żuchwa						
Torque/Tork	Offset/Offset dziąsłowy	Slot/Slot	Rx	Headgear slot/Tuba do wyciągu zew	Lower left / Dół lewa	Lower right / Dół prawa
-25°	5°	0.18"	Roth	x	DO.2320.10	DO.2320.11
-25°	5°	0.22"	Roth	x	DO.2320.20	DO.2320.21

Buccal tube Double convertible 1st molar
Rurka policzkowa Podwójna zamienna na pierwszy trzonowiec



Maxillary / Szczęka						
Torque/Tork	Offset/Offset dziąsłowy	Slot/Slot	Rx	Headgear slot/Tuba do wyciągu zew	Upper left / Góra lewa	Upper right / Góra prawa
-14°	8°	0.18"	Roth	.018 x .025°	DO.2303.10	DO.2303.11
-14°	8°	0.22"	Roth	.018 x .025°	DO.2303.20	DO.2303.21
Mandibular / Żuchwa						
Torque/Tork	Offset/Offset dziąsłowy	Slot/Slot	Rx	Headgear slot/Tuba do wyciągu zew	Lower left / Dół lewa	Lower right / Dół prawa
-25°	5°	0.18"	Roth	.018 x .025°	DO.2323.10	DO.2323.11
-25°	5°	0.22"	Roth	.018 x .025°	DO.2323.20	DO.2323.21

Deluxe weldable buccal tubes
Deluxe rurki policzkowe do zgrzewania



Buccal tube double convertible, occlusal headgear tube 1st molar

Rurka policzkowa podwójna zamienna na pierwszy trzonowiec z tubą do wyciągu zewnątrzstępnego od strony płaszczyzny zgryzowej

Maxillary / Szczęka

Torque/Tork	Offset/Offset dziąsłowy	Slot/Slot	Rx	Headgear slot/Tuba do wyciągu zew	Upper left / Góra lewa	Upper right / Góra prawa
-14°	8°	0.18"	Roth	.045"	DO.2305.10	DO.2305.11
-14°	8°	0.22"	Roth	.045"	DO.2305.20	DO.2305.21



Buccal tube double convertible, gingival headgear tube 1st molar

Rurka policzkowa podwójna zamienna z tubą do wyciągu zewnątrzstępnego od strony dziąsła

Maxillary / Szczęka

Torque/Tork	Offset/Offset dziąsłowy	Slot/Slot	Rx	Headgear slot/Tuba do wyciągu zew	Upper left / Góra lewa	Upper right / Góra prawa
-14°	8°	0.18"	Roth	.045"	DO.2307.10	DO.2307.11
-14°	8°	0.22"	Roth	.045"	DO.2307.20	DO.2307.21



Buccal tube double convertible, occlusal headgear tube 1st molar

Rurka policzkowa podwójna zamienna z tubą do wyciągu zewnątrzstępnego od strony płaszczyzny zgryzowej

Mandibular / Żuchwa

Torque/Tork	Offset/Offset dziąsłowy	Slot/Slot	Rx	Headgear slot/Tuba do wyciągu zew	Lower left / Dół lewa	Lower right / Dół prawa
-25°	5°	0.18"	Roth	.045"	DO.2325.10	DO.2325.11
-25°	5°	0.22"	Roth	.045"	DO.2325.20	DO.2325.21



Buccal tube triple convertible, occlusal headgear tube 1st molar

Rurka policzkowa potrójna zamienna z tubą do wyciągu zewnątrzstępnego od strony płaszczyzny zgryzowej

Maxillary / Szczęka

Torque/Tork	Offset/Offset dziąsłowy	Slot/Slot	Rx	Headgear slot/Tuba do wyciągu zew	Upper left / Góra lewa	Upper right / Góra prawa
-14°	8°	0.18"	Roth	.045"	DO.2310.10	DO.2310.11
-14°	8°	0.22"	Roth	.045"	DO.2310.20	DO.2310.21



Buccal tube single non-convertible 1st molar

Rurka policzkowa pojedyncza niezamienna na pierwszy trzonowiec

Maxillary / Szczęka

Torque/Tork	Offset/Offset dziąsłowy	Slot/Slot	Rx	Headgear slot/Tuba do wyciągu zew	Upper left / Góra lewa	Upper right / Góra prawa
-0°	0°	0.18"	Roth	x	DO.2330.10	DO.2330.11
-0°	8°	0.18"	Roth	x	DO.2330.12	DO.2330.13
-10°	8°	0.18"	Roth	x	DO.2330.14	DO.2330.15
-0°	0°	0.22"	Roth	x	DO.2330.20	DO.2330.21
-0°	8°	0.22"	Roth	x	DO.2330.22	DO.2330.23
-10°	8°	0.22"	Roth	x	DO.2330.24	DO.2330.25



Buccal tube single non-convertible 1st molar

Rurka policzkowa pojedyncza niezamienna na pierwszy trzonowiec

Mandibular / Żuchwa

Torque/Tork	Offset/Offset dziąsłowy	Slot/Slot	Rx	Headgear slot/Tuba do wyciągu zew	Lower left / Dół lewa	Lower right / Dół prawa
-0°	0°	0.18"	Roth	x	DO.2340.10	DO.2340.11
-0°	5°	0.18"	Roth	x	DO.2340.12	DO.2340.13
-25°	5°	0.18"	Roth	x	DO.2340.14	DO.2340.15
-0°	0°	0.22"	Roth	x	DO.2340.20	DO.2340.21
-0°	5°	0.22"	Roth	x	DO.2340.22	DO.2340.23
-25°	5°	0.22"	Roth	x	DO.2340.24	DO.2340.25



Buccal Double non-convertible, occlusal headgear tube 1st molar

Rurka policzkowa podwójna niezamienna z tubą do wyciągu zewnątrzstępnego od strony płaszczyzny zgryzowej

Maxillary / Szczęka

Torque/Tork	Offset/Offset dziąsłowy	Slot/Slot	Rx	Headgear slot/Tuba do wyciągu zew	Upper left / Góra lewa	Upper right / Góra prawa
-0°	0°	0.18"	Roth	x	DO.2333.10	DO.2333.11
-0°	8°	0.18"	Roth	x	DO.2333.12	DO.2333.13
-10°	8°	0.18"	Roth	x	DO.2333.14	DO.2333.15
-0°	0°	0.22"	Roth	x	DO.2333.20	DO.2333.21
-0°	8°	0.22"	Roth	x	DO.2333.22	DO.2333.23
-10°	8°	0.22"	Roth	x	DO.2333.24	DO.2333.25

Bondable buccal tubes
Rurki policzkowe do przyklejania

Buccal tube single non-convertible with long hook 1st molar
 Rurka policzkowa pojedyncza niezamienna z haczykiem na pierwszy trzonowiec

Maxillary / Szczęka

Torque/Tork	Offset/Offset dziąsłowy	Slot/Slot	Rx	Headgear slot/Tuba do wyciągu zew	Upper left / Góra lewa	Upper right / Góra prawa
-14°	10°	0.22"	Roth / MBT	x	DO.2285.20	DO.2285.21



Buccal tube single non-convertible 1st molar
 Rurka policzkowa pojedyncza niezamienna na pierwszy trzonowiec

Maxillary / Szczęka

Torque/Tork	Offset/Offset dziąsłowy	Slot/Slot	Rx	Headgear slot/Tuba do wyciągu zew	Upper left / Góra lewa	Upper right / Góra prawa
-14°	10°	0.22"	Roth	x	DO.2280.20	DO.2280.21
-14°	10°	0.22"	MBT	x	DO.2282.20	DO.2282.21



Mandibular / Żuchwa

Torque/Tork	Offset/Offset dziąsłowy	Slot/Slot	Rx	Headgear slot/Tuba do wyciągu zew	Lower left / Dół lewa	Lower right / Dół prawa
-30°	4°	0.22"	Roth	x	DO.2290.20	DO.2290.21
-30°	4°	0.22"	MBT	x	DO.2292.20	DO.2292.21



Buccal tube single non-convertible 2nd molar
 Rurka policzkowa pojedyncza niezamienna na drugi trzonowiec

Maxillary / Szczęka

Torque/Tork	Offset/Offset dziąsłowy	Slot/Slot	Rx	Headgear slot/Tuba do wyciągu zew	Upper left / Góra lewa	Upper right / Góra prawa
-14°	10°	0.22"	Roth	x	DO.2281.20	DO.2281.21
-14°	10°	0.22"	MBT	x	DO.2283.20	DO.2283.21



Mandibular / Żuchwa

Torque/Tork	Offset/Offset dziąsłowy	Slot/Slot	Rx	Headgear slot/Tuba do wyciągu zew	Lower left / Dół lewa	Lower right / Dół prawa
-30°	4°	0.22"	Roth	x	DO.2291.20	DO.2291.21
-30°	4°	0.22"	MBT	x	DO.2293.20	DO.2293.21



Buccal tube single convertible 1st molar
 Rurka policzkowa pojedyncza zamienna na pierwszy trzonowiec

Maxillary / Szczęka

Torque/Tork	Offset/Offset dziąsłowy	Slot/Slot	Rx	Headgear slot/Tuba do wyciągu zew	Upper left / Góra lewa	Upper right / Góra prawa
-14°	10°	0.18"	Roth	x	x	x
-14°	10°	0.22"	Roth	x	DO.2250.20	DO.2250.21
-14°	10°	0.18"	MBT	x	x	x
-14°	10°	0.22"	MBT	x	DO.2251.20	DO.2251.21



Mandibular / Żuchwa

Torque/Tork	Offset/Offset dziąsłowy	Slot/Slot	Rx	Headgear slot/Tuba do wyciągu zew	Lower left / Dół lewa	Lower right / Dół prawa
-30°	4°	0.18"	Roth	x	x	x
-30°	4°	0.22"	Roth	x	DO.2270.20	DO.2270.21
-30°	4°	0.18"	MBT	x	x	x
-30°	4°	0.22"	MBT	x	DO.2271.20	DO.2271.21



Buccal tube double convertible, occlusal headgear tube 1st molar
 Rurka policzkowa podwójna zamienna z tubą do wyciągu zewnątrzustnego od strony płaszczyzny zgryzowej na pierwszy trzonowiec

Maxillary / Szczęka

Torque/Tork	Offset/Offset dziąsłowy	Slot/Slot	Rx	Headgear slot/Tuba do wyciągu zew	Upper left / Góra lewa	Upper right / Góra prawa
-14°	10°	0.18"	Roth	045°	x	x
-14°	10°	0.22"	Roth	045°	DO.2255.20	DO.2255.21
-14°	10°	0.18"	MBT	045°	x	x
-14°	10°	0.22"	MBT	045°	DO.2256.20	DO.2256.21



Buccal tube triple convertible, occlusal headgear tube 1st molar
 Rurka policzkowa potrójna zamienna z tubą do wyciągu zewnątrzustnego od strony płaszczyzny zgryzowej na pierwszy trzonowiec

Maxillary / Szczęka

Torque/Tork	Offset/Offset dziąsłowy	Slot/Slot	Rx	Headgear slot/Tuba do wyciągu zew	Upper left / Góra lewa	Upper right / Góra prawa
-14°	10°	0.22"	Roth	045°	DO.2260.20	DO.2260.21



Buccal tube double rectangle non-convertible 1st molar
 Rurka policzkowa podwójna niezamienna na pierwszy trzonowiec

Maxillary / Szczęka

Torque/Tork	Offset/Offset dziąsłowy	Slot/Slot	Rx	Headgear slot/Tuba do wyciągu zew	Upper left / Góra lewa	Upper right / Góra prawa
-14°	10°	0.22"	Roth	x	DO.2284.20	DO.2284.21



Buccal tube double convertible 1st molar
 Rurka policzkowa podwójna zamienna na pierwszy trzonowiec

Mandibular / Żuchwa

Torque/Tork	Offset/Offset dziąsłowy	Slot/Slot	Rx	Headgear slot/Tuba do wyciągu zew	Lower left / Dół lewa	Lower right / Dół prawa
-30°	4°	0.22"	Roth	x	DO.2273.20	DO.2273.21

Bondable buccal tubes Rurki policzkowe do przyklejania

Buccal tube double convertible, lip bumper tube 1st molar
Rurka policzkowa podwójna zamienna z tubą do peloty wargowej na pierwszy trzonowiec

Torque/Tork	Offset/Offset dziąsłowy	Slot/Slot	Rx	Headgear slot/Tuba do wyciągu zew	Lower left / Dół lewa	Lower right / Dół prawa
-20°	0°	0.22"	Roth	.045"	DO.2275.20	DO.2275.21
-20°	0°	0.22"	MBT	.045"	DO.2276.20	DO.2276.21

Mandibular / Żuchwa



Deluxe bondable buccal tubes Deluxe rurki policzkowe do przyklejania



Made in USA

Buccal tube single convertible 1st molar
Rurka policzkowa pojedyncza zamienna na pierwszy trzonowiec

Torque/Tork	Offset/Offset dziąsłowy	Slot/Slot	Rx	Headgear slot/Tuba do wyciągu zew	Upper left / Góra lewa	Upper right / Góra prawa
-14°	8°	0.18"	Roth	x	DO.2350.10	DO.2350.11
-14°	8°	0.22"	Roth	x	DO.2350.20	DO.2350.21

Maxillary / Szczęka



Torque/Tork	Offset/Offset dziąsłowy	Slot/Slot	Rx	Headgear slot/Tuba do wyciągu zew	Lower left / Dół lewa	Lower right / Dół prawa
-25°	5°	0.18"	Roth	x	DO.2370.10	DO.2370.11
-25°	5°	0.22"	Roth	x	DO.2370.20	DO.2370.21

Mandibular / Żuchwa



Large indented Pad
-26° (6.604mm) x 170° (3.048mm)

Buccal tube Double convertible 1st molar
Rurka policzkowa Podwójna zamienna na pierwszy trzonowiec

Torque/Tork	Offset/Offset dziąsłowy	Slot/Slot	Rx	Headgear slot/Tuba do wyciągu zew	Upper left / Góra lewa	Upper right / Góra prawa
-14°	8°	0.18"	Roth	.018 x .025"	DO.2353.10	DO.2353.11
-14°	8°	0.22"	Roth	.018 x .025"	DO.2353.20	DO.2353.21

Maxillary / Szczęka



Large indented Pad
-26° (6.604mm) x 170° (3.048mm)

Torque/Tork	Offset/Offset dziąsłowy	Slot/Slot	Rx	Headgear slot/Tuba do wyciągu zew	Lower left / Dół lewa	Lower right / Dół prawa
-25°	5°	0.18"	Roth	.018 x .025"	DO.2373.10	DO.2373.11
-25°	5°	0.22"	Roth	.018 x .025"	DO.2373.20	DO.2373.21

Mandibular / Żuchwa



Large indented Pad
-26° (6.604mm) x 170° (3.048mm)

Buccal tube double convertible, occlusal headgear tube 1st molar
Rurka policzkowa podwójna zamienna na pierwszy trzonowiec z tubą do wyciągu zewnątrznośnego od strony płaszczyzny zgryzowej

Torque/Tork	Offset/Offset dziąsłowy	Slot/Slot	Rx	Headgear slot/Tuba do wyciągu zew	Upper left / Góra lewa	Upper right / Góra prawa
-14°	8°	0.18"	Roth	.045"	DO.2355.10	DO.2355.11
-14°	8°	0.22"	Roth	.045"	DO.2355.20	DO.2355.21

Maxillary / Szczęka

Large indented Pad
-26° (6.604mm) x 170° (3.048mm)

Buccal tube double convertible, gingival headgear tube 1st molar
Rurka policzkowa podwójna zamienna z tubą do wyciągu zewnątrznośnego od strony dziąsła

Torque/Tork	Offset/Offset dziąsłowy	Slot/Slot	Rx	Headgear slot/Tuba do wyciągu zew	Upper left / Góra lewa	Upper right / Góra prawa
-14°	8°	0.18"	Roth	.045"	DO.2357.10	DO.2357.11
-14°	8°	0.22"	Roth	.045"	DO.2357.20	DO.2357.21

Maxillary / Szczęka



Buccal tube double convertible, occlusal headgear tube 1st molar
Rurka policzkowa podwójna zamienna z tubą do wyciągu zewnątrznośnego od strony płaszczyzny zgryzowej

Torque/Tork	Offset/Offset dziąsłowy	Slot/Slot	Rx	Headgear slot/Tuba do wyciągu zew	Lower left / Dół lewa	Lower right / Dół prawa
-25°	5°	0.18"	Roth	.045"	DO.2375.10	DO.2375.11
-25°	5°	0.22"	Roth	.045"	DO.2375.20	DO.2375.21

Mandibular / Żuchwa

Large indented Pad
-26° (6.604mm) x 170° (3.048mm)

Buccal tube triple convertible, occlusal headgear tube 1st molar
Rurka policzkowa potrójna zamienna z tubą do wyciągu zewnątrznośnego od strony płaszczyzny zgryzowej

Torque/Tork	Offset/Offset dziąsłowy	Slot/Slot	Rx	Headgear slot/Tuba do wyciągu zew	Upper left / Góra lewa	Upper right / Góra prawa
-14°	8°	0.18"	Roth	.045"	DO.2360.10	DO.2360.11
-14°	8°	0.22"	Roth	.045"	DO.2360.20	DO.2360.21

Maxillary / Szczęka



Large indented Pad
-26° (6.604mm) x 170° (3.048mm)

Deluxe bondable buccal tubes

Deluxe rurki policzkowe do przyklejania



Made in USA

Buccal tube single non-convertible 1st molar
 Rurka policzkowa pojedyncza niezamienna na pierwszy trzonowiec



4.35 x 3.04mm

Torque/Tork	Offset/Offset dziąsłowy	Slot/Slot	Rx	Headgear slot/Tuba do wyciągu zew	Maxillary / Szczeka	
					Upper left / Góra lewa	Upper right / Góra prawa
0°	0°	0.18"	Roth	x	DO.2380.10	DO.2380.11
0°	0°	0.22"	Roth	x	x	DO.2380.21
Mandibular / Żuchwa						
Torque/Tork	Offset/Offset dziąsłowy	Slot/Slot	Rx	Headgear slot/Tuba do wyciągu zew	Lower left / Dół lewa	Lower right / Dół prawa
0°	0°	0.18"	Roth	x	DO.2380.11	DO.2380.10
0°	0°	0.22"	Roth	x	DO.2380.21	x

Buccal tube single non-convertible 1st molar
 Rurka policzkowa pojedyncza niezamienna na pierwszy trzonowiec



4.35 x 3.04mm

Torque/Tork	Offset/Offset dziąsłowy	Slot/Slot	Rx	Headgear slot/Tuba do wyciągu zew	Maxillary / Szczeka	
					Upper left / Góra lewa	Upper right / Góra prawa
0°	8°	0.18"	Roth	x	DO.2380.12	DO.2380.13
-10°	8°	0.18"	Roth	x	DO.2380.14	DO.2380.15
0°	8°	0.22"	Roth	x	DO.2380.22	DO.2380.23
-10°	8°	0.22"	Roth	x	DO.2380.24	DO.2380.25
Mandibular / Żuchwa						
Torque/Tork	Offset/Offset dziąsłowy	Slot/Slot	Rx	Headgear slot/Tuba do wyciągu zew	Lower left / Dół lewa	Lower right / Dół prawa
0°	5°	0.18"	Roth	x	DO.2390.12	DO.2390.13
-25°	5°	0.18"	Roth	x	DO.2390.14	DO.2390.15
0°	5°	0.22"	Roth	x	DO.2390.22	DO.2390.23
-25°	5°	0.22"	Roth	x	DO.2390.24	DO.2390.25

Buccal tube single non-convertible 1st molar
 Rurka policzkowa pojedyncza niezamienna na pierwszy trzonowiec



Large Indented Pad
 .260" (6.604mm) x .120" (3.048mm)

Torque/Tork	Offset/Offset dziąsłowy	Slot/Slot	Rx	Headgear slot/Tuba do wyciągu zew	Maxillary / Szczeka	
					Upper left / Góra lewa	Upper right / Góra prawa
-10°	8°	0.18"	Roth	x	DO.2380.14	DO.2380.15
-10°	8°	0.22"	Roth	x	DO.2380.24	DO.2380.25
Mandibular / Żuchwa						
Torque/Tork	Offset/Offset dziąsłowy	Slot/Slot	Rx	Headgear slot/Tuba do wyciągu zew	Lower left / Dół lewa	Lower right / Dół prawa
-25°	5°	0.18"	Roth	x	DO.2390.14	DO.2390.15
-25°	5°	0.22"	Roth	x	DO.2390.24	DO.2390.25

Buccal double non-convertible, occlusal headgear tube 1st molar
 Rurka policzkowa podwójna niezamienna z tubą do wyciągu zewnętrznego od strony płaszczyzny zgryzowej



Large Indented Pad
 .260" (6.604mm) x .120" (3.048mm)

Torque/Tork	Offset/Offset dziąsłowy	Slot/Slot	Rx	Headgear slot/Tuba do wyciągu zew	Maxillary / Szczeka	
					Upper left / Góra lewa	Upper right / Góra prawa
0°	0°	0.18"	Roth	x	DO.2383.10	DO.2383.11
-10°	8°	0.18"	Roth	x	DO.2383.14	DO.2383.15
0°	0°	0.22"	Roth	x	DO.2383.20	DO.2383.21
-10°	8°	0.22"	Roth	x	DO.2383.24	DO.2383.25

Mini buccal tubes bondable

Rurki mini do przyklejania

Specially designed for partially erupted 2nd molars
 Zaprojektowane dla częściowo wyrżniętych drugich trzonowców



Torque/Tork	Offset/Offset dziąsłowy	Rx	Slot/Slot		
			0.18"	0.22"	
0°	0°	Roth	UL / LR	DO.2381.10	DO.2381.20
0°	0°	Roth	UR / LL	DO.2381.11	DO.2381.21
-10°	0°	Roth	UR	DO.2381.12	DO.2381.22
-10°	0°	Roth	UL	DO.2381.13	DO.2381.23
Mandibular / Żuchwa					
Torque/Tork	Offset/Offset dziąsłowy	Rx	Slot/Slot		
			0.18"	0.22"	
0°	0°	Roth	UR / LL	DO.2381.11	DO.2381.21
-25°	0°	Roth	UL / LR	DO.2381.10	DO.2381.20
0°	0°	Roth	LR	DO.2381.13	DO.2381.23
-25°	0°	Roth	LL	DO.2381.12	DO.2381.22



Sure-Fit

1st and 2nd premolar / bicuspid bands plain / Pierścienie gładkie na przedtrzonowce

Anatomically shaped / Anatomiczny kształt pierścienia
Fast, placement and accurate fit
Umożliwia szybkie umiejscowienie i dokładne jego dopasowanie

Rounded edges / Zawinięte brzegi
No sharp edges for patient comfort
Gładko wykończone krawędzie zapewniają maksymalny komfort pacjenta



Micro-Etched interior surface / Mikrowytrawiona wewnętrzna powierzchnia
For increased bond strength
Zapewnia maksymalne utrzymanie

Ideally hardened stainless steel, for easy contouring
Doskonale zahartowanie materiału, z którego wykonane są pierścienie ułatwia dopasowanie obwodu pierścienia do zęba

Permanent laser marking / Trwale laserowa oznakowanie
For easy identification
Zapewnia łatwą identyfikację



No.	Size Rozmiar	Upper left, right Góra lewa, prawa
1	22.7	DO.2103.01
2	23.1	DO.2103.02
3	23.4	DO.2103.03
4	23.7	DO.2103.04
5	24.3	DO.2103.05
6	24.7	DO.2103.06
7	24.9	DO.2103.07
8	25.4	DO.2103.08
9	25.7	DO.2103.09
10	26.2	DO.2103.10
11	26.5	DO.2103.11
12	26.9	DO.2103.12
13	27.2	DO.2103.13
14	27.6	DO.2103.14
15	27.9	DO.2103.15
16	28.2	DO.2103.16
17	28.8	DO.2103.17
18	29.4	DO.2103.18
19	29.7	DO.2103.19
20	30.0	DO.2103.20
21	30.4	DO.2103.21
22	30.8	DO.2103.22
23	31.1	DO.2103.23
24	31.5	DO.2103.24
25	31.8	DO.2103.25
26	32.1	DO.2103.26
27	32.4	DO.2103.27
28	32.8	DO.2103.28

Upper 1st and 2nd premolars / bicuspid
Do zębów przedtrzonowych górnych pierwszych i drugich



No.	Size Rozmiar	Lower left, right Dół lewy, prawy
3	21.2	DO.2123.03
4	21.4	DO.2123.04
5	21.8	DO.2123.05
6	22.4	DO.2123.06
7	23.0	DO.2123.07
8	23.3	DO.2123.08
9	23.7	DO.2123.09
10	24.2	DO.2123.10
11	24.6	DO.2123.11
12	25.4	DO.2123.12
13	25.8	DO.2123.13
14	26.1	DO.2123.14
15	26.4	DO.2123.15
16	26.8	DO.2123.16
17	27.3	DO.2123.17
18	27.8	DO.2123.18
19	28.2	DO.2123.19
20	28.7	DO.2123.20
21	29.1	DO.2123.21
22	29.5	DO.2123.22
23	30.1	DO.2123.23
24	30.5	DO.2123.24
25	30.8	DO.2123.25
26	31.2	DO.2123.26

Lower 1st and 2nd premolars / bicuspid
Do zębów przedtrzonowych dolnych pierwszych i drugich

Sure-Fit

1st and 2nd premolar / bicuspid bands with weldable brackets / Pierścienie z zamkiem na przedtrzonowce

each / sztuka

Anatomically shaped / Anatomiczny kształt pierścienia
Fast, placement and accurate fit
Umożliwia szybkie umiejscowienie i dokładne jego dopasowanie



Micro-Etched interior surface / Mikrowytłowana wewnętrzna powierzchnia
For increased bond strength
Zapewnia maksymalne utrzymanie

Rounded edges / Zawinięte brzegi
No sharp edges for patient comfort
Gładko wykończone krawędzie zapewniają maksymalny komfort pacjenta

Ideally hardened stainless steel, for easy contouring
Doskonale zahartowanie materiału, z którego wykonane są pierścienie ułatwia dopasowanie obwodu pierścienia do zęba

Permanent laser marking / Trwale laserowe oznakowanie
For easy identification
Zapewnia łatwą identyfikację

With weldable bracket
without hook „Roth 022”
z zamkiem bez haczyk Roth „022”



each / sztuka

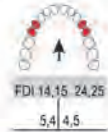

FDI 14,15 24,25
5,4 4,5

With weldable bracket
without hook „Roth 022”
z zamkiem bez haczyk Roth „022”



each / sztuka



FDI 34, 35 44, 45
5,4 4,5

No.	Size Rozmiar	Upper left Góra lewa	Upper right Góra prawa
1	22.7	DO.2104.01	DO.2105.01
2	23.1	DO.2104.02	DO.2105.02
3	23.4	DO.2104.03	DO.2105.03
4	23.7	DO.2104.04	DO.2105.04
5	24.3	DO.2103.05	DO.2105.05
6	24.7	DO.2104.06	DO.2105.06
7	24.9	DO.2104.07	DO.2105.07
8	25.4	DO.2104.08	DO.2105.08
9	25.7	DO.2104.09	DO.2105.09
10	26.2	DO.2104.10	DO.2105.10
11	26.5	DO.2104.11	DO.2105.11
12	26.9	DO.2104.12	DO.2105.12
13	27.2	DO.2104.13	DO.2105.13
14	27.6	DO.2104.14	DO.2105.14
15	27.9	DO.2104.15	DO.2105.15
16	28.2	DO.2104.16	DO.2105.16
17	28.8	DO.2104.17	DO.2105.17
18	29.4	DO.2104.18	DO.2105.18
19	29.7	DO.2104.19	DO.2105.19
20	30.0	DO.2104.20	DO.2105.20
21	30.4	DO.2104.21	DO.2105.21
22	30.8	DO.2104.22	DO.2105.22
23	31.1	DO.2104.23	DO.2105.23
24	31.5	DO.2104.24	DO.2105.24
25	31.8	DO.2104.25	DO.2105.25
26	32.1	DO.2104.26	DO.2105.26
27	32.4	DO.2104.27	DO.2105.27
28	32.8	DO.2104.28	DO.2105.28

No.	Size Rozmiar	Lower left Dół lewy	Lower right Dół prawy
3	21.2	DO.2124.03	DO.2125.03
4	21.4	DO.2124.04	DO.2125.04
5	21.8	DO.2124.05	DO.2125.05
6	22.4	DO.2124.06	DO.2125.06
7	23.0	DO.2124.07	DO.2125.07
8	23.3	DO.2124.08	DO.2125.08
9	23.7	DO.2124.09	DO.2125.09
10	24.2	DO.2120.10	DO.2125.10
11	24.6	DO.2124.11	DO.2125.11
12	25.4	DO.2124.12	DO.2125.12
13	25.8	DO.2124.13	DO.2125.13
14	26.1	DO.2124.14	DO.2125.14
15	26.4	DO.2124.15	DO.2125.15
16	26.8	DO.2124.16	DO.2125.16
17	27.3	DO.2124.17	DO.2125.17
18	27.8	DO.2124.18	DO.2125.18
19	28.2	DO.2124.19	DO.2125.19
20	28.7	DO.2124.20	DO.2125.20
21	29.1	DO.2124.21	DO.2125.21
22	29.5	DO.2124.22	DO.2125.22
23	30.1	DO.2124.23	DO.2125.23
24	30.5	DO.2124.24	DO.2125.24
25	30.8	DO.2124.25	DO.2125.25
26	31.2	DO.2124.26	DO.2125.26

Lower 1st and 2nd premolars / bicuspid
Do zębów przedtrzonowych dolnych pierwszych i drugich

Upper 1st and 2nd premolars / bicuspid
Do zębów przedtrzonowych górnych pierwszych i drugich

Brackets weldable for premolar bands
Zamki do zgrzewania z pierścieniami na przedtrzonowce



Pack of 10 pieces
Opak. 10 szt.

Lingual cleat weldable for premolar bands
Klit językowy do zgrzewania z pierścieniami na trzonowce



Pack of 10 pieces
Opak. 10 szt.

Roth .022"	1st premolar Pierwsze przedtrzonowce	2nd premolar Drugie przedtrzonowce
Upper right / Góra prawa	DO.2410.01	DO.2410.03
Upper left / Góra lewa	DO.2410.02	DO.2410.04
Lower right / Dół prawy	DO.2411.01	DO.2411.03
Lower left / Dół 4 lewy	DO.2411.02	DO.2411.04

DO.2441.20

Weldable accessories / Akcesoria do zgrzewania

Lingual cleats / Klity językowe

Pack of 10 pieces
Opak. 10 szt.



DO.2441.01



DO.2441.02

Lingual buttons / Guziczki językowe

Pack of 10 pieces
Opak. 10 szt.



DO.2424.01
Round / Okragłe



DO.2423.02
Oval / Owalne

Bite turbos / Płaszczyzny nagryzowe bite turbos



DO.2520.03
Pack of 10 pieces
Opak. 10 szt.

Lingual sheaths / Rurki językowe

Pack of 10 pieces
Opak. 10 szt.



DO.2430.01



DO.2432.01
Upper left / Lower right
Góra lewa/ Dół prawy



DO.2432.02
Upper right / Lower left
Góra prawa / Dół lewy

Bondable accessories / Akcesoria do przyklejania

Lingual buttons / Guziczki językowe

Pack of 10 pieces
Opak. 10 szt.



DO.2420.01
Round / Okragłe



DO.2420.02
Round perforated base
Podstawa perforowana



DO.2420.03
Round / Okragłe



DO.2421.01
Oval / Owalne
Curved base



DO.2421.02
Oval / Owalne



DO.2421.03
Oval / Owalne
Flat base



DO.2420.04
Round / Okragłe



DO.2428.01



DO.2429.01
Upper left / Lower right
Góra lewa/ Dół prawy



DO.2429.02
Upper right / Lower left
Góra prawa / Dół lewy

Lingual buttons composite
Guziczki językowe kompozytowe

Pack of 4 pieces
Opak. 4 szt.



DO.2425.01

Lingual buttons ceramic
Guziczki językowe ceramiczne

Pack of 4 pieces
Opak. 4 szt.



DO.2425.02

Lingual cleats
Klity językowe

Pack of 10 pieces
Opak. 10 szt.



DO.2442.01

Lingual pulling rings
Guziczki językowe do ekstruzji z oczkiem

Pack of 10 pieces
Opak. 10 szt.



DO.2450.03
Round / Okragłe

Eyelet
Zaczep oczkowy

Pack of 10 pieces
Opak. 10 szt.



DO.2450.01

Pack of 10 pieces
Opak. 10 szt.

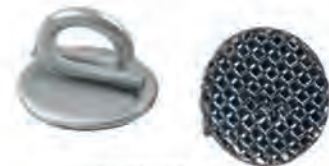

DO.2450.02

Aesthetic eyelet
Zaczep oczkowy

Pack of 10 piece
Opak. 10 szt.



DO.2450.05
Ceramic / Ceramiczne

Pack of 10 pieces
Opak. 10 szt.



DO.2450.04
Composite / kompozytowe

Bicuspid bondable tube with hook



Maxillary / Szczęka					
Torque/Tork	Offset/Offset dziąsłowy	Slot/Slot	Rx	Upper left / Góra lewa	Upper right / Góra prawa
-7°	0°	0.22"	Roth	DO.2460.02	DO.2460.01
Mandibular / Żuchwa					
Torque/Tork	Offset/Offset dziąsłowy	Slot/Slot	Rx	Lower left / Dół lewa	Lower right / Dół prawa
-20°	0°	0.22"	Roth	DO.2461.02	DO.2461.01

Eruption appliance
Akcesoria do wprowadzania zatrzymanych zębów do łuku

each / sztuka



DO.2455.01
Round eyelet with chain silver
Guziczek z łańcuszkiem srebrny, okrągła podstawa



DO.2455.02
Round eyelet with chain gold plated
Guziczek z łańcuszkiem złoty, okrągła podstawa

each / sztuka



DO.2455.11
Rectangular eyelet with chain silver
Guziczek z łańcuszkiem srebrny, prostokątna podstawa



DO.2455.12
Rectangular eyelet with chain gold plated
Guziczek z łańcuszkiem złoty, prostokątna podstawa

MaxiFlex™

Super elastic nickel titanium archwires / Łuki Niklowo-Tytanowe

Superelastic 1 (SE1) wire rounds out austenitic Nickel Titanium wire line. The moderate, consistent forces exhibited by SE1 wire provide a great avenue for early to mid-stage treatment. It provides slightly less force than our Black-Ti wire, and is fully austenitic at room temperature. Due to its high flexibility and resiliency, Superelastic 1 wire recovers beautifully from bends and deformation of angles up to 45°, and even up to 75° in some cases!

- Moderate, consistent force
- Greater patient comfort than over a long activation period, with Stainless Steel wires.
- Excellent resiliency.
- Highly flexible.
- Responsive to chilling.
- Af of 45-60° F (7.2-15.6°C).
- Square and Rectangle wires offer ability to simultaneously level and add torque and rotation earlier in treatment. More efficient than treatment with Stainless Steel.

Pack of 10 pieces / Opak. 10 szt.



Made in USA

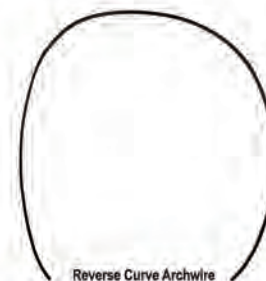
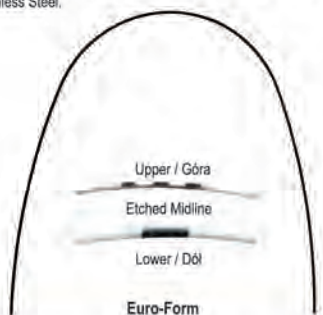

Round / okrągłe	Upper / Góra	Lower / Dół	Upper / Góra	Lower / Dół	Upper / Góra	Lower / Dół
○						
.012"	DO.3100.12	DO.3101.12	DO.3110.12	DO.3111.12	DO.3300.12	DO.3301.12
.014"	DO.3100.14	DO.3101.14	DO.3110.14	DO.3111.14	DO.3300.14	DO.3301.14
.016"	DO.3100.16	DO.3101.16	DO.3110.16	DO.3111.16	DO.3300.16	DO.3301.16
.018"	DO.3100.18	DO.3101.18	DO.3110.18	DO.3111.18	DO.3300.18	DO.3301.18
.020"	DO.3100.20	DO.3101.20	DO.3110.20	DO.3111.20	DO.3300.20	DO.3301.20
Square / kwadratowe	Upper / Góra	Lower / Dół	Upper / Góra	Lower / Dół	Upper / Góra	Lower / Dół
□						
.016" x .016"	DO.3102.16	DO.3103.16	DO.3112.16	DO.3113.16	DO.3302.16	DO.3303.16
.018" x .018"	DO.3102.18	DO.3103.18	DO.3112.18	DO.3113.18	DO.3302.18	DO.3303.18
Rectangle / prostokątne	Upper / Góra	Lower / Dół	Upper / Góra	Lower / Dół	Upper / Góra	Lower / Dół
▭						
.016" x .022"	DO.3104.62	DO.3107.62	DO.3114.62	DO.3117.62	DO.3304.62	DO.3307.62
.017" x .025"	DO.3104.75	DO.3107.75	DO.3114.75	DO.3117.75	DO.3304.75	DO.3307.75
.018" x .025"	DO.3104.85	DO.3107.85	DO.3114.85	DO.3117.85	DO.3304.85	DO.3307.85
.019" x .025"	DO.3104.95	DO.3107.95	DO.3114.95	DO.3117.95	DO.3304.95	DO.3307.95
.021" x .025"	DO.3105.15	DO.3108.15	DO.3115.15	DO.3118.15	DO.3305.15	DO.3308.15

Dentolline®

orthodontic products

Super elastic nickel titanium archwires / Łuki Niklowo-Tytanowe

High quality wires

Individually packed in sterilization pouch to protect against cross infection, non-sterile.

Wysokiej jakości łuki

Pakowane osobno w torebki sterylizacyjne, aby uniknąć zakażeń, niesterylne.

Pack of 10 pieces / Opak. 10 szt.

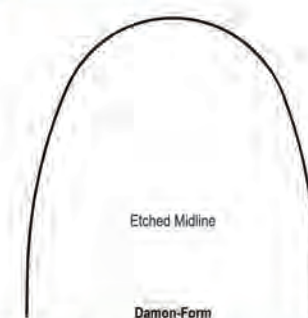
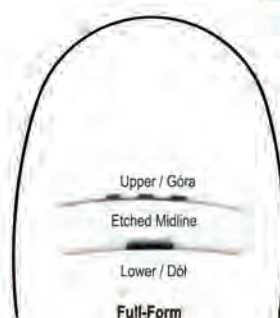

Round / okrągłe	Upper / Góra	Lower / Dół	Upper / Góra	Lower / Dół	Round / okrągłe	Universal / Uniwersalne
○					○	
.010"	DL300000-E	DL300037-E	DL300000	DL300037	.010"	DL300200
.012"	DL300001-E	DL300007-E	DL300001	DL300007	.012"	DL300201
.013"	DL300002-E	DL300008-E	DL300002	DL300008	.013"	DL300202
.014"	DL300003-E	DL300009-E	DL300003	DL300009	.014"	DL300203
.016"	DL300004-E	DL300010-E	DL300004	DL300010	.016"	DL300204
.018"	DL300005-E	DL300011-E	DL300005	DL300011	.018"	DL300205
.020"	DL300006-E	DL300012-E	DL300006	DL300012	.020"	DL300206



Super elastic nickel titanium archwires / Łuki Niklowo-Tytanowe

High quality wires

Individually packed in sterilization pouch to protect against cross infection, non-sterile.

Wysokiej jakości łuki

Pakowane osobno w torebki sterylizacyjne, aby uniknąć zakażeń, niesterylne.

Pack of 10 pieces / Opak. 10 szt.

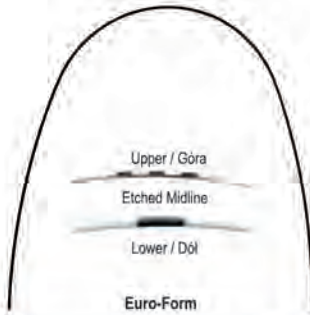

Euro-Form

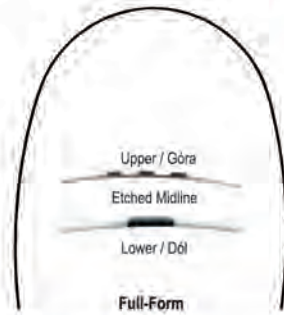

Full-Form



Damon-Form

Rectangle / prostokątne

	Upper / Góra	Lower / Dół	Upper / Góra	Lower / Dół
.014" x .025"	DL300013-E	DL300025-E	DL300013	DL300025
.016" x .022"	DL300015-E	DL300027-E	DL300015	DL300027
.016" x .025"	DL300016-E	DL300028-E	DL300016	DL300028
.017" x .022"	DL300017-E	DL300029-E	DL300017	DL300029
.017" x .025"	DL300018-E	DL300030-E	DL300018	DL300030
.018" x .022"	DL300020-E	DL300032-E	DL300020	DL300032
.018" x .025"	DL300021-E	DL300033-E	DL300021	DL300033
.019" x .025"	DL300022-E	DL300034-E	DL300022	DL300034
.021" x .025"	DL300024-E	DL300036-E	DL300024	DL300036

Rectangle / prostokątne

	Universal / Uniwersalne
.014" x .025"	DL300213
.016" x .022"	DL300215
.016" x .025"	DL300216
.017" x .022"	DL300217
.017" x .025"	DL300218
.018" x .022"	DL300220
.018" x .025"	DL300221
.019" x .025"	DL300222
.021" x .025"	DL300224

Square / kwadratowe

	Upper / Góra	Lower / Dół	Upper / Góra	Lower / Dół
.016" x .016"	DL300014-E	DL300026-E	DL300014	DL300026
.018" x .018"	DL300019-E	DL300031-E	DL300019	DL300031
.020" x .020"	DL300023-E	DL300035-E	DL300023	DL300035

Square / kwadratowe

	Universal / Uniwersalne
.016" x .016"	DL300214
.018" x .018"	DL300219
.020" x .020"	DL300223

Pack of 10 pieces / Opak. 10 szt.

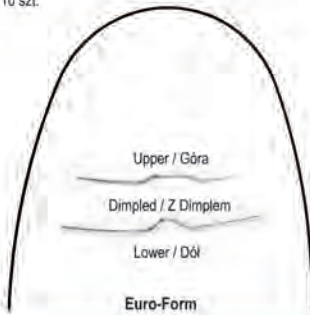

Euro-Form

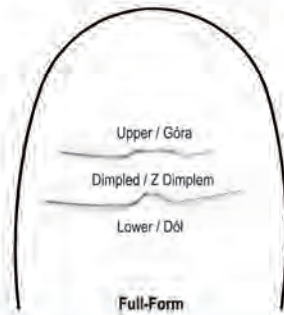

Full-Form

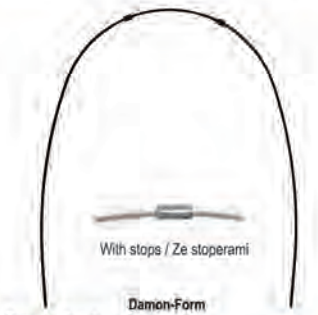

Damon-Form

Round / okrągłe

	Upper / Góra	Lower / Dół	Upper / Góra	Lower / Dół
.010"	DL300038-E	DL300039-E	DL300038	DL300039
.012"	DL300040-E	DL300046-E	DL300040	DL300046
.013"	DL300041-E	DL300047-E	DL300041	DL300047
.014"	DL300042-E	DL300048-E	DL300042	DL300048
.016"	DL300043-E	DL300049-E	DL300043	DL300049
.018"	DL300044-E	DL300050-E	DL300044	DL300050
.020"	DL300045-E	DL300051-E	DL300045	DL300051

Round / okrągłe

	Universal / Uniwersalne
.012"	DL300240
.013"	DL300241
.014"	DL300242
.016"	DL300243
.018"	DL300244
.020"	DL300245

Rectangle / prostokątne

	Upper / Góra	Lower / Dół	Upper / Góra	Lower / Dół
.014" x .025"	DL300052-E	DL300064-E	DL300052	DL300064
.016" x .022"	DL300054-E	DL300066-E	DL300054	DL300066
.016" x .025"	DL300055-E	DL300067-E	DL300055	DL300067
.017" x .022"	DL300056-E	DL300068-E	DL300056	DL300068
.017" x .025"	DL300057-E	DL300069-E	DL300057	DL300069
.018" x .022"	DL300059-E	DL300071-E	DL300059	DL300071
.018" x .025"	DL300060-E	DL300072-E	DL300060	DL300072
.019" x .025"	DL300061-E	DL300073-E	DL300061	DL300073
.021" x .025"	DL300063-E	DL300075-E	DL300063	DL300075

Rectangle / prostokątne

	Universal / Uniwersalne
.014" x .025"	DL300252
.016" x .022"	DL300254
.016" x .025"	DL300255
.017" x .022"	DL300256
.017" x .025"	DL300257
.018" x .022"	DL300259
.018" x .025"	DL300260
.019" x .025"	DL300261
.021" x .025"	DL300263

Square / kwadratowe

	Upper / Góra	Lower / Dół	Upper / Góra	Lower / Dół
.016" x .016"	DL300053-E	DL300065-E	DL300053	DL300065
.018" x .018"	DL300058-E	DL300070-E	DL300058	DL300070
.020" x .020"	DL300062-E	DL300074-E	DL300062	DL300074

Square / kwadratowe

	Universal / Uniwersalne
.016" x .016"	DL300253
.018" x .018"	DL300258
.020" x .020"	DL300262

Invisa-Flex™

Tooth-Tone nickel titanium archwires / Łuki Niklowo-Tytanowe kosmetyczne



The same great features as our TruFlex Nickel Titanium archwires with a durable tooth colored overcoat which offers superior aesthetics, stain resistance, and low friction. Size shown is finished size. Tooth Tone coating adds .002" thickness to diameter

Oporne na przebarwienia łuki powlekane Tooth Tone zapewniają dużą estetykę oraz niskie tarcie. Rozmiar łuku zawiera pokrycie o grubości .002"

Pack of 2 pieces / Opak. 2 szt.



Round / okrągłe	Full-Form		Reverse Curve Archwire	
○	Upper / Góra	Lower / Dół	Upper / Góra	Lower / Dół
.014"	DO.3800.14	DO.3801.14	DO.3880.14	DO.3881.14
.016"	DO.3800.16	DO.3801.16	DO.3880.16	DO.3881.16
.018"	DO.3800.18	DO.3801.18	DO.3880.18	DO.3881.18
.020"	DO.3800.20	DO.3801.20	DO.3880.20	DO.3881.20

Square / kwadratowe	Upper / Góra	Lower / Dół	Upper / Góra	Lower / Dół
.018" x .018"	DO.3802.18	DO.3803.18	DO.3882.18	DO.3883.18
.020" x .020"	DO.3802.20	DO.3803.20		

Rectangle / prostokątne	Upper / Góra	Lower / Dół	Upper / Góra	Lower / Dół
.016" x .022"	DO.3804.62	DO.3807.62		
.018" x .024"	DO.3804.84	DO.3807.84	DO.3884.84	DO.3887.84
.019" x .027"	DO.3804.97	DO.3807.97		
.021" x .027"	DO.3805.17	DO.3808.17		

SANI-PAK

Aesthetic Micro-Coated Archwires
Łuki estetyczne pokryte mikro-warstwą

The perfect combination of aesthetics and functionality. Micro coating is only done on labial surface of archwire to reduce friction and improve sliding mechanics compared to fully coated wire.

True archwire size because coating is only .0005" thick compared to .002" of competitive brands.

The coating is resistant to staining and cracking even if the archwire shape is changed.

All Micro-Coated Archwires are individually packaged & sealed in an autoclavable pack to protect your patients from cross infection.

Doskonałe połączenie estetyki i funkcjonalności. Łuki pokryte mikro-warstwą, mikro tylko od strony wargowej, redukują tarcie oraz zapewniają swobodniejsze umieszczenie łuku niż tradycyjne łuki powlekane.

"Prawdziwy" rozmiar łuku ponieważ pokrycie wynosi .0005" w porównaniu do innych łuków, których pokrycie wynosi .002"

Pokrycie jest odporne na plamy i zadrapania, nawet gdy kształt łuku ulegnie zmianie.

Wszystkie łuki pokryte mikro-warstwą są pakowane osobno, niesterylne.



Invisa-Flex™ Micro Coated

Tooth-Tone micro coated NiTi archwires
Łuki NiTi kosmetyczne pokryte mikro-warstwą

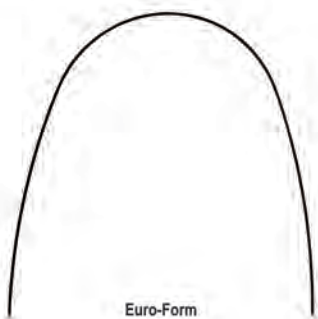

Euro-Form

Round / okrągłe	Each / Sztuka	
○	Upper / Góra	Lower / Dół
.012"	DO.3820.12	DO.3821.12
.014"	DO.3820.14	DO.3821.14
.016"	DO.3820.16	DO.3821.16
.018"	DO.3820.18	DO.3821.18
.020"	DO.3820.20	DO.3821.20

Square / kwadratowe	Upper / Góra	Lower / Dół
.016" x .016"	DO.3822.16	DO.3823.16

Rectangle / prostokątne	Upper / Góra	Lower / Dół
.016" x .022"	DO.3824.62	DO.3827.62
.017" x .025"	DO.3824.75	DO.3827.75
.018" x .025"	DO.3824.85	DO.3827.85
.019" x .025"	DO.3824.95	DO.3827.95
.021" x .025"	DO.3825.15	DO.3828.15

Dentalline[®]
orthodontic products

Pre-Torqued NITI archwires / Łuki NITI torkujące

Pack of 10 pieces
Opak. 10 szt.

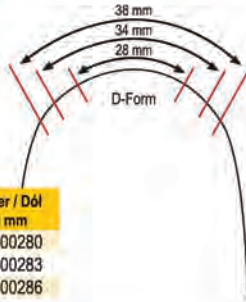

Rectangle Prostokątne	Upper / Góra 34 mm	Upper / Góra 38 mm	Lower / Dół 28 mm
.016 x .025"	DL300281	DL300282	DL300280
.017 x .025"	DL300284	DL300285	DL300283
.019 x .025"	DL300287	DL300288	DL300286

MaxiFlex[™]

Super elastic nickel titanium wires / Drut Niklowo-Tytanowy na szpuli

- Posiada zalety produktów niklowo - tytanowych
- Stała, delikatna siła
- Jest bardzo elastyczny i sprężysty



15" na szpuli (381mm)

○	Round / okrągły
.012"	DO.3486.12
.014"	DO.3486.14
.016"	DO.3486.16
.018"	DO.3486.18
.020"	DO.3486.20

TempFlex[™]

Thermal nickel titanium archwires / Łuki Niklowo-Tytanowe termalne



Pack of 10 pieces / Opak. 10 szt.



Thermal is a heat-activated (thermal) wire specifically designed for consistent Af performance and low tooth-moving forces. Thermal wire provides outstanding resiliency and exhibits true thermal performance. Soft at room temperature and in the doctor's hand, Advanced Thermal allows easy ligation. Outstanding shape integrity.

Specially designed wire for consistent Af performance. Every production lot of Advanced Thermal wires is water bath tested to verify Af of 80-90°F (26.7-32.2°C). Soft at room temperature; very easy to ligate. Great resiliency. Ideal for significant crowding cases. Gentle forces provide for greater patient comfort. Very responsive to chilling. Square and Rectangle wire sizes provide low, consistent toothmoving forces to address torque control early in treatment

Charakteryzuje działanie stałej i zarazem niewielkiej siły. Łuki są giętkie w temperaturze pokojowej oraz posiadają elastyczne właściwości pod wpływem temperatury ciała. Doskonale sprawdzają się w początkowej fazie leczenia. Wyróżnia je gładkie i błyszczące wykończenie.

Dostępne w wersjach full form i euro. Pakowane po 10 sztuk. Działanie toothmoving forces to address torque control early in treatment

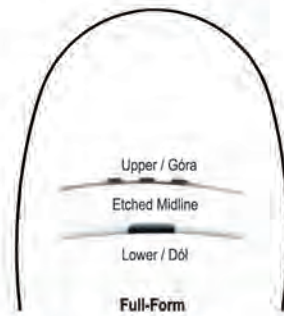

○	Upper / Góra	Lower / Dół	Upper / Góra	Lower / Dół
.014"	DO.3600.14	DO.3601.14	DO.3610.14	DO.3611.14
.016"	DO.3600.16	DO.3601.16	DO.3610.16	DO.3611.16
.018"	DO.3600.18	DO.3601.18	DO.3610.18	DO.3611.18
.020"	DO.3600.20	DO.3601.20	DO.3610.20	DO.3611.20
□	Upper / Góra	Lower / Dół	Upper / Góra	Lower / Dół
.016" x .016"	DO.3602.16	DO.3603.16	DO.3612.16	DO.3613.16
.018" x .018"	DO.3602.18	DO.3603.18	DO.3612.18	DO.3613.18
▢	Upper / Góra	Lower / Dół	Upper / Góra	Lower / Dół
.016" x .022"	DO.3604.62	DO.3607.62	DO.3614.62	DO.3617.62
.017" x .025"	DO.3604.75	DO.3607.75	DO.3614.75	DO.3617.75
.018" x .025"	DO.3604.85	DO.3607.85	DO.3614.85	DO.3617.85
.019" x .025"	DO.3604.95	DO.3607.95	DO.3614.95	DO.3617.95
.021" x .025"	DO.3605.15	DO.3608.15	DO.3615.15	DO.3618.15



High quality wires
Individually packed in sterilization pouch to protect against cross infection, non-sterile.
Wysokiej jakości luki
Pakowane osobno w torebki sterylizacyjne, aby uniknąć zakażeń, niesterylne.

Thermal nickel titanium archwires / Łuki Niklowo-Tytanowe termalne

Pack of 10 pieces / Opak. 10 szt.



Euro-Form		Full-Form		Damon-Form		
Upper / Góra	Lower / Dół	Upper / Góra	Lower / Dół	Universal / Uniwersalne		
Round / okrągłe						
.010"	DL301000-E	DL301037-E	DL301000	DL301037	.010"	DL301200
.012"	DL301001-E	DL301007-E	DL301001	DL301007	.012"	DL301201
.013"	DL301002-E	DL301008-E	DL301002	DL301008	.013"	DL301202
.014"	DL301003-E	DL301009-E	DL301003	DL301009	.014"	DL301203
.016"	DL301004-E	DL301010-E	DL301004	DL301010	.016"	DL301204
.018"	DL301005-E	DL301011-E	DL301005	DL301011	.018"	DL301205
.020"	DL301006-E	DL301012-E	DL301006	DL301012	.020"	DL301206
Rectangle / prostokątne						
.014" x .025"	DL301013-E	DL301025-E	DL301013	DL301025	.014" x .025"	DL301213
.016" x .022"	DL301015-E	DL301027-E	DL301015	DL301027	.016" x .022"	DL301215
.016" x .025"	DL301016-E	DL301028-E	DL301016	DL301028	.016" x .025"	DL301216
.017" x .022"	DL301017-E	DL301029-E	DL301017	DL301029	.017" x .022"	DL301217
.017" x .025"	DL301018-E	DL301030-E	DL301018	DL301030	.017" x .025"	DL301218
.018" x .022"	DL301020-E	DL301032-E	DL301020	DL301032	.018" x .022"	DL301220
.018" x .025"	DL301021-E	DL301033-E	DL301021	DL301033	.018" x .025"	DL301221
.019" x .025"	DL301022-E	DL301034-E	DL301022	DL301034	.019" x .025"	DL301222
.021" x .025"	DL301024-E	DL301036-E	DL301024	DL301036	.021" x .025"	DL301224
Square / kwadratowe						
.016" x .016"	DL301014-E	DL301026-E	DL301014	DL301026	.016" x .016"	DL301214
.018" x .018"	DL301019-E	DL301031-E	DL301019	DL301031	.018" x .018"	DL301219
.020" x .020"	DL301023-E	DL301035-E	DL301023	DL301035	.020" x .020"	DL301223

Pack of 10 pieces / Opak. 10 szt.

Euro-Form		Full-Form		Damon-Form		
Upper / Góra	Lower / Dół	Upper / Góra	Lower / Dół	Universal / Uniwersalne		
Round / okrągłe						
.010"	DL301038-E	DL301039-E	DL301038	DL301039	.012"	DL301240
.012"	DL301040-E	DL301046-E	DL301040	DL301046	.013"	DL301241
.013"	DL301041-E	DL301047-E	DL301041	DL301047	.014"	DL301242
.014"	DL301042-E	DL301048-E	DL301042	DL301048	.016"	DL301243
.016"	DL301043-E	DL301049-E	DL301043	DL301049	.018"	DL301244
.018"	DL301044-E	DL301050-E	DL301044	DL301050	.020"	DL301245
.020"	DL301045-E	DL301051-E	DL301045	DL301051		

Thermal nickel titanium archwires / Łuki Niklowo-Tytanowe termalne

High quality wires

Individually packed in sterilization pouch to protect against cross infection, non-sterile.

Wysokiej jakości łuki

Pakowane osobno w torebki sterylizacyjne, aby uniknąć zakażeń, niesterylne.

Pack of 10 pieces / Opak. 10 szt.



Rectangle / prostokątne

	Upper / Góra	Lower / Dół	Upper / Góra	Lower / Dół
.014" x .025"	DL301052-E	DL301064-E	DL301052	DL301064
.016" x .022"	DL301054-E	DL301066-E	DL301054	DL301066
.016" x .025"	DL301055-E	DL301067-E	DL301055	DL301067
.017" x .022"	DL301056-E	DL301068-E	DL301056	DL301068
.017" x .025"	DL301057-E	DL301069-E	DL301057	DL301069
.018" x .022"	DL301059-E	DL301071-E	DL301059	DL301071
.018" x .025"	DL301060-E	DL301072-E	DL301060	DL301072
.019" x .025"	DL301061-E	DL301073-E	DL301061	DL301073
.021" x .025"	DL301063-E	DL301075-E	DL301063	DL301075

Square / kwadratowe

	Upper / Góra	Lower / Dół	Upper / Góra	Lower / Dół
.016" x .016"	DL301053-E	DL301065-E	DL301053	DL301065
.018" x .018"	DL301058-E	DL301070-E	DL301058	DL301070
.020" x .020"	DL301062-E	DL301074-E	DL301062	DL301074

Rectangle / prostokątne

	Universal / Uniwersalne
.014" x .025"	DL301252
.016" x .022"	DL301254
.016" x .025"	DL301255
.017" x .022"	DL301256
.017" x .025"	DL301257
.018" x .022"	DL301259
.018" x .025"	DL301260
.019" x .025"	DL301261
.021" x .025"	DL301263

Square / kwadratowe

	Universal / Uniwersalne
.016" x .016"	DL301253
.018" x .018"	DL301258
.020" x .020"	DL301262

SANI-PAK

Aesthetic Micro-Coated Archwires

Łuki estetyczne pokryte mikro-warstwą

The perfect combination of aesthetics and functionality
Micro coating is only done on labial surface of archwire to reduce friction and improve sliding mechanics compared to fully coated wire.

True archwire size because coating is only .0005" thick compared to .002" of competitive brands.

The coating is resistant to staining and cracking even if the archwire shape is changed.

All Micro-Coated Archwires are individually packaged & sealed in an autoclavable pack to protect your patients from cross infection.

Doskonale połączenie estetyki i funkcjonalności.

Łuki pokryte mikro-warstwą, mikro tylko od strony wargowej, redukują tarcie oraz zapewniają swobodniejsze umieszczenie łuku niż tradycyjne łuki powlekane.

"Prawdziwy" rozmiar łuku ponieważ pokrycie wynosi .0005" w porównaniu do innych łuków, których pokrycie wynosi .002"

Pokrycie jest odporne na plamy i zadrapania, nawet gdy kształt łuku ulegnie zmianie.

Wszystkie łuki pokryte mikro-warstwą są pakowane osobno, niesterylne.



Invisa-Temp[™] Micro Coated

Tooth-Tone micro coated NiTi thermal archwires

Łuki NiTi termalne kosmetyczne pokryte mikro-warstwą

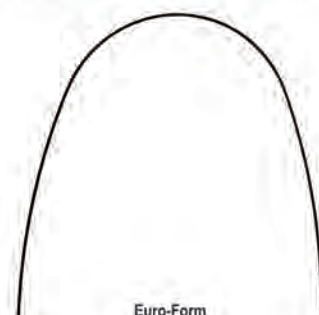

Round / okrągłe

Each / Sztuka

	Upper / Góra	Lower / Dół
.012"	DO.3900.12	DO.3901.12
.014"	DO.3900.14	DO.3901.14
.016"	DO.3900.16	DO.3901.16
.018"	DO.3900.18	DO.3901.18
.020"	DO.3900.20	DO.3901.20

Square / kwadratowe

	Upper / Góra	Lower / Dół
.016" x .016"	DO.3902.16	DO.3903.16

Rectangle / prostokątne

	Upper / Góra	Lower / Dół
.016" x .022"	DO.3904.62	DO.3907.62
.017" x .025"	DO.3904.75	DO.3907.75
.018" x .025"	DO.3904.85	DO.3907.85
.019" x .025"	DO.3904.95	DO.3907.95
.021" x .025"	DO.3905.15	DO.3908.15

UltiMax™

Stainless steel archwires / Łuki stalowe

UltiMax Solid Stainless Steel archwires are produced of high quality medical grade Type 304VSS material with highly polished surfaces to provide reduced friction between bracket and arch. Their high forces are well-suited for stabilizing positioned teeth during mid- to late stages of treatment. Rectangular wires offer precise torque control for these same stages. Solid Stainless Steel Lengths (14") produced of high quality Type 302SS material have a smooth finish and are available in a wide range of wire sizes for custom appliance fabrication.

- Superior smooth, bright finish.
- Precise shape and flatness of arches is ensured through tight production control.
- Best suited as finishing wire, as forces drop quickly as teeth move.
- Easy bend placement.
- Good corrosion resistance.



Made in USA

Pack of 10 pieces / Opak. 10 szt.

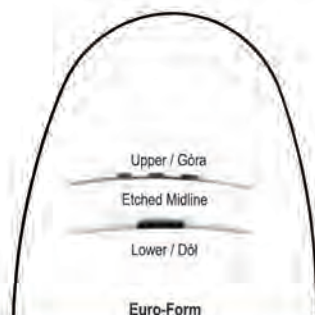

Euro-Form

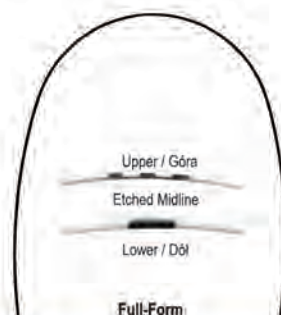

Full-Form

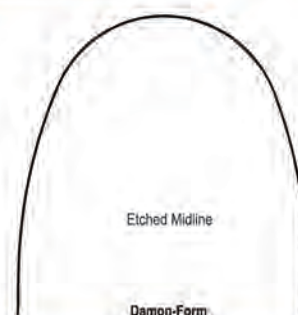

Damon-Form

Round / okrągłe

	Upper / Góra	Lower / Dół	Upper / Góra	Lower / Dół	Universal / Uniwersalne
.012"	DO.4100.12	DO.4101.12	DO.4110.12	DO.4111.12	DO.4130.12
.014"	DO.4100.14	DO.4101.14	DO.4110.14	DO.4111.14	DO.4130.14
.016"	DO.4100.16	DO.4101.16	DO.4110.16	DO.4111.16	DO.4130.16
.018"	DO.4100.18	DO.4101.18	DO.4110.18	DO.4111.18	DO.4130.18
.020"	DO.4100.20	DO.4101.20	DO.4110.20	DO.4111.20	DO.4130.20

Square / kwadratowe

	Upper / Góra	Lower / Dół	Upper / Góra	Lower / Dół	Universal / Uniwersalne
.016" x .016"	DO.4102.16	DO.4103.16	DO.4112.16	DO.4113.16	DO.4132.16
.018" x .018"	DO.4102.18	DO.4103.18	DO.4112.18	DO.4113.18	DO.4132.16

Rectangle / prostokątne

	Upper / Góra	Lower / Dół	Upper / Góra	Lower / Dół	Universal / Uniwersalne
.016" x .022"	DO.4104.62	DO.4107.62	DO.4114.62	DO.4117.62	DO.4134.62
.017" x .022"	DO.4104.72	DO.4107.72	DO.4114.72	DO.4117.72	DO.4134.72
.017" x .025"	DO.4104.75	DO.4107.75	DO.4114.75	DO.4117.75	DO.4134.75
.018" x .022"	DO.4104.82	DO.4107.82	DO.4114.82	DO.4117.82	DO.4134.82
.018" x .025"	DO.4104.85	DO.4107.85	DO.4114.85	DO.4117.85	DO.4134.85
.019" x .025"	DO.4104.95	DO.4107.95	DO.4114.95	DO.4117.95	DO.4134.95
.021" x .025"	DO.4105.15	DO.4108.15	DO.4115.15	DO.4118.15	DO.4135.15

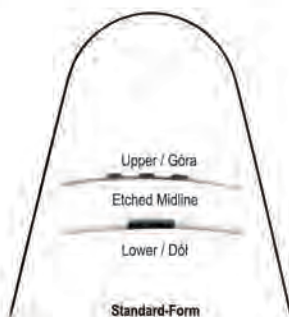

Standard-Form

Pack of 10 pieces / Opak. 10 szt.



Round / okrągłe

	Upper / Góra	Lower / Dół	Square / kwadratowe	Rectangle / prostokątne
.012"	DO.4120.12	DO.4121.12	DO.4122.16	DO.4124.62
.014"	DO.4120.14	DO.4121.14	DO.4122.18	DO.4124.72
.016"	DO.4120.16	DO.4121.16		DO.4124.75
.018"	DO.4120.18	DO.4121.18		DO.4124.82
.020"	DO.4120.20	DO.4121.20		DO.4124.85

Square / kwadratowe

	Upper / Góra	Lower / Dół	Rectangle / prostokątne
			DO.4127.62
			DO.4127.72
			DO.4127.75
			DO.4127.82
			DO.4127.85
			DO.4127.95
			DO.4128.15

Rectangle / prostokątne

	Upper / Góra	Lower / Dół
		DO.4127.62
		DO.4127.72
		DO.4127.75
		DO.4127.82
		DO.4127.85
		DO.4127.95
		DO.4128.15



Stainless steel archwires / Łuki stalowe

High quality wires

Individually packed in sterilization pouch to protect against cross infection, non-sterile.

Wysokiej jakości łuki

Pakowane osobno w torebki sterylizacyjne, aby uniknąć zakażeń, niesterylne.

Pack of 10 pieces / Opak. 10 szt.

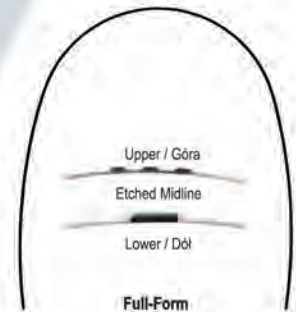

Round / okrągłe

	Upper / Góra	Lower / Dół	Upper / Góra	Lower / Dół
.012"	DL304001-E	DL304006-E	DL304001	DL304006
.014"	DL304002-E	DL304007-E	DL304002	DL304007
.016"	DL304003-E	DL304008-E	DL304003	DL304008
.018"	DL304004-E	DL304009-E	DL304004	DL304009
.020"	DL304005-E	DL304010-E	DL304005	DL304010

Rectangle / prostokątne

	Upper / Góra	Lower / Dół	Upper / Góra	Lower / Dół
.016" x .022"	DL304013-E	DL304025-E	DL304013	DL304025
.017" x .025"	DL304016-E	DL304028-E	DL304016	DL304028
.018" x .025"	DL304018-E	DL304030-E	DL304018	DL304030
.019" x .025"	DL304020-E	DL304032-E	DL304020	DL304032
.021" x .025"	DL304022-E	DL304034-E	DL304022	DL304034

UltiMax Brass Post

Stainless steel brass posted archwires

Łuki ze słupkami

Stainless Steel Retraction Archwires

- Anterior retraction
- Anterior intrusion
- Space closure
- Elastic engagement
- Custom formed to exact measurements
- 304 medical grade Stainless Steel

Stalowe łuki rozwierające ze słupkami są stosowane do:

- Skracania zębów przednich
- Zamykania przestrzeni międzyzębowych
- Cołania zębów przednich
- Produkowane z doskonałej stali medycznej 304v

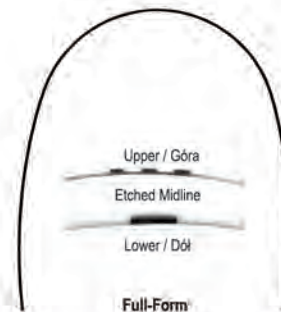

Post or Loop Measurement Measure along incisal edge from distal of lateral to distal of opposite lateral



Rectangle / prostokątne

	.016" x .022"	.017" x .025"	.018" x .025"	.019" x .025"
34 mm	DO.4234.62	DO.4234.75	DO.4234.85	DO.4234.95
36 mm	DO.4236.62	DO.4236.75	DO.4236.85	DO.4236.95
38 mm	DO.4238.62	DO.4238.75	DO.4238.85	DO.4238.95
40 mm	DO.4240.62	DO.4240.75	DO.4240.85	DO.4240.95
42 mm	DO.4242.62	DO.4242.75	DO.4242.85	DO.4242.95

Rectangle / prostokątne

	.016" x .022"	.017" x .025"	.018" x .025"	.019" x .025"
24 mm	DO.4224.62	DO.4224.75	DO.4224.85	DO.4224.95
26 mm	DO.4226.62	DO.4226.75	DO.4226.85	DO.4226.95
28 mm	DO.4228.62	DO.4228.75	DO.4228.85	DO.4228.95
30 mm	DO.4230.62	DO.4230.75	DO.4230.85	DO.4230.95
32 mm	DO.4232.62	DO.4232.75	DO.4232.85	DO.4232.95



UltiMax 2keyhole

2 keyhole looped archwires
Łuki retrakcyjne z pętlami podwójne

- Stainless Steel Retraction Archwires
- Anterior retraction
 - Anterior intrusion
 - Space closure
 - Elastic engagement
 - Custom formed to exact measurements
 - 304 medical grade Stainless Steel

- Stalowe łuki rozwierające 2-Loop są stosowane do:
- Skracania zębów przednich
 - Zamykania przestrzeni międzyzębowych
 - Cofania zębów przednich
 - Produkowane z doskonałej stali medycznej 304v

Post or Loop Measurement Measure along incisal edge from distal of lateral to distal of opposite lateral



Rectangle / prostokątne	Upper / Góra		
<input type="checkbox"/>	.016" x .022"	.017" x .025"	.019" x .025"
34 mm	DO.4334.62	DO.4334.75	DO.4334.95
36 mm	DO.4336.62	DO.4336.75	DO.4336.95
38 mm	DO.4338.62	DO.4338.75	DO.4338.95
40 mm	DO.4340.62	DO.4340.75	DO.4340.95
42 mm	DO.4342.62	DO.4342.75	DO.4342.95

Rectangle / prostokątne	Lower / Dół		
<input type="checkbox"/>	.016" x .022"	.017" x .025"	.019" x .025"
24 mm	DO.4324.62	DO.4324.75	DO.4224.95
26 mm	DO.4326.62	DO.4326.75	DO.4226.95
28 mm	DO.4328.62	DO.4328.75	DO.4228.95
30 mm	DO.4330.62	DO.4330.75	DO.4230.95
32 mm	DO.4332.62	DO.4332.75	DO.4232.95

UltiMax 4keyhole

4 keyhole looped archwires
Łuki retrakcyjne z pętlami poczwórne

- Stainless Steel Retraction Archwires
- Anterior retraction
 - Anterior intrusion
 - Space closure
 - Elastic engagement
 - Custom formed to exact measurements
 - 304 medical grade Stainless Steel

- Stalowe łuki rozwierające 4-Loop są stosowane do:
- Skracania zębów przednich
 - Zamykania przestrzeni międzyzębowych
 - Cofania zębów przednich
 - Produkowane z doskonałej stali medycznej 304v

Post or Loop Measurement Measure along incisal edge from distal of lateral to distal of opposite lateral



Rectangle / prostokątne	Upper / Góra		
<input type="checkbox"/>	.016" x .022"	.017" x .025"	.019" x .025"
34 mm	DO.4434.62	DO.4434.75	DO.4434.95
36 mm	DO.4436.62	DO.4436.75	DO.4436.95
38 mm	DO.4438.62	DO.4438.75	DO.4438.95
40 mm	DO.4440.62	DO.4440.75	DO.4440.95
42 mm	DO.4442.62	DO.4442.75	DO.4442.95

Rectangle / prostokątne	Lower / Dół		
<input type="checkbox"/>	.016" x .022"	.017" x .025"	.019" x .025"
24 mm	DO.4424.62	DO.4424.75	DO.4424.95
26 mm	DO.4426.62	DO.4426.75	DO.4426.95
28 mm	DO.4428.62	DO.4428.75	DO.4428.95
30 mm	DO.4430.62	DO.4430.75	DO.4430.95
32 mm	DO.4432.62	DO.4432.75	DO.4432.95

UltiMax T-Loop

T looped archwires
Łuki retrakcyjne z pętlami T podwójne

- Stainless Steel Retraction Archwires
- Anterior retraction
 - Anterior intrusion
 - Space closure
 - Elastic engagement
 - Custom formed to exact measurements
 - 304 medical grade Stainless Steel

- Stalowe łuki rozwierające T-Loop są stosowane do:
- Skracania zębów przednich
 - Zamykania przestrzeni międzyzębowych
 - Cofania zębów przednich
 - Produkowane z doskonałej stali medycznej 304v

Post or Loop Measurement Measure along incisal edge from distal of lateral to distal of opposite lateral



Rectangle / prostokątne	Upper / Góra		
<input type="checkbox"/>	.016" x .022"	.017" x .025"	.019" x .025"
34 mm	DO.4534.62	DO.4534.75	DO.4534.95
36 mm	DO.4536.62	DO.4536.75	DO.4536.95
38 mm	DO.4538.62	DO.4538.75	DO.4538.95
40 mm	DO.4540.62	DO.4540.75	DO.4540.95
42 mm	DO.4542.62	DO.4542.75	DO.4542.95

Rectangle / prostokątne	Lower / Dół		
<input type="checkbox"/>	.016" x .022"	.017" x .025"	.019" x .025"
24 mm	DO.4524.62	DO.4524.75	DO.4524.95
26 mm	DO.4526.62	DO.4526.75	DO.4526.95
28 mm	DO.4528.62	DO.4528.75	DO.4528.95
30 mm	DO.4530.62	DO.4530.75	DO.4530.95
32 mm	DO.4532.62	DO.4532.75	DO.4532.95

UltiMax 8

8 Strand twist stainless steel archwires
Łuki stalowe plecione 8-nitkowe

- Stable for finishing and holding
- 302SS Stainless Steel
- Gentle force levels with excellent torque control
- Smooth bright finish
- Does not unravel when cut
- Etched midline

- Stabilizuje uzębienie w końcowej fazie leczenia i w fazie retencji
- Ze stali typu 302SS
- Oddziałuje delikatnymi siłami przy znakomitej kontroli toroku
- Wykończony gładkim polerowaniem
- Zaznaczony środek łuku
- Nie rozplątuje się po przecięciu



Rectangle / prostokątne	Square / kwadratowe		Upper / Góra
<input type="checkbox"/>	Upper / Góra	<input type="checkbox"/>	Upper / Góra
.016" x .022"	DO.4834.62	.016" x .016"	DO.4832.16
.017" x .025"	DO.4834.75		
.018" x .025"	DO.4834.85		
.019" x .025"	DO.4834.95		
.021" x .025"	DO.4835.15		

Rectangle / prostokątne	Square / kwadratowe		Lower / Dół
<input type="checkbox"/>	Lower / Dół	<input type="checkbox"/>	Lower / Dół
.016" x .022"	DO.4837.62	.016" x .016"	DO.4833.16
.017" x .025"	DO.4837.75		
.018" x .025"	DO.4837.85		
.019" x .025"	DO.4837.95		
.021" x .025"	DO.4837.15		



InvisaMax™

Tooth-Tone stainless steel archwires / Łuki stalowe kosmetyczne

The same great features as our InvisaMax stainless steel archwires with a durable tooth colored overcoat which offers superior aesthetics, stain resistance, and low friction.
Size shown is finished size. Tooth Tone coating adds .002" thickness to diameter

Odporne na przebarwienia łuki powlekane Tooth Tone zapewniają dużą estetykę oraz niskie tarcie. Rozmiar łuku zawiera pokrycie o grubości .002"



Pack of 2 pieces / Opak. 2 szt.



Full-Form

Round / okrągłe	Full-Form	
○	Upper / Góra	Lower / Dół
.014"	DO.4900.14	DO.4901.14
.016"	DO.4900.16	DO.4901.16
.018"	DO.4900.18	DO.4901.18
.020"	DO.4900.20	DO.4901.20
Square / kwadratowe	Upper / Góra	Lower / Dół
□		
.018" x .018"	DO.4902.18	DO.4903.18
.020" x .020"	DO.4902.20	DO.4903.20
Rectangle / prostokątne	Upper / Góra	Lower / Dół
▭		
.016" x .022"	DO.4904.62	DO.4907.62
.018" x .025"	DO.4904.84	DO.4907.84
.019" x .025"	DO.4904.97	DO.4907.97
.021" x .025"	DO.4905.17	DO.4908.17

SANI-PAK

Aesthetic Micro-Coated Archwires Łuki estetyczne pokryte mikro-warstwą

The perfect combination of aesthetics and functionality
Micro coating is only done on labial surface of archwire to reduce friction and improve sliding mechanics compared to fully coated wire.

True archwire size because coating is only .0005" thick compared to .002" of competitive brands.

The coating is resistant to staining and cracking even if the archwire shape is changed.

All Micro-Coated Archwires are individually packaged & sealed in an autoclavable pack to protect your patients from cross infection.

Doskonale połączenie estetyki i funkcjonalności.
Łuki pokryte mikro-warstwą, mikro tylko od strony wargowej, redukują tarcie oraz zapewniają swobodniejsze umieszczenie łuku niż tradycyjne łuki powlekane.

"Prawdziwy" rozmiar łuku ponieważ pokrycie wynosi .0005" w porównaniu do innych łuków, których pokrycie wynosi .002"

Pokrycie jest odporne na plamy i zadrapania, nawet gdy kształt łuku ulegnie zmianie.

Wszystkie łuki pokryte mikro-warstwą są pakowane osobno, niesterylne.



InvisaMax™ Micro Coated

Tooth-Tone micro coated stainless steel archwires Łuki stalowe kosmetyczne pokryte mikro-warstwą



Made in USA

Each / Sztuka

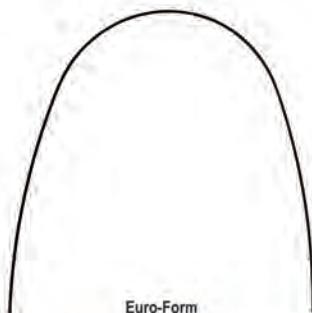

Euro-Form

Round / okrągłe	Upper / Góra		Lower / Dół	
○				
.012"	DO.4920.12	DO.4921.12	DO.4921.12	DO.4921.12
.014"	DO.4920.14	DO.4921.14	DO.4921.14	DO.4921.14
.016"	DO.4920.16	DO.4921.16	DO.4921.16	DO.4921.16
.018"	DO.4920.18	DO.4921.18	DO.4921.18	DO.4921.18
.020"	DO.4920.20	DO.4921.20	DO.4921.20	DO.4921.20
Square / kwadratowe	Upper / Góra	Lower / Dół		
□				
.016" x .016"	DO.4922.16	DO.4923.16	DO.4923.16	DO.4923.16
Rectangle / prostokątne	Upper / Góra	Lower / Dół		
▭				
.016" x .022"	DO.4924.62	DO.4927.62	DO.4927.62	DO.4927.62
.017" x .025"	DO.4924.75	DO.4927.75	DO.4927.75	DO.4927.75
.018" x .025"	DO.4924.85	DO.4927.85	DO.4927.85	DO.4927.85
.019" x .025"	DO.4924.95	DO.4927.95	DO.4927.95	DO.4927.95
.021" x .025"	DO.4925.15	DO.4928.15	DO.4928.15	DO.4928.15

UltiMax 3

3 Strand twist stainless steel archwires Łuki stalowe plecione 3-nitkowe



Made in USA

Pack of 10 pieces / Opak. 10 szt.

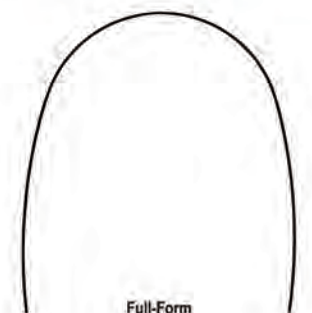

Full-Form

- Light force levels with good flexibility
- 302SS Stainless Steel
- Smooth bright finish

- Pleciony z trzech drucików
- Niski poziom siły z wysoką elastycznością
- Wykonany ze stali medycznej 302SS



Round / okrągłe	Upper / Góra		Lower / Dół	
○				
.0155"	DO.4820.15	DO.4821.15	DO.4821.15	DO.4821.15
.0175"	DO.4820.17	DO.4821.17	DO.4821.17	DO.4821.17
.0195"	DO.4820.19	DO.4821.19	DO.4821.19	DO.4821.19

UltiMax 6

6 Strand twist stainless steel archwires
Łuki stalowe plecione 6-nitkowe



Made in USA

- Light force levels with good flexibility
- 302S Stainless Steel
- Smooth bright finish

- Pleciony z sześciu drucików
- Wypolerowany na połysk
- Wykonany ze stali medycznej 302SS
- Niski poziom siły z wysoką elastycznością

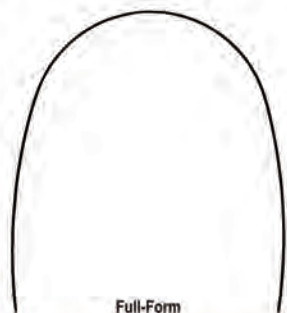

Full-Form

Pack of 10 pieces / Opak. 10 szt.



Round / okrągłe

	Upper / Góra	Lower / Dół
.0155"	DO.4830.15	DO.4831.15
.0175"	DO.4830.17	DO.4831.17
.0195"	DO.4830.19	DO.4831.19

Bio-B³

Beta titanium archwires / Łuki Beta-Tytanowe



Made in USA

Włączenie miedzi do stopu nikowo-tytanowego uwydatnia termalne właściwości i charakterystykę pracy tych łuków. Mniejsza histereza łuków Copper powoduje, że w temperaturze pokojowej są one bardziej „wyczuwalne”, co przekłada się na dodatkową elastyczność, czyli łatwiejsze umieszczanie w przypadku słoczeń. Stop o unikalnej kompozycji ułatwia umieszczanie łuków w słoczkach oraz sprawia, że są one odporniejsze na deformację. Łuki Bio B 3 Copper działają z kontrolowaną siłą przez dłuższy czas, dzięki czemu rzadziej można je wymieniać. Te kontrolowane poziomy siły przekładają się także na delikatne i stałe naciski, dostarczając przewidywalne w trakcie całego leczenia przemieszczenia zębów.

Dostępne w wersjach 27° C lub 35° C
• 27° C
• Większa siła działania
• 35° C
• Mniejsza siła działania

Round / okrągłe

	Upper / Góra	Lower / Dół
.016"	DO.3000.16	DO.3001.16
.018"	DO.3000.18	DO.3001.18

Square / kwadratowe

	Upper / Góra	Lower / Dół
.018" x .018"	DO.3002.18	DO.3003.18

Rectangle / prostokątne

	Upper / Góra	Lower / Dół
.016" x .022"	DO.3004.62	DO.3007.62
.017" x .025"	DO.3004.75	DO.3007.75
.018" x .025"	DO.3004.85	DO.3007.85
.019" x .025"	DO.3004.95	DO.3007.95
.021" x .025"	DO.3005.15	DO.3008.15



Nickel Free
Bezniklowe

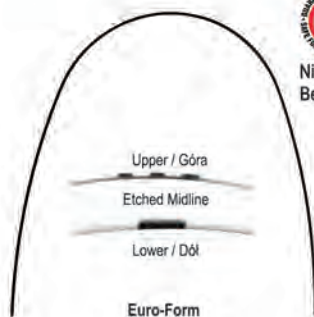

Pack of 2 pieces / Opak. 2 szt.



UltiMax™

Stainless steel wires, straight lengths
Drut stalowy w sztandze



Made in USA

- 302SS Stainless Steel
- Made in the USA
- Smooth bright finish



Round / okrągłe	Square / kwadratowe	Rectangle / prostokątne	
.012"	DO.4280.12	.016" x .022"	DO.4282.62
.014"	DO.4280.14	.016" x .016"	DO.4281.16
.016"	DO.4280.16	.018" x .018"	DO.4281.18
.018"	DO.4280.18	.016" x .022"	DO.4282.75
.020"	DO.4280.20	.017" x .025"	DO.4282.85
		.018" x .025"	DO.4282.95
		.019" x .025"	DO.4282.85
		.021" x .025"	DO.4283.15

14" (356mm) long, pack of 25 pieces / 14" (356mm) długość, opak. 25 szt.

Crimpable tubes and stops Zaciskane stopery na łuk



Pack of 10 pieces
Opak. 10 szt.

Code / Kod	Size / Rozmiar
DO.5330.01	0.30 x 2.0mm, 0.022"
DO.5330.03	0.30 x 2.2mm, 0.022"



Pack of 10 pieces
Opak. 10 szt.

Code / Kod	Size / Rozmiar
DO.5331.01	0.015", 2mm
DO.5331.02	0.019", 2mm



Pack of 5 pieces
Opak. 5 szt.

Code / Kod	Size / Rozmiar
DO.5332.01	0.022"



Australian wire in spool / Druty australijskie

The wires on this page are listed in order of resilience. The Regular and Regular Plus are easily formed and are excellent wires for general use and utility wires. The Special, Special Plus and Premium wires are ideal for bite opening and where high resilience is required. The finer wires such as Premium Plus and Supreme are ideal for auxiliaries.

Drut australijski - stworzony przez firmę A. J. Wilcock Co. drut australijski doskonale nadaje się do prowadzenia leczenia ortodontycznego. Cechuje go wysoka wytrzymałość i zwiększona sprężystość.

A. J. Wilcock Cock oferuje całą gamę rozmiarów drutu australijskiego oraz jego różnych kategorii:

- Regular Pink
- Regular+ Green
- Special Blue
- Special+ Yellow
- Premium Purple
- Premium+ Gold
- Premium+ Pulse

W zależności od wybranego rodzaju drut australijski nadaje się do ogólnych zastosowań, jako element pomocniczy w leczeniu, do otwierania zgryzu i w przypadkach gdzie wymagana jest duża odporność drutu.



7.6 m wire spool

Round / okrągłe

	Regular	Regular +	Special	Special +	Premium	Premium +	Supreme
.008"	x	x	x	x	x	x	DL320037
.009"	x	x	x	x	x	x	DL320034
.010"	x	x	x	x	x	DL320028	DL320035
.011"	x	x	x	x	x	DL320029	DL320036
.012"	DL320001	DL320006	DL320011	DL320016	DL320023	DL320030	x
.014"	DL320002	DL320007	DL320012	DL320017	DL320024	DL320031	x
.016"	DL320003	DL320008	DL320013	DL320018	DL320025	DL320032	x
.018"	DL320004	DL320009	DL320014	DL320019	DL320026	DL320033	x
.020"	DL320005	DL320010	DL320015	DL320020	DL320027	x	x
.022"	DL320038	x	x	DL320021	x	x	x
.024"	DL320039	x	x	DL320022	x	x	x



Mini Titan

Crimpable stops for archwires / Zaciskane stopery na łuk

Made of 100% pure titanium / Wykonane z czystego tytanu 100%

Pack of 20 pieces / Opak. 20 szt

Closed / Zamknięte

For round wires / Na łuki okrągłe

.010" - .016"	DL500033
.016" - .020"	DL500052



For rectangular wires / Na łuki prostokątne

.014"x.025" - .020"x.020"	DL500034
.016"x.025" - .021"x.025"	DL500053

Open / Otwarte

For round wires / Na łuki okrągłe

.010" - .025"	DL500066
---------------	----------



For rectangular wires / Na łuki prostokątne

.014"x.025" - .021"x.025"	DL500054
---------------------------	----------

Crimpable stops for archwires / Zaciskane stopery na łuk



DL500032
Pack of 10 pieces
Opak. 10 szt

**Disposable archwire markers
Jednorazowe oznaczniki do łuków**



DO.5395.01 Markers without dispenser / Oznaczniki bez dozownika
(Pack of 100 / Opak. 100 szt.)

DO.5395.02 Empty Dispenser / Dozownik

**Crimpable hooks
Zaciskane haczyki na łuk**

Pack of 10 pieces
Opak. 10 szt.



DO.5325.00
Short / Krótkie
.022", 1.4mm



DO.5325.02
Medium / Średnie
.022", 2.3mm



DO.5325.01
Long / Długie
.022", 3mm



DO.5325.11
Long / Długie
.022", 3mm



DO.5325.03 Left / Lewy
DO.5325.04 Right / Prawy
.022"x.025", 5.5mm



DO.5325.07 Left / Lewy
DO.5325.08 Right / Prawy
.022"x.025", 10mm



DO.5325.09 Left / Lewy
DO.5325.10 Right / Prawy
.022"x.025", 5.5mm



Crimpable ball hooks tooth tone
Haczyk z kuleczką zaciskany kosmetyczne



Pack of 10 pieces
Opak. 10 szt.



DO.5325.05
Short / Krótkie
.022"x.028", 2.3mm

DO.5325.06
Long / Długie
.022"x.028", 4mm

MaxiFlex™

NiTi preformed open coil springs
Sprężyny otwarte Niklowo-Tytanowe



Made in USA



15mm long / 15mm długość

Force/Siła	Wire / Drut Ø		Inside / Przekrój Ø		Code/Kod
	Inches/Cale	mm	Inches/Cale	mm	
100gm	.009"	.23	.035"	.89	DO.5109.01
150gm	.010"	.25	.035"	.89	DO.5109.02
200gm	.011"	.28	.035"	.89	DO.5109.03

Pack of 10 pieces / Opak. 10 szt.

MaxiFlex™

NiTi open coil springs / Sprężyny otwarte Niklowo-Tytanowe



Force/Siła	Wire / Drut Ø		Inside / Przekrój Ø		Code/Kod
	Inches/Cale	mm	Inches/Cale	mm	
	.010"	.25	.030"	.76	DO.5110.01
	.012"	.30	.030"	.76	DO.5110.02
	.014"	.36	.036"	.91	DO.5110.03

7" (180mm) long, pack of 3 pieces / 7" (180mm) długość, opak. 3 szt.

MaxiFlex™

NiTi open coil springs / Sprężyny otwarte Niklowo-Tytanowe



Made in USA



Force/Siła	Wire / Drut Ø		Inside / Przekrój Ø		Code/Kod
	Inches/Cale	mm	Inches/Cale	mm	
	.010"	.25	.030"	.76	DO.5111.01
	.012"	.30	.030"	.76	DO.5111.02

15" (380mm) spool / 15" (380mm) szpula

MaxiFlex™

NiTi distalizing springs
Sprężynki niklowo-tytanowe do dystalizacji zębów trzonowych

- Dystalizują trzonowce bez konieczności stosowania akcesoriów zewnątrzustnych
- Oddziałują siłą 140 g w przypadku 3 segmentów
- Dystalizacja rzędu 1mm do 1.5 mm w ciągu miesiąca
- Pasują do każdego rozmiaru łuku
- Czym dłuższa jest sprężynka tym mniejsza jest jej siła



Force/Siła	Wire / Drut Ø		Inside / Przekrój Ø		Code/Kod
	Inches/Cale	mm	Inches/Cale	mm	
	.010"	.25	.045"	1.14	DO.5115.01

7" (180mm) long, pack of 3 pieces
7" (180mm) długość, opak. 3 szt.

MaxiFlex™

NiTi closed coil springs
Sprężyny zamknięte Niklowo-Tytanowe



Made in USA

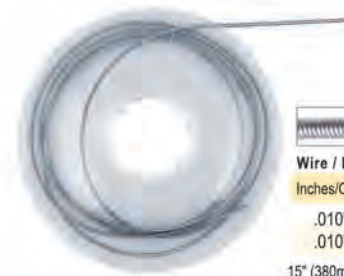

Force/Siła	Wire / Drut Ø		Inside / Przekrój Ø		Code/Kod
	Inches/Cale	mm	Inches/Cale	mm	
	.010"	.25	.030"	.76	DO.5125.01
	.010"	.25	.035"	.89	DO.5125.02

15" (380mm) spool / 15" (380mm) szpula

MaxiFlex™

NiTi closed coil springs with stainless steel eyelets
Sprężyny zamknięte Niklowo-Tytanowe z zaczepami



Force/Siła	Wire / Drut Ø		Inside / Przekrój Ø		Code/Kod	
	Inches/Cale	mm	Inches/Cale	mm		
9 mm	Light	.009"	.23	.030"	.76	DO.5150.90
	Medium	.010"	.25	.030"	.76	DO.5150.91
	Heavy	.011"	.28	.030"	.76	DO.5150.92

Pack of 2 pieces / Opak. 2 szt.

Force/Siła	Wire / Drut Ø		Inside / Przekrój Ø		Code/Kod	
	Inches/Cale	mm	Inches/Cale	mm		
12 mm	Light	.009"	.23	.030"	.76	DO.5151.20
	Medium	.010"	.25	.030"	.76	DO.5151.21
	Heavy	.011"	.28	.030"	.76	DO.5151.22

Pack of 2 pieces / Opak. 2 szt.

MaxiFlex™

Separating springs / Sprężynki separacyjne



DO.5172.01 Bicuspsids, small / Przedtrzonowce, małe
DO.5172.02 Molars, large / Trzonowce, duże
Pack of 5 pieces / Opak. 5 szt.

MaxiFlex™

NiTi separating and De-Impaction springs
Sprężynki rozklinowujące i separacyjne NiTi



De-Impaction / Rozklinowanie
DO.5170.01
.017" x .025"
Pack of 2 pieces / Opak. 2 szt.

Separating / Separacja
DO.5171.01 Narrow / Wąska
DO.5171.02 Wide / Szeroka
.016" x .022"
Pack of 2 pieces / Opak. 2 szt.

Rotating springs / Sprężyny do obracania zębów

Used to rotate individual teeth
Używane do obrotu pojedynczych zębów



DO.5180.01
Clockwise
Obrót zgodnie z ruchem wskazówek zegara

DO.5180.02
Anti-clockwise
Obrót przeciwny ruchowi wskazówek zegara
Pack of 2 pieces / Opak. 2 szt.

Uprighting springs Sprężyny do prostowania pochylonych zębów

Used to upright individual teeth mesiodistally
Do prostowania zębów mezjo-dystalnie



DO.5185.01
Clockwise
Obrót zgodnie z ruchem wskazówek zegara

DO.5185.02
Anti-clockwise
Obrót przeciwny ruchowi wskazówek zegara
Pack of 2 pieces / Opak. 2 szt.

UltiMax™

Stainless steel open coil springs / Sprężyny stalowe otwarte

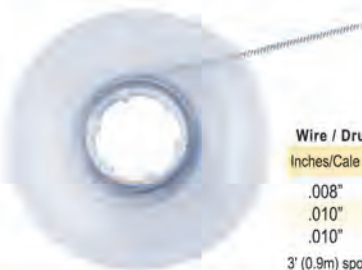

Wire / Drut Ø		Inside / Przekrój Ø		
Inches/Cale	mm	Inches/Cale	mm	Code/Kod
.008"	.20	.022"	.56	DO.5120.00
.010"	.25	.030"	.76	DO.5120.01
.010"	.25	.036"	.91	DO.5120.02

3' (0.9m) spool / 3' (0.9m) szpula

Ligature wire / Drut ligaturowy



Inches / Cale	mm	Code / Kod	Spool / Szula
.010"	.25	DO.5090.10	454g

UltiMax™

Stainless steel closed coil springs / Sprężyny stalowe zamknięte

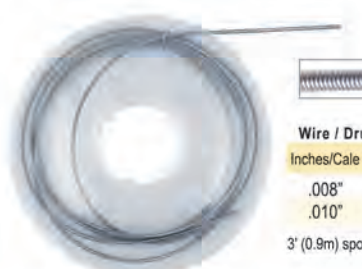

Wire / Drut Ø		Inside / Przekrój Ø		
Inches/Cale	mm	Inches/Cale	mm	Code/Kod
.008"	.20	.022"	.56	DO.5130.00
.010"	.25	.030"	.76	DO.5130.01

3' (0.9m) spool / 3' (0.9m) szpula

Preformed ligature ties short / Ligatury krótkie



Inches / Cale	mm	Code / Kod	Pieces / Szt.
.010"	.25	DO.5006.10	1000



Inches / Cale	mm	Code / Kod	Pieces / Szt.
.010"	.25	DO.5007.10	500



Inches / Cale	mm	Code / Kod	Pieces / Szt.
.010"	.25	DO.5008.10	500

Steiner rotation spring wedges Sprężyna Steiner



DO.5190.11
Pack of 10 pieces / Opak. 10 szt.

Ligature ties Kobayashi short / Ligatury Kobayashi krótkie



Inches / Cale	mm	Code / Kod	Pieces / Szt.
.012"	.30	DO.5001.12	100
.014"	.36	DO.5001.14	100

Ligature ties Kobayashi coated short
Ligatury kosmetyczne Kobayashi krótkie



Tooth Tone / kolorze zębów

Inches / Cale	mm	Code / Kod	Pieces / Szt.
.012"	.30	DO.5030.12	100

Preformed coated ligature ties short
Ligatury kosmetyczne krótkie



Tooth Tone / kolorze zębów

Inches / Cale	mm	Code / Kod	Pieces / Szt.
.012"	.30	DO.5020.12	100



White / Biały

Inches / Cale	mm	Code / Kod	Pieces / Szt.
.012"	.30	DO.5021.12	100

Preformed ligature ties long / Ligatury długie



Inches / Cale	mm	Code / Kod	Pieces / Szt.
.009"	.23	DO.5005.09	1000
.010"	.25	DO.5005.10	1000
.011"	.28	DO.5005.11	1000
.012"	.30	DO.5005.12	1000

Ligature ties Kobayashi long / Ligatury Kobayashi długie



Inches / Cale	mm	Code / Kod	Pieces / Szt.
.012"	.30	DO.5000.12	100
.014"	.36	DO.5000.14	100

Preformed coated ligature ties long
Ligatury kosmetyczne długie



Tooth Tone / kolorze zębów

Inches / Cale	mm	Code / Kod	Pieces / Szt.
.012"	.30	DO.5011.12	100

Tongue tamer bondable / Kolce językowe do przyklejania

Eliminates detrimental forces discourages over-active muscle activity
bonds to upper or lower arches 80 gauge foil mesh bonding base

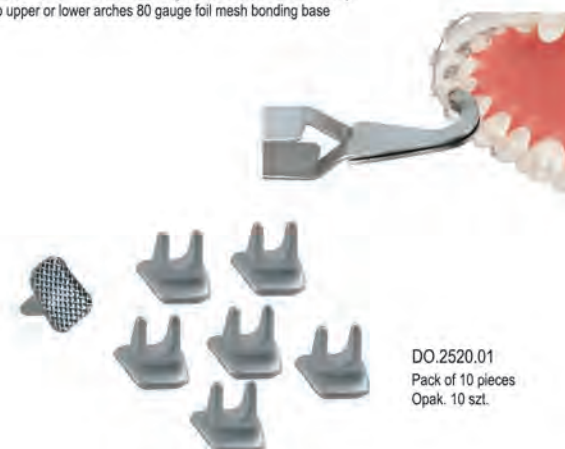

DO.2520.01
Pack of 10 pieces
Opak. 10 szt.

Tongue tamer bondable / Kolce językowe do przyklejania

Composite / kompozytowe



DO.2520.02
Pack of 10 pieces
Opak. 10 szt.

Lingual retainers bondable / Retainery językowe przyklejane



Pack of 5 pieces
Opak. 5 szt.

Mandibular / Żuchwa

Fig. 29	DO.5310.29
Fig. 31	DO.5310.31
Fig. 33	DO.5310.33
Fig. 35	DO.5310.35
Fig. 37	DO.5310.37

Maxillary / Szczęka

Fig. 38	DO.5315.38
Fig. 40	DO.5315.40
Fig. 42	DO.5315.42
Fig. 45	DO.5315.45
Fig. 47	DO.5315.47

UltiMax™
Palatal arch bars Goshgarian
Łuki Goshgarian

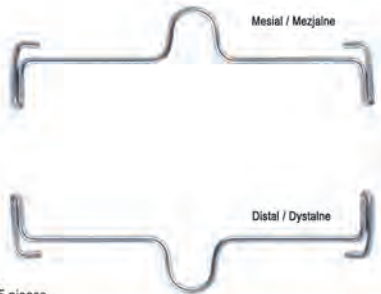

Pack of 5 pieces
Opak. 5 szt.

	Distal	Mesial
34mm	DO.5300.34	DO.5301.34
37mm	DO.5300.37	DO.5301.37
39mm	DO.5300.39	DO.5301.39
41mm	DO.5300.41	DO.5301.41
43mm	DO.5300.43	DO.5301.43
45mm	DO.5300.45	DO.5301.45
47mm	DO.5300.47	DO.5301.47
49mm	DO.5300.49	DO.5301.49
52mm	DO.5300.52	DO.5301.52
55mm	DO.5300.55	DO.5301.55

Lingual retainers bondable / Retainery językowe przyklejane

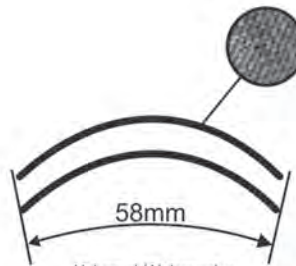

Universal / Uniwersalne

Ø 1.2 mm	DO.5319.12
Ø 2.0 mm	DO.5319.20



Pack of 5 pieces
Opak. 5 szt.

Lingual retainers bondable
Retainery językowe przyklejane

Pack of 5 pieces / Opak. 5 szt.



Maxillary lateral to lateral (2 x 2)
Szczęka - na siekacze boczne (2 x 2)

22 mm	DO.5316.22
24 mm	DO.5316.24
26 mm	DO.5316.26
28 mm	DO.5316.28
30 mm	DO.5316.30



Maxillary lateral to lateral (2 x 2)
Szczęka - na siekacze boczne (2 x 2)

14 mm	DO.5317.14
16 mm	DO.5317.16
18 mm	DO.5317.18

Stainless steel lingual retainer wire
Drut stalowe na retainery językowe płaski

Pack of 10 pieces
Opak. 10 szt.



DL390006

.010" x .028", 8 braid, 15cm, 6" / płaski .010" x .028" plecione 8-nitek 15cm, 6"

Titanium lingual retainer wire
Drut tytanowe na retainery językowe płaski

Pack of 10 pieces
Opak. 10 szt.



DL390007

Titanium .010" x .028", 15cm, 6" / Tytanowe płaski .010" x .028", 15cm, 6"

Pack of 10 pieces
Opak. 10 szt.



DL390008

Titanium .010" x .028", 3 braid, 15cm, 6" / Tytanowe płaski .010" x .028" plecione 3-nitek 15cm, 6"

Lingual retainer wire / Drut na retainery językowe płaski



DO.5320.00

.010" x .028", 6 braid, 15cm, 6"
płaski .010" x .028" plecione 6-nitek 15cm, 6"

Lingual retainer wire / Drut na retainery językowe płaski



DO.5320.01

CLOSE AND ACCURATE
ANATOMICAL ADAPTATION

The dead soft wire easily adapts and is excellent for semi-permanent orthodontic splinting of the upper and lower incisors, diastema maintenance and other tooth splinting

- Lingual retainer
- .027" x .011" ribbon arch wire
- 8-strand braided wire
- Dead soft – adapts easily

Lingual retainer wire / Drut na retainery językowe płaski



DO.5320.03

FIXED RETENTION WITH
TITANIUM MOLYBDENUM

CLINICAL APPLICATIONS

- Flat .027" x .016" ribbon arch
- Low profile – comfortable and functional
- Increased strength
- MRI compatible
- Easy adaptation
- Nickel free titanium construction

- Fixed lingual retention
- Diastema maintenance
- Space maintenance
- Splinting

Lingual retainer wire / Drut na retainery językowe płaski



DO.5320.02

LINGUAL TITANIUM
MOLYBDENUM RETENTION

CLINICAL APPLICATIONS

- Low profile
- .027" x .011" ribbon arch
- Adaptable
- Flexes Interproximally
- Nickel free
- MRI compatible

- Fixed lingual retention

Lingual retainer wire / Drut na retainery językowe płaski



DO.5320.04

A NEW flattened multi-strand wire for lingual retention. Dead soft to make it easier to adapt in the mouth. Its flat design ensures proper seating and will not rotate during bonding.
.010" x .029" dimensions
Contains (8) 8" strands

Grid for symmetric measurements /
Karta do pomiarów symetrycznych

Made of plexiglas, for symmetric measurements of dental arch on plaster casts, in millimetres.
Do symetrycznych pomiarów łuków zębowych na modelach gipsowych. Wykonana z plexiglasu.



DO.154.000

Wires organizers / Stojaki na łuki



DO.5390.00
197 x 95 x 94mm
Archwire organizer with cover



DO.5390.05
256 x 111 x 99mm
Archwire organizer with cover for square and round wires



DO.5390.03
200 x 100 x 99mm
Archwire organizer with cover for round wires



DO.5390.04
200 x 100 x 99mm
Archwire organizer with cover for square and rectangle wires

ElastoMAX™

Elastic ligatures Ligatury elastyczne



Made in USA

- High elasticity and fade resistant
- Excellent rebound
- Medical grade polyurethane
- Latex-free
- Nie zawierają lateksu i są hipoalergiczne
- Trwale, odporna na blaknięcie koloru
- Bardzo elastyczne - znakomicie spełniają swoją rolę
- Poliuretan klasy medycznej
- Kształt ułatwiający aplikację
- Zapewniona stała siła na długie okresy czasu



Bite size ties



Elast - o - ties

Colors / Kolory			
	Aqua / Turkus	DO.5516.17	x
	Baby blue / Błękitne	DO.5516.21	DO.5534.21
	Kelly green / Zieleń wiosenna	DO.5516.32	x
	Lilac / Fioletowe	DO.5516.61	x
	Red / Czerwone	DO.5516.47	x
	Royal blue / Niebieskie	DO.5516.13	DO.5534.13
	Baby pink / Jasnoróżowe	DO.5516.53	DO.5534.53
	Black / Czarne	DO.5516.09	x
	Magenta / Bordowy	x	x
	Marigold / Złoty metalik	x	x
	Sparkle blue / Niebieski metalik	DO.5512.13	x
	Sparkle green / Zielony metalik	x	x
	Caroline blue / Jasnoniebieskie	DO.5516.19	x
	Clear / Przezroczyste	DO.5516.01	x
	Midnight blue / Granatowe	x	DO.5534.01
	Ivory / W kolorze zębów	DO.5516.03	x
	Sparkle red / Czerwony metalik	DO.5516.89	DO.5535.47
	Silver / Srebrny metalik	DO.5516.87	DO.5535.04
	Coral / Fluorescencyjny czerwony	DO.5513.47	x
	Emerald green	x	x
	Neon green / Fluorescencyjny zielony	DO.5513.30	x
	Neon pink / Fluorescencyjny różowy	DO.5513.53	DO.5534.51
	Teal / Zielonomodry	x	x
	Fuchsia / Fuksja	DO.5516.55	x
	Glow in the dark / świecący klasyczny	DO.5516.01	x
	Orange / Pomarańczowe	DO.5516.70	x
	Pearl / Perłowe	DO.5510.01	DO.5533.01
	Turquoise / Morskie	DO.5516.25	x
	White / Białe	DO.5516.01	x
	Gold / Złoty	DO.5516.86	x
	Grey / Szare	DO.5516.05	x
	Periwinkle / Lawendowy	DO.5516.58	x
	Purple / Purpurowy	DO.5516.59	x
	Yellow / Żółte	DO.5516.77	x

10 ligatures per stick,
pack of 1000 ligatures
10 ligatury na pasku,
opak. 1000 ligatur

24 ligatures per stick,
pack of 1008 ligatures
24 ligatury na pasku,
opak. 1008 ligatur

84 ligatures per stick,
pack of 1008 ligatures
84 ligatury na pasku,
opak. 1008 ligatur

Mini elastic ligatures Ligatury elastyczne Mini

- .095 Diameter
- Stretchable Material
- Excellent Memory
- Great for Single or Small Brackets - Holds Tight
- Will Stretch around Various Size Brackets
- Will Return Near Original Size - Holding Tight Around Bracket



Made in USA

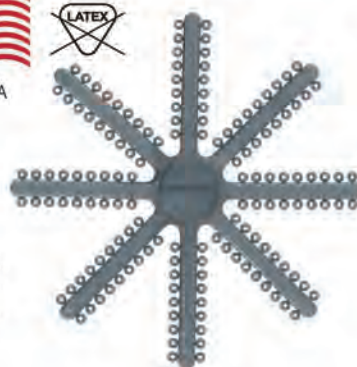

Colors / Kolory	Code / Kod
	Grey DO.5517.05
	Clear / Przezroczyste DO.5517.01
	Silver / Srebrny metalik DO.5517.04

144 ligatures per stick,
pack of 1008 ligatures
144 ligatury na pasku,
opak. 1008 ligatur



ElastoMAX™

- High elasticity and fade resistant
 - Excellent rebound
 - Medical grade polyurethane
 - Latex-free
 - Staly i odporny na blaknięcie kolor
 - Idealnie dopracowana elastyczność
 - Z wysokiej jakości poliuretanu
 - Bez lateksu
- A new revolutionary tie designed to apply either passive or active ligation using traditional twin brackets.
- When placed vertically, the wire is minimally pressed against the bracket which is useful during early treatment.
- When placed horizontally, the wire is fully engaged in the bracket for maximum control.



Made in USA



ACTIVE LIGATION



PASSIVE LIGATION

Colors / Kolory	Code / Kod
Aqua / Jasnoniebieski	DO.5518.17
Baby blue / Błękitny	DO.5518.21
Kelly green	DO.5518.34
Lilac	x
Red / Czerwone	DO.5518.47
Royal blue	DO.5518.13
Baby pink / Jasnorożowe	DO.5518.53
Black / Czarne	DO.5518.09
Caroline blue	x
Clear / Przezroczyste	DO.5518.01
Silver / Srebrny metalik	DO.5518.04
Neon green	DO.5518.30
Neon pink	DO.5518.51
Orange	DO.5518.70
Pearl / Perłowe	x
Turquoise	DO.5518.25
White	DO.5518.02
Grey	DO.5518.05
Purple	DO.5518.61
Yellow	DO.5518.77

10 ligatures per stick,
pack of 200 ligatures

10 ligatury na pasku,
opak. 200 ligatur



Figure 8 ties

ElastoMAX™

Sepo II Non-Radiopaque separators / Separatory Non-Radiopaque

The unique protection knobs are moulded lingually and labially to provide protection against sub-gingival loss. Additionally the knobs allow for easier removal prior to banding.

Smooth molded design for patient comfort

Non-Radiopaque: no barium sulphate to degrade the elastomeric memory

Latex Free: safe for sensitive patients

Po stronie językowej i przedsionkowej umieszczone są unikalne guziczki ochronne, które zapobiegają utracie tkanek poddziąsłowych. Ponadto guziczki te łatwiej się usuwa przed zakładaniem pierścieni.

Gładkie wykończenie dla komfortu pacjenta

Przepuszczalne dla promieni rentgenow-skich: nie zawierają siarczany baru, który pozbawia elastomery pamięci kształtu

Bez lateksu: bezpieczne dla wrażliwych pacjentów

Wyprodukowano w USA



Made in USA



DO.5818.01
Medium force
Pack of 960 pieces /
Opakowanie zawiera 960 sztuk



DO.5818.02
Heavy force
Pack of 960 pieces /
Opakowanie zawiera 960 sztuk

ElastoMAX™

Sepo I separators / Sepo I Separatorzy

.180" in diameter, these "non-latex" elastic separators have high strength and excellent memory, required for spacing teeth, ideal for posterior separator.



Made in USA

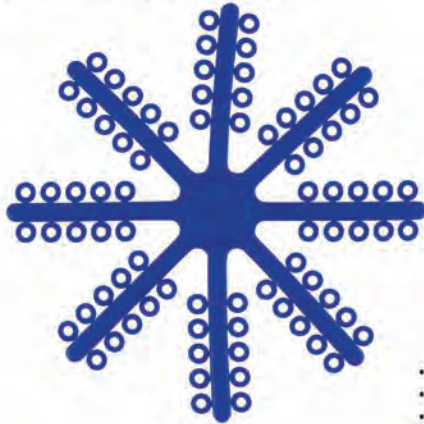

DR.5817.02
Pack of 960 pieces /
Opakowanie zawiera 960 sztuk

- Non-Radiopaque
- Niewidoczne na zdjęciach rentgenowskich
- Bez lateksu

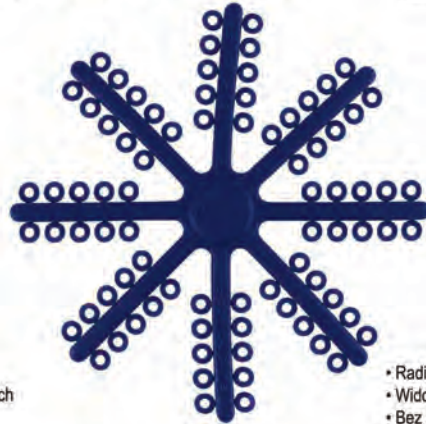

DR.5817.01
Pack of 960 pieces /
Opakowanie zawiera 960 sztuk

- Radiopaque
- Widoczne na zdjęciach rentgenowskich
- Bez lateksu

ElastoMAX™

Uno ligatures / Ligatury Uno

- High elasticity and fade resistant
- Excellent rebound
- Medical grade polyurethane
- Stały i odporny na blaknięcie kolor
- Idealnie dopracowana elastyczność
- Z wysokiej jakości poliuretanu

Colors / Kolory		Uno ligatures	Uno ligatures - I
	assorted / w różnych kolorach	DO.5500.00	DO.5503.00
	Aqua	DO.5500.17	DO.5503.17
	Baby blue	DO.5500.21	DO.5503.21
	Kelly green	DO.5500.34	DO.5503.34
	Lilac	DO.5500.60	DO.5503.60
	Red / Czerwone	DO.5500.47	DO.5503.47
	Royal blue	x	x
	Baby pink / Jasnoróżowe	DO.5500.53	DO.5503.53
	Black / Czarne	DO.5500.09	DO.5503.09
	Magenta	DO.5500.00	DO.5503.00
	Marigold / Złoty metalik	DO.5500.28	DO.5503.28
	Sparkle blue / Niebieski metalik	DO.5500.12	DO.5503.12
	Sparkle green /	x	x
	Caroline blue	x	x
	Clear / Przezroczyste	DO.5500.01	DO.5503.01
	Midnight blue	DO.5500.13	DO.5503.13
	Ivory / W kolorze zębów	DO.5500.03	DO.5503.03
	Sparkle red / Czerwony metalik	x	x
	Silver / Srebrny metalik	DO.5500.05	DO.5503.05
	Coral	x	x
	Emerald green	x	x
	Neon green	DO.5500.30	DO.5503.30
	Neon pink	DO.5500.51	DO.5503.51
	Teal	x	x
	Fuchsia / Fuksja	DO.5500.55	DO.5503.55
	Glow in the dark / świecący klasyczny	x	x
	Orange	DO.5500.70	DO.5503.70
	Pearl / Perłowe	x	x
	Turquoise	x	x
	White	DO.5500.02	DO.5503.02
	Gold	x	x
	Grey	x	x
	Periwinkle	x	x
	Purple	DO.5500.59	DO.5503.59
	Yellow	DO.5500.77	DO.5503.77

26 ligatures per stick,
pack of 1040 ligatures

26 ligatures per stick,
pack of 1040 ligatures

26 ligatury na pasku,
opak. 1040 ligatur

26 ligatury na pasku,
opak. 1040 ligatur



Uno ligatures



Uno ligatures - I

ElastoMAX™

Elastomeric chains / Łańcuszki elastyczne



4.5m per spool
4,5m na szpuli

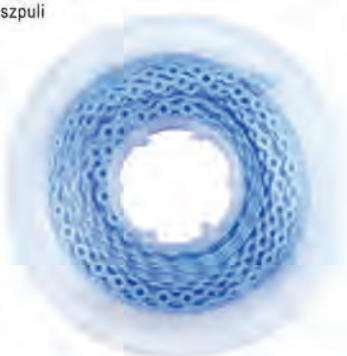

Made in USA

Latex Free / Bez lateksu

Standard

Closed
Ciągłe

Short
Krótkie

Long
Długie

Latex / z lateksu

Uno

Closed
Ciągłe

Short
Krótkie

Long
Długie



DO.5981.03

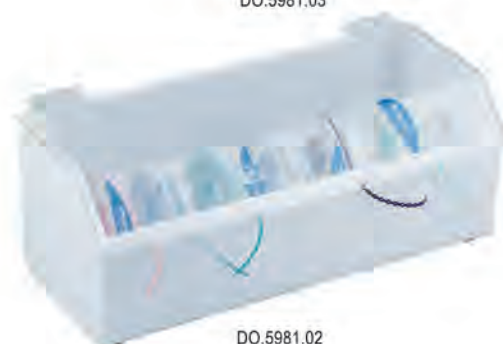

DO.5981.02

Colors / Kolory	Latex Free / Bez lateksu			Latex / z lateksu		
Aqua	x	x	DO.5741.25	x	x	x
Baby blue	DO.5711.21	DO.5721.21	DO.5741.21	DO.5760.21	DO.5770.21	DO.5780.21
Kelly green	x	x	x	DO.5760.34	DO.5770.34	DO.5780.34
Lilac	x	x	x	DO.5760.60	DO.5770.60	DO.5780.60
Red / Czerwone	DO.5711.47	DO.5721.47	DO.5741.47	DO.5760.47	DO.5770.47	DO.5780.47
Royal blue	x	x	x	x	x	x
Baby pink / Jasnoróżowe	DO.5711.53	DO.5721.53	DO.5741.53	DO.5760.53	DO.5770.53	DO.5780.53
Black / Czarne	DO.5711.09	DO.5721.09	DO.5741.09	DO.5760.09	DO.5770.09	DO.5780.09
Magenta	x	x	x	x	x	x
Marigold / Złoty metalik	x	x	x	x	x	x
Sparkle blue / Niebieski metalik	x	x	x	x	x	x
Sparkle green /	x	x	x	x	x	x
Caroline blue	x	x	x	x	x	x
Clear / Przezroczyste	DO.5711.01	DO.5721.01	DO.5741.01	DO.5760.01	DO.5770.01	DO.5780.01
Midnight blue	x	x	x	x	x	x
Ivory / W kolorze zębów	DO.5711.03	DO.5721.03	DO.5741.03	x	x	x
Sparkle red / Czerwony metalik	x	x	x	x	x	x
Silver / Srebrny metalik	DO.5711.05	DO.5721.05	DO.5741.05	DO.5760.05	DO.5770.05	DO.5780.05
Coral	x	x	x	x	x	x
Emerald green	x	x	x	x	x	x
Neon green	DO.5711.32	DO.5721.32	DO.5741.32	DO.5760.30	DO.5770.30	DO.5780.30
Neon pink	DO.5711.51	DO.5721.51	DO.5741.51	DO.5760.55	DO.5770.55	DO.5780.55
Teal	x	x	x	x	x	x
Fuchsia / Fuksja	x	x	x	DO.5760.51	DO.5770.51	DO.5780.51
Glow in the dark / świecący klasyczny	DO.5715.01	DO.5725.01	DO.5745.01	x	x	x
Orange	DO.5711.70	DO.5721.70	DO.5741.70	x	x	x
Pearl / Perłowe	DO.5710.01	DO.5720.01	DO.5740.01	x	x	x
Turquoise	DO.5711.25	DO.5721.25	DO.5741.25	x	x	x
White	DO.5711.02	DO.5721.02	DO.5741.02	x	x	x
Gold	x	x	x	x	x	x
Grey	x	x	x	x	x	x
Perlwinkle	x	x	DO.5741.58	x	x	x
Purple	DO.5711.59	DO.5721.59	DO.5741.59	DO.5760.61	DO.5770.61	DO.5780.61
Yellow	DO.5711.77	DO.5721.77	DO.5741.77	DO.5760.77	DO.5770.77	DO.5780.77

ElastoMAX™

Latex free elastomeric products
Produkty elastyczne bez lateksu

Elastic thread solid round
Nić elastyczna, okrągła pełna



Clear / Przezroczysta
.025" DO.5880.01
.030" DO.5881.01
Grey / Szara
.025" DO.5880.02
.030" DO.5881.02

7,5 m per spool / 7,5m na szpuli



Elastic thread hollow round
Nić elastyczna, okrągła pusta



Clear / Przezroczysta
.025" DO.5887.01
.030" DO.5888.01
Grey / Szara
.025" DO.5887.02
.030" DO.5888.02

7,5 m per spool / 7,5m na szpuli



Archwire sleeves
Osłonki na łuki



Clear / Przezroczysta
.018" DO.5892.01
.027" DO.5893.01
Grey / Szara
.018" DO.5892.02
.027" DO.5893.02

3 m per spool / 3m na szpuli



Lip bumper sleeves
Osłonki na pelotę wargową



Clear / Przezroczysta
.046" DO.5894.01
Grey / Szara
.046" DO.5894.02

3 m per spool / 3m na szpuli



Rotation wedges
Kliny rotacyjne

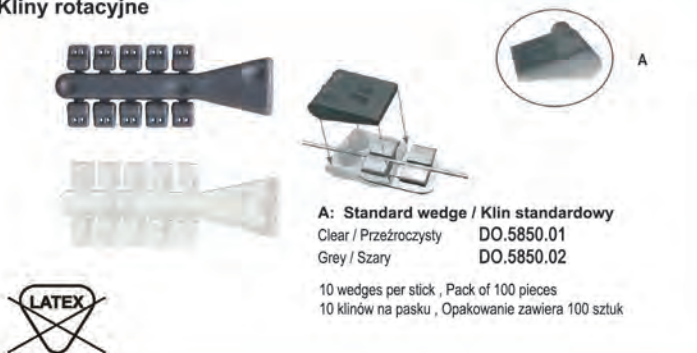

A: Standard wedge / Klin standardowy
Clear / Przezroczysty DO.5850.01
Grey / Szary DO.5850.02

10 wedges per stick, Pack of 100 pieces
10 klinów na pasku, Opakowanie zawiera 100 sztuk



Elastomeric ligatures and chains organizers
Stojaki na ligatury elastyczne i łańcuszki



DO.5980.01

DO.5980.02

DO.5982.01

Rotation wedges
Kliny rotacyjne



Pack of 100 pieces
Opakowanie zawiera 100 sztuk

Clear / Przezroczysty DO.5853.01
Grey / Szary DO.5853.02

Radiopaque posterior separators
Separatory Radiopaque, posterior

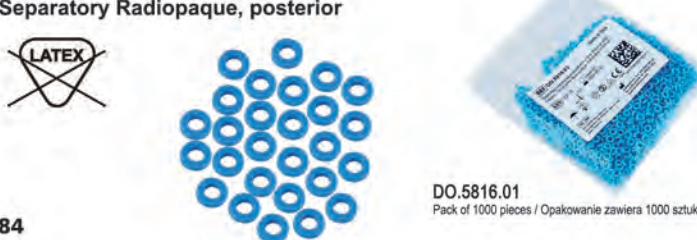

DO.5816.01
Pack of 1000 pieces / Opakowanie zawiera 1000 sztuk

Elastomeric ligature placement gun
Pistolet do zakładania ligatur elastycznych



DO.5980.00

Creatures of the Sky

Latex free Uno-intraoral elastics
Gumki / Uno-Wyciągi elastyczne bez lateksu



Box of 20 packs (100 elastics per pack) 2000 pieces
Paczka 20 torebek (100 wyciągów w torebce) 2000 sztuk

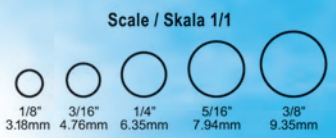

Force level / Siła wyciągu
 Light Force / Siła wyciągu lekka 2.5 oz. = 71gm
 Medium Force / Siła wyciągu średnia 3.5 oz. = 100gm
 Heavy Force / Siła wyciągu duża 4.5 oz. = 130gm
 X-Heavy Force / Siła wyciągu bardzo duża 6.5 oz. = 180gm

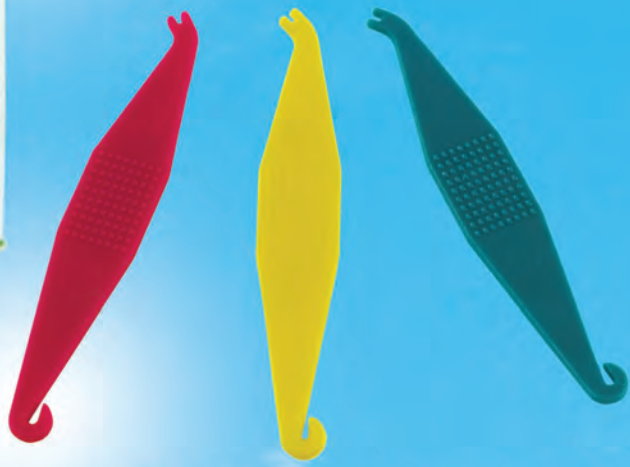

Free / Gratis
 20 x Elastic directors
 20 x Nakładaczy do wyciągów elastycznych



Latex free clear elastics / Przezroczyste wyciągi elastyczne				
	2.5oz Light / 2.5oz Lekka	3.5oz. Medium / 3.5oz Średnia	4.5oz. Heavy / 4.5oz Duża	6.5oz. X-Heavy / 6.5oz Bardzo duża
1/8" (3.2mm)	DO.5960.32	DO.5961.32	DO.5962.32	DO.5963.32
3/16" (4.8mm)	DO.5960.48	DO.5961.48	DO.5962.48	DO.5963.48
1/4" (6.4mm)	DO.5960.64	DO.5961.64	DO.5962.64	DO.5963.64
5/16" (7.9mm)	DO.5960.79	DO.5961.79	DO.5962.79	DO.5963.79
3/8" (9.5mm)	DO.5960.95	DO.5961.95	DO.5962.95	DO.5963.95

Creatures of the Sky

Latex free intraoral elastics
Gumki / Wyciągi elastyczne bez lateksu
Made in USA



Box of 20 packs (100 elastics per pack) 2000 pieces
Paczka 20 torebek (100 wyciągów w torebce) 2000 sztuk

Scale / Skala 1/1

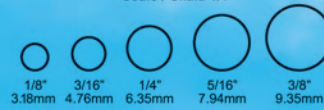

Force level / Siła wyciągu

Light Force / Siła wyciągu lekka	2.5 oz. = 71gm
Medium Force / Siła wyciągu średnia	4.5 oz. = 125gm
Heavy Force / Siła wyciągu duża	6.5 oz. = 180gm



Free / Gratis

20 x Elastic directors
20 x Nakładaczy do wyciągów elastycznych

Light force level / Siła wyciągu lekka 2.5 oz. (71 gm)



Hummingbird / koliber
1/8" (3.18 mm)



Canary / kanarek
3/16" (4.76 mm)



Finch / zięba
1/4" (6.35 mm)



Starling / szpak
5/16" (7.94 mm)



Cuckoo / kukułka
3/8" (9.35 mm)

Medium force level / Siła wyciągu średnia 4.5 oz. (125 gm)



Love birds / papużki nierozłączki
1/8" (3.18 mm)



Parakeet / papuška
3/16" (4.76 mm)



Parrot / papuga
1/4" (6.35 mm)



Cockatoos / kakadu
5/16" (7.94 mm)



Macaw / ara
3/8" (9.35 mm)

Heavy force level / Siła wyciągu duża 6.5 oz. (180 gm)



Harrier / błotniak
1/8" (3.18 mm)



Kestrel / pustułka
3/16" (4.76 mm)



Falcon / sokół
1/4" (6.35 mm)



Hawk / jastrząb
5/16" (7.94 mm)



Eagle / orzeł
3/8" (9.35 mm)

Creatures of the Sky

Latex free intraoral elastics
Gumki / Wyciągi elastyczne bez lateksu
Made in USA



Latex free clear elastics / Przeźrocyste wyciągi elastyczne			
	2.5oz Light / 2.5oz Lekka	4.5oz. Medium / 4.5oz Średnia	6.5oz. Heavy / 6.5oz Duża
1/8" (3.2mm)	DO.5950.32	DO.5952.32	DO.5953.32
3/16" (4.8mm)	DO.5950.48	DO.5952.48	DO.5953.48
1/4" (6.4mm)	DO.5950.64	DO.5952.64	DO.5953.64
5/16" (7.9mm)	DO.5950.79	DO.5952.79	DO.5953.79
3/8" (9.5mm)	DO.5950.95	DO.5952.95	DO.5953.95



Latex free neon colors / Kolorowe wyciągi elastyczne			
	2.5oz Light / 2.5oz Lekka	4.5oz. Medium / 4.5oz Średnia	6.5oz. Heavy / 6.5oz Duża
1/8" (3.2mm)	DO.5956.32	DO.5958.32	DO.5959.32
3/16" (4.8mm)	DO.5956.48	DO.5958.48	DO.5959.48
1/4" (6.4mm)	DO.5956.64	DO.5958.64	DO.5959.64
5/16" (7.9mm)	DO.5956.79	DO.5958.79	DO.5959.79
3/8" (9.5mm)	DO.5956.95	DO.5958.95	DO.5959.95

Elastic directors / Nakładacze do wyciągów elastycznych

Elastic directors make placing and removing elastics easy for patients

Pack of 50 pieces / Opak. 50 szt.

Nakładacze do wyciągów elastycznych ułatwiają pacjentowi ich nakładanie i usuwanie.

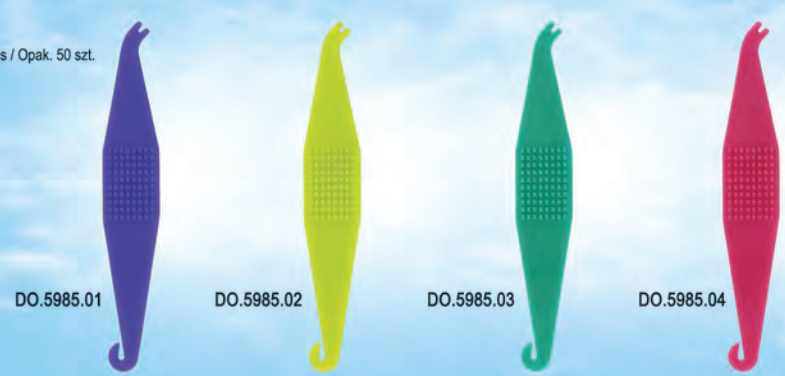



alpha-dent®
One-Step Adhesive syringe
Klej One-Step w strzykawce



DT.301-0104-001

3.5 g syringe / strzykawka 3,5g

Individual products: No-Mix or Light Cure adhesive syringe, Sealant resin, Enamel catalyst primer can be supplied on special order only.
Pojedyncze produkty tj.: klej w strzykawce światłoutwardzalny lub chemoutwardzalny i aktywatory są dostępne na specjalne zamówienie.

alpha-dent®
Enamel catalyst primer
Aktywator



DT.209-0101-001

Enamel catalyst primer 12ml / Aktywator 12ml

alpha-dent®

LIGHT CURE ORTHODONTIC ADHESIVE
ORTODONTYCZNY KLEJ DO ZAMKÓW
ŚWIATŁOUTWARDZALNY

Alpha-Dent® Light Cure Bracket Adhesive is a Paste Adhesive system formulated to bond to metal, ceramic and plastic brackets. The unique filler combination used in the paste produces an ideal bond and a smooth tacky consistency minimizing bracket flotation. By using light cure adhesive technology we have eliminated working time constraints.

Klej światłoutwardzalny jest odpowiedni do zamków metalowych, ceramicznych i plastikowych. Wyjątkowy materiał klejący gwarantuje lepkość, dzięki której zamki nie przesuwają się. Korzystanie z technologii utwardzenia kleju światłem oszczędza czas pracy lekarza.



DT.303-0002-001

Contents / Zestaw zawiera:

- 1 x 3.5gm Syringes
- 1 x Strzykawki po 3,5g
- 1 x 3ml Sealant Resin
- 1 x 3ml Aktywator
- 1 x 7ml Green Gel Etchant
- 1 x 7ml Wytrawiacz
- 50 x Mixing Pads
- 50 x Bloczków
- 2 x Mixing spatulae
- 2 x Łopatkki do mieszania
- 25 x Brushes
- 25 x Pędzelków krótkich



DT.303-0003-001

Contents / Zestaw zawiera:

- 4 x 3.5gm Syringes
- 4 x Strzykawki po 3,5g
- 2 x 3ml Sealant Resin
- 2 x 3ml Aktywator
- 1 x 7ml Green Gel Etchant
- 1 x 7ml Wytrawiacz
- 50 x Mixing Pads
- 50 x Bloczków
- 2 x Mixing spatulae
- 2 x Łopatkki do mieszania
- 50 x Brushes
- 50 x Pędzelków krótkich



alpha-dent[®]

**ONE STEP BRACKET ADHESIVE
ONE STEP ORTODONTYCZNY KLEJ DO
ZAMKÓW CHEMOUTWARDZALNY**



**DENTAL
TECHNOLOGIES**
improving smiles around the world

Alpha-Dent® One-Step Bracket Adhesive is a Paste-Primer system formulated to bond to metal, ceramic and plastic brackets. The unique filler and primer combination used produces an ideal bond and a smooth tacky viscosity minimizing bracket flotation.

Klej chemoutwardzalny One-Step jest odpowiedni do zamków metalowych, ceramicznych i plastikowych. Wyjątkowe połączenie materiału klejącego i aktywatora gwarantuje lepkość, dzięki której zamki nie przesuwiają się.



DT.301-0003-001

Contents / Zestaw zawiera:

- 4 x 3.5gm Syringes
- 4 x Strzykawkę po 3,5g
- 1 x 12ml Enamel Catalyst Primer
- 1 x 12ml Aktywator
- 1 x 7g Green Gel Etchant
- 1 x 7g Wytrawiacz
- 50 x Mixing Pads
- 50 x Bloczków
- 2 x Brush Holder
- 1 x Uchwyt do pędzelków
- 50 x Brushes
- 50 x Pędzelków krótkich



alpha-dent[®]

**ONE STEP BRACKET ADHESIVE
ONE STEP ORTODONTYCZNY KLEJ DO
ZAMKÓW CHEMOUTWARDZALNY**

Starter kit / Zestaw startowy

DT.301-0008-001

Contents / Zestaw zawiera:

- 1 x 3.5gm Syringe
- 1 x Strzykawkę po 3,5g
- 1 x 5ml Enamel Catalyst Primer
- 1 x 5ml Aktywator
- 1 x 3g Green Gel Etchant
- 1 x 3g Wytrawiacz
- 50 x Mixing Pads
- 50 x Bloczków
- 2 x Mixing spatulae
- 2 x Łopatkę do mieszania
- 25 x Brushes
- 25 x Pędzelków krótkich



alpha-dent®
Light Cure adhesive syringe
Klej światłoutwardzalny w strzykawce



alpha-dent®
Sealant resin
Aktywator



DT.303-0202-001
3.5 g syringe / 3,5 g strzykawka

Individual products: No-Mix or Light Cure adhesive syringe, Sealant resin, Enamel catalyst primer can be supplied on special order only. Pojedyncze produkty tj.: klej w strzykawce światłoutwardzalny lub chemoutwardzalny i aktywatory są dostępne na specjalne zamówienie.

DT.208-0101-001
Sealant resin 7ml / Aktywator 7ml

alpha-dent®
Light Cure blue band cement syringes
Cement do pierścieni światłoutwardzalny Blue

Alpha-Dent® Light Cure Band Adhesive is a single paste resin-based, fluoride containing band adhesive. The single paste adhesive requires no mixing; resulting in reducing adhesive waste, consistent adhesive performance and now working time constraints. Alpha-Dent® Light Cure Band Adhesives distinctive blue color allows you to easily see the adhesive during banding, making clean up easy. When used with a high performance curing light, cure time is 20 seconds.

Cement do pierścieni jest pastą na bazie żywicy, zawierającą fluor. Nie wymaga mieszania, oszczędza czas, redukuje marnowanie materiału. Niebieski kolor wskazuje na ewentualny nadmiar kleju przed utwardzeniem oraz ułatwia zlokalizowanie resztek kleju po usunięciu pierścienia. Należy naświetlać lampą 20 sekund.



DT.320-0000-001
Contents / Zestaw zawiera:
6 x 5gm Syringes
6 x Strzykawek po 5 g

alpha-dent®
Light Cure blue band cement syringes
Cement do pierścieni światłoutwardzalny
Blue w strzykawce



DT-320-0101-001
5 gm Syringes / 5 g Strzykawka

Adhesive removers carbide burs
Wiertło z węgla spiekane

Each / Sztuka

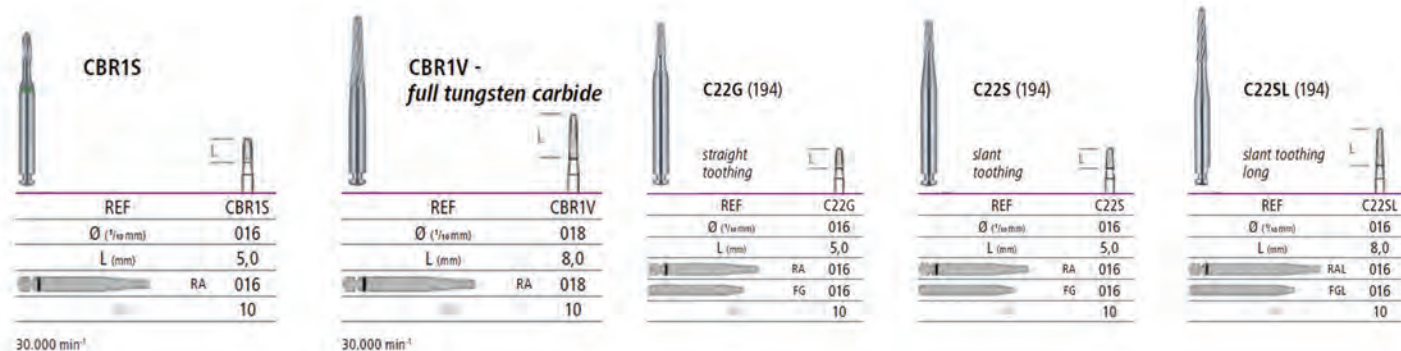

Adhesive removers latex free
Gumki polerskie do usuwania kleju / cementu bez latexu

Latex free polymer polishers with blend of soft glass granules for the removal of orthodontic cements without scratching or scraping the enamel

max. 20'000 rpm



Code / Kod	S191	S192	S193
L mm	6,5	10,5	8,0
Ø mm	3,0	5,0	6,0

Adhesive remover sets
Zestawy gumek do usuwania kleju/cementu

max. 20'000 rpm



SET1017
Adhesive remover set I - 9 pieces
Zestaw I - 9 sztuk.



Contents / Zawiera	3 pcs / szt.	3 pcs / szt.	3 pcs / szt.
L mm	6,5	10,5	8,0
Ø mm	3,0	5,0	6,0



Contents / Zawiera	3 pcs / szt.	3 pcs / szt.	3 pcs / szt.	3 pcs / szt.
L mm	6,5	10,5	8,0	4,3
Ø mm	3,0	5,0	6,0	1,6



SET1018
Adhesive remover set II - 12 pieces
Zestaw II - 12 sztuk.

Prophylaxis pastes fluoride free 250g
Pasty polerskie bez fluoru 250g



Jar / Słoiczek
250 g.

PP010/0051 Medium Mint / Standardowa miętowa
PP010/0052 Coarse Orange / Ostra pomarańczowa

Prophy paste cup
Pojemnik do pasty polerskiej



DZ.990.010

Prophylaxis pastes fluoride free, mint flavoured
Pasty polerskie bez fluoru, miętowe



Jar / Słoiczek
50 g.

PAS001 Medium / Średnioziarnista

Made of 100% natural ingredients.
Zawierają 100% naturalnych składników.

Etching gel / Wytrawiacze

36 % phosphoric acid etching gel
Wytrawiacz kwaso-fosforowy 36%



DR.2000.01 2ml
DR.2000.02 10ml
DR.2000.03 50ml

alpha-dent®

Orthodontic Paste
Pasta polerska bez fluoru



DENTAL TECHNOLOGIES
Improving smiles around the world

Alpha-Pro® Orthodontic Paste is a splatter-free formula that rinses easily and completely. Alpha-Pro® Orthodontic Paste comes without added color pigments, flavor and fluoride for patients who may be allergic to additives. The paste is available in medium grit and is recommended for normal cleaning, polishing, and plaque removal. The medium grit paste is ideal for use prior to composite bonding, sealants, and orthodontic bracket applications



Made in USA



DT.560-1301-002
Pack of 200 single dose / Opak. 200 szt.
2 gm dispensers / 2 gm kapsułki

Bond brushes micro
Pędzelki do bondingu mikro

Made in Germany

Pack of 100 pieces
Opak, 100 szt.



DZ.8610.01



DZ.8610.02



DZ.8610.03



DZ.8610.04

Bond brushes standerd
Pędzelki do bondingu standardowe

Pack of 100 pieces
Opak, 100 szt.



DZ.8611.01



DZ.8611.02

Syringes and applicator organizer
Stojak na strzykawkę i mikro aplikatory



DR.9999.00



Prophy brushes RA / Szczoteczki do polerowania na kątnicę

For cleaning and polishing of natural teeth, gold, amalgam fillings and removing plaque stains. Use with prophylaxis paste.

Czyszcza i polerują zęby, złoto, wypełnienia amalgamatowe oraz redukują płytkę nazębną. Szczoteczki do profilaktyki z zastosowaniem pasty polerskiej.

max. 10'000 rpm



Code / Kod P001 P002 P003 P004 P005

White nylon / Nylonowe białe



Code / Kod P006
White nylon / Nylonowe białe



White nylon / Nylonowe białe
Ø 5 mm



Code / Kod DH.5015.01 DH.5015.02

Pack / Opak 50 pieces / szt. 100 pieces / szt.

SMART Color coded prophy cups latex free RA Gumki do polerowania bez lateksu na kątnicę

max. 10'000 rpm

Use with prophylaxis paste / Używać z pastą polerską



Code / Kod PSRA001 PSRA002 PSRA003 PRA001 PRA002 PRA003

Pack of 100 pieces
Opak. 100 szt.

1.500 - 3.000
r.p.m

Regular / Standardowe



white

Regular / Standardowe



Assorted

Code / Kod DH.5009.01

DH.5009.00

Disposable prophy cups and brushes Jednorazowe gumki i szczoteczki

Pack of 100 pieces / Opak. 100 szt.

1.500 - 3.000
r.p.m



DH.5010.02
Soft / Miękka



DH.5010.01
Regular / Standardowe



DH.5010.04
Pointed brush
Szczoteczka stożkowa



DH.5010.03
Standard brush
Szczoteczka standardowa

Bonding tray with sliding cover Etui do zamków



DO.1991.10
DO.1991.20
DO.1991.30

Disposable bonding trays Podstawki do zamków



with mixing wells
z miejscem do mieszania
DO.1990.11

without mixing wells
bez miejsca do mieszania
DO.1990.10
DO.1990.20

Disposable bonding trays organizer Stojak na podstawki do zamków



DO.1990.00

Safety release modules with stainless steel clamps / Moduły bezpieczeństwa ze stalową klamrą

Pair / Para



Force / Siła	Dark Blue Granatowy	Light Blue Jasnoniebieski	Green Zielony	Purple Purpurowy	Red Czerwony
600 gm	DO.6121.01	DO.6121.02	DO.6121.04	DO.6121.05	DO.6121.06
750 gm	DO.6122.01	DO.6122.02	DO.6122.04	DO.6122.05	DO.6122.06

High pull head caps / Wyciągi czaszkowe

Each / Sztuka

 DO.6140.01 Small / Male
 DO.6140.02 Medium / Średnie
 DO.6140.03 Large / Duże

Cervical neck pads / Wyciągi karkowe

 DO.6130.01
 Blue / Niebieskie
 Pack of 5 pieces / Opak. 5 szt.

Headgear bags / Etui na wyciągi czaszkowe

224 x 120 mm

 DO.6145.00
 Assorted colors / Różne kolory
 Pack of 5 pieces / Opak. 5 szt.

Each / Sztuka

 DO.6145.01 Blue / Male
 DO.6145.02 Red / Średnie
 DO.6145.03 Yellow / Żółty
 DO.6145.04 Grey / Szary
 DO.6145.05 White / Biały

Cervical neck pads / Wyciągi karkowe

 With safety modules
 Z modułów bezpieczeństwa

DO.6131.01

DO.6131.00

Extraoral elastics / Wyciągi zewnętrzne

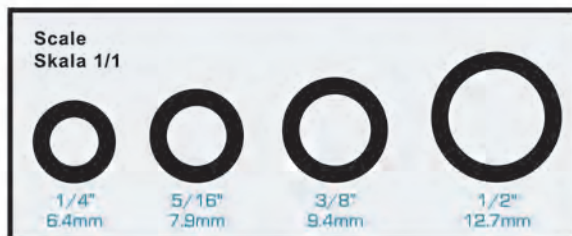
 Pack of 1000 pieces
 Opak. 1000 szt.

Extraoral elastics			
Force / Siła	8.0 oz	14.0 oz	16.0 oz
1/4" (6.4mm)	DO.6170.01	DO.6171.01	DO.6172.01
5/16" (7.9mm)	DO.6170.02	DO.6171.02	DO.6172.02
3/8" (9.4mm)	DO.6170.03	DO.6171.03	DO.6172.03
1/2" (12.7mm)	DO.6170.04	DO.6171.04	DO.6172.04



Facebows with loops / Łuki twarzowe z pętlą



Outer bow is available in 3 lengths
Zewnętrzny łuk dostępny w 3 długościach

#	Intermolar parameter Rozpiętość	Short Krotki	Medium Sredni	Long Dlugi
1	83 mm	DO.6107.01	DO.6108.01	DO.6109.01
2	90 mm	DO.6107.02	DO.6108.02	DO.6109.02
3	97 mm	DO.6107.03	DO.6108.03	DO.6109.03
4	104 mm	DO.6107.04	DO.6108.04	DO.6109.04
5	111 mm	DO.6107.05	DO.6108.05	DO.6109.05

Intermolar parameter from loop to loop in millimeter
Rozpiętość od pętli do pętli w mm

Universal colored facebows / Łuki twarzowe uniwersalne kolorowe
Standard - Form

Outer bow / Łuk zewnętrzny Ø .072"
Inner bow / Łuk wewnętrzny Ø .045"

- DO.6105.01 White / Biały
- DO.6105.02 Blue / Niebieski
- DO.6105.03 Purple / Purpurowy
- DO.6105.04 Yellow / Żółty
- DO.6105.05 Black / Czarny
- DO.6105.06 Orange / Pomarańczowy
- DO.6105.07 Dark Green / Ciemna zieleń
- DO.6105.08 Lime Green / Jasna zieleń



Universal facebows / Łuki twarzowe uniwersalne

Outer bow / Łuk zewnętrzny Ø .072"
Inner bow / Łuk wewnętrzny Ø .045"



Full-Form DO.6103.01
Standard-Form DO.6104.01

Plain facebows / Łuki twarzowe

Outer bow Ø .072"
Łuk zewnętrzny Ø .072"



Inner bow Ø / Łuk wewnętrzny Ø
.045" DO.6102.01

Cervical Neckpads / IOS Comfort opaski karkowe



DO.6132.01



DO.6132.04



DO.6132.02



DO.6132.05



DO.6132.03

Each / Sztuka



Made in USA

Lip Bumpers / Peloty wargowe

Wire Ø .045" / Drut Ø .045"



Color Kolor	Standard-Form		Full-Form	
	Without hooks Bez haczyków	With hooks Z haczykami	Without hooks Bez haczyków	With hooks Z haczykami
Blue / Niebieskie	DO.6115.01	DO.6116.01	DO.6117.01	DO.6118.01
Pink / Różowe	DO.6115.02	DO.6116.02	DO.6117.02	DO.6118.02
Red / Czerwone	DO.6115.03	DO.6116.03	DO.6117.03	DO.6118.03
White / Białe	DO.6115.04	DO.6116.04	DO.6117.04	DO.6118.04
Yellow / Żółte	DO.6115.05	DO.6116.05	DO.6117.05	DO.6118.05

High Pull Head Caps / Czepiec do procy bródkowej

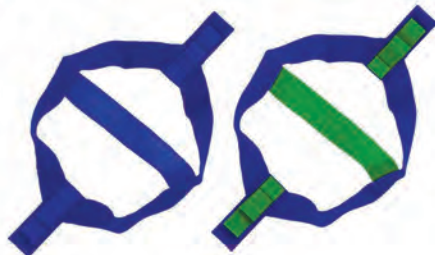

Color Kolor	
Red / Czerwone	DO.6140.04
Blue / Niebieski	DO.6140.06
Green / Zielony	DO.6140.05

Chin cups / Proce bródkowe

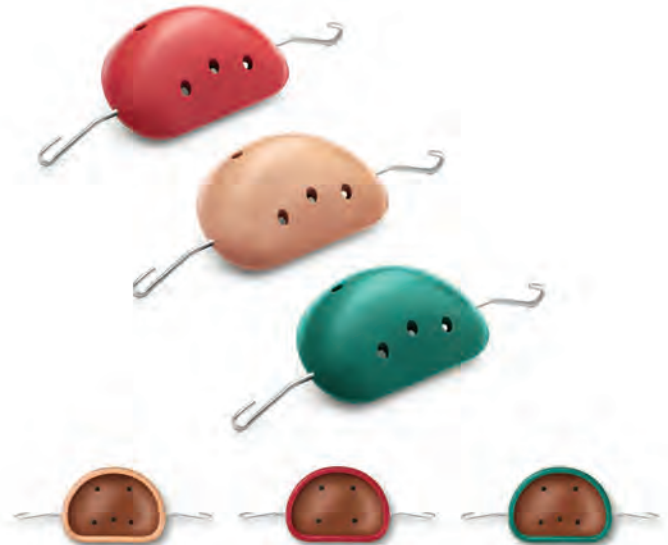

Color Kolor	For child Dla dzieci	For adult Dla dorosłych
Red / Czerwone	DO.6141.01	DO.6142.01
Green / Zielony	DO.6141.02	DO.6142.02
Skin / Cielista	DO.6141.03	DO.6142.03



Face masks / Maski twarzowe

COMFI-MAX

Reverse pull face masks Delaire / Maski twarzowe Delaire



PRODOTTO
100% ITALIANO

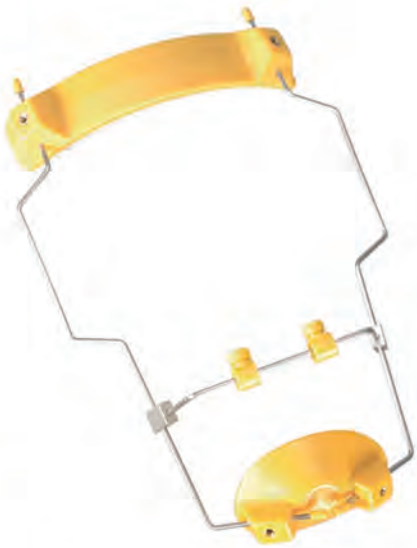
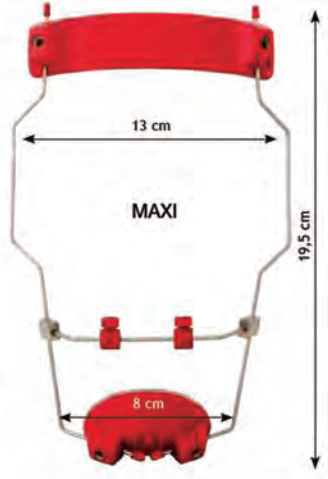
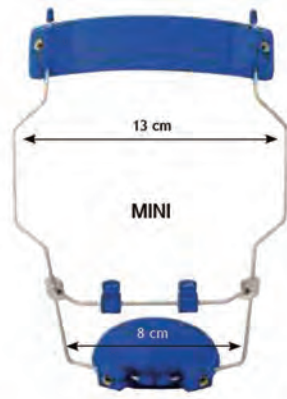

Blue
Niebieska

Green
Zielona

Red
Czerwona

White
Biala

Yellow
Zolta

Mini	DO.6150.01	DO.6150.02	DO.6150.03	DO.6150.04	DO.6150.05
Maxi	DO.6151.01	DO.6151.02	DO.6151.03	DO.6151.04	DO.6151.05



Face masks / Maski twarzowe

COMFI-MAX

Fully-Adjustable face masks
Regulowane maski twarzowe



Blue
Niebieska

Clear
Przeźroczysta

Pearl
Perłowa

Red
Czerwona

Teal
Jasnozielona

DO.6154.01

DO.6154.02

DO.6154.03

DO.6154.04

DO.6154.05

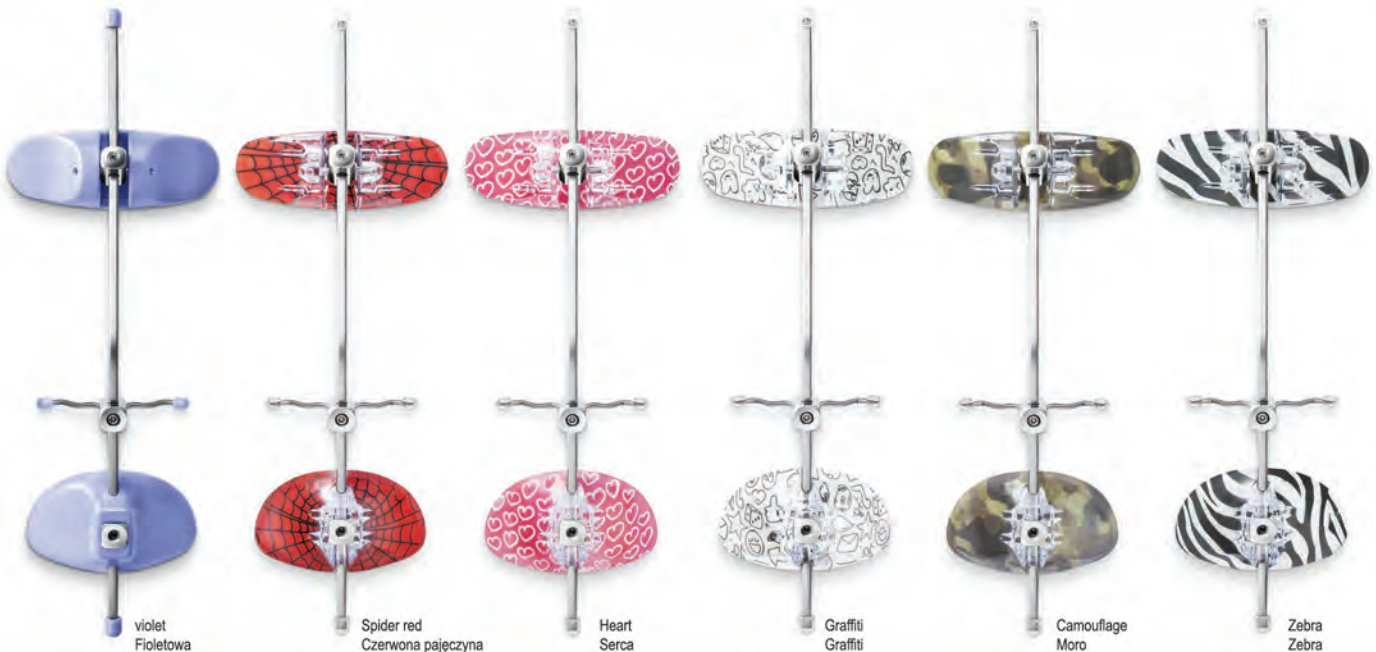

violet
Fioletowa

Spider red
Czerwona pajęczyna

Heart
Serca

Graffiti
Graffiti

Camouflage
Moro

Zebra
Zebra

DO.6154.11

DO.6154.06

DO.6154.07

DO.6154.08

DO.6154.09

DO.6154.10

Face mask bags / Etui na maski twarzowe

For face masks Delaire / Na maski twarzowe Delaire
For fully-adjustable face masks / Na maski twarzowe regulowane



DO.6159.08
Blue / Niebieskie

DO.6159.09
Green / Zielone

DO.6159.10
White / Białe

DO.6159.11
Yellow / żółte

DO.6159.12
Red / Czerwone

Bruxism splint / Szyna nagryzowa z zaczepami



- DO.6580.01 Clear Przeźroczysta
- DO.6580.02 Pink / Bubble gum Różowa / Guma do żucia

Prevents the constant grinding that leads to TMJ disorder. Can be used over braces without effecting tooth movement.

Szyna jest skutecznym sposobem leczenia objawów zaburzeń stawów skroniowo-żuchwowych (TMJ) tj. zaciskania, ścierania czy zgrzytania zębami. Odpowiednia dla pacjentów noszący aparat stały

**Soft plastic comfort covers
Ochraniacze wargowe plastikowe**



DO.6241.00
Pair / Para

**Retainer case for Invisible retainers
Pudełko na retainery Invisalign**

Each / Sztuk



DO.6323.01



DO.6323.02



**Retainer retrievers
Instrument do zdejmowania elastycznych aparatów retencyjnych**



- Each / Sztuk
- DO.6500.01 Blue / Niebieski
- DO.6500.02 Green / Zielony
- DO.6500.03 Pink / Różowy
- DO.6500.04 Orange / Pomarańczowy
- DO.6500.05 White / Biały

**Retainer seater & retainer retriever in case
Zestaw do elast. aparatów retencyjnych w pudełku**

Simple solution for properly seating aligners with imperfect fit.
Proste rozwiązanie dla dokładnego umiejscowienia aparatu retencyjnego.



- DO.6504.01  Mint / Miętowy
- DO.6504.02  Bubble gum / Guma do żucia
- DO.6504.03  Grape / Winogrono
- DO.6504.04  Unscented / Bez zapachu
- DO.6504.05  Orange / Pomarańczowy

Retainer seater 2 pieces + retainer retriever in case
2 nagryzacze + instrument

**Silicone comfort covers
Ochraniacze wargowe silikonowe**



DO.6240.00
Pair / Para

**Elasti-Bite
Therapy wafers scented / Wafel do nagryzania zapachowy**



- DO.6230.01 Cherry / Wiśnia
- DO.6230.02 Grape / Winogrono
- DO.6231.01 Bubblegum / Guma do żucia
- DO.6231.02 Mint / Mięta
- Pack of 10 pieces / Opak. 10 szt.

Relief wax organizer / Stojak na wosk



- Made from strong, high quality clear acrylic
- Removable cover slides on and off for easy dispensing and re-stocking
- Holds 100 boxes



DO.6220.00

Clear relief wax unscented box
Przeźroczysty wosk osłony bezzapachowy

For relief against irritation caused by brackets and ligature wires
Wosk przynoszący ulgę pacjentowi podczas noszenia aparatu stałego



Pack of 10 pieces / 1 opak. wosku zawiera 10 pudełeczek jednego koloru



Box color / Kolor pudełka	Clear / Przeźroczysty	Silver / Srebrny	Green / Zielony
Code / Kod	DO.6200.02	DO.6200.03	DO.6200.06



Box color / Kolor pudełka	Pink / Różowy	Orange / Pomarańczowy	White / Biały
Code / Kod	DO.6200.10	DO.6200.13	DO.6200.14

Clear relief wax scented box
Przeźroczysty wosk osłony zapachowy

For relief against irritation caused by brackets and ligature wires
Wosk przynoszący ulgę pacjentowi podczas noszenia aparatu stałego



Pack of 10 pieces / 1 opak. wosku zawiera 10 pudełeczek jednego koloru



Box color / Kolor pudełka	Blueberry / Jagoda	Bubblegum / Guma do żucia	Cherry / Wiśnia
Code / Kod	DO.6206.02	DO.6206.03	DO.6206.05



Box color / Kolor pudełka	Chocolate / Czekolada	Cinnamon / Cynamon	Coconut / Kokos
Code / Kod	DO.6206.06	DO.6206.07	DO.6206.08



Box color / Kolor pudełka	Cotton candy / Cukierek	Grape / Winogrono	Mint / Mięta
Code / Kod	DO.6206.09	DO.6206.10	DO.6206.11



Box color / Kolor pudełka	Orange / Pomarańcza	Pineapple / Ananas
Code / Kod	DO.6206.12	DO.6206.13



Clear relief wax unscented box Przeźroczysty wosk osłonowy bezzapachowy

For relief against irritation caused by brackets and ligature wires
Wosk przynoszący ulgę pacjentowi podczas noszenia aparatu stałego



Pack of 10 pieces / 1 opak. wosku zawiera 10 pudełeczek jednego koloru



Box color / Kolor pudełka	Clear / Przeźroczysty	Silver / Srebrny	Purple / Purpurowy	Blue / Niebieski
Code / Kod	DO.6204.02	DO.6204.03	DO.6204.05	DO.6204.06



Box color / Kolor pudełka	Green / Zielony	Orange / Pomarańcz	Pink / Różowy
Code / Kod	DO.6204.07	DO.6204.08	DO.6204.09

Clear relief wax scented box Przeźroczysty wosk osłonowy zapachowy

For relief against irritation caused by brackets and ligature wires
Wosk przynoszący ulgę pacjentowi podczas noszenia aparatu stałego



Pack of 10 pieces / 1 opak. wosku zawiera 10 pudełeczek jednego koloru



Scent / Zapach	Apple / Jabłko	Blueberry / Jagoda	Bubblegum / Guma do żucia	Cherry / Wiśnia
Code / Kod	DO.6205.01	DO.6205.02	DO.6205.03	DO.6205.05



Scent / Zapach	Chocolate / Czekolada	Cinnamon / Cynamon	Coconut / Kokos	Cotton candy / Cukierek
Code / Kod	DO.6205.06	DO.6205.07	DO.6205.08	DO.6205.09



Scent / Zapach	Grape / Winogrono	Mint / Mięta	Orange / Pomarańcza	Pineapple / Ananas
Code / Kod	DO.6205.10	DO.6205.11	DO.6205.12	DO.6205.13



Scent / Zapach	Tutti-Frutti / Tutti-Frutti
Code / Kod	DO.6205.16



Brace Gard relief silicone
Brace Gard Silikon osłonowy



1. It is made of silicone, not wax. Silicone does not break down and crumble as quickly as regular dental wax, so it lasts longer in your mouth.
2. You can re-use it within the same day. For example, you can re-apply the same strip after brushing your teeth.
3. Unlike dental wax, to use Brace Gard your brackets must be totally dry for the product to adhere properly. This sometimes takes some trial and error. Most people love the product once they get the hang of applying it. Each container includes a built-in mirror to help you apply the product.



DO.6211.00
Assorted / Asortyment
Pack of 10 pieces / Opak. 10 szt.

Retainer cases classic mini
Pudełka classic mini na retainery

Size / Rozmiar	
22 mm	Deep / Głębokość
72 mm	Wide / Szerokość
65 mm	Long / Długość



DO.6321.00
Assorted / Asortyment
Pack of 12 pieces / Opak. 12 szt.

DO.6322.00
Assorted / Asortyment
Pack of 15 pieces / Opak. 15 szt.

Euro retainer cases Maxi
Pudełka ortodontyczne Euro Maxi



DO.6316.00
Assorted colors / Asortyment

Pack of 10 pieces
Opak. 10 szt.

Euro retainer cases Maxi
Pudełka ortodontyczne Euro Maxi

Pack of 10 pieces / Opak. 10 szt.

Size / Rozmiar

38 mm	Deep / Głębokość
76 mm	Wide / Szerokość
64 mm	Long / Długość



DO.6306.01
Sparkle aqua
Metallic morski



DO.6306.02
Sparkle black
Metallic czarny

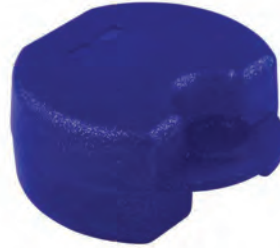

DO.6306.03
Sparkle blue
Metallic niebieski



DO.6306.04
Sparkle green
Metallic zielony



DO.6306.05
Sparkle purple
Metallic purpurowy



DO.6306.06
Sparkle red
Metallic czerwony



DO.6306.08
Yellow
Żółty



DO.6306.11
Sparkle cool mint
Metallic miętowy



DO.6306.12
Sparkle plum
Metallic śliwkowy



DO.6307.01
Tropical Blue
Fluorescencyjny niebieski



DO.6307.02
Tropical green
Fluorescencyjny zielony



DO.6307.03
Tropical orange
Fluorescencyjny pomarańczowy



DO.6307.04
Tropical pink
Fluorescencyjny różowy



DO.6308.01
Splash
W kleksy



DO.6308.02
Splash kiwi
Kiwi w kleksy



DO.6308.03
Splash ocean
Ocean w kleksy



DO.6308.04
Splash tangerine
Mandarynka w kleksy



DO.6309.01
Glow in the dark
Świecąca w ciemności

DO.6306.00

Assorted colours / Asortyment

- DO.6306.01 Sparkle aqua / Metallic morski
- DO.6306.02 Sparkle black / Metallic czarny
- DO.6306.03 Sparkle blue / Metallic niebieski
- DO.6306.04 Sparkle green / Metallic zielony
- DO.6306.05 Sparkle purple / Metallic purpurowy
- DO.6306.06 Sparkle red / Metallic czerwony
- DO.6307.01 Tropical Blue / Fluorescencyjny niebieski
- DO.6307.02 Tropical green / Fluorescencyjny zielony
- DO.6307.03 Tropical orange / Fluorescencyjny pomarańczowy
- DO.6307.04 Tropical pink / Fluorescencyjny różowy

Pack of 10 pieces / Opak. 10 szt.



Euro retainer cases Midi
Pudełka ortodontyczne Euro Midi



DO.6300.02
Sparkle black
Metallic czarny



DO.6300.03
Sparkle green
Metallic zielony



DO.6300.05
Sparkle purple
Metallic purpurowy



DO.6300.06
Sparkle red
Metallic czerwony



DO.6301.01
Tropical Blue
Fluorescencyjny niebieski



DO.6301.02
Tropical green
Fluorescencyjny zielony



DO.6301.03
Tropical orange
Fluorescencyjny pomarańczowy



DO.6301.04
Tropical pink
Fluorescencyjny różowy



DO.6303.01
Glow in the dark
Świecące w ciemności

- DO.6300.00**
Assorted colours / Asortyment
- DO.6300.02 Sparkle black / Metallic czarny
 - DO.6300.03 Sparkle green / Metallic zielony
 - DO.6300.05 Sparkle purple / Metallic purpurowy
 - DO.6300.06 Sparkle red / Metallic czerwony
 - DO.6301.01 Tropical Blue / Fluorescencyjny niebieski
 - DO.6301.02 Tropical green / Fluorescencyjny zielony
 - DO.6301.03 Tropical orange / Fluorescencyjny pomarańczowy
 - DO.6301.04 Tropical pink / Fluorescencyjny różowy
 - DO.6302.01 Splash / W kleksy
 - DO.6303.01 Glow in the dark / Świecące w ciemności

Pack of 10 pieces / Opak. 10 szt.

Size / Rozmiar

31 mm	Deep / Głębokość
76 mm	Wide / Szerokość
64 mm	Long / Długość



Slim-Line retainer cases
Slim-Line Pudełka ortodontyczne



DO.6311.01
Sparkle Black / Metallic czarny



DO.6311.04
Sparkle Green / Metallic Zielony



DO.6311.05
Sparkle Purple / Metallic Purpurowy



DO.6311.06
Sparkle Red / Metallic Czerwony



DO.6312.01
Tropical Blue / Fluorescencyjny niebieski



DO.6312.02
Tropical Green / Fluorescencyjny Zielony



DO.6312.03
Tropical Orange / Fluorescencyjny pomarańczowy



DO.6312.04
Tropical Pink / Fluorescencyjny różowy



DO.6311.13
Sparkle Cool Mint / Metallic miętowy

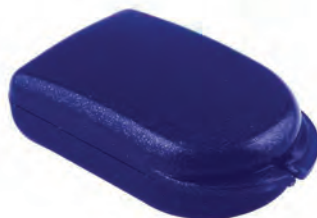

DO.6311.14
Sparkle Plum / Metallic śliwkowy



DO.6311.00
Assorted / Asortyment
Pack of 10 pieces / Opak. 10 szt.

Pack of 10 pieces / Opak. 10 szt.

Size / Rozmiar

35 mm	Deep / Głębokość
50 mm	Wide / Szerokość
85 mm	Long / Długość

Retainer cases with mirror / Pudełko protetyczne z lusterkiem

Size / Rozmiar	
28 mm	Deep / Głębokość
82 mm	Wide / Szerokość
85 mm	Long / Długość



DO.6351.00
Pack of 10 pieces / Opak. 10 szt.

Retainer cases classic / Pudełko protetyczne Classic



Pack of 10 pieces / Opak. 10 szt.

Size / Rozmiar	
32 mm	Deep / Głębokość
70 mm	Wide / Szerokość
60 mm	Long / Długość



Each / Sztuka

DO.6350.00M
Mirror for classic retainer case
Lusterko do pudełka protetycznego

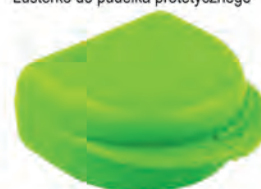

Color / Kolor	Black / Czarne	Blue Dark / Ciemnoniebieskie	Blue Light / Jasnoniebieskie	Green Fluorescent / Fluorescencyjna zieleń
Midi	DO.6320.01	DO.6320.02	DO.6320.03	DO.6320.04
Midi with mirror z lusterkiem	DO.6350.01	DO.6350.02	DO.6350.03	DO.6350.04



Color / Kolor	Orange / Pomarańczowe	Pink Hot / Ostry róż	Purple / Purpurowe	Red / Czerwone
Midi	DO.6320.05	DO.6320.06	DO.6320.07	DO.6320.08
Midi with mirror z lusterkiem	DO.6350.05	DO.6350.06	DO.6350.07	DO.6350.08



Color / Kolor	Violet / Fioletowe	Yellow / Żółte	Assorted / Mix kolorów
Midi	DO.6320.10	DO.6320.11	DO.6320.00
Midi with mirror z lusterkiem	DO.6350.10	DO.6350.11	DO.6350.00

Orthodontic retainer or bleaching tray cases / Pudełka ortodontyczne na retainery i szyny wybielające



Pack of 10 pieces
Opak. 10 szt.

DO.6314.00
Assorted colors / Asortyment



Ultima Guard
Ultimate mouth guard
Ochraniacz sportowy do warg



	Without strap Bez paska	With strap Z paskiem
Color / Kolory	Code / Kod	Code / Kod
Blue / Niebieski	DO.6250.02	DO.6251.02
Clear / Przezroczysty	DO.6250.03	DO.6251.03
Green / Zielony	DO.6250.04	DO.6251.04
Silver / Srebrny	DO.6250.06	DO.6251.06
Yellow / Żółty	DO.6250.07	DO.6251.07

- The first truly breathable mouth guard
 - Protect lips, cheeks and gums from contact with braces while playing sports
 - Three breathing vents to maximise airflow
 - Tongue guard protects the tongue from protruding through the vents
 - Comfortable and easy to wear
 - Can be heated and customised for each patient
- Pierwszy nieutrudniający oddychania ochraniacz do warg
 - Ochronia wargi, policzki i dziąsła przed kontaktem z zamkami podczas uprawiania sportu.
 - Trzy otwory ułatwiające przepływ powietrza.
 - Skutecznie chronią język
 - Wygodny i łatwy w użyciu.
 - Pod wpływem ciepła dopasowuje się do jamy ustnej pacjenta

Functional vestibular appliance- Schönherr's plates / Płytki przedsionkowe Schönherra



DO.8090.01
Small – under 3 years
Mała – dla dzieci poniżej 3 lat



DO.8090.02
Medium – 3 to 5 years
Średnia – dla dzieci 3-5 lat



DO.8090.03
Large – 5 to 7 years
Duża – dla dzieci 5-7 lat

Intraoral & extraoral elastic band case / Pudełeczka na wyciągi wewnętrzne lub zewnętrzne z nakładaczem

Pack of 10 pieces / Opak. 10 szt.



DO.5986.00
Assorted / Asortyment





ICON

Interdental brushes standard / Szczoteczki do przestrzeni międzyzębowych standard

High tensile strength, plastic coated, stainless steel wire at the core prevents the brushes from bending. Brush is also fully flexible and after bending will retain its original shape. The brush and handle are manufactured as a complete unit so there is no need to assemble. Additionally each brush has its own hygienic cap which can also be used as a handle extension (except ID114 and ID115).

Stalowy rdzeń szczoteczki bardzo wytrzymały, nie łamie się nawet po wielokrotnym zgięciu, solidnie umieszczony w ergonomicznym uchwycie. Elastyczne, nylonowe włosie szczoteczki zawsze powraca do swojego początkowego kształtu. Szczoteczki posiadają nakładkę ochronną, która może służyć jako przedłużenie uchwytu.

Pack of 8 pieces / Opak. 8 szt.



Size / Rozmiar	XXXXF	XXXF	XXF	XF	F	M	L	XL
Ø mm	1,8	2,0	2,5	3,0	3,5	5,0	6,0	9,0
L mm	12,0	12,5	12,0	13,0	13,0	13,0	16,0	19,0
Color / Kolor	Pink Różowe	Orange Pomarańczowe	Red Czerwone	Blue Niebieskie	Yellow Żółte	Green Zielone	Purple Purpurowe	Grey Szare
Code / Kod	ID121	ID120	ID119	ID118	ID117	ID116	ID115	ID114

Tandex Flexi interdental brush / Szczoteczki do przestrzeni międzyzębowych

Each / Sztuka



Size / Rozmiar	X-Micro	Micro fine	Ultra fine	Super fine	X-fine	Fine	X-fine tapere / stożkowe	Stożkowe	Medium
Ø mm	2,5	2,5	2,5	3,0	3,0	3,5	3 - 5	3 - 6	8,0
Wire thickness / Grubość drutu	0,35	0,40	0,45	0,50	0,60	0,70	0,80	1,00	1,20
Color / Kolor	Turquoise Morskie	Coral Różowe	Tangerine Pomarańczowa	Ruby Czerwona	Aqua Niebieska	Lemon Żółte	Lilac Lilowe	Lime Zielone	Violet Ciemnofioletowe
Code / Kod	TF-ID200	TF-ID201	TF-ID202	TF-ID203	TF-ID204	TF-ID205	TF-ID206	TF-ID207	TF-ID208

ORAL-B Super Floss / Nić ORAL-B Super Floss



- 1 Ideal for braces, bridges and wide spaces
- 2 Stiffened end to floss under appliances
- 3 Spongy-floss to clean around appliances and in wide spaces
- 4 Regular floss to remove plaque under gumline
- 5 Pre-cut strands

DH.1000.02
Pack of 50 pieces
Opak. 50 szt.

- 1 Do czyszczenia mostów, aparatów ortodontycznych i większych przestrzeni międzyzębowych
- 2 Usztywniony koniec ułatwia wprowadzanie nici pod przęsło mostu lub aparatu ortodontycznego
- 3 Puszysta część służy oczyszczaniu miejsc wokół mostów i aparatów oraz większych przestrzeni międzyzębowych
- 4 Standardowa nić dentystyczna usuwa płytkę nazębną poniżej linii dziąseł
- 5 W pojemniku znajduje się 50 odmierzonych odcinków nitki dla łatwiejszego dozowania

Tongue cleaner / Szczoteczka do czyszczenia języka



DH.2200.0u



End Tufted Brush / Szczoteczki jedнопęczkowe

The brush has been developed in order to clean interstitially tooth by tooth.
The brush is equipped with a small ergonomically designed nylon tuft.

Idealna do czyszczenia pojedynczych zębów, okolic przyszyjkowych, bruzd zębowych oraz stałych aparatów ortodontycznych. Zakończona ergonomicznie zaprojektowanym małym nylonowym pęczkiem, pozwala na delikatne i efektywne czyszczenie.

CS 1006
single 6mm

CS 1009
single 9mm

CURAPROX

MIND THE GAP!

SUNSTAR
GUM
HEALTHY GUMS. HEALTHY LIFE.®

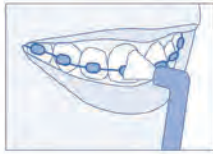

DH.2002.01

DH.2002.02

DH.2002.03

Orthodontic V-Trim toothbrushes
Szczoteczki ortodontyczne V-Trim

CURAPROX
MIND THE GAP!

SUNSTAR
GUM
HEALTHY GUMS. HEALTHY LIFE.®

Oral-B



DH.2011.01
Curaprox CS 5460



DH.2011.02
Gum Butler 124



DH.2011.00
Oral B

Orthodontic dual-head V-Trim toothbrushes
Podwójne szczoteczki ortodontyczne (z końcówką do czyszczenia przestrzeni międzyzębowych)



DH.2010.00 Blue / Niebieska
DH.2010.01 Green / Zielona
DH.2010.02 Purple / Purpurowa
DH.2010.03 Red / Czerwona

Orthodontic V-Trim travel toothbrushes
Podróżne szczoteczki ortodontyczne V-Trim



DH.2020.00 Blue / Niebieska
DH.2020.01 Green / Zielona
DH.2020.02 Purple / Purpurowa
DH.2020.03 Red / Czerwona

Orthodontic V-Trim toothbrushes
Szczoteczki ortodontyczne V-Trim



DH.2012.00 Blue / Niebieska
DH.2012.01 Green / Zielona
DH.2012.02 Purple / Purpurowa
DH.2012.03 Red / Czerwona

Disposable orthodontic V-Trim Prepasted toothbrush
Szczoteczki ortodontyczne jednorazowe V-Trim z pastą do zębów

Pack of 144 pieces / Opak. 144 szt.



DH.2091.00

Prepasted with mint tooth paste
Perfect for patients use prior to treatment

Pasta o smaku miętowym
Doskonale w sytuacjach awaryjnych

Toothbrush covers
Ostonki na główki szczoteczek manualnych

Pack of 144 pieces / Opak. 144 szt.



DH.2900.00

Denture brush
Szczoteczka do protez



DH.2300.00



Teen toothbrushes
Szczoteczki do zębów Teen



DH.2015.01 Blue / Niebieska
DH.2015.02 Green / Zielona
DH.2015.03 Orange / Pomarańczowa
DH.2015.04 Yellow / Żółta

Orthodontic care kits / Zestawy higieniczne

Give your patients everything they need to get through the "ordeal" of having to wear braces. They're a great way to show you care while encouraging oral hygiene during treatment so that patients get the most value out of their braces.
Zaoferuj swojemu pacjentowi wszystko to czego potrzebuje aby mu wynagrodzić trud noszenia aparatu stałego. To doskonały sposób okazania troski o pacjenta i zachęta do dbałości o higienę jamy ustnej.

Kit-III in plastic case / Zestaw w plastikowym etui



Orthodontic Care Kit / Zestaw higieniczny

DH.2000.04 Blue / Niebieski
DH.2000.05 Green / Zielony
DH.2000.06 Purple / Purpurowy
DH.2000.07 Red / Czerwony



Contents, 1 each / Zawiera po 1 sztuce:
Dual head V-Trim brush / Szczoteczka
V-Trim travel brush / Szczoteczka podróżna
Interproximal brush / Szczoteczka do przestrzeni międzyzębowych
3-minutes timer / 3 min. "klepsydra"
Mint wax / Wosk miętowy
Floss threaders / Igła do nici dentystycznej
15 yard mint floss spool / Nić dentystyczna na szpulce
Mouth mirror / Lusterko z rączką



Orthodontic care kits / Zestawy higieniczne

Give your patients everything they need to get through the "ordeal" of having to wear braces. They're a great way to show you care while encouraging oral hygiene during treatment so that patients get the most value out of their braces.

Zaferuj swojemu pacjentowi wszystko to czego potrzebuje aby mu wynagrodzić trud noszenia aparatu stałego. To doskonały sposób okazania troski o pacjenta i zachęta do dbałości o higienę jamy ustnej.

Kit-II in plastic bottle / Zestaw w plastikowym bidonie



Contents, 1 each / Zawiera po 1 sztuce:

- Dual head V-Trim brush / Szczoteczka
- V-Trim travel brush / Szczoteczka podróżna
- Interproximal brush / Szczoteczka do przestrzeni międzyzębowych
- Mint wax / Wosk miętowy
- Floss threaders / Igła do nici dentystycznej
- 15 yard mint floss spool / Nić dentystyczna na szpulce



Orthodontic Care Kit / Zestaw higieniczny

- DH.2001.00 Blue / Niebieski
- DH.2001.01 Green / Zielony
- DH.2001.02 Purple / Purpurowy

Kit-IV in plastic pouch / Zestaw w plastikowym etui



Contents, 1 each / Zawiera po 1 sztuce:

- V-Trim brush / Szczoteczka V-Trim
- V-Trim travel brush / Szczoteczka podróżna
- Interproximal brush / Szczoteczka do przestrzeni międzyzębowych
- 3-minutes timer / 3 min. "klepsydra"
- Orthodontic wax / Wosk ortodontyczny
- 15 yard mint floss spool / Nić dentystyczna na szpulce
- Mouth mirror mixing spatula / Lusterko z rączką



Orthodontic Care Kit / Zestaw higieniczny

- DH.2003.00 Blue / Niebieski
- DH.2003.01 Pink / Różowy

Kit-IV in plastic pouch / Zestaw w plastikowym etui



Contents, 1 each / Zawiera po 1 sztuce:

- V-Trim brush / Szczoteczka V-Trim
- V-Trim travel brush / Szczoteczka podróżna
- Interproximal brush / Szczoteczka do przestrzeni międzyzębowych
- 3-minutes timer / 3 min. "klepsydra"
- Orthodontic wax / Wosk ortodontyczny
- 15 yard mint floss spool / Nić dentystyczna na szpulce
- Mouth mirror mixing spatula / Lusterko z rączką



Orthodontic Care Kit / Zestaw higieniczny

- DH.2003.02 Blue / Niebieski
- DH.2003.03 Green / Zielony
- DH.2003.04 Purple / Purpurowy
- DH.2003.05 Red / Czerwony

Dental water flossers / Irygator stomatologiczny

waterpik®



DH.2500.01



Product Features

- 7 Tips
- Advanced Pressure Control System With 10 Settings
- Reservoir Capacity Of 90+ Seconds
- Pause Button On Handle
- 360-Degree Tip Rotation
- Smaller And Quieter Than Previous Models
- Covered Reservoir With Built-In Tip Storage
- Compatible With 120VAC/60Hz Outlets, For Use In North America Only
- Two-Year Warranty

Opis

Waterpik to nowoczesny irygator w 93% skuteczniejszy w profilaktyce zapalenia dziąseł od tradycyjnych metod czyszczenia nitką dentystyczną. Badania naukowe dowiodły że po 28 dniach używania irygatora nastąpiło w 40%-93% obniżenie krwawienia i zapalenia dziąseł. Zdrowsze dziąsła już po 14 dniach. Usuwa bakterie głęboko między zębami i poniżej dziąseł, gdzie czyszczenie tradycyjną szczoteczką nie daje rezultatów. Masuje dziąsła, nadając w efekcie ich silny i zdrowy wygląd

Idealny do czyszczenia wokół stałych aparatów ortodontycznych, dzięki zastosowaniu specjalnej końcówki. 10 stopni regulacji ciśnienia (od 5 do 90 Psi). Nowy wygląd oraz 20% cichszy niż poprzednie modele. Zbiornik z pokrywą ułatwia utrzymać go w czystości i przechowywać załączone akcesoria. Dwa lata gwarancji



DH.2500.03



Classic Jet tip
końcówki klasyczne
do irygacji



Orthodontic tip
Końcówka ortodontyczna



Plaque Seeker tip
końcówka do czyszczenia
implantów, mostów, koron



Pik Pocket tip
końcówka do irygacji
poddziałowej



Toothbrush tip
końcówka szczoteczka
do zębów



Tongue cleaner tip
końcówka do czyszczenia języka



Expansion screws / Śruby rozszerzające

Micro Series

Double-guidance expansion screws for multiple use.
Podwójne śruby prowadzące o szerokim zastosowaniu.

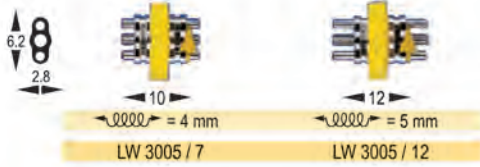

Skeleton-type sector screws for use as distal screws and for single-tooth movements.
Stable U-bow retention, straight or bent.
Śruby szkieletowe, sekcyjne do przesuwania poszczególnych zębów, proste lub kątowe.

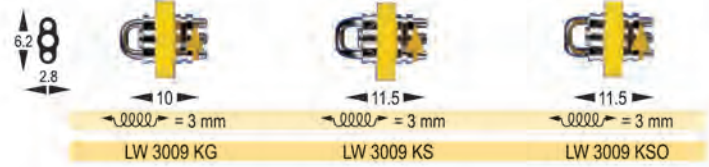

Standard Series

Skeleton-type sector screws for use as distal screws and for single-tooth movements. Stable U-bow retention, straight or bent.
Śruby szkieletowe, sekcyjne do przesuwania poszczególnych zębów, proste lub kątowe.

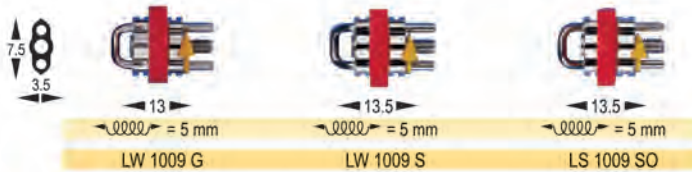

Traction screws for closing gaps. Stable U-bow retention straight or bent.
Śruby trakcyjne, ściągające do zamykania przestrzeni międzyzębowych, proste lub kątowe.

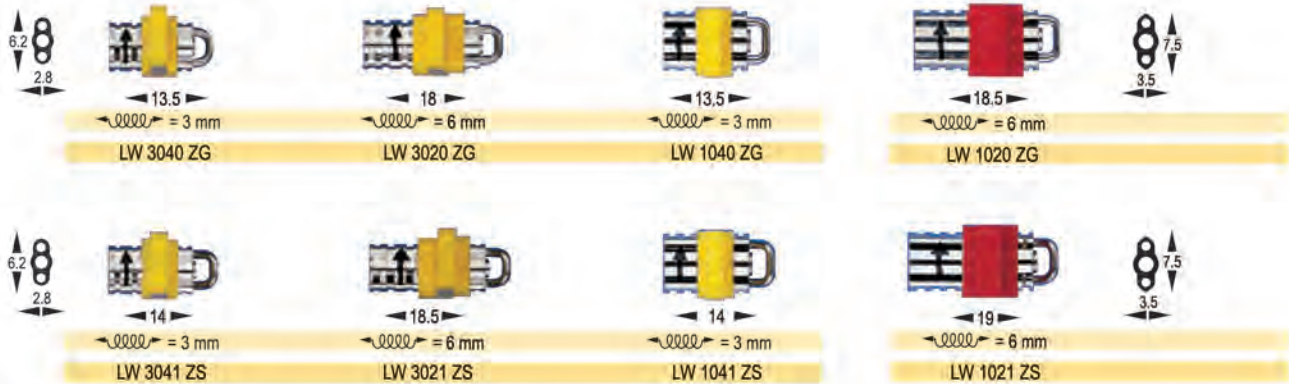

Stable expansion screws for the maxilla with retention drill holes.
Śruby szkieletowe, rozszerzające z zamkniętym otworem, typowe dla szczęki.

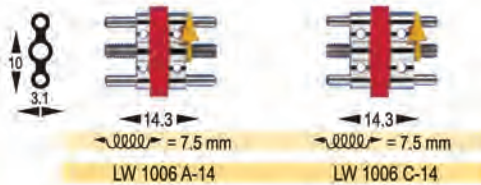

Standard expansion screws
Śruby rozszerzające standard



Skeleton design
Holes in body of screws for better retention in acrylic
Built-in stops prevent screws from coming apart
With expansion screw key straight, small - standard

Stable expansion screws for the mandible with retention drill holes.
Śruby szkieletowe, rozszerzające z zamkniętym otworem, typowe dla żuchwy.

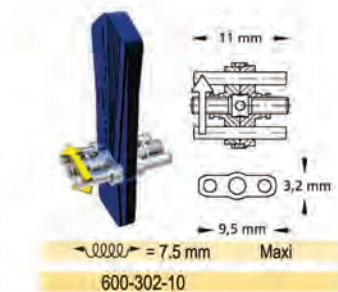
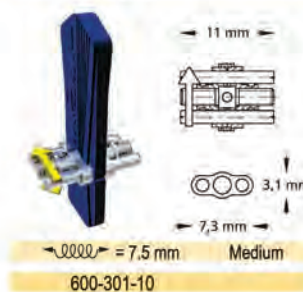
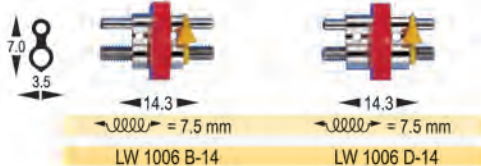



Expansion screws / Śruby rozszerzające

Multiple section screws by Bertoni / Śruby Bertonięgo

Combined transversal and protrusion screw for 2 or 3 independently adjustable sectors.
Śruby poprzeczno-protruzyjne z 2 lub 3 niezależnie działającymi sekcjami, trójkierunkowe.



Special screws / Śruby specjalne

Fan-shaped screw for asymmetric expansion of the maxilla.
Śruba zawiasowa górna do przesuwania zębów w poprzek łuku zębowego w odcinku przednim szczęki.

Mandibular bow screws for transversal expansion of the mandibular anterior arch.
Śruby zawiasowe dolne do przesuwania zębów w poprzek łuku zębowego w odcinku przednim żuchwy.

Stable expansion screw for the upper jaw.
Śruba Weise'a do leczenia przodozryzu.

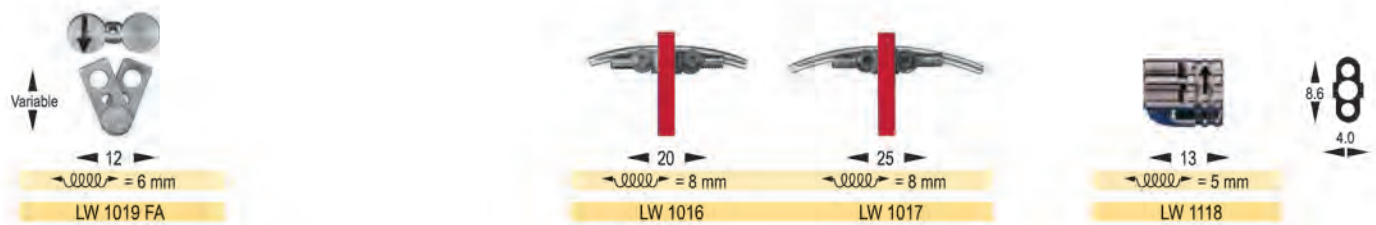

Palatal suture expansion screws / Śruby do podniebiennych procesów rozszerzających



Laboratory wires / Drut protetyczny

High quality chromium-nickel dental wires, quality soft, hard and spring hard.

Wysokiej jakości drut protetyczny chromowo-niklowy – miękki, twardy, sprężysto – twardy.



Size Rozmiar	Hard Twardy	Spring hard Sprężysto – twardy	Length Długość
0,4 mm	L 804	L 904	50 m
0,5 mm	L 805	L 905	50 m
0,6 mm	L 806	L 906	40 m
0,7 mm	L 807	L 907	30 m
0,8 mm	L 808	L 908	20 m
0,9 mm	L 809	L 909	10 m
1,0 mm	L 810	L 910	10 m
1,1 mm	L 811	L 911	10 m
1,2 mm	L 812	L 912	10 m



Remanium® wires / Drut Remanium®

Size Rozmiar	Spring hard Sprężysto – twardy	Length Długość
0,7 mm	523-070.00	30 m
0,8 mm	523-080.00	20 m
0,9 mm	523-090.00	20 m

Thermoform sheets / Płytki termoformowalne

CRYSTAL PLATE 0,5mm - PVC
 • Whitening / Fluoride application tray.

CRYSTAL PLATE 0,75 / 1,0 / 1,5 / 2,0
 • Bite plate (bruxism) / Base plate;
 • Orthodontic Aligners;
 • Space retainer Try-on of wax Surgical Guide.

SOFT PLATE 1,0mm - EVA
 • Whitening / Fluoride application tray.

SOFT PLATE 2,0mm - EVA
 • Mouth protector / Miorelaxing

SOFT (EVA-Borrachoide) 3,0 / 4,0mm
 • Mouthguard / Miorelaxing

Thickness / Grubość	Round / okrągłe ø 127 mm	Square / Kwadratowe 127 x 127 mm
0.50 mm / .020"	3A GS020R	3A GS020
0.75 mm / .030"	3A GS030R	3A GS030
1.00 mm / .040"	3A GS040R	3A GS040
1.50 mm / .060"	3A GS060R	3A GS060
2.00 mm / .080"	3A GS080R	3A GS080

Thickness / Grubość	Round / okrągłe ø 127 mm	Square / Kwadratowe 127 x 127 mm
0.50 mm / .020"	3A GB020R	3A GB020
1.00 mm / .040"	3A GB040R	3A GB040
1.50 mm / .060"	3A GB060R	3A GB060
2.00 mm / .080"	3A GB080R	3A GB080
3.00 mm / .0120"	3A GM120R	3A GM120
4.00 mm / .0160"	3A GM160R	3A GM160

Orthodontic Instruments / Instrumenty ortodontyczne





Instruments for "Fixed Appliance Technique" Narzędzia do techniki aparatów stałych

Measuring instruments / Instrumenty do pomiarów

Vernier caliper / Suwmiarka

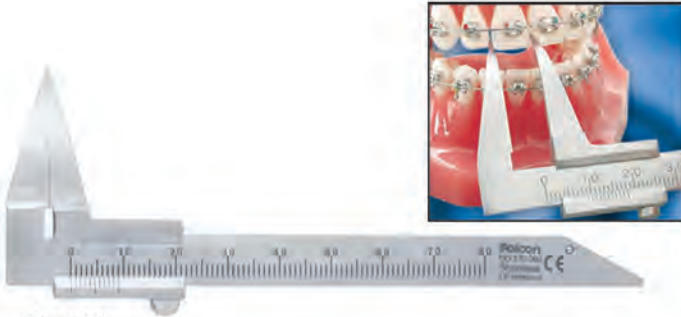

DO.170.000
Beerendonk

Vernier with long and fine tips for intraoral measurements.
Suwmiarka z długimi, cienkimi końcówkami do pomiarów wewnątrzustnych.



DO.172.000
Falcon

Double sided, for inner and outer measurements
Dwustronna, do pomiarów wewnętrznych i zewnętrznych

Orthodontic ruler / Linijka ortodontyczna



DO.160.000
Bernklau

Perfect for all diagnostic measurements, both intraoral and on the model.
Idealna do pomiarów diagnostycznych, zarówno wewnątrzustnych jak i na modelu

Rulers stainless steel / Linijki ze stali nierdzewnej

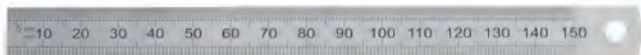

BA.225.150 150 mm / 6"



BA.225.300 300 mm / 12"

Bow divider / Cyrkiel

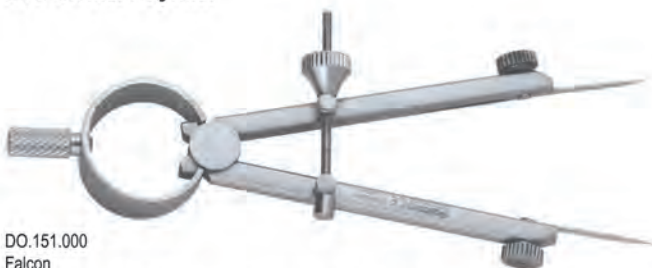

DO.151.000
Falcon

To measure tooth width, bracket distance to the incisal edge etc.
Do mierzenia szerokości zębów, odległości zamka od brzegu siecznego, itp.

Orthodontic bow compass / Cyrkiel ortodontyczny



DO.175.000
Falcon

To measure tooth width, bracket distance to the incisal edge etc.
Do mierzenia szerokości zębów, odległości zamka od brzegu siecznego, itp.

IPR distance control gauge set / IPR linijka do mierzenia dystansu

Manual stainless steel instrument for the measurement and control of tooth distances heated during IPR protocols. During orthodontic treatments using the interproximal stripping process, predefined and measured interdental spaces must be created. With the stripping method, measurable and calibrated spaces are created through the removal of dental tissue in order to obtain exactly the space necessary for the movement of teeth into a harmonious and correct position.



DO.299.000



DO.299.001

Instruments for "Fixed Appliance Technique" Narzędzia do techniki aparatów stałych



Dynamometer / Dynamometr

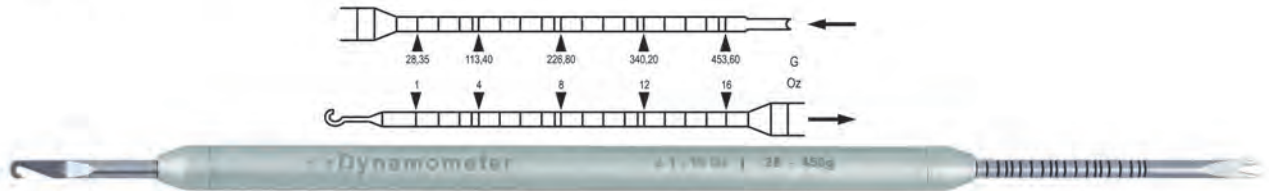

DO.180.000

"High precision gauge for measuring tensile and compression forces exerted by springs and elastics for a maximum range of 16 oz. (453gm). It is calibrated with 1 oz. single line and 4 oz. double line increments."

"Przyrząd do pomiaru siły naciągu wyciągów elastycznych i sprężynek. Maksymalna siła - 16 oz. (453g). Dynamometr jest kalibrowany, jedno nacięcie oznacza 1oz, dwa nacięcia 4oz."

Instruments for bands and buccal tubes / Instrumenty do pierścieni i rurek

Band pusher / Dociskacz pierścieni



Band pusher with serrated rectangular tip for good transfer of force when positioning bands.

Narzędzie Mershon z ząbkowaną prostokątną końcówką do dociskania pierścieni, zapewniającą dobre przeniesienie siły nacisku



DO.120.010
Mershon

Band seating instruments / Nagryzacz do pierścieni



Autoclavable
Możliwość sterylizacji w autoklawie



DO.125.010

Buccal tube tweezers / Pensety do zakładania rurek



Fine pointed tips firmly grip buccal tube within slot for accurate placement.

Cienkie końcówki pewnie chwytają slot w rurce i umieszczają ją w odpowiednim miejscu



DO.227.120 120 mm
DO.227.135 135 mm
Keat



DO.228.125 125 mm
DO.228.135 135 mm
Falcon

Deluxe Band seating instruments (Bite sticks) Deluxe Nagryzacz do pierścieni

High heat resistant band seating instruments (Bite sticks) with stand temperatures up to 188 °C
Nagryzacz odporne na wysoką temperaturę, sterylizacja do 188 °C



DO.126.000
Standard triangular tip
Końcówka w kształcie standardowego trójkąta



DO.126.010
Reverse triangular tip
Końcówka w kształcie odwróconego trójkąta



DO.126.020
Circular tip
Końcówka w kształcie okręgu



DO.126.030
Star shaped tip
Końcówka w kształcie gwiazdy



Band pushers - scalers Dopychacz pierścieni - sierpy

Sharp scaling tip on one end and serrated band pusher on the other.
Ostry sierp do kamienia nazębnego i dociskacz pierścieni z ząbkowaną końcówką



DO.130.010



DO.130.014



Instruments for "Fixed Appliance Technique" Narzędzia do techniki aparatów stałych

Disc safety guard set / Zestaw ochroniaczy do tarczy ściernej



Protects patients gums, lips and cheeks from rotating discs.

Ochronia dziąsła, policzki i wargi pacjenta przed wirującą tarczą.

DO.300.000

Contents / Zawiera:

1 x Shaft / Tuleja

1 x 8mm Guard / Ochroniacz

1 x 16mm Guard / Ochroniacz

1 x 22mm Guard / Ochroniacz



22 mm

16 mm

8 mm

Interproximal reduction strips / Paski separacyjne

M.I.R is indicated for use in interproximal and contact reduction, mesial/distal finishing and contouring, crown and bridge cement removal and cleanup.



Double sided perforated / dwustronne perforowane

Each / Sztuka

Code / Kod	Grit size /	Color / Kolor
DO.299.051	Extra fine	Yellow
DO.299.052	Fine	Red
DO.299.053	Medium	Blue
DO.299.054	Coarse	Green
DO.299.055	Extra coarse	Pink

Instruments for interdental stripping Instrumenty do międzyzębowej redukcji szkliwa

Manual interdental stripper handle

Trzymadło do pasków separacyjnych

Securely holds all types of abrasive strips

Opracowane dla pewnego chwytania pasków ściernych



DO.298.000

Handle for Interproximal reduction strips Trzymadło do pasków separacyjnych

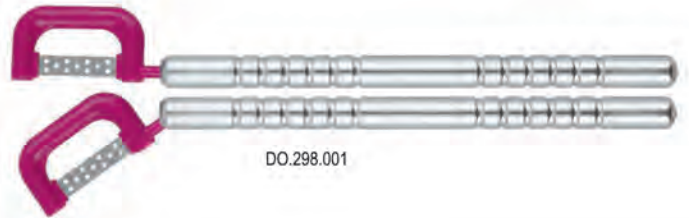

DO.298.001

Abrasive strips / Paski separacyjne

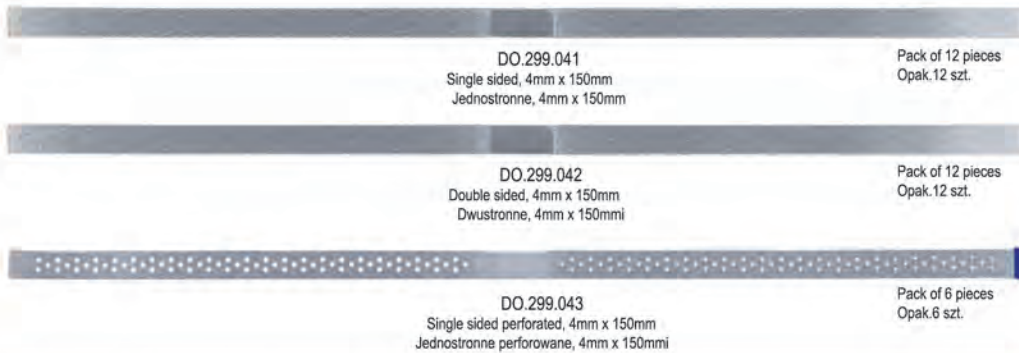

Gum flap retractor / Odciągacz płata dziąsła



Useful instrument for lifting gum while banding of second molar.

Praktyczne narzędzie do odciągania płata dziąsła podczas nakładania pierścienia na drugi ząb trzonowy.

DO.145.010

Bracket positioning gauge / Pozycjoner do zamków



Facilitate bracket positioning to exact desired distance by measuring its height, from slot to incisal/occlusal surface of tooth

Pozwala na precyzyjne ustawienie zamka, mierząc odległość pomiędzy slotem zamka a brzegiem siecznym zęba



Universal for both .018" or .022" slot brackets.
Four different heights for bracket positioning: 3.5, 4, 4.5, & 5 mm

Uniwersalne narzędzie do zamków o slotach .018" i .022" z czterema wysokościami położenia zamka: 3,5; 4; 4,5; 5 mm.

DO.200.010
Boone

Instruments for "Fixed Appliance Technique" Narzędzia do techniki aparatów stałych



Instruments for D.B. brackets / Instrumenty do zamków D.B.

Falcon bracket positioning gauges / Pozycjonery do zamków Falcon

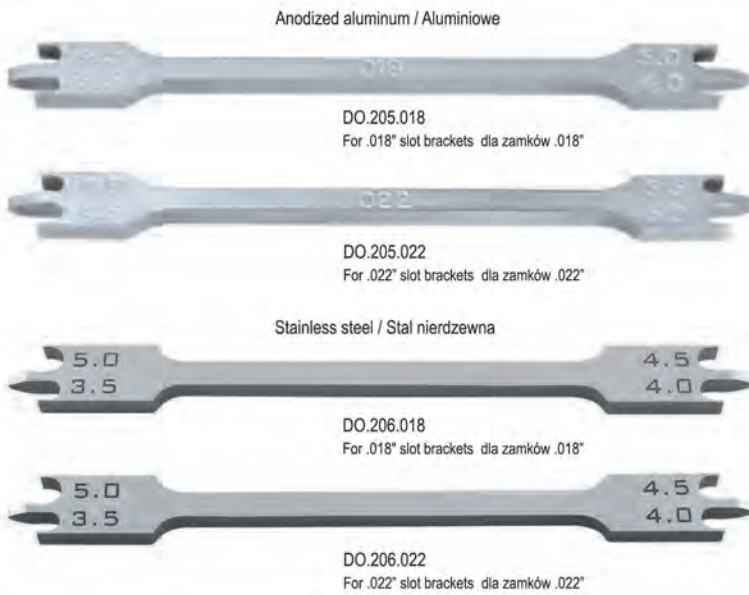

Four different heights for bracket positioning: 3.5, 4, 4.5, & 5 mm
Two different models for .018" or .022" slot brackets, anodized aluminum

Cztery wysokości położenia zamka: 3,5; 4; 4,5; 5 mm.
Dwa modele dla zamków o slotach .018" i .022", aluminium anodyzowane, możliwość sterylizacji w autoklawie

Bracket positioning gauge movable / Pozycjoner do zamków z ruchomymi końcówkami



Adhesive removers / Instrumenty do usuwania kleju

For removing residue of adhesive from tooth after removal of D.B. brackets
Usuwanie pozostałości kleju z zębów po zdjęciu zamków

Classic Found

6 mm solid handle
6 mm pełny uchwyt



Autoclavable
Możliwość sterylizacji w autoklawie



DO.235.010

SOFT LINE INSTRUMENTS
soft and sure grip



DO.235.014

Orthodontic utility plier for brackets placement / Penseta do zakładania zamków z lusterkiem

Laser printed gauge 4.0 mm - 5.0 mm, 3.5 mm - 4.5 mm
Laserowo oznaczona podziałka 4.0 mm - 5.0 mm, 3.5 mm - 4.5 mm



Ergonomic – engineered for comfort while working
Time earning – no need to change tool during brackets positioning lowering costs –
one tool instead of four Full attention to the patient – no need to turn head for tool replacing

Patent released to Dr. Stefano Di Vecchio, Patent no RM2000 U000 150



Instruments for "Fixed Appliance Technique" Narzędzia do techniki aparatów stałych

Instruments for D.B. brackets / Instrumenty do zamków D.B.

Bracket placing tweezers / Pensety do zakładania zamków



DO.210.135
135 mm



DO.217.135
135 mm



DO.220.110
110 mm

Bracket tweezers with slot aligner Pensety do zakładania zamków z regulatorem slotów



Bracket holder on one end and slot aligner on the other.
The rear end fits into the bracket slot for accurate placement.

Pozycjoner na końcu pensety pozwala na dokładne ustawienie zamka.
Przednia część pensety służy do chwytania zamków.



Fig. 1
DO.213.135
135 mm



Fig. 2
DO.214.135
135 mm



Fig. 3
DO.215.135
135 mm

Tungsten carbide debonding burs Wiertła z węglika spiekanego do usuwania kleju



Size / Rozmiar \varnothing 1/10 mm 014
OAL 19 mm
C21R 500.314.137.006.... 014



Size / Rozmiar \varnothing 1/10 mm 014
OAL 19 mm
CF134 500.314.164.071.... 014



Size / Rozmiar \varnothing 1/10 mm 016
OAL 19 mm
C23R 500.314.194.006.... 016

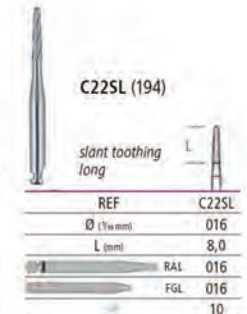

C22SL (194)
slant tothing long
REF C22SL
 \varnothing (1/16mm) 016
L (mm) 8,0
RAL 016
FGL 016
10



REF CBR15
 \varnothing (1/16mm) 016
L (mm) 5,0
RA 016
10



REF CBR1V
 \varnothing (1/16mm) 018
L (mm) 8,0
RA 018
10



C22G (194)
straight tothing
REF C22G
 \varnothing (1/16mm) 016
L (mm) 5,0
RA 016
FG 016
10

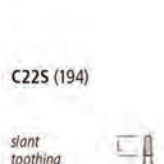

C22S (194)
slant tothing
REF C22S
 \varnothing (1/16mm) 016
L (mm) 5,0
RA 016
FG 016
10

Bracket placer for posterior teeth Penseta do zakładania zamków na zębach trzonowych



Very helpful instrument for placing D.B. brackets from bicusps to molars, the small head offers excellent view.

Niezawodny instrument do zakładania zamków D.B. na zębach przedtrzonowych i trzonowych. Mała "główka" pensety zapewnia doskonale pole widzenia.



DO.209.010

Instruments for "Fixed Appliance Technique" Narzędzia do techniki aparatów stałych



Elastic ligature applicators / Instrumenty do nakładania ligatur elastycznych

For easy placement of elastic ligatures under bracket tie wings / Umożliwiają łatwe założenie ligatur elastycznych pod skrzydełka zamka.

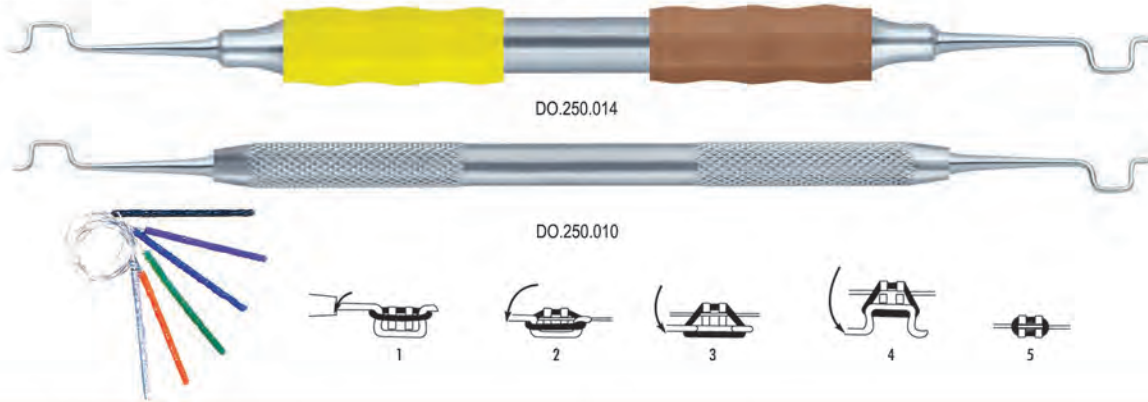

Elastomeric ligature removing instruments / Instrumenty do usuwania ligatur elastycznych

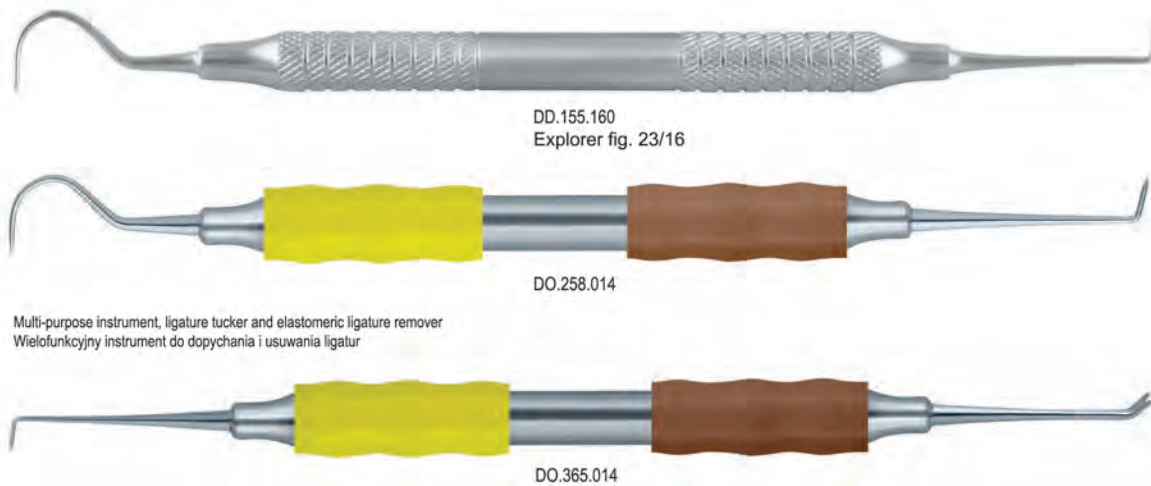

Multi-purpose instrument, ligature tucker and elastomeric ligature remover
Wielofunkcyjny instrument do dopychania i usuwania ligatur

Ligature tuckers / Dopychacze ligatur (widelce)

Used to tuck metal ligatures, also useful for inserting arch wires into bracket slots and applying elastic chains. Straight end is for anterior use and angled of posterior
Niezawodne instrumenty do dociskania ligatur metalowych, umieszczania łuków w slotcie zamka oraz zakładania łańcuszków elastycznych.

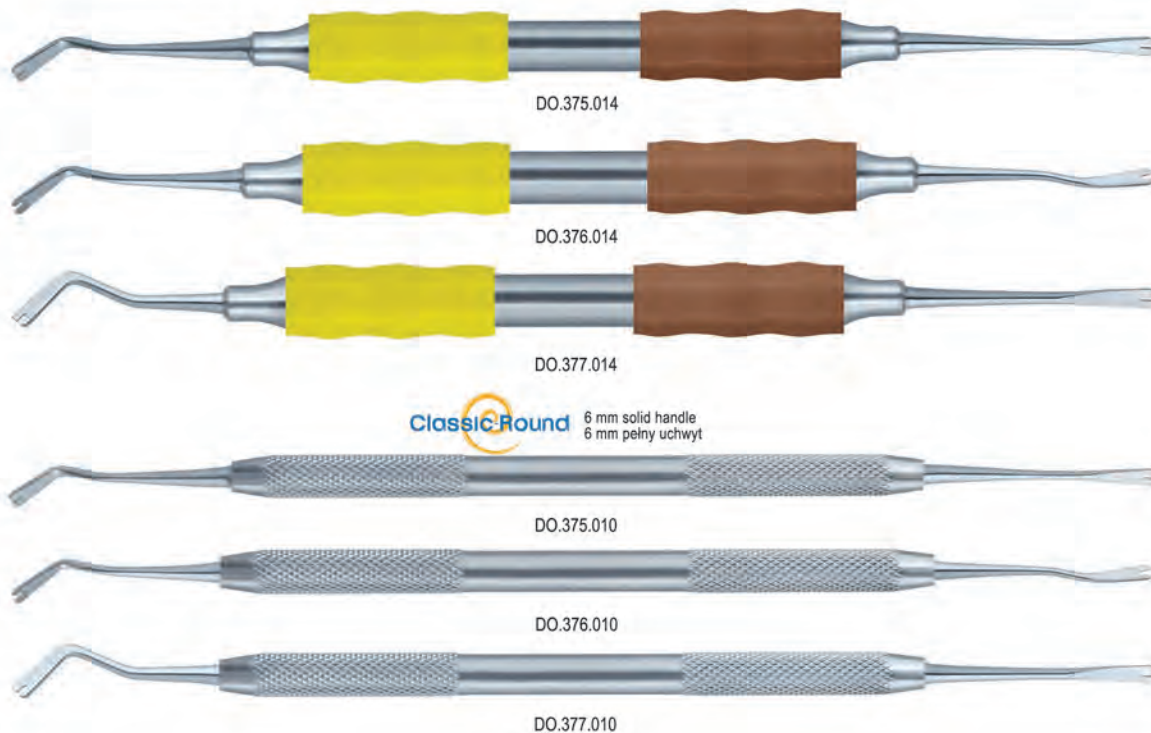



Instruments for "Fixed Appliance Technique" Narzędzia do techniki aparatów stałych

Elastic ligature placing forceps Kleszczyki do nakładania ligatur elastycznych

Elastic ligature placing forceps with hook
Excellent for placing elastic ligatures, hook on tip provides non-slip grip of any type of elastomeric.

Kleszczyki z haczykiem do nakładania ligatur elastycznych
Doskonałe narzędzie do nakładania ligatur elastycznych, elastomery * nie wyslizgują się* dzięki haczykowi na końcówce kleszczyków.



DO.290.120
Falcon
120 mm
Straight / Proste



DO.291.120
Falcon
120 mm
Curved / Zagięte



DO.294.140
Falcon
140 mm

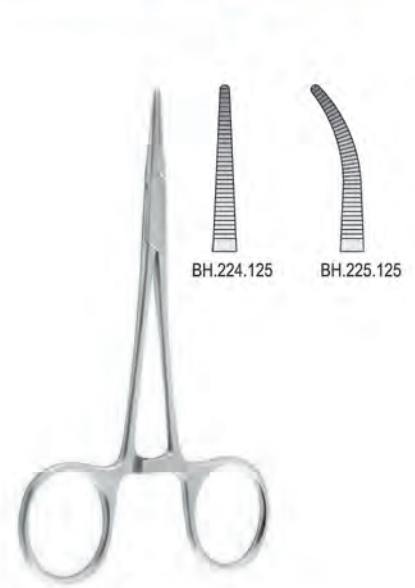

Halsted Mosquito
125 mm

Elastic ligature placing forceps with groove Kleszczyki z rowkowanymi końcówkami do nakładania ligatur elastycznych

Excellent for placing elastic ligatures, grooved tip provides non-slip grip of any type of elastomeric

Doskonałe narzędzie do nakładania ligatur elastycznych, elastomery * nie wyslizgują się* dzięki rowkowanym końcówkom kleszczyków.

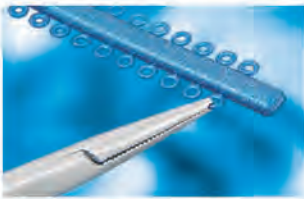

DO.292.120
Falcon
120 mm



DO.295.140
Falcon
140 mm

Elastomeric ligature removing tweezers Penseta do usuwania ligatur elastycznych

For easy removal of elastomeric ligatures

Zapewnia łatwe usunięcie ligatur elastycznych



DO.285.010



Separators placing pliers / Kleszce do zakładania separatorów

For easy placement of radiopaque and non-radiopaque separators
Zapewniają łatwe umieszczenie separatorów widocznych i niewidocznych na zdjęciach RTG



DO.270.160
160 mm



DO.271.165
155 mm



DO.272.165
165 mm



DO.270.155
155 mm



Instruments for "Fixed Appliance Technique" Narzędzia do techniki aparatów stałych

Ligature tying pliers / Kleszce do napinania ligatur



DO.385.160
Coon

Most popular pliers for tying stainless steel ligatures. Unique cam design incorporates a precision-chamfered slot which automatically locks wire ends as tips spread

Najpopularniejsze kleszce do wiązania ligatur metalowych. Niepowtarzalny projekt krzywki z unikalnym nacięciem pozwala na automatyczne zawiązanie ligatury przy rozwarciu końcówek.



DO.388.160
Steiner

Dished tying cam for easy wrapping and V-notch for easy winding, cam extends away from the body for ease of winding and locking wire. Dished cam can be reversed for left-handed operators

Wklęsły profil krzywki zapewnia szybkie nawinięcie ligatury, a nacięcie w kształcie litery V pozwala na jej łatwe związanie. Odległość krzywki od narzędzia ułatwia zawiązywanie drutu. Dla osób leworęcznych możliwe jest przełożenie krzywki na drugą stronę

Ligature pliers / Kleszki do ligatur

Falcon offers wide variety of pliers for ligatures wires with or without tungsten carbide inserts. Falcon and Smaha pattern pliers have finer tips than standard Mathieu patterns, these are also suitable for placing elastic ligatures

Falcon oferuje szeroki wybór kleszczyków do ligatur z wkładką z węgla spiekane lub bez niej. Kleszczyki Falcon i Smaha mają cieńsze końce niż standardowe kleszczyki Mathieu, są także odpowiednie do zakładania ligatur elastycznych.

FALCON with tungsten carbide inserts
z wkładką z węgla spiekane



DO.392.010



DO.392.020



DO.392.030



DO.395.140



DO.396.140



DO.393.030
Falcon
140 mm



Instruments for "Fixed Appliance Technique" Narzędzia do techniki aparatów stałych



Distal end bending instruments Instrumenty do zaginania końcówek dystalnych

Very useful instrument for bending archwire distal ends to the buccal tube to create an easy cinch back bend in an area which is usually very hard to reach. Simply insert instrument to distal end of wire extracting through buccal tube and twist forward. Also can be used to bend tails of springs.

Niezawodny instrument do zaginania końcówek dystalnych w kierunku rurek policzkowych w miejscach trudnodostępnych. Koniec drutu wystającego z rurki policzkowej należy wsunąć w instrument i zagiąć do przodu. Narzędziem tym można również zaginać końcówki sprężynek.



DO.240.010
For wire upto .022" (0.56 mm)
Do drutu max ø .022" (0.56mm)

DO.240.020
For wire upto .030" (0.76 mm)
Do drutu max ø .030" (0.76mm)



DO.241.010
For wire upto .022" (0.56 mm)
Do drutu max ø .022" (0.56mm)

DO.241.020
For wire upto .030" (0.76 mm)
Do drutu max ø .030" (0.76mm)



DO.240.035
For wire upto .022" (0.56 mm) and .030" (0.76 mm)
Do drutu max ø .022" (0.56mm) i .030" (0.76 mm)

Lingual torquing key Instrument do pozycjonowania łuku na powierzchni językowej



DO.400.014

Tweezers for lingual appliances Penseta do zakładania akcesoriów językowych



DO.401.135
135mm

NiTi ice instrument / Instrument do aktywacji łuków NiTi



DO.245.010
Turns NiTi wire soft and flexible immediately for faster wire placement
Zmienia łuki Niklowo-Tytanowe, które stają się bardziej miękkie i elastyczne

Turrets for arch forming / Trzpienie do formowania łuków

For wires / Do łuków
.016" - .022" (0.41mm - 0.56 mm)



135° C
Autoclavable
Możliwość sterylizacji w autoklawie

Torque / Tork
5°, 7° DO.912.010
10°, 13° DO.912.020



DO.911.010
Without torque / Bez torku



DO.910.010
Without torque / Bez torku

Non-autoclavable /



Instruments for "Fixed Appliance Technique" Narzędzia do techniki aparatów stałych

Distal end cutter with safety hold, mini head
Kleszce dystalne do cięcia i trzymania drutu, główka mini



DO.536.200
Falcon Mini

- Max. 0.30 mm to 0.50 mm (.012" to .020")
- Max. 0.46 mm x 0.64 mm (.018" x .025")
- ⊗ Max 0.38 mm to 0.53 mm (.0155" to .0215")
- ⊠ Max. 0.53 mm x 0.64 mm (.021" x .025")

Distal end cutter with safety hold mini head, long handles
Kleszce dystalne do cięcia i trzymania drutu, główka mini z długim uchwytem



DO.542.200
Falcon Mini

- Max. 0.30 mm to 0.50 mm (.012" to .020")
- Max. 0.46 mm x 0.64 mm (.018" x .025")
- ⊗ Max 0.38 mm to 0.53 mm (.0155" to .0215")
- ⊠ Max. 0.53 mm x 0.64 mm (.021" x .025")

Flush-cut Distal end cutter with safety hold
Kleszce dystalne do cięcia i trzymania drutu



DO.545.200
Falcon

- Max. 0.30 mm to 0.50 mm (.012" to .020")
- Max. 0.46 mm x 0.64 mm (.018" x .025")
- ⊗ Max 0.38 mm to 0.53 mm (.0155" to .0215")
- ⊠ Max. 0.53 mm x 0.64 mm (.021" x .025")

Distal end cutter with safety hold, long handle
Kleszce dystalne do cięcia i trzymania drutu z długim uchwytem



30-550SLS
147mm

- Max. 0.30 mm to 0.50 mm (.012" to .020")
- Max. 0.46 mm x 0.64 mm (.018" x .025")
- ⊗ Max 0.38 mm to 0.53 mm (.0155" to .0215")
- ⊠ Max. 0.53 mm x 0.64 mm (.021" x .025")

Instruments for "Fixed Appliance Technique"
Narzędzia do techniki aparatów stałych



Hard wire cutter, straight
Kleszcze do cięcia twardego drutu, proste



DO.550.200
Falcon

- Max. 0.30 mm to 0.50 mm (.012" to .020")
- Max. 0.56 mm x 0.71 mm (.022" x .028")

Hard wire cutter, Angled 15°
Kleszcze do cięcia twardego drutu, kątowe 15°



DO.555.200
Falcon

- Max. 0.30 mm to 0.50 mm (.012" to .020")
- Max. 0.56 mm x 0.71 mm (.022" x .028")

Soft wire and ligature cutter, mini
Kleszcze do cięcia ligatur, mini



DO.571.200
Falcon-Mini

- ┌ .25 mm to .38 mm (.010" to .015")

Soft wire and ligature cutter, standard
Kleszcze do cięcia ligatur, standardowe



DO.574.200
Falcon-Standard

- ┌ .25 mm to .38 mm (.010" to .015")

Soft wire and ligature cutter, mini
Kleszcze do cięcia ligatur, mini



TASK
Made in Japan



60-605S
Task-Mini

- ┌ .25 mm to .38 mm (.010" to .015")

Soft wire and ligature cutter, 15° angled
Kleszcze do cięcia ligatur, kątowe 15°



TASK
Made in Japan



60-607
Task-Mini

- ┌ .25 mm to .38 mm (.010" to .015")



Instruments for "Fixed Appliance Technique" Narzędzia do techniki aparatów stałych

Soft wire and ligature cutter, standard
Kleszcze do cięcia ligatur, standardowe

TASK

Made in Japan



30-604WK
Task-Standard

.23 mm to .30 mm (.009" to .012")

Ligature forming pliers
Kleszcze do formowania ligatur



DO.580.700
Falcon

.25 mm to .38 mm (.010" to .015")

Band removing pliers, long
Kleszcze do zdejmowania pierścieni proste



Falcon
Safely and quickly removes posterior bands. Pad rests on occlusal surface and tip catches edge of band.

Falcon
Szybko i pewnie usuwają pierścienie z zębów trzonowych. Specjalna podkładka na jednej z końcówek kleszczy spoczywa na powierzchni zęba podczas gdy druga z końcówek podważa krawędź pierścienia i tym samym zdejmuje go.

DO.492.300
Falcon



DO.495.010
Replacement pads 4.8 mm (1/4"), 2 pieces
Wymienna plastikowa końcówka 4.8mm (1/4") para

DO.495.020
Replacement pads 6.3 mm (3/16"), 2 pieces
Wymienna plastikowa końcówka 6.3mm (3/16") para

Contouring pliers
Kleszcze konturowe



DO.465.300
Johnson

One convex and one concave tip for contouring and adapting bands or crowns

Wklęsło-wypukłe do konturowania pierścieni lub koron

Contouring pliers for contouring and adapting bands or crowns / Kleszcze do konturowania pierścieni lub koron



DO.475.300
Reynolds



Band crimping plier
Kleszcze do zaciskania pierścieni

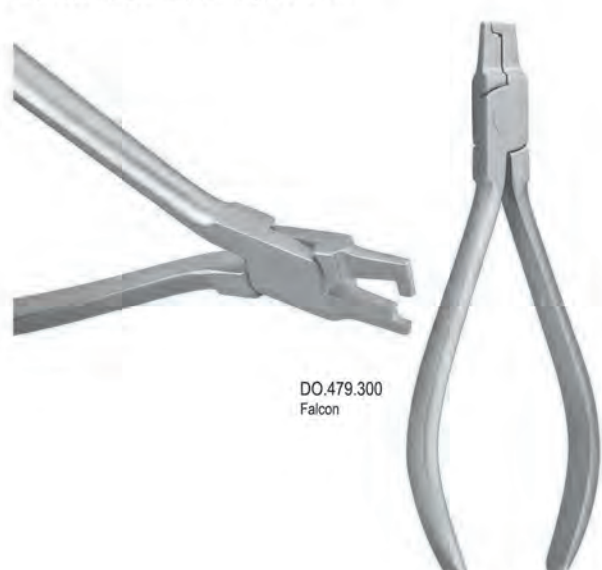

DO.479.300
Falcon



Bracket removing pliers
Kleszce do zdejmowania zamków

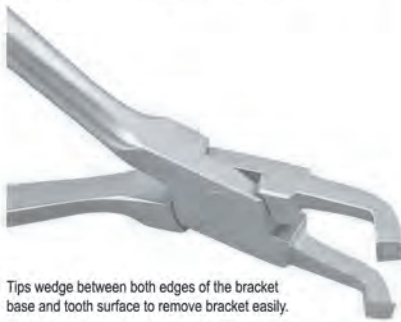

Tips wedge between both edges of the bracket base and tooth surface to remove bracket easily.

Końcówki kleszczy opierają się na krawędziach zamka, co pozwala na jego szybkie usunięcie.

The 60° angled tip allows easy access to posterior brackets

Końcówka wygięta pod kątem 60° pozwala na łatwy dostęp do zamków na przedtrzonowcach



DO.510.300
Falcon

Bracket removing pliers
Kleszce do zdejmowania zamków

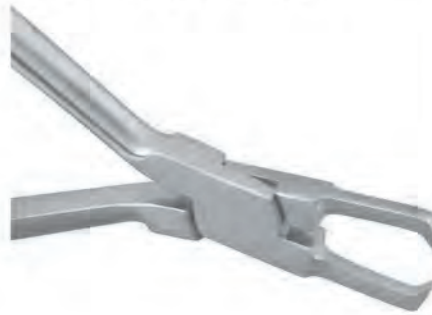

Bracket removing pliers straight
Kleszce do zdejmowania zamków proste



DO.511.300
Falcon

Bracket removing pliers with plastic tip
Kleszce do zdejmowania zamków z plastikową podkładką



Safely and quickly removes D.B. brackets, soft pad rest on incisal/occlusal surface of tooth for leverage and is comfortable for patient, sharp tip wedge the bracket base, one squeeze easily remove the bracket without extra force

Szybko i bezpiecznie zdejmują zamki, plastikowa podkładka spoczywa na powierzchni zęba podczas gdy druga końcówka kleszczy podważa podstawę zamka. Jedno ściśnięcie łatwo usuwa zamek bez konieczności używania większej siły.



DO.520.300
Falcon

Adhesive removing pliers
Kleszce do usuwania kleju



Bracket removing pliers straight
Kleszce do zdejmowania zamków proste



DO.525.010 Replacement metal tip
Wymienna metalowa końcówka

DO.525.700
Falcon



The most popular and versatile pliers for wire bending and loop forming, the tips are extremely fine for making small loops

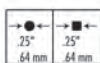

Najpopularniejsze kleszce do doginania drutu i formowania pętli. Wąskie końcówki kleszczy umożliwiają wykonanie małych pętli.



DO.592.300
Angle
Bird beak pliers



Light wire bending and loop forming pliers
Kleszce do zaginania drutu i formowania pętli



● 0.36 mm to 0.50 mm (.012" to .020")
■ Max. 0.41 mm x 0.56 mm (.016" x .022")

DO.610.300
Falcon

● 0.36 mm to 0.71 mm (.014" to .028")
■ Max. 0.56 mm x 0.71 mm (.022" x .028")



Instruments for "Fixed Appliance Technique"

Narzędzia do techniki aparatów stałych

Utility pliers Kleszcze wielofunkcyjne

Falcon with tungsten carbide inserts
z końcówką z węgla spiekanego



Slim design for better accessibility
in posterior and lingual areas

Smukła konstrukcja umożliwia
dotarcie w trudnodostępne miejsca np.
zębów trzonowych.

- Max. 0.30 mm to 0.50 mm (.012" to .020")
- Max. 0.56 mm x 0.71 mm (.022" x .028")

DO.735.100
Weingart Mini

Falcon with tungsten carbide inserts
z końcówką z węgla spiekanego



- Max. 0.30 mm to 0.50 mm (.012" to .020")
- Max. 0.56 mm x 0.71 mm (.022" x .028")

DO.738.100
Weingart



Slim design for better accessibility
in posterior and lingual areas

Smukła konstrukcja umożliwia
dotarcie w trudnodostępne miejsca np.
zębów trzonowych.

- Max. 0.30 mm to 0.50 mm (.012" to .020")
- Max. 0.56 mm x 0.71 mm (.022" x .028")

DO.735.300
Weingart Mini



- Max. 0.30 mm to 0.50 mm (.012" to .020")
- Max. 0.56 mm x 0.71 mm (.022" x .028")

DO.738.300
Weingart



Narrow long tips for better access to hard to reach
areas

Wąskie i długie końcówki kleszczy ułatwiają
dotarcie do trudnodostępnych miejsc.

- Max. 0.30 mm to 0.50 mm (.012" to .020")
- Max. 0.56 mm x 0.71 mm (.022" x .028")

DO.736.300
Weingart Narrow

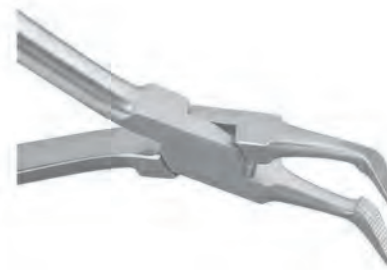

Angled 45°
Kątowe 45°

- Max. 0.30 mm to 0.50 mm (.012" to .020")
- Max. 0.56 mm x 0.71 mm (.022" x .028")

DO.739.300
Weingart



Distal end bending pliers
Kleszcze do zaginania końcówek dystalnych

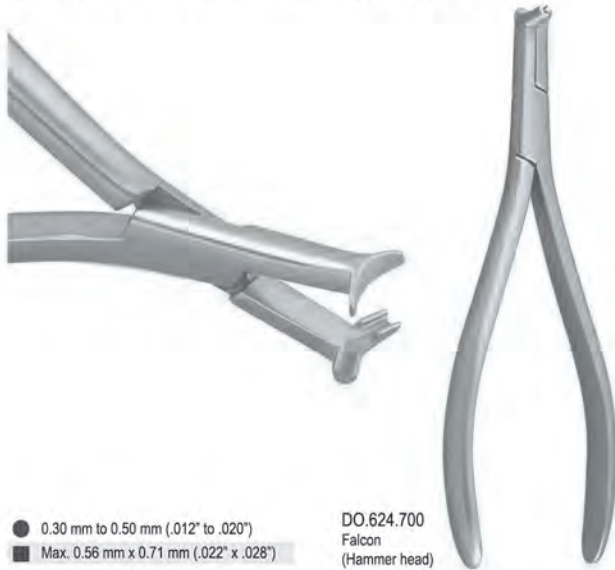

● 0.30 mm to 0.50 mm (.012" to .020")
■ Max. 0.56 mm x 0.71 mm (.022" x .028")

DO.624.700
Falcon
(Hammer head)

Multipurpose pliers
Kleszcze wielofunkcyjne

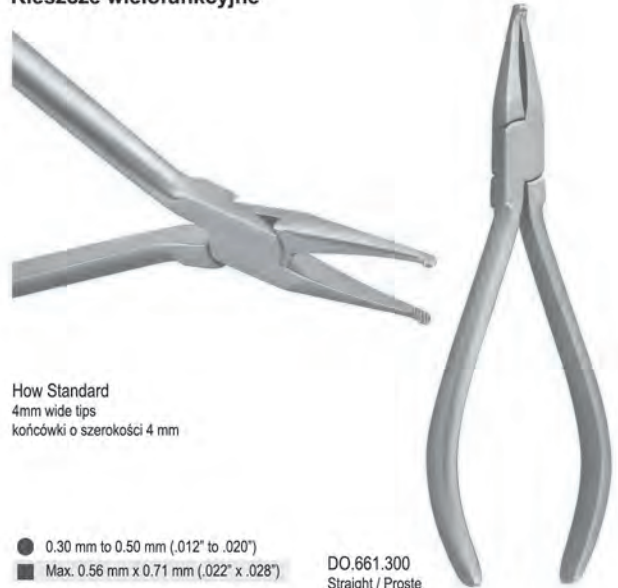

How Standard
4mm wide tips
końcówki o szerokości 4 mm

● 0.30 mm to 0.50 mm (.012" to .020")
■ Max. 0.56 mm x 0.71 mm (.022" x .028")

DO.661.300
Straight / Proste

Multipurpose pliers
Kleszcze wielofunkcyjne

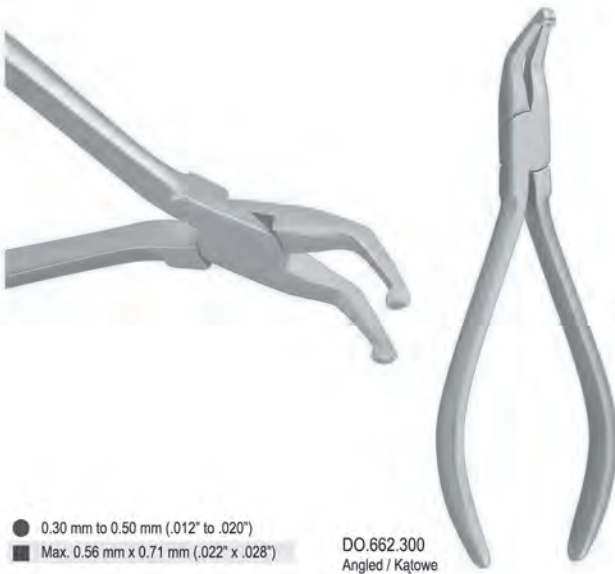

● 0.30 mm to 0.50 mm (.012" to .020")
■ Max. 0.56 mm x 0.71 mm (.022" x .028")

DO.662.300
Angled / Kątowe

Multipurpose pliers
Kleszcze wielofunkcyjne



How Mini
2.4 mm wide tips
końcówki o szerokości 2.4 mm

● 0.30 mm to 0.50 mm (.012" to .020")
■ Max. 0.56 mm x 0.71 mm (.022" x .028")

DO.664.300
Straight / Proste

Multipurpose pliers
Kleszcze wielofunkcyjne

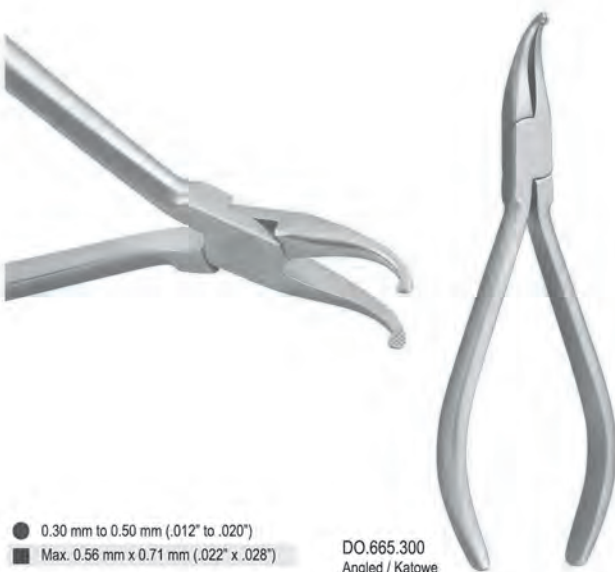

● 0.30 mm to 0.50 mm (.012" to .020")
■ Max. 0.56 mm x 0.71 mm (.022" x .028")

DO.665.300
Angled / Kątowe

Arch forming and contouring pliers
Kleszcze do formowania i konturowania łuków



● 0.36 mm to 0.50 mm (.012" to .020")
■ Max. 0.53 mm x 0.64 mm (.021" x .025")

DO.600.300
De la Rosa



Instruments for "Fixed Appliance Technique" Narzędzia do techniki aparatów stałych

Arch forming and contouring pliers Kleszcze do formowania i konturowania łuków

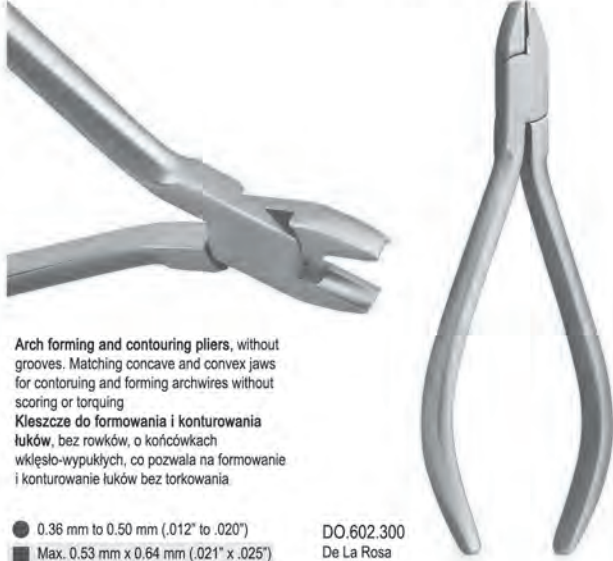

Arch forming and contouring pliers, without grooves. Matching concave and convex jaws for contouring and forming archwires without scoring or torquing
Kleszcze do formowania i konturowania łuków, bez rowków, o końcówkach wklęsło-wypukłych, co pozwala na formowanie i konturowanie łuków bez torkowania

● 0.36 mm to 0.50 mm (.012" to .020")
■ Max. 0.53 mm x 0.64 mm (.021" x .025")

DO.602.300
De La Rosa

Archwire forming pliers, concave and convex tips Kleszcze do formowania łuków z wklęsło-wypukłymi końcówkami

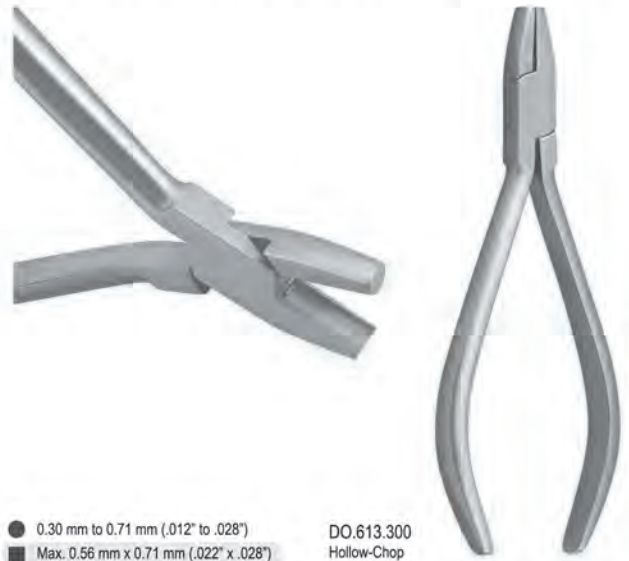

● 0.30 mm to 0.71 mm (.012" to .028")
■ Max. 0.56 mm x 0.71 mm (.022" x .028")

DO.613.300
Hollow-Chop

Light wire bending pliers Kleszcze do doginania drutu



Serrated tips and grooves assure accurate bending and closing of loops
Żłobione końcówki z rowkami dokładnie doginają drut i zamykają pętle.

● 0.30 mm to 0.50 mm (.012" to .020")
■ Max. 0.46 mm x 0.56 mm (.018" x .022")

DO.675.300
Jarabak

Loop forming pliers Kleszcze do formowania pętli

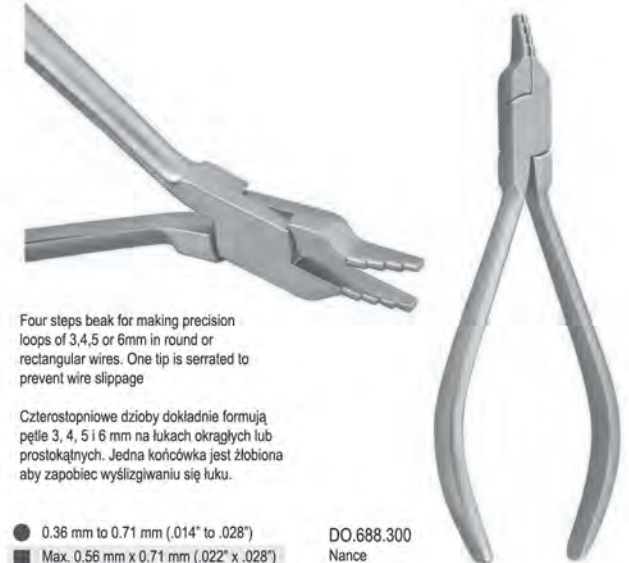

Four steps beak for making precision loops of 3,4,5 or 6mm in round or rectangular wires. One tip is serrated to prevent wire slippage
Czterostopniowe dzioby dokładnie formują pętle 3, 4, 5 i 6 mm na łukach okrągłych lub prostokątnych. Jedna końcówka jest żłobiona aby zapobiec wyslizgiwaniu się łuku.

● 0.36 mm to 0.71 mm (.014" to .028")
■ Max. 0.56 mm x 0.71 mm (.022" x .028")

DO.688.300
Nance

Loop forming pliers Kleszcze do formowania pętli



Serrated tips and grooves assure accurate bending and closing of loops
Żłobione końcówki z rowkami dokładnie doginają drut i zamykają pętle.

● 0.30 mm to 0.50 mm (.012" to .020")
■ Max. 0.46 mm x 0.56 mm (.018" x .022")

DO.705.300
Tweed

Loop forming pliers Kleszcze do formowania pętli



Four steps beak for making precision loops of 3,4,5 or 6mm in round or rectangular wires. One tip is serrated to prevent wire slippage
Czterostopniowe dzioby dokładnie formują pętle 3, 4, 5 i 6 mm na łukach okrągłych lub prostokątnych. Jedna końcówka jest żłobiona aby zapobiec wyslizgiwaniu się łuku.

● 0.36 mm to 0.71 mm (.014" to .028")
■ Max. 0.56 mm x 0.71 mm (.022" x .028")

DO.712.300
Tweed



Loop forming pliers
Kleszce do formowania pętli



Loop forming pliers with replaceable 440 stainless steel tip, three step tip has 1.14, 1.52 and 1.91mm diameters
Kleszce do formowania pętli z wymienną, trójstopniową końcówką (1.14 mm, 1.52 mm, 1.91 mm) ze stali nierdzewnej 440



DO.700.010
Replacement tip stainless steel 440
Wymienna trójstopniowa końcówka

- 0.36 mm to 0.50 mm (.012" to .020")
- Max. 0.53 mm x 0.64 mm (.021" x .025")

DO.710.200
Tweed



Arch forming pliers
Kleszce do formowania łuków

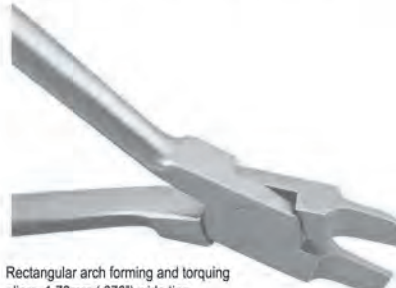

Rectangular arch forming and torquing pliers, 1.78mm (.070") wide tips

Kleszce do formowania łuków prostokątnych i nadawania toroku, szerokość końcówek 1.78mm (.070")

- Max. 0.30 mm to 0.71 mm (.012" to .028")
- Max. 0.56 mm x 0.71 mm (.022" x .028")

DO.713.300
Tweed / Angle



Pliers wire bending 3-jaw
Kleszce trójszczękowe do doginania drutu



Precision aligned and contoured tips for consistent bends without damaging the wire

Końcówki kleszczy są precyzyjnie wykończone, aby nie zniszczyć drutu podczas jego doginania.

- 0.36 mm to 0.76 mm (.014" to .030")
- Max. 0.56 mm x 0.71 mm (.022" x .028")

DO.585.300
Aderer



Lingual / Palatal arch forming pliers
Kleszce do formowania łuków językowych i podniebiennych



Rectangular arch forming and torquing pliers, 1.78mm (.070") wide tips

Kleszce do formowania łuków prostokątnych i nadawania toroku, szerokość końcówek 1.78mm (.070")

- 0.76 mm (.030") / 0.91 mm (.036")

DO.618.300
Falcon



Stop pliers V-Bend - 1mm
Kleszce do zagięć V - 1mm



- 0.30 mm to 0.50 mm (.012" to .020")
- Max. 0.43 mm x 0.56 mm (.017" x .022")

DO.655.700
Falcon



Detailing step pliers / Bayonet bending pliers - 1mm
Kleszce do formowania stopni 1mm



- 0.30 mm to 0.50 mm (.012" to .020")
- Max. 0.56 mm x 0.71 mm (.022" x .028")

DO.630.700
Falcon





Instruments for "Fixed Appliance Technique"
Narzędzia do techniki aparatów stałych

Torquing pliers set
Kleszce do torkowania, zestaw

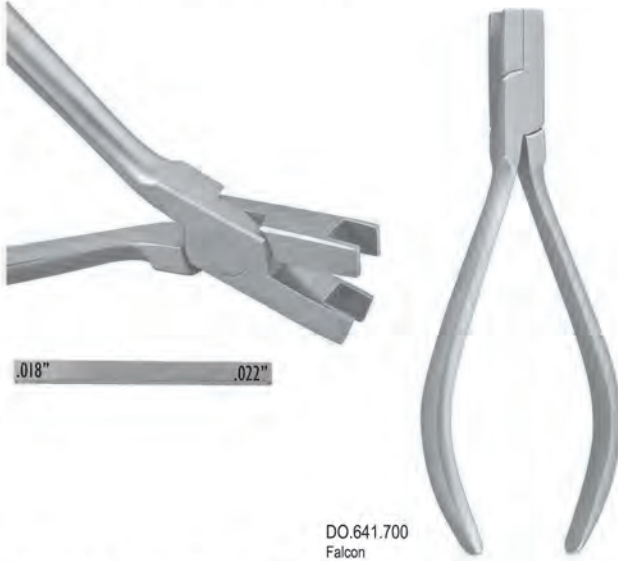

DO.641.700
 Falcon

Surgical ball hook crimping pliers
Kleszce do zaciskania haczyków



Used to crimp surgical ball hooks to archwire, slotted tip fits over the base of hook for secure hold while crimping, also can be used to crimp stops and posts. Long handles for easy access to posterior region
 Zaprojektowane aby w prosty sposób utrzymać haczyk oraz umieścić go na łuku. Dzięki jednemu ściśnięciu haczyk znajdzie się na łuku. Długie uchwyty ułatwiają dotarcie do miejsc trudnodostępnych.

DO.621.300
 Falcon
 Straight / Proste

Surgical ball hook crimping pliers
Kleszce do zaciskania haczyków



DO.620.300
 Falcon
 Angled / Kątowe

Aligner plier hole punch
Kleszce / Dziurkacz okrągły do aparatów retencyjnych



DO.750.010
 125mm

Aligner plier horizontal hole
Kleszce / Dziurkacz poziomy do aparatów retencyjnych



DO.750.020
 118mm



Aligner plier vertical hole
Kleszcze / Dziurkacz pionowy do aparatów retencyjnych



DO.750.030
118mm

Aligner plier tear drop hole
Kleszcze / Dziurkacz kształt łzy do aparatów retencyjnych



DO.750.040
118mm

Aligner plier hole punch
Kleszcze / Dziurkacz okrągły do aparatów retencyjnych



60-731
Hole punch
Dziurkacz okrągły
125mm

Aligner plier horizontal hole
Kleszcze / Dziurkacz poziomy do aparatów retencyjnych



60-732
Horizontal hole
Dziurkacz poziomy
118mm

Aligner plier vertical hole
Kleszcze / Dziurkacz pionowy do aparatów retencyjnych



60-733
Vertical hole
Dziurkacz pionowy
118mm

Aligner plier tear drop hole
Kleszcze / Dziurkacz kształt łzy do aparatów retencyjnych



60-734
Tear drop hole
Dziurkacz kształt łzy
118mm



Instruments for "Removable Appliance Technique" Narzędzia do techniki aparatów ruchomych

Hard wire cutters Kleszcze do cięcia twardego drutu



Hard wire cutters Kleszcze do cięcia twardego drutu



Universal wire bending and cutting pliers Kleszcze protetyczne kramponowe delfinki małe

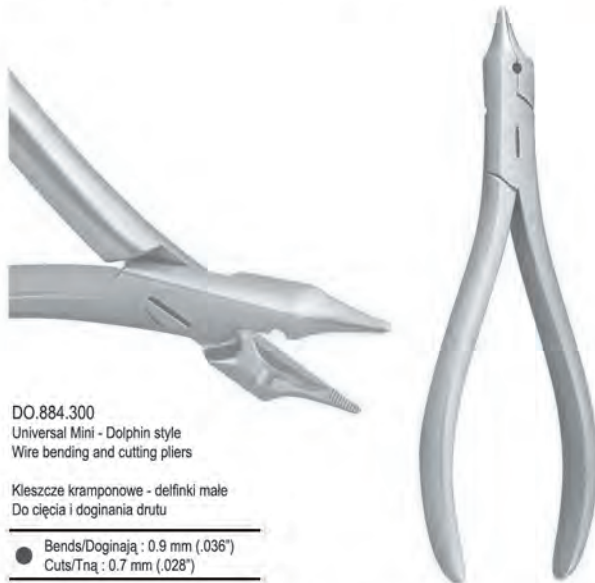

Universal wire bending and cutting pliers Kleszcze protetyczne kramponowe delfinki



Universal wire bending and cutting pliers Kleszcze protetyczne kramponowe zwykłe



Wire bending and cutting pliers Kleszcze do doginania i cięcia drutu



Instruments for "Removable Appliance Technique" Narzędzia do techniki aparatów ruchomych

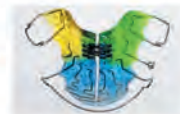

Pliers for facebow Kleszcze do łuków twarzowych

OW.553.180
180mm

Falcon-Cut wire cutter x-action angled
Kleszcze do cięcia drutu z przekładnią boczne

For hard wires up to 2.0 mm Ø, For soft wires up to 3 mm Ø
Tną twardy drut do 2,0 mm Ø i miękki do 3 mm Ø



Heavy duty hard wire cutters Kleszcze do cięcia twardego drutu



Falcon
Compound action
Cut heavy wires with little force
Tną twardy drut przy użyciu niewielkiej siły

DO.785.300
Small / Male
Stainless steel, autoclavable
Stal nierdzewna, możliwość sterylizacji w autoklawie
● 0.87 mm to 1.1 mm (.028" to .045")

Hard wire cutters Kleszcze do cięcia twardego drutu



Falcon
Compound action
Cut heavy wires with little force
Tną twardy drut przy użyciu niewielkiej siły

DO.786.300
Large / Duże
Stainless steel, autoclavable
Stal nierdzewna, możliwość sterylizacji w autoklawie
● 0.80 mm to 1.50 mm (.032" to .057")

Hard wire cutters Kleszcze do cięcia twardego drutu



Falcon
Compound action
Cut heavy wires with little force
Tną twardy drut przy użyciu niewielkiej siły

DO.787.300
Small / Male
Stainless steel, autoclavable
Stal nierdzewna, możliwość sterylizacji w autoklawie
● 0.87 mm to 1.1 mm (.028" to .045")

Pliers for facebow Kleszcze do łuków twarzowych



DO.888.300
Universal
Parallel jaw pliers with side cutter, compound action
Powerful pliers easily cuts outer bow of a facebow, serrated jaws assure non-slip grip while bending

Kleszcze do formowania i cięcia łuków twarzowych
Ząbkowane końcówki zapewniają pewny uchwyt łuku podczas formowania.

Max. 1.80 mm (.071")

Wire bending pliers Kleszcze do doginania drutu



Adams pliers with tungsten carbide tips
Kleszcze Adams z wkładką z węgla spiekane



Tips of all Adams pliers parallel at 1mm opening
box joint, available in mini and maxi sizes
Konstrukcja z zawiasami pudełkowymi, dostępne w dwóch rozmiarach: mini i maxi

DO.796.100
Adams Maxi Fig. 64
● 0.36 mm to 0.81 mm (.014" to .032")
■ Max. 0.56 mm x 0.71 mm (.022" x .028")





Instruments for "Removable Appliance Technique" Narzędzia do techniki aparatów ruchomych

Wire bending pliers Kleszce do doginania drutu



Adams pliers with tungsten carbide tips
Kleszce Adams z wkładką z węgla spiekanego



Tips of all Adams pliers parallel at 1mm opening box joint, available in mini and maxi sizes
Konstrukcja z zawiasami pudełkowymi, dostępne w dwóch rozmiarach: mini i maxi

DO.799.100
Adams Maxi Fig. 65

- 0.36 mm to 0.81 mm (.014" to .032")
- Max. 0.56 mm x 0.71 mm (.022" x .028")

Wire bending pliers Kleszce do doginania drutu



Tips of all Adams pliers parallel at 1mm opening box joint, available in mini and maxi sizes
Konstrukcja z zawiasami pudełkowymi, dostępne w dwóch rozmiarach: mini i maxi

DO.799.300
Adams Maxi Fig. 65

- 0.36 mm to 0.81 mm (.014" to .032")
- Max. 0.56 mm x 0.71 mm (.022" x .028")

Wire bending pliers Kleszce do doginania drutu

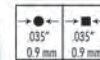

Tips of all Adams pliers parallel at 1mm opening box joint, available in mini and maxi sizes
Konstrukcja z zawiasami pudełkowymi, dostępne w dwóch rozmiarach: mini i maxi

DO.795.300
Adams Mini

- 0.36 mm to 0.81 mm (.014" to .032")
- Max. 0.56 mm x 0.71 mm (.022" x .028")

Wire bending pliers Kleszce do doginania drutu

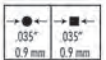

Tips of all Adams pliers parallel at 1mm opening box joint, available in mini and maxi sizes
Konstrukcja z zawiasami pudełkowymi, dostępne w dwóch rozmiarach: mini i maxi

DO.796.300
Adams Maxi Fig. 64

- 0.36 mm to 0.81 mm (.014" to .032")
- Max. 0.56 mm x 0.71 mm (.022" x .028")

Wire bending pliers Kleszce do doginania drutu

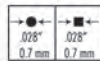

Tips of all Adams pliers parallel at 1mm opening box joint, available in mini and maxi sizes
Konstrukcja z zawiasami pudełkowymi, dostępne w dwóch rozmiarach: mini i maxi

DO.798.300
Adams Mini

- 0.36 mm to 0.81 mm (.014" to .032")
- Max. 0.56 mm x 0.71 mm (.022" x .028")

3-Jaw wire bending pliers Kleszce trójszczękowe do doginania drutu



Precision aligned and contoured tips for consistent bends without damaging wire.
Końcówki kleszczy są precyzyjnie wykończone, aby nie zniszczyć drutu podczas jego doginania.

DO.806.300
Aderer - Mini

- 0.36 mm to 0.50 mm (.014" to .020")
- Max. 0.53 mm x 0.64 mm (.021" x .025")

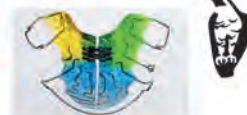

3-Jaw wire bending pliers
 Kleszcze trójszczękowe do doginania drutu



Precision aligned and contoured tips for consistent bends without damaging wire.
 Końcówki kleszczy są precyzyjnie wykończone, aby nie zniszczyć drutu podczas jego doginania.

DO.807.300
 Aderer - Midi

- 0.36 mm to 0.71 mm (.014" to .028")
- Max. 0.56 mm x 0.71 mm (.022" x .028")

3-Jaw wire bending pliers
 Kleszcze trójszczękowe do doginania drutu



Precision aligned and contoured tips for consistent bends without damaging wire.
 Końcówki kleszczy są precyzyjnie wykończone, aby nie zniszczyć drutu podczas jego doginania.

DO.808.300
 Aderer - Maxi

- 0.50 mm to 0.91 mm (.020" to .036")
- Max. 0.56 mm x 0.71 mm (.022" x .028")

Loop forming pliers
 Kleszcze do formowania pętli



Optical style, round and concave beaks.
 Końcówki kleszczy wklęsło-wypukłe.

DO.870.300
 Schwarz Mini

- Max. 0.50 mm (.020")

Loop forming pliers
 Kleszcze do formowania pętli



Optical style, round and concave beaks.
 Końcówki kleszczy wklęsło-wypukłe.

DO.871.300
 Schwarz Midi

- Max. 0.70 mm (.028")

Loop forming pliers
 Kleszcze do formowania pętli



Optical style, round and concave beaks.
 Końcówki kleszczy wklęsło-wypukłe.

DO.872.300
 Schwarz Maxi

- Max. 0.70 mm (.028")

Loop forming pliers
 Kleszcze do formowania pętli



Optical style, round and concave beaks.
 Końcówki kleszczy wklęsło-wypukłe.

DO.874.300
 Schwarz graduated / kalibrowane

- Max. 0.70 mm (.028")



Instruments for "Removable Appliance Technique"

Narzędzia do techniki aparatów ruchomych

Wire bending pliers Kleszcze do doginania drutu



Bird beak lab. pliers
Tips parallel at 1mm opening

Kleszcze protetyczne "ptasie dzioby"
Równoległe końcówki przy 1 mm rozwarciu

DO.812.300

Angle

- 0.36 mm to 0.81 mm (.014" to .032")
- Max. 0.56 mm x 0.71 mm (.022" x .028")

Flat nose wire bending pliers Kleszcze płaskie do doginania drutu



DO.830.300

Falcon

- 0.36 mm to 0.81 mm (.014" to .032")
- Max. 0.56 mm x 0.71 mm (.022" x .028")

Loop forming pliers Kleszcze do formowania pętli



DO.824.300

Falcon

- 0.36 mm to 0.71 mm (.014" to .028")
- Max. 0.56 mm x 0.71 mm (.022" x .028")

Wire bending pliers Kleszcze do doginania drutu



DO.838.300

Fisher

- 0.36 mm to 0.81 mm (.014" to .032")
- Max. 0.56 mm x 0.71 mm (.022" x .028")

Loop forming pliers Kleszcze do formowania pętli



Optical style, round and concave beaks.
Heavy loop forming pliers

Kleszcze wklęsło-wypukłe do formowania pętli

DO.850.300

Mckellops

- Max. 0.80 mm (.032")

Wire bending pliers Kleszcze do doginania drutu



DO.860.300

Peeso

- 0.36 mm to 0.71 mm (.014" to .028")
- Max. 0.56 mm x 0.71 mm (.022" x .028")

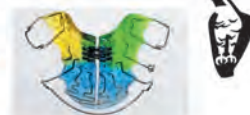

Crown and collar contouring pliers
Kleszce do konturowania koron i pierścieni



Crown and collar contouring pliers
Kleszce płasko-płaskie do konturowania koron i pierścieni

DO.861.300
Peeso

- 0.36 mm to 0.71 mm (.014" to .028")
- Max. 0.56 mm x 0.71 mm (.022" x .028")

Loop forming pliers
Kleszce do formowania pętli



DO.896.300
Young

- 0.36 mm to 0.71 mm (.014" to .028")
- Max. 0.56 mm x 0.71 mm (.022" x .028")

Arrow clasp bending pliers
Kleszce do przeginania klamer grotowych



DO.876.300
Schwarz

- Max. 0.70 mm (.028")

Arrow clasp forming pliers
Kleszce do formowania klamer grotowych



DO.877.300
Schwarz

- Max. 0.70 mm (.028")

Pliers for facebow
Kleszce do łuków twarzowych



Facebow loop forming pliers
For forming loops in either inner or outer bows of facebow

Kleszce do formowania łuków twarzowych
Do formowania pętli zewnętrznych i wewnętrznych na łuku

DO.810.300
Aderer

- Max. 1.60 mm (.063")

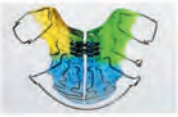

Instruments for "Removable Appliance Technique" Narzędzia do techniki aparatów ruchomych

Pliers stand / Stojak na kleszcze



DO.964.010



Upright pliers stands / Stojaki na kleszcze



DO.965.010 Black / Czarny



DO.965.040 Clear / Przezroczysty



DO.965.080 White / Biały



DO.965.020 Blue / Niebieski

Instruments organizer / Stojak na instrumenty



DO.966.030



DO.966.020

Pliers stands, autoclavable
Stojaki na kleszcze, możliwość sterylizacji w autoklawie



DO.964.030



DO.963.010
Mini



DO.963.020
Midi



DO.963.030
Maxi



DO.963.040
X-Large

Covered pliers rack
Stojak na kleszcze



DO.966.000

Occlusal and cheek retractor double ended
Rozwierak do policzków i ust



Autoclavable
Możliwość sterylizacji w autoklawie



DS.433.040

Intraoral photographic mirrors
Fotograficzne lusterka wewnątrzustne

Made of stainless steel
Wykonane ze stali nierdzewnej

 Autoclavable
Możliwość sterylizacji w autoklawie

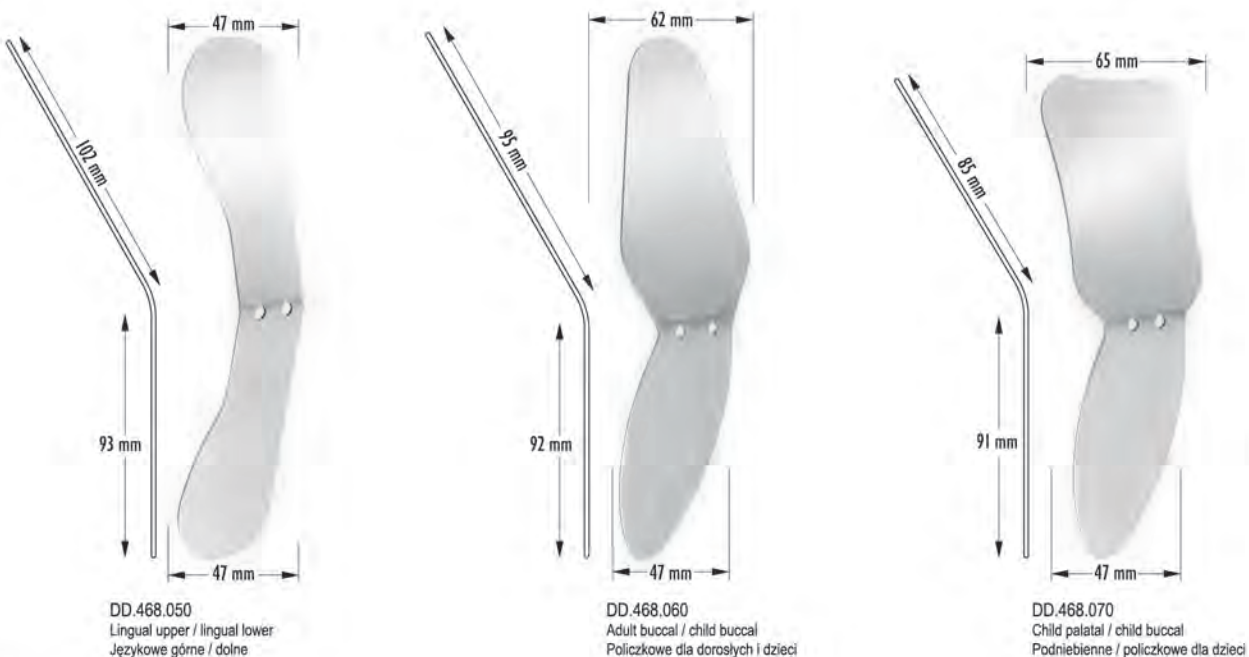
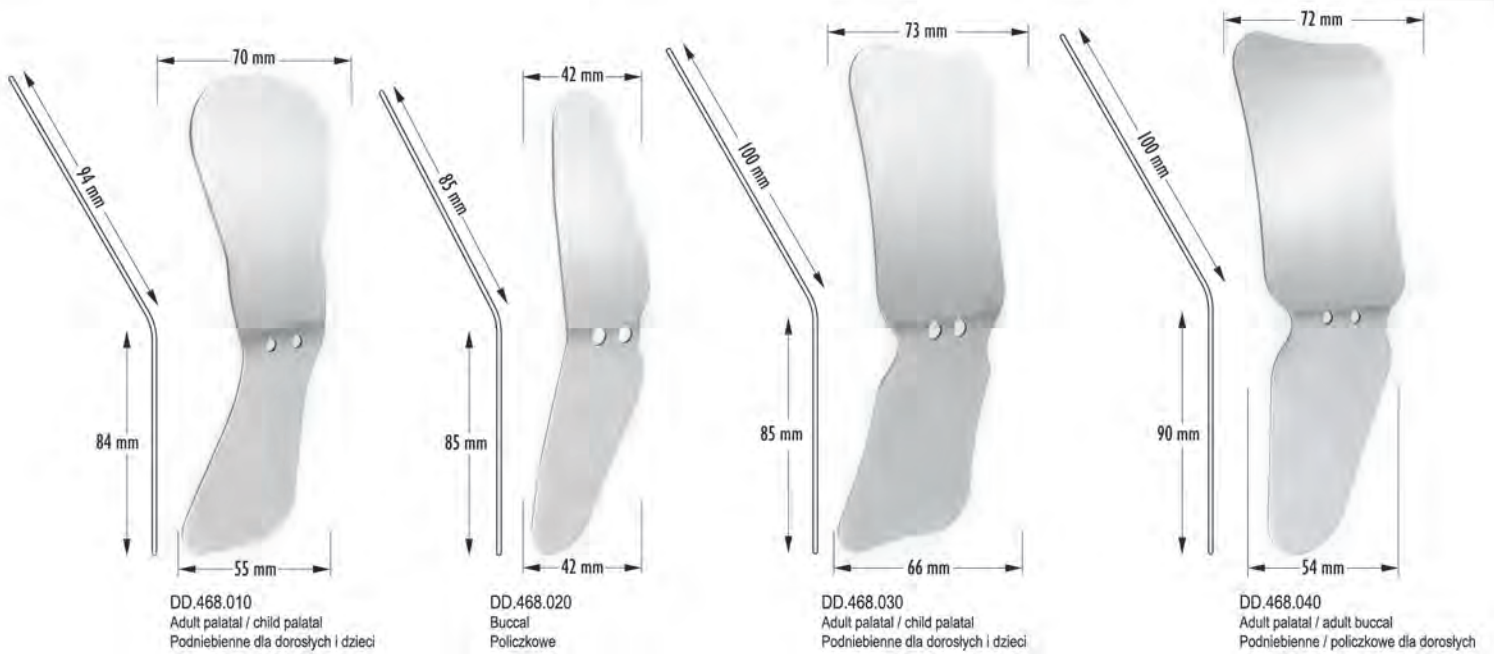

DD.468.000
Set of 7 mirrors
Zestaw zawiera 7 lusterek
1 x DD.468.010
1 x DD.468.020
1 x DD.468.030
1 x DD.468.040
1 x DD.468.050
1 x DD.468.060
1 x DD.468.070



Intraoral photographic mirrors
Fotograficzne lusterka wewnątrzustne



Double sided front surface
No double reflection
Chromium coated glass
Provides sharp images

Dwustronne, przedniopowierzchniowe
Brak efektu 'podwójnego odbicia'
Szkło, pokryte chromem
Zapewniają wyraźny obraz



Autoclavable
Możliwość sterylizacji w autoklawie

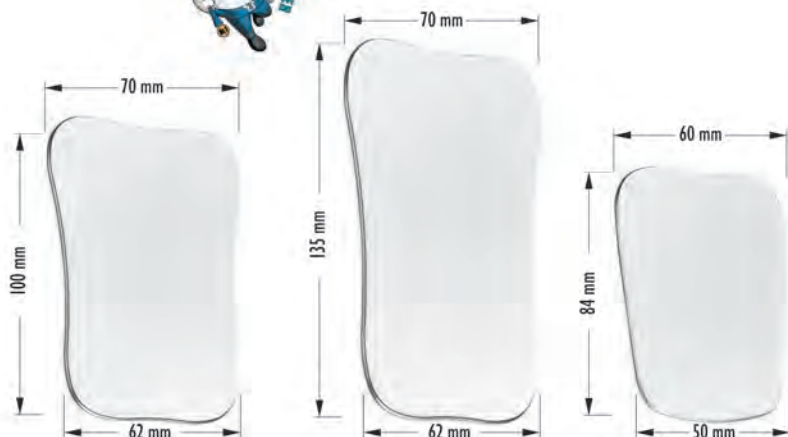

DD.470.030
Palatal-Adult
Podniebienne dla dorosłych

DD.470.031
Palatal-Adult Large
Podniebienne dla dorosłych - Duże

DD.470.040
Palatal-Child
Podniebienne dla dzieci

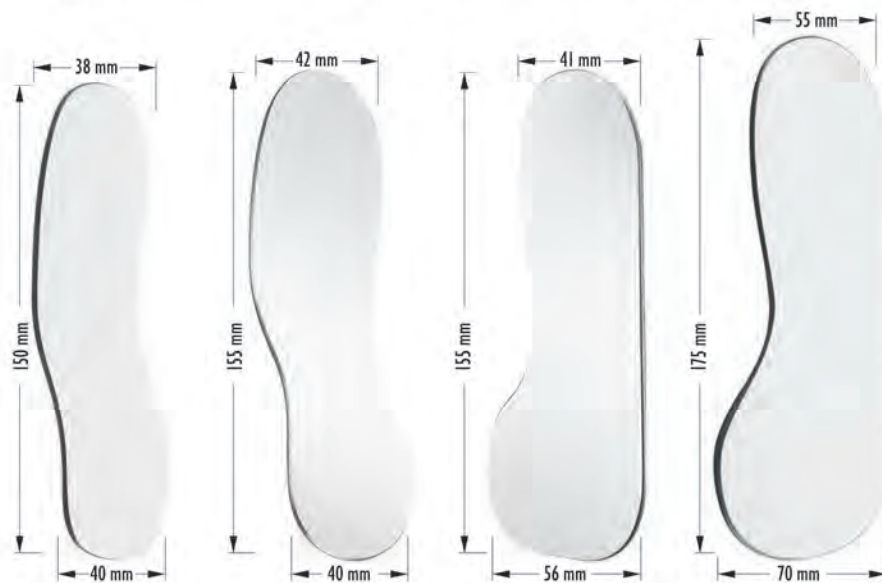

DD.470.011
Buccal - Small
Policzkowe-Male

DD.470.010
Buccal
Policzkowe

DD.470.020
Lingual
Językowe

DD.470.021
Lingual - Large
Językowe-Duże

DD.470.000

Set of 7 mirrors and 1 handle:
Zestaw zawiera 7 lusterek i 1 uchwyt:
1 x DD.470.010
1 x DD.470.011
1 x DD.470.020
1 x DD.470.021
1 x DD.470.030
1 x DD.470.031
1 x DD.470.040
1 x DD.472.000

Large mirrors with handle
Duże lusterka z uchwytem



For intraoral photography
Bendable at any angle
Chrome front surface
No double reflection
Autoclavable

Do zdjęć wewnątrzustnych
Wygina się pod każdym kątem
Pokryte chromem, przedniopowierzchniowe
Brak efektu 'podwójnego odbicia'
Możliwość sterylizacji w autoklawie

DD.471.010 Ø 38mm
DD.471.020 Ø 50mm

Sterilization cassette for photographic mirrors
Kaseta do sterylizacji lusterek fotograficznych



DZ.085.090

Suitable for all Intraoral photographic mirrors
Odpowiednia do wszystkich typów lusterek fotograficznych



Lips and cheek retractors
Rozwieraki do policzków i ust



Autoclavable
Możliwość sterylizacji w autoklawie

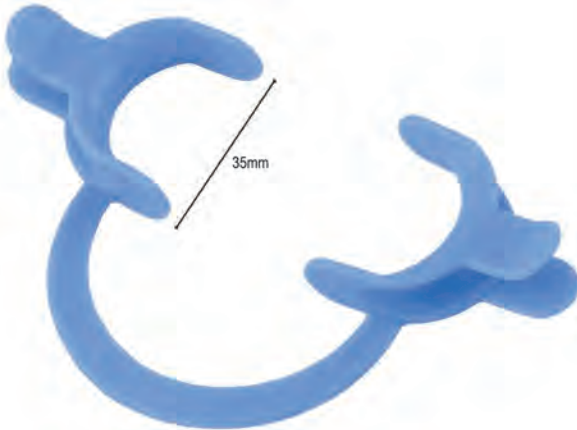

For child / Dla dzieci
DS.426.010

Lips and cheek retractors
Rozwieraki do policzków i ust



Autoclavable
Możliwość sterylizacji w autoklawie

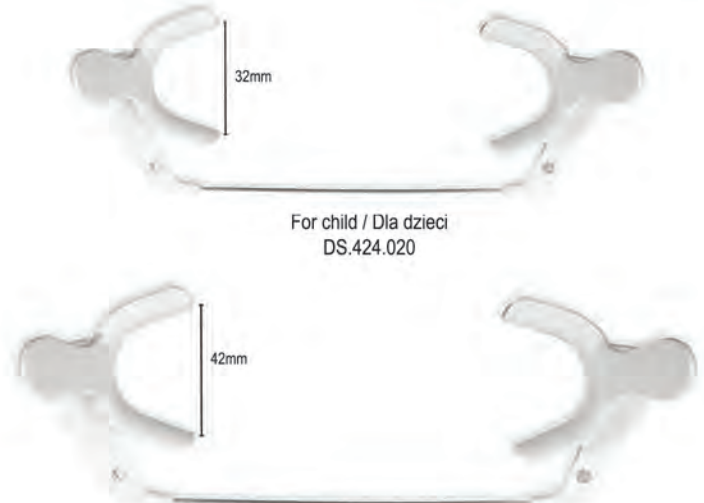

For child / Dla dzieci
DS.424.020

For adult / Dla dorosłych
DS.424.030

Lips and cheek retractor with tongue retainer
Rozwierak do policzków i ust z blokadą języka



Autoclavable
Możliwość sterylizacji w autoklawie



Small / Mały
DS.423.010



Medium / Średni
DS.423.020



Large / Duży
DS.423.030

Lips and cheek retractor with tongue retainer
Rozwierak do policzków i ust z blokadą języka



Autoclavable
Możliwość sterylizacji w autoklawie



Small / Mały
DS.423.060



Large / Duży
DS.423.070



Photo cheek retractors
Rozwieraki do zdjęć

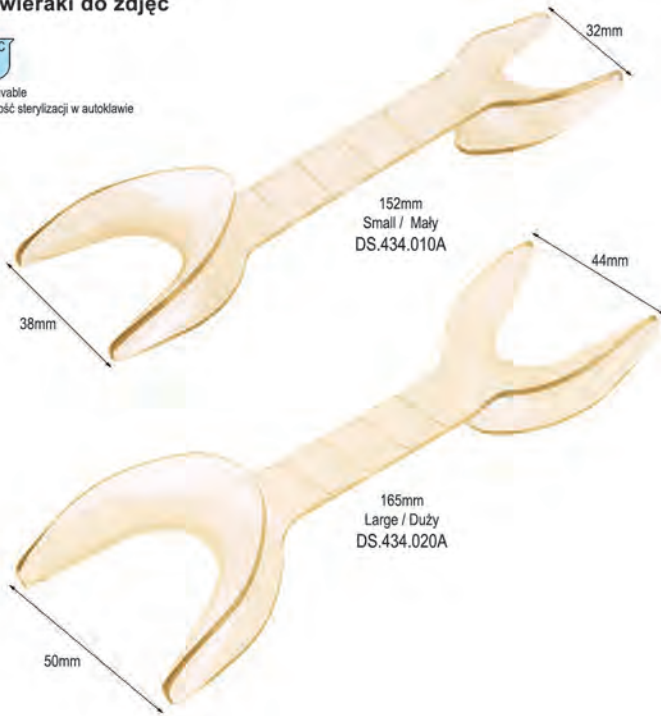

Photo cheek retractors
Rozwieraki do zdjęć



Photo cheek retractors (Autoclavable 135°C)
Rozwieraki do zdjęć (autoklawowalny 135°C)



Lips and cheek retractor with tongue retainer
Rozwierak do policzków i ust z blokadą języka



121° C
Autoclavable
Możliwość sterylizacji w autoklawie



Medium / Średni
DS.436.010

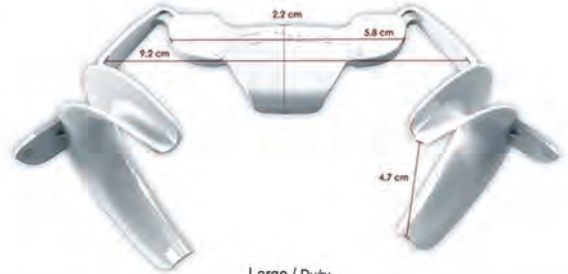

Large / Duży
DS.436.020

Extraoral retractors
Rozwierak zewnętrzne

Better access for the dentist to the teeth to perform clinical procedures, gives full view of anterior/posterior segment during direct bonding. Handles for easier insertion and for pulling the cheek anterior while bonding the side segment. Tension can be adjusted by using elastomers for maximum patient comfort, also keeps the upper and lower lip away from dry-field while bonding



135° C
Autoclavable
Możliwość sterylizacji w autoklawie

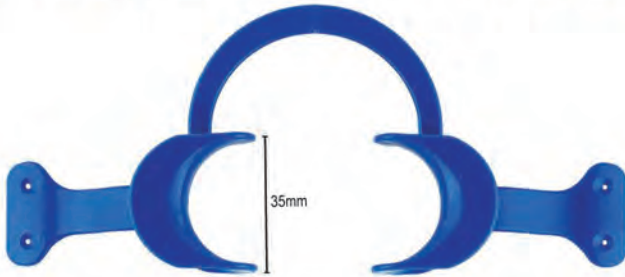

For child / Dla dzieci
DS.423.080

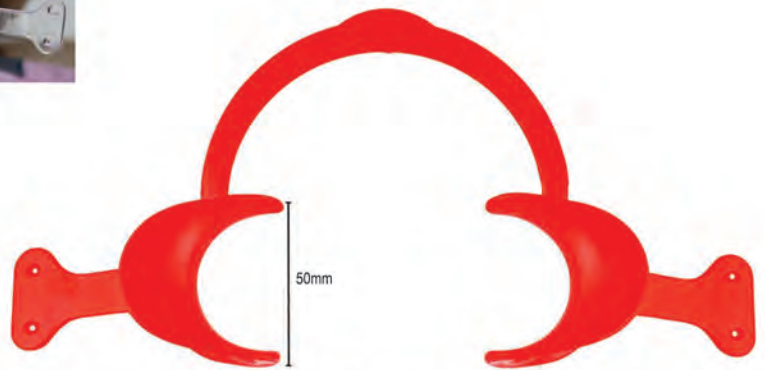

For adult / Dla dorosłych
DS.423.090

Nola - Dry Field System
System osuszający i rozwierający Nola

Designed for photographic retraction. Autoclave (121°C) or cold sterilization (glutaraldehyde only). Provides a totally dry field without cotton rolls. Comes with silicone tubing.



Complete set / Zestaw



DS.424.041 for child / dla dzieci
DS.424.051 for adult / dla dorosłych
Tongue guard with position block
2 pieces of silicone tube and Y - pipe



Code / Kod	Size / Rozmiar
DS.424.040	for child / dla dzieci
DS.424.050	for adult / dla dorosłych

Photo cheek and lip retractors
Rozwieraki policzkowe do ust i zdjęć



DS.435.010B
Simplex
105 mm



DS.435.000B
Simplex 1/2 CUT
105 mm
Pair (Left and Right)
Ends trimmed for easier occlusal view



DS.435.020B
Simplex-Falcon
110 mm



DS.435.030B
Simplex-Falcon
170 mm
V-Shape, excellent for
pulling back the cheek



DS.437.010B
Falcon
170 mm
Lip retractor, excellent
for occlusal photos



DS.435.010
Simplex
105 mm



DS.435.000
Simplex 1/2 CUT
105 mm
Pair (Left and Right)
Ends trimmed for easier occlusal view



DS.435.020
Simplex-Falcon
110 mm



DS.435.030
Simplex-Falcon
170 mm
V-Shape, excellent for
pulling back the cheek



DS.437.010
Falcon
170 mm
Lip retractor, excellent
for occlusal photos

Photography Lip retractor
Rozwierak wargowy do zdjęć



 Autoclavable
Możliwość sterylizacji w autoklawie

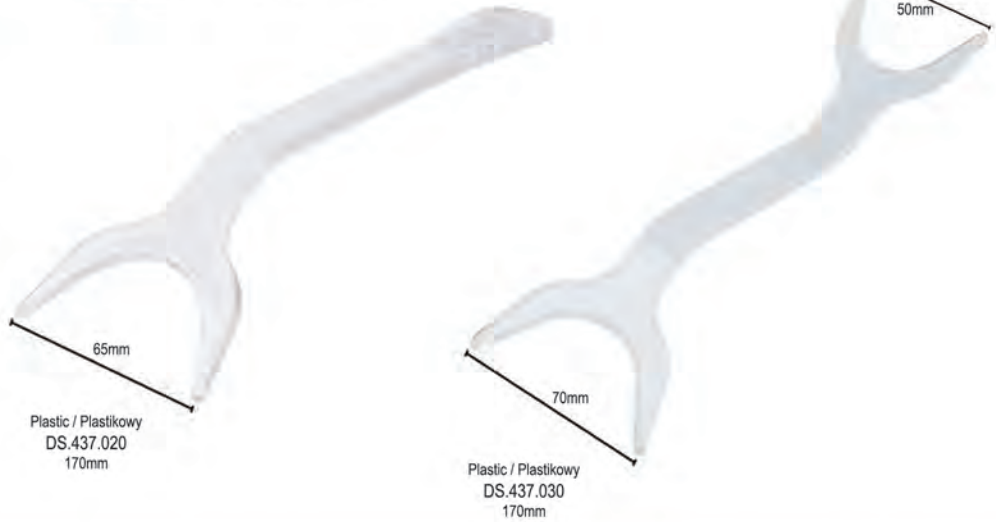

Soft retractor lips and cheek
Rozwierak do policzków i ust miękkie

 Cold sterilization only
Sterylizacja na zimno

 Autoclavable
Możliwość sterylizacji w autoklawie

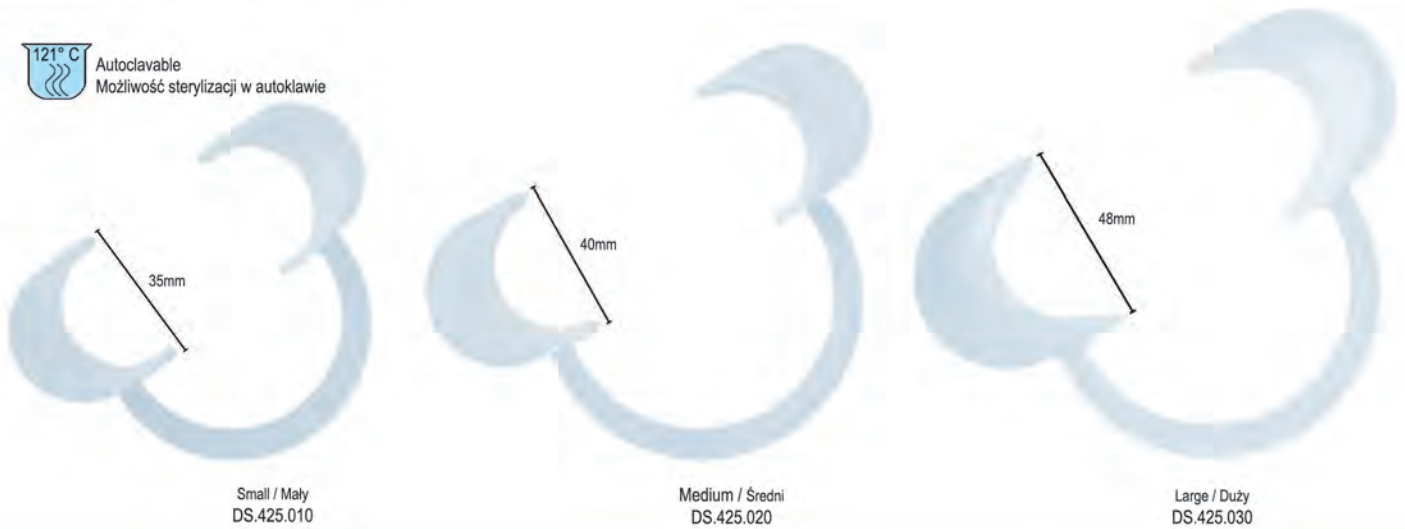

Transparent retractors
Rozwieraki przezroczyste

 Autoclavable
Możliwość sterylizacji w autoklawie



Lips retractors
Rozwieraki do warg



Autoclavable
Możliwość sterylizacji w autoklawie



Small / Mały
DS.422.010

Large / Duży
DS.422.020

Bite registration wafers
Wafle do rejestracji zgryzu



Pack of 10 pieces
Opak. 10 szt.

DI.003.000

Provides clear impression of teeth
Zapewniają wyraźną rejestrację zgryzu

Handle for photographic mirrors
Uchwyt do lusterka fotograficznego



DD.472.000
Stainless Steel
Stal nierdzewna

DD.472.010
Silver

DD.472.020
Black

DD.472.030
Green

DD.472.040
Pink

Impression protector
Pasek ochronny na zamki ortodontyczne



DI.015.000

Pack of 10 pairs / Opak. 10 par

Allows to take good impression while patient is wearing braces
by preventing alginate adhering to brackets.

Pozwala uzyskać prawidłowy wycisk podczas noszenia aparatu stałego,
zapobiega przyklejaniu masy do zamków

Plastic model bases
Jednorazowa plastikowa forma do modeli kontrolnych



Complete upper and
lower with hinges
Komplet górny i dolny z
zawiasami

Standard / Standard DL.090.010

Large / Duża DL.090.020

Rubber model bases
Gumowa forma do modeli



Set of 6 pieces, assorted sizes,
upper and lower
Zestaw 6 szt., różne rozmiary,
górne i dolne

DL.091.010

Disposable tongue blocks with saliva ejectors
Jednorazowe blokady języka ze ślinociągiem

Helps maintain a dry field / Pomagają utrzymać suchą powierzchnię
Enable patient to relax jaw / Zapewniają odpoczynek szczękom pacjenta



Tongue blocks
Blokada języka

Saliva ejectors
Ślinociąg

Adapter tubes
Złączka do ślinociągu

DZ.5000.01 Small / Mała
DZ.5000.02 Medium / Średnia
Pack of 50 pieces
Opak. 50 szt.

DZ.5003.00
Pack of 3 pieces
Opak. 3 szt.

DZ.5004.00
Pack of 3 pieces
Opak. 3 szt.

Pro-Lock Disposable orthodontic impression trays
Pro-Lock Jednorazowe Ortodontyczne łyżki wyciskowe

Pack includes 10 trays of 1 size
Opak.zawiera 10 łyżek z 1 rozmiaru



Fig.1
DI.036.010
Upper XXS
Górna XXS



Fig.2
DI.036.020
Upper XS
Górna XS



Fig.3
DI.036.030
Upper S
Górna S



Fig.4
DI.036.040
Upper M
Górna M



Fig.5
DI.036.050
Upper L
Górna L



Fig.6
DI.036.060
Upper XL
Górna XL



Fig.1
DI.035.010
Lower XXS
Dolna XXS



Fig.2
DI.035.020
Lower XS
Dolna XS



Fig.3
DI.035.030
Lower S
Dolna S



Fig.4
DI.035.040
Lower M
Dolna M



Fig.5
DI.035.050
Lower L
Dolna L



Fig.6
DI.035.060
Lower XL
Dolna XL

Tuff-Lock Disposable orthodontic impression trays
Tuff-Lock Jednorazowe Ortodontyczne łyżki wyciskowe

Pack includes 10 trays of 1 size
Opak.zawiera 10 łyżek z 1 rozmiaru



Fig.5
DI.038.050
Upper XS
Górna XS



Fig.4
DI.038.040
Upper S
Górna S



Fig.3
DI.038.030
Upper M
Górna M



Fig.2
DI.038.020
Upper L
Górna L



Fig.1
DI.038.010
Upper L
Górna L



Fig.5
DI.037.050
Lower XS
Dolna XS



Fig.4
DI.037.040
Lower S
Dolna S



Fig.3
DI.037.030
Lower M
Dolna M

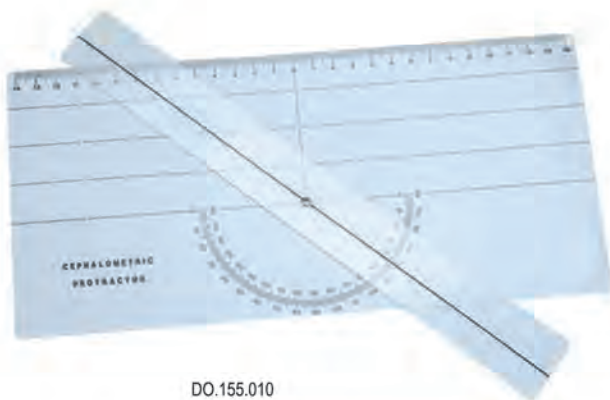

Fig.2
DI.037.020
Lower L
Dolna L



Fig.1
DI.037.010
Lower XL
Dolna XL

Template cephalometric / Szablon cefalometryczny



DO.155.010

Cephalometric protractor and tracing template
Kątomierz cefalometryczny i szablon ortodontyczny

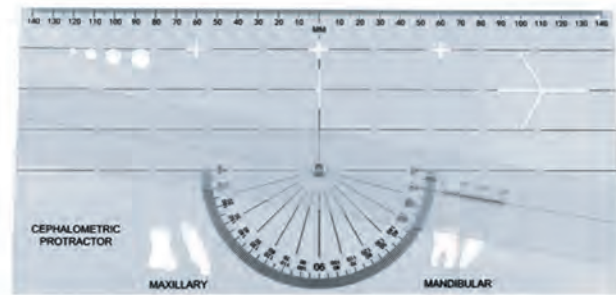

DO.155.011

Template tracing / Szablon ortodontyczny

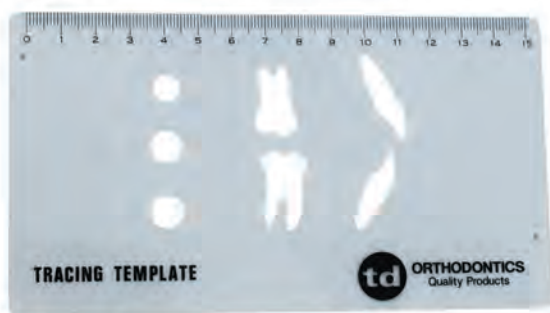

DO.155.020

Cephalometric triangle
Szablon cefalometryczny trójkąt

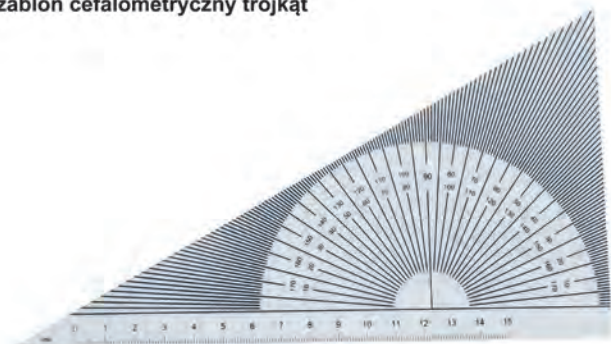

DO.155.070

Template correlometer / Korelometr

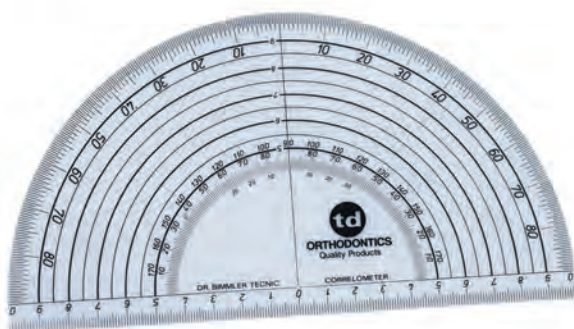

DO.155.030

Template Ricketts / Szablon Ricketta

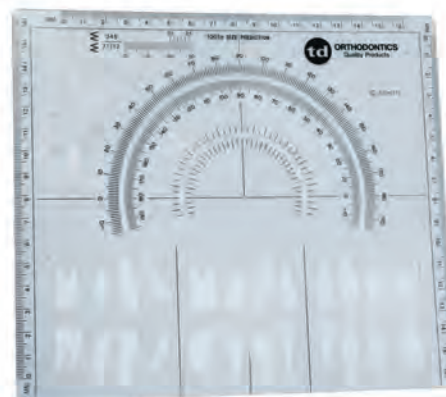

DO.155.040

Cephalometric tracing film
Kalka cefalometryczna



DO.156.100
8" x 10" (200 mm x 250 mm)
100 sheets / 100 kartek

Tracing pencils
Ołówki do zaznaczania



DO.156.010 Black / Czarne
DO.156.020 Blue / Niebieskie
DO.156.030 Red / Czerwone
DO.156.040 Green / Zielone
DO.156.050 White / Białe
DO.156.060 Yellow / Żółte

D₁₅

Teaching Aids / Pomocze dydaktyczne





Real-Series Dental Models

Dental models ideal occlusion, adult jaw

- Rigid bases - 32 fixed teeth - Articulated
- Available with transparent or pink bases, life or big size
- Advantage in transparent models is visibility of roots

Modele stomatologiczne, zgryz idealny, szczęka dorosłego

- Bazy twarde z zawiasami - 32 zęby osadzone na stałe
- Dostępne bazy przezroczyste lub różowe oraz modele duże lub wielkości naturalnej
- Zaletą w modelach przezroczystych jest możliwość zobaczenia korzeni

Life size / Wielkość naturalna



Big size / Model duży



Transparent / Przezroczyste

Models are shown 1/1 - Zdjęcia modeli w skali 1/1

Fig.	Size / Rozmiar	Code / Kod
RV-006	Life size / Wielkość naturalna	DT.1201.01
RV-001	Big size / Model duży	DT.1201.02

Two Tones, pink bases / Bazy różowe w dwóch odcieniach

Fig.	Size / Rozmiar	Code / Kod
RV-007	Life size / Wielkość naturalna	DT.1200.01
RV-002	Big size / Model duży	DT.1200.02

Dental models ideal occlusion, adult jaw ramified / Modele stomatologiczne, zgryz idealny, szczęka dorosłego z przypadkami klinicznymi

- Detailed model to explain different diseases and treatments
- Rigid bases - 32 fixed teeth - Articulated
- Shows caries (decayed teeth are removable)
- Shows healthy and decayed pulp canal
- Fitted with implant and crown
- Szczegółowy model pomocny przy objaśnianiu różnych chorób oraz sposobów ich leczenia
- Bazy twarde z zawiasami - 32 zęby osadzone na stałe
- Pokazuje zmiany próchnicze (możliwość wyjęcia zębów z ubytkami)
- Pokazuje zdrowe kanały zębów oraz zapalenie miazgi
- Zawiera implant oraz koronę

Big size / Model duży



Fig. RV-009

Life size / Wielkość naturalna

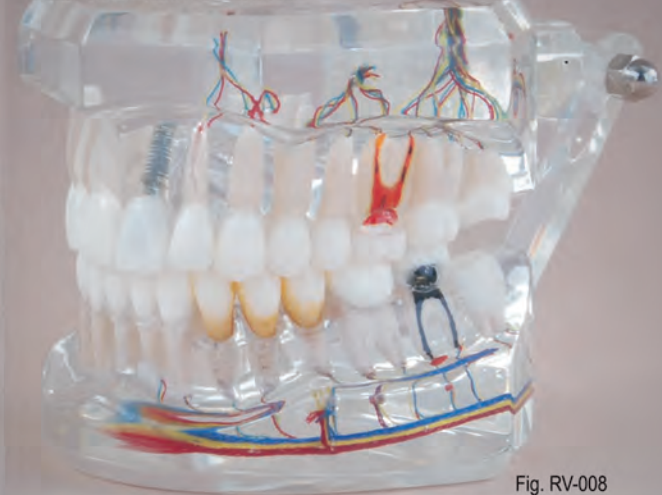

Fig. RV-008

Transparent / Przezroczyste

Fig.	Size / Rozmiar	Code / Kod
RV-008	Life size / Wielkość naturalna	DT.1205.01
RV-009	Big size / Model duży	DT.1205.02

Real-Series Dental Models

Model demonstrujący różne etapy próchnicy
Zawiera zestaw 4 zębów ze zmianami próchnicznymi



Fig. RV-003 DT.1220.00 Set of 4 teeth with holder / Zestaw 4 zębów ze stojakiem

Model demonstrujący stany patologiczne przyzębia
Zestaw 4 modeli pokazujący rozwój choroby periodontologicznej



Fig. RV-004 DT.1225.00 Set of 4 models / Zestaw 4 modeli

Dental model ideal occlusion, adult jaw

- Flexible bases - 32 teeth with roots - Non-articulated
- Versatile model to demonstrate many dental treatment techniques
- Removable teeth allow fitting of different dental appliances e.g implants, crowns
- Allows demonstration of extraction instruments and practice of extraction techniques
- Superior alternative to wax base models

Model stomatologiczny, zgryz idealny, szczęka dorosłego

- Bazy elastyczne bez zawiasów - 32 zęby ruchome z korzeniami
- Model uniwersalny do demonstracji różnych metod leczenia stomatologicznego
- Ruchome zęby pozwalają na umieszczenie np. implantów lub koron
- Możliwość pokazania technik w ekstrakcji oraz sposobu użycia instrumentów ekstrakcyjnych
- Lepsza alternatywa dla modeli z bazami woskowymi



Fig. RV-010 DT.1210.00
Set of 2, upper and lower Zestaw szczęki i żuchwy

Real-Series Endodontic Models

Endodontic practice model

- With canal cavities in FDI 11 to 16 and 41 to 46, indicated by silver lines on model
- Very useful model for practicing use of root canal instruments
- Rigid bases - 32 fixed teeth with roots - Articulated

Model endodontyczny

- Z otworami w kanałach (FDI 11 do 16 i 41 do 46), oznaczonymi srebrnymi liniami na modelu
- Możliwość pokazania sposobu użycia instrumentów do leczenia kanałowego
- Bazy twarde z zawiasami - 32 zęby osadzone na stałe z korzeniami

Demonstration Model - Ramified

- Detailed model to explain Endodontic problems and treatments
- Shows caries (decayed teeth are removable)
- Shows healthy and decayed pulp canal
- Rigid bases - 32 fixed teeth with roots - Articulated

Model pokazowy z przypadkami klinicznymi

- Szczegółowy model pomocny przy objaśnianiu problemów endodontycznych oraz sposobów ich leczenia
- Pokazuje zmiany próchnicze (możliwość wyjęcia zębów z ubytkami)
- Pokazuje zdrowe kanały zębów oraz zapalenie miazgi
- Bazy twarde z zawiasami - 32 zęby z korzeniami



Fig. RE-110 DT.1250.00



Fig. RE-111 DT.1251.00



Real-Series Surgery Models

Surgery model ideal occlusion, adult jaw

- Complete Maxilla and Mandible bone structure with sinus cavity
- Moveable and removable mandible
- Rigid bases - 32 fixed teeth - Articulated with stand

Model chirurgiczny, zgryz idealny, szczęka dorosłego

- Struktura kostna szczęki i żuchwy z zatoką szczękową
- Żuchwa ruchoma z możliwością wyjęcia
- Bazy twarde z zawiasami na stojaku - 32 zęby osadzone na stałe



Fig. RC-251
DT.1275.00

Skull model, adult size

- Removable cranial cap
- Moveable and removable mandible

Model czaszki dorosłego

- Możliwość zdjęcia mózgowiczaszki
- Żuchwa ruchoma z możliwością wyjęcia



Fig. RC-252
DT.1285.00

Surgery model ideal occlusion, adult jaw ramified / Model chirurgiczny, zgryz idealny, szczęka dorosłego z przypadkami klinicznymi

- Complete Maxilla and Mandible bone structure with sinus cavity
- Detailed model to explain different diseases and treatments
- Moveable and removable mandible
- Rigid bases - 32 fixed teeth - Articulated with stand
- Shows caries (decayed teeth are removable)
- Shows healthy and decayed pulp canal

- Struktura kostna szczęki i żuchwy z zatoką szczękową
- Szczegółowy model pomocny przy objaśnianiu różnych chorób oraz sposobów ich leczenia
- Żuchwa ruchoma z możliwością wyjęcia
- Bazy twarde z zawiasami na stojaku - 32 zęby osadzone na stałe
- Pokazuje zmiany próchnicze (możliwość wyjęcia zębów z ubytkami)
- Pokazuje zdrowe kanały zębów oraz zapalenie miążgi



Fig. RC-250
DT.1276.00



Real-Series Orthodontic Models

Transparent / Przezroczyste

Two Tones, pink bases / Bazy różowe w dwóch odcieniach

Rigid bases - 28 fixed teeth - Articulated

Available in transparent or pink bases

Bazy twarde z zawiasami - 28 zębów osadzonych na stałe

Dostępne bazy przezroczyste lub różowe

Class I - Ideal arch / Klasa I - Zgryz idealny



Fig. RO-040

DT.1305.01 Transparent / Przezroczysty

Class I - Ideal arch / Klasa I - Zgryz idealny



Fig. RO-048

DT.1300.01 Two Tones, pink bases / Bazy różowe w dwóch odcieniach

Class I - 'Angle / Klasa I wg Angle'a



Fig.	Type / Model	Code / Kod
RO-053	Two Tones, pink bases / Bazy różowe w dwóch odcieniach	DT.1303.02
RO-045	Transparent / Przezroczysty	DT.1305.02

Class II Division I / Klasa II wg Angle'a wersja I



Fig.	Type / Model	Code / Kod
RO-049	Two Tones, pink bases / Bazy różowe w dwóch odcieniach	DT.1303.03
RO-041	Transparent / Przezroczysty	DT.1305.03

Class II Division II / Klasa II wg Angle'a wersja II



Fig.	Type / Model	Code / Kod
RO-050	Two Tones, pink bases / Bazy różowe w dwóch odcieniach	DT.1303.04
RO-042	Transparent / Przezroczysty	DT.1305.04

Class III / Klasa III wg Angle'a



Fig.	Type / Model	Code / Kod
RO-051	Two Tones, pink bases / Bazy różowe w dwóch odcieniach	DT.1303.05
RO-043	Transparent / Przezroczysty	DT.1305.05



Real-Series Orthodontic Models

Desk-Top patient education models

- Ideal for the desk of orthodontists, for explanation of treatment to patients
- Fitted with brackets, wires, ligatures and buccal tubes
- Other devices can also be added i.e. temporary implants
- Model with ceramic and metal brackets to demonstrate the difference

Modele ortodontyczne, dydaktyczne (na biurko)

- Doskonale do pokazania i wytłumaczenia pacjentom przebiegu leczenia ortodontycznego
- Zawierają zamki, luki, ligatury i rurki policzkowe
- Można założyć inne akcesoria ortodontyczne tj. implanty tymczasowe
- Model z zamkami metalowymi i ceramicznymi pokazuje różnice między obydwoimi rodzajami zamków



DT.1320.01 With metal brackets / z metalowymi zamkami
DT.1320.02 With ceramic and metal brackets / z metalowymi i ceramicznymi zamkami

Model ortodontyczny, zgryz idealny, bazy elastyczne bez zawiasów

- 28 ruchomych zębów
- Uniwersalny model do demonstracji wielu technik leczenia ortodontycznego z możliwością użycia tymczasowych implantów



DT.1315.01 Teeth without roots
Zęby bez korzeni

DT.1315.02 Teeth with roots
Zęby z korzeniami

Orthodontic model, Ideal occlusion, Rigid bases

- Removable 28 teeth, Non-articulated

Model ortodontyczny, zgryz idealny, bazy twarde bez zawiasów

- 28 ruchomych zębów



DT.1316.01 Teeth without roots
Zęby bez korzeni

DT.1316.02 Teeth with roots
Zęby z korzeniami

Wax bases for typodont / Bazy woskowe do typodontu



DT.1401.01 Class I
Pair / Para Klasa I wg Angle'a
DT.1401.02 Class II Division I
Pair / Para Klasa II wg Angle'a wersja I
DT.1401.03 Class II Division II
Pair / Para Klasa II wg Angle'a wersja II
DT.1401.04 Class III
Pair / Para Klasa III wg Angle'a

Typodonts

Typodont Articulator is an excellent demonstration and teaching aid. Articulation allows for a magnitude of adjustments to emulate a variety of malocclusions and skeletal discrepancies. Metal or plastic teeth seat in wax bases for simulation using various orthodontic appliances.

The teeth movement can be demonstrated by fitting required orthodontic appliances and placing typodont in hot water or oven for 30 to 60 minutes at 60 °C (140 °F).

Typodonty

Typodonty są bardzo dobrą pomocą dydaktyczną obrazującą różnego typu wady zgryzu oraz nieprawidłowości w budowie kostnej. Metalowe lub plastikowe zęby umieszczone w bazy woskowej pozwalają na różnorakie ich ustawienie. Przemieszczanie zębów można zademonstrować poprzez ustawienie ich w wybranej bazy woskowej i zanurzenie w gorącej wodzie od 30 do 60 min. w temperaturze 60°C (140°F).



DT.1400.01 Metal typodont /
Typodont metalowy



DT.1400.02 Plastic typodont /
Typodont plastikowy

Sets of teeth for typodont / Zestawy zębów do typodontu

Plastic teeth with screws / Zęby plastikowe bez korzeni ze śrubami



DT.1403.02 Set of 32 teeth with roots / Zestaw 32 zębów z korzeniami

Sets of teeth for typodont / Zestawy zębów do typodontu

Plastic teeth / Zęby plastikowe



DT.1403.03 Set of 28 teeth with roots / Zestaw 28 zębów z korzeniami
Metal teeth / Zęby metalowe



DT.1403.01 Set of 28 teeth without roots / Zestaw 28 zębów bez korzeni

Real-Series Pedodontics Models

Series of models show transition from Deciduous to Permanent dentition
Transparent Rigid bases - Fixed teeth with roots - Articulated
Seria modeli pokazujących przejście od uzębienia mlecznego do uzębienia stałego
Bazy twarde przezroczyste z zawiasami - zęby osadzone na stałe z korzeniami

Pedodontic model, Five years old
Deciduous teeth with embryos, Shows healthy pulp canal

Model pedodontyczny, wiek 5 lat
Uzębienie mleczne z ząbkami, zdrowa miazga



Fig. RD-021

DT.1180.01 Transparent / Przezroczysty

Pedodontic model, Seven years old
Mixed dentition, Shows healthy pulp canal

Model pedodontyczny, wiek 7 lat
Uzębienie mieszane, zdrowa miazga



Fig. RD-022

DT.1180.02 Transparent / Przezroczysty

Pedodontic model, Ten years old
Mixed dentition, Shows healthy pulp canal

Model pedodontyczny, wiek 10 lat
Uzębienie mieszane, zdrowa miazga



Fig. RD-023

DT.1180.03 Transparent / Przezroczysty

Pedodontic model, Eleven years old
Permanent dentition

Model pedodontyczny, wiek 11 lat
Uzębienie stałe



Fig. RD-024

DT.1180.04 Transparent / Przezroczysty

Pedodontic model, Twelve years old
Permanent dentition with windows

Model pedodontyczny, wiek 12 lat
Uzębienie stałe z brakami



Fig. RD-025

DT.1180.05 Transparent / Przezroczysty

Pedodontic model, Twelve years old
Permanent dentition without windows

Model pedodontyczny, wiek 12 lat
Uzębienie stałe bez braków



Fig. RD-026

DT.1180.06 Transparent / Przezroczysty



Real-Series Pedodontics Models

Combination model 'Five-Ten'

Deciduous teeth of five years old on right side and of ten years old on left
Teeth with roots - Healthy pulp canals - Rigid bases - Articulated

Model pedodontyczny wiek 5 lat / wiek 10 lat

Prawa strona modelu przedstawia zęby mleczne 5 latka, lewa strona zęby 10 latka
Zęby z korzeniami - zdrowa miazga - bazy twarde z zawiasami



Fig. RD-028

DT.1180.08 Transparent / Przezroczysty

Combination model 'Five-Adult'

Deciduous teeth of five years old on right side and Permanent Dentition on left
Teeth with roots - Healthy pulp canals - Rigid bases - Articulated

Model pedodontyczny wiek 5 lat / dorosły

Prawa strona modelu przedstawia zęby mleczne 5 latka, lewa strona stałe uzębienie dorosłego. Zęby z korzeniami - zdrowa miazga - bazy twarde z zawiasami



Fig. RD-027

DT.1180.07 Transparent / Przezroczysty

Natural Deciduous Teeth Storage Model

Interesting way to store fallen Deciduous teeth
Teeth can be fitted with glue

Model do przechowywania zębów mlecznych

Interesujący sposób przechowywania zębów mlecznych
Zęby można włożyć i przykleić w modelu



Fig. RD-029

DT.1185.00 Transparent / Przezroczysty

Model's display and storage box with cover

Pudełko do przechowywania modeli z przykrywką

Big toothbrush

for demonstration of brushing technique

Szczotka do zębów duża

do demonstracji technik szczotkowania



DT.9990.01 Empty / Bez modeli



DT.9995.01 35 cm long / długość 35 cm

STAR SMILEZ®

SMILECARE MADE FUN!®



StarSmilez® have served dental professionals and parents alike since 1990. Our purpose is to improve the lives of others as an advocate for great oral health. Through our innovative products we impact millions of smiles worldwide. We support humanitarian programs around the world that share our perspective and strive to infuse our products with creativeness, quality, and uniqueness.

Od 1990 roku pluszaki Star Smilez® są doskonałą pomocą edukacyjną dla dzieci wykorzystywaną zarówno przez stomatologów jak i rodziców. Pragniemy ulepszać życie innych promując higienę jamy ustnej. Nasze innowacyjne produkty wywołują uśmiech na twarzy milionów dzieci na świecie. Wspieramy programy humanitarne, które podzielają naszą filozofię i sięgają po nasze wyjątkowe pluszaki, aby uczyć najmłodszych jak prawidłowo dbać o zęby, by mieć piękny i zdrowy uśmiech.

Star Smilez® Large

Grand sized plush puppets easily articulated through a rear hand entry area
Durable twice life-size dentition is fully flossible with gingival crevices
Built-in water-squirter to demonstrate suction and entertain audiences
Velcro closure to hold a toothbrush
Removable Velcro tongue
300 cm oversize toothbrush
Treated for stain resistance and surface washable

Wielkie pluszowe pacyнки, które można poruszać ręką
Posiadają uzębienie 2 razy większe od naturalnych zębów ludzkich, możliwość demonstracji techniki nitkowania
Wbudowany rozpylacz wody dla demonstracji zasysania oraz zabawienia pacjenta
Zamknięcie na rzep utrzymuje szczoteczkę
Posiadają wyjmowany język mocowany na rzep
Zawierają dużą szczotkę do zębów o długości 30 cm
Odporne na plamy, nadają się do prania



Star Smilez® Small

Compact plush designs for easy handling and storage
1/2 life-size dentition with 4 flossible locations
Bendable arms to hold a toothbrush, instrument, business card, etc
Includes one children's toothbrush
And one Star Smilez® Plush Brush
Treated for stain resistance and surface washable

Zajmują mało miejsca co ułatwia ich przechowywanie i przenoszenie
Posiadają uzębienie 1/2 wielkości naturalnych zębów ludzkich, możliwość demonstracji techniki nitkowania w 4 miejscach
Zginające się ramiona utrzymują szczoteczkę, narzędzie, wizytówkę etc.
Zawierają 1 szczoteczkę dla dzieci
Zawierają 1 pluszową szczoteczkę Star Smilez®
Odporne na plamy, nadają się do prania
Uwaga: Modele małe nie są pacynkami





Teaching aids
Pomoce Dydaktyczne

STAR SMILEZ[®]

SMILECARE MADE FUN![®]

Large - Twice life-size dentition

Duże - z uzębieniem 2 razy większym od naturalnych zębów ludzkich

Wysokość 40-60 cm

Includes 1 large toothbrush

Zawierają 1 dużą szczotkę do zębów



Al E Gator
PA400
Aligator



Ollie Z Mutt
PD700
Pies



Maqi Dragon
PDR1100
Smok

STAR SMILEZ®

SMILECARE MADE FUN!®

Small - Half Life-Size Dentition

Małe - z uzębieniem 1/2 wielkości naturalnych zębów ludzkich

Note: Small models are not puppets / Uwaga: Modele małe nie są pacynkami

Include 1 children and 1 plush toothbrush

Zawierają 1 szczoteczkę do zębów dla dzieci oraz 1 pluszową szczoteczkę

Wysokość 25 cm



NEW



Farley Flossisaurus
SF500
Dinozaur



Tango Tiger
ST500
Tygrys



Cubby Bear
SB500
Niedźwiedź



Lil Maqi Dragon
PPD300
Smok



Lil Ollie Z Mutt
SO500
Pies



Rasta Lion
PPL301
Lew



Allie Gator
PPA200
Krokodyl



Fin Z Fish
PPC200
Ryba



STAR SMILEZ

SMILECARE MADE FUN!®

Large - Twice life-size dentition
Duże - z uzębieniem 2 razy większym od naturalnych zębów ludzkich



NEW

Orthodontic StarSmilez
Pluszak duży z zamkami orto

Wysokość 40-60 cm

Includes 1 large toothbrush
Zawierają 1 dużą szczotkę do zębów



Ollie Z Mutt
ORZ-PD700
Pies



Mojo Monkey
ORZ-PC1000
Małpa



Farley Flossisaurus
ORZ-PF901
Dinozaur

Large demonstration models and toothbrush / Modele pokazowe duże i szczotka do zębów

Twice life size / 2 razy większy od naturalnych zębów ludzkich
Unbreakable / Nielamiący się
Flossible / Odpowiedni do demonstracji techniki nitkowania



TP100X
75 x 90 x 90 mm



BR701
300 mm



DT.9999.00



Children toothbrushes
Szczoteczki do zębów dla dzieci



DH.2102.00
Ladybug toothbrush
Szczoteczka dla dzieci biedronka

Children toothbrushes flashing
Szczoteczki dla dzieci świecące



DH.2101.00

Szczoteczka z timerem czasu mycia. Po włączeniu szczoteczka świeci się przez 2 minuty przez dzieci. Trwałość baterii określana jest na 3 miesiące

Children toothbrushes with suction cup
Szczoteczki do zębów dla dzieci w kropki z przyssawką



DH.2103.00
Suction cup toothbrush
Szczoteczka dla dzieci w kropki

Children toothbrushes flashing liquid
Szczoteczki dla dzieci świecące z brokatem



DH.2100.00

Szczoteczka z timerem czasu mycia. Po włączeniu szczoteczka świeci się przez 2 minuty przez dzieci. Trwałość baterii określana jest na 3 miesiące



Key rings
Breloczki do kluczy



ZP.130.001
Pack of 6 pieces
Opak. 6 szt.



ZP.130.000
Pack of 6 pieces
Opak. 6 szt.



ZP.135.050
Pack of 10 pieces
Opak. 10 szt.



ZP.135.010



ZP.135.020



ZP.132.000
Pack of 6 pieces
Opak. 6 szt.



ZP.131.000
Pack of 6 pieces
Opak. 6 szt.



ZP.135.030



ZP.135.040

Denture boxes for milk teeth
Pudełeczka na zęby mleczne



ZP.110.000
Pack of 20 pieces (4 of each color)
Opak. 20 szt. (po 4 szt. z każdego koloru)

ZP.111.000
Pack of 20 pieces
Opak. 20 szt.

Smilez - Stickers
Nalepki Smilez



ST-200
Roll of 100
Rolka zawiera 100 szt.

Tooth brush holders single
Uchwyty na szczoteczkę do zębów



ZP.150.001
Kitty / Kotek

ZP.150.002
Bunny / Królik

ZP.150.003
Frog / Żaba

ZP.150.004
Cow / Krowa

Hand mirror for patient
Lusterko w kształcie zęba



ZP.151.010

ZP.151.020

ZP.151.030

ZP.151.040

D16

Photography and X-Ray / Akcesoria do zdjęć RTG

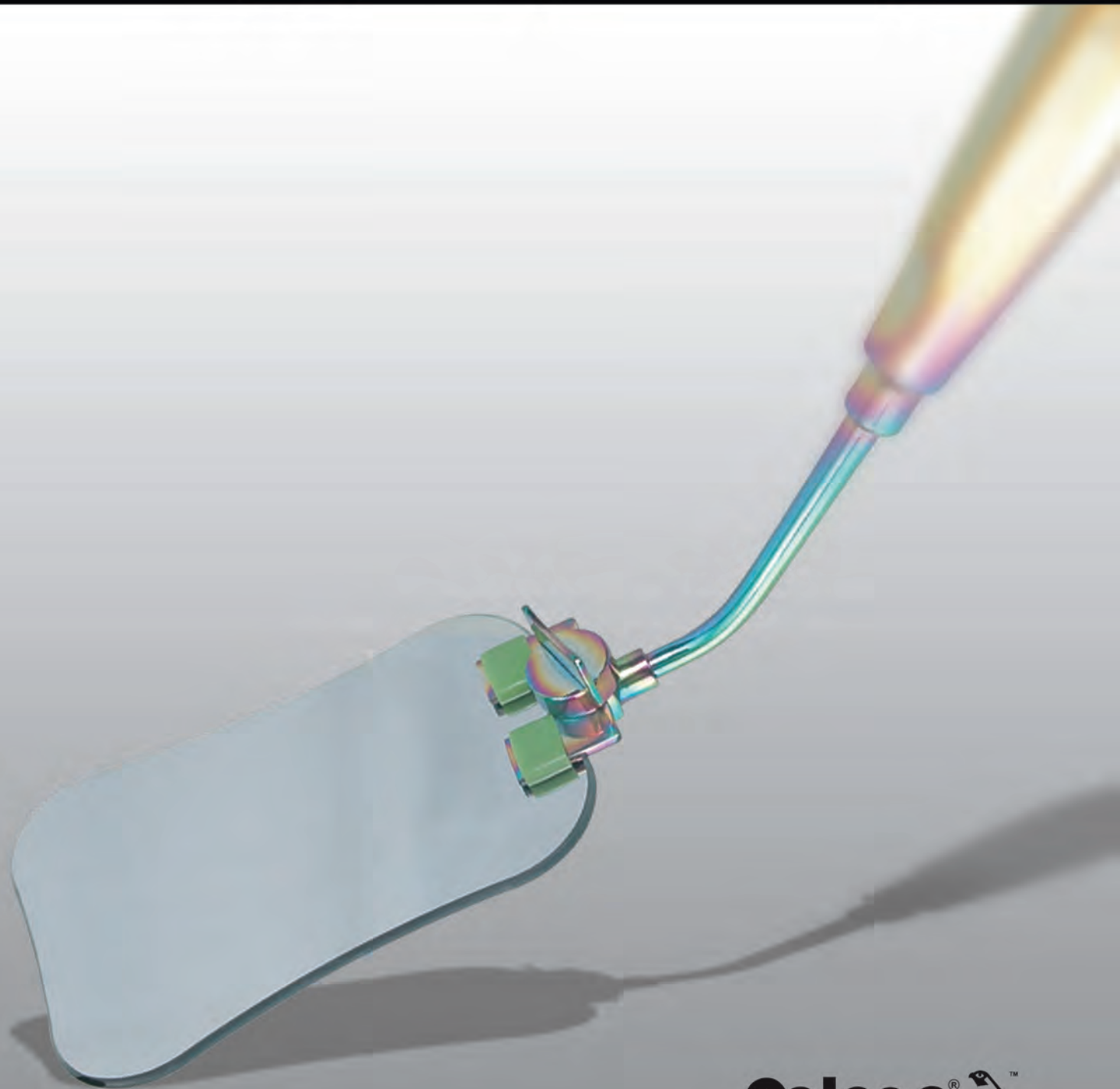



Intraoral photographic mirrors
Fotograficzne lusterka wewnątrzustne

Made of stainless steel
Wykonane ze stali nierdzewnej

 Autoclavable
Możliwość sterylizacji w autoklawie

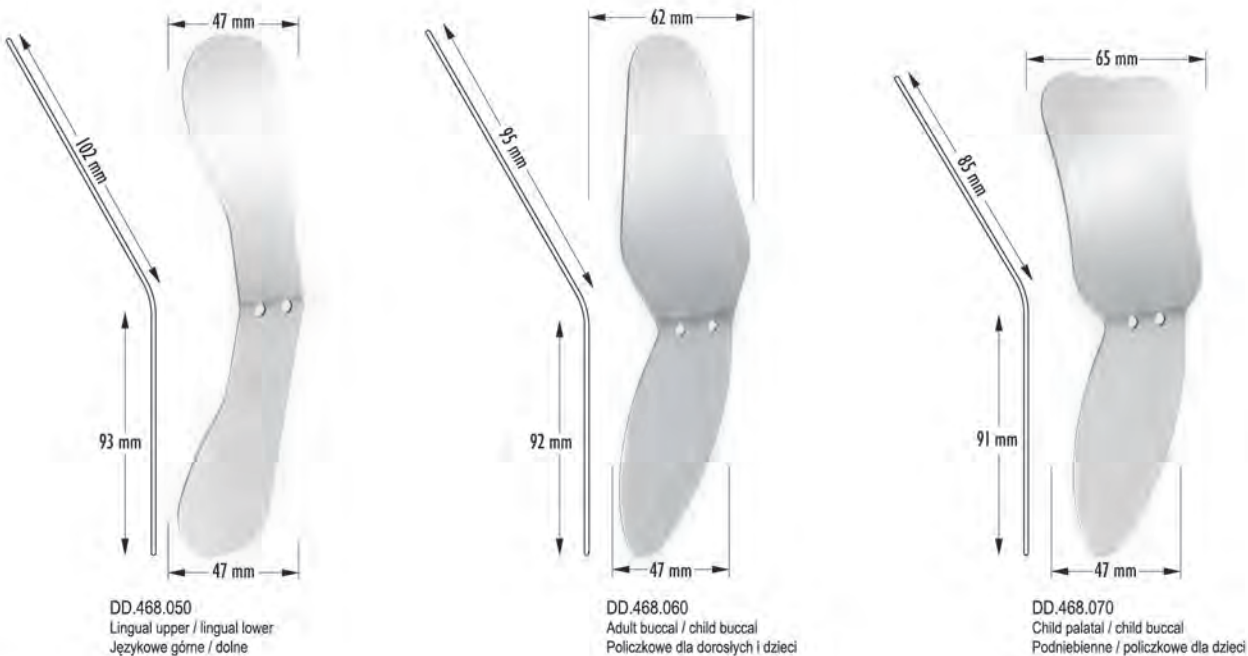
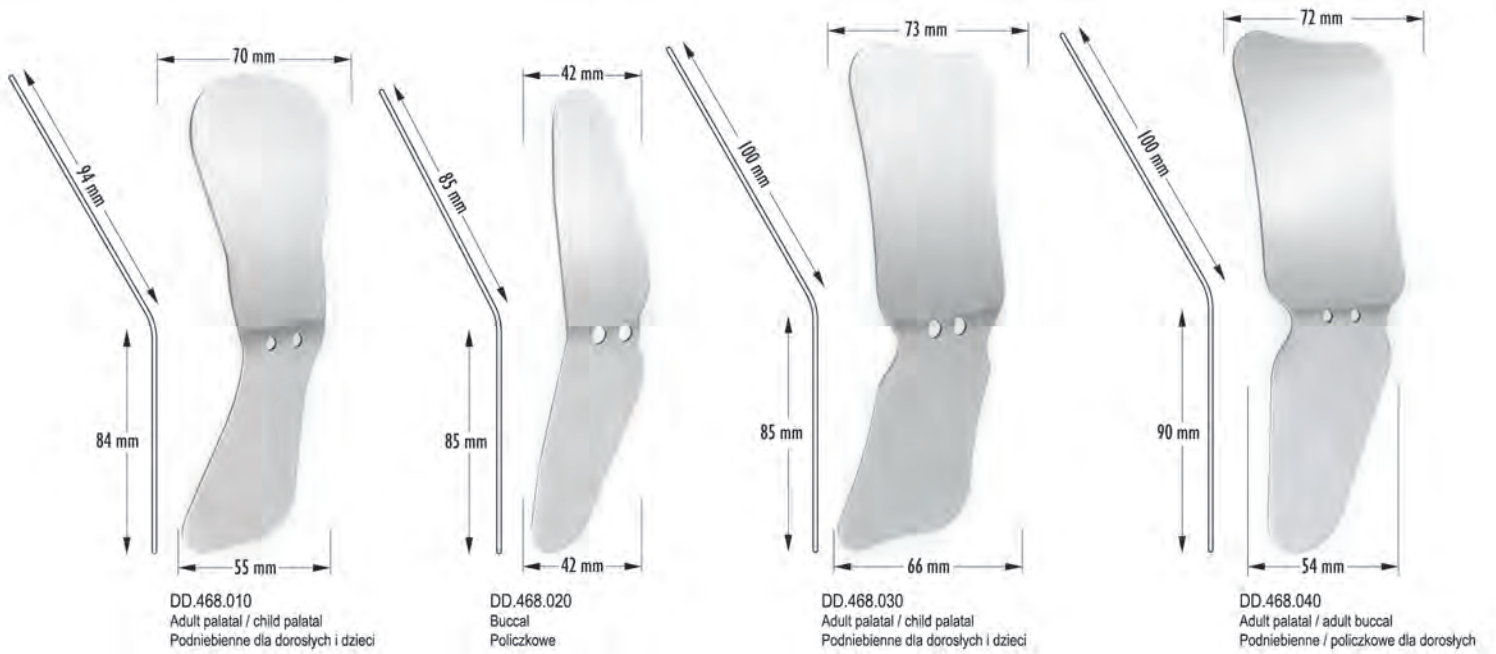

- DD.468.000**
Set of 7 mirrors
Zestaw zawiera 7 lusterek
- 1 x DD.468.010
 - 1 x DD.468.020
 - 1 x DD.468.030
 - 1 x DD.468.040
 - 1 x DD.468.050
 - 1 x DD.468.060
 - 1 x DD.468.070



Intraoral photographic mirrors
Fotograficzne lusterka wewnątrzne



Double sided front surface
No double reflection
Chromium coated glass
Provides sharp images

Dwustronne, przedniopowierzchniowe
Brak efektu 'podwójnego odbicia'
Szkło, pokryte chromem
Zapewniają wyraźny obraz



Autoclavable
Możliwość sterylizacji w autoklawie

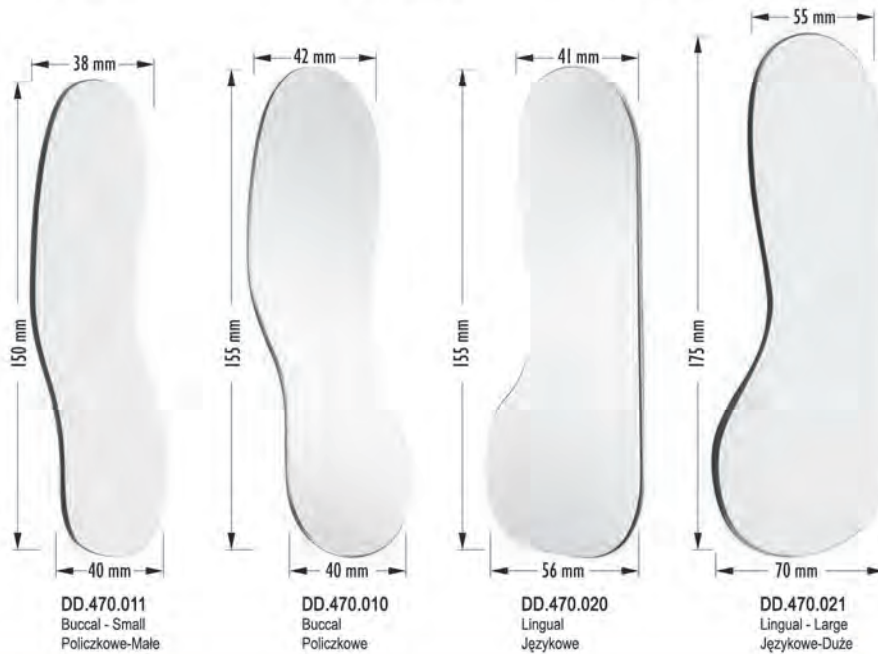
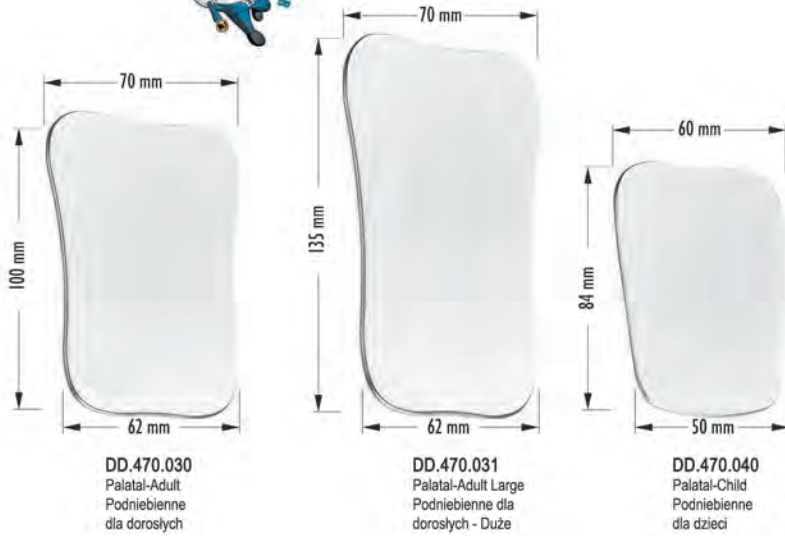

DD.470.000
Set of 7 mirrors and 1 handle:
Zestaw zawiera 7 lusterek i 1 uchwył:
1 x DD.470.010
1 x DD.470.011
1 x DD.470.020
1 x DD.470.021
1 x DD.470.030
1 x DD.470.031
1 x DD.470.040
1 x DD.472.000

Large mirrors with handle
Duże lusterka z uchwytem



For intraoral photography
Bendable at any angle
Chrome front surface
No double reflection
Autoclavable

Do zdjęć wewnątrznych
Wygina się pod każdym kątem
Pokryte chromem, przedniopowierzchniowe
Brak efektu 'podwójnego odbicia'
Możliwość sterylizacji w autoklawie

DD.471.010 Ø 38mm
DD.471.020 Ø 50mm

Sterilization cassette for photographic mirrors
Kaseta do sterylizacji lusterek fotograficznych



DZ.085.090
Suitable for all Intraoral photographic mirrors
Odpowiednia do wszystkich
typów lusterek fotograficznych



Contrastors / Kontrastory

 Autoclavable
Możliwość sterylizacji w autoklawie



DD.476.010
Anterior-Small
Mały - do zębów przednich



DD.476.020
Anterior-Large
Duży - do zębów przednich



DD.475.050
Anterior
Do zębów przednich



DD.475.060
Posterior
Do zębów tylnych



DD.475.070
Occlusal-Small
Mały - do zgryzu



DD.475.080
Occlusal-Medium
Średni - do zgryzu



DD.475.090
Occlusal-Large
Duży - do zgryzu

Soft contrastors / Soft kontrastory



DD.476.060
Anterior
Do zębów przednich



DD.476.070
Occlusal
Do zgryzu



Photo cheek and lip retractors
Rozwieraki policzkowe do ust i zdjęć



DS.435.010B
Simplex
105 mm



DS.435.000B
Simplex 1/2 CUT
105 mm
Pair (Left and Right)
Ends trimmed for easier occlusal view



DS.435.020B
Simplex-Falcon
110 mm



DS.435.030B
Simplex-Falcon
170 mm
V-Shape, excellent for
pulling back the cheek



DS.437.010B
Falcon
170 mm
Lip retractor, excellent
for occlusal photos



DS.435.010
Simplex
105 mm



DS.435.000
Simplex 1/2 CUT
105 mm
Pair (Left and Right)
Ends trimmed for easier occlusal view



DS.435.020
Simplex-Falcon
110 mm



DS.435.030
Simplex-Falcon
170 mm
V-Shape, excellent for
pulling back the cheek



DS.437.010
Falcon
170 mm
Lip retractor, excellent
for occlusal photos



Photo cheek retractors
Rozwieraki do zdjęć

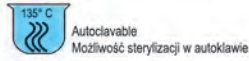

Black / Czarny



Small / Mały
DS.434.040

Black / Czarny



Large / Duży
DS.434.030



Black / Czarny



Small / Mały
DS.434.070

Black / Czarny



Large / Duży
DS.434.080



Transparent / Przezroczysty



Small / Mały
DS.434.050

Transparent / Przezroczysty



Large / Duży
DS.434.060



Transparent / Przezroczysty



Small / Mały
DS.434.090

Transparent / Przezroczysty



Large / Duży
DS.434.100

Handle for photographic mirrors
Uchwyt do lusterka fotograficznego

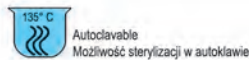

Designed by
Zaprojektowany przez
FALCON



Aluminium / Aluminiowe



DD.472.010
Silver



DD.472.020
Black



DD.472.030
Green



DD.472.040
Pink



376
DD.472.000
Stainless Steel
Stal nierdzewna

Photo cheek retractors
Rozwieraki do zdjęć



152mm
Small / Mały
DS.434.010A



165mm
Large / Duży
DS.434.020A



X-Ray Positioners / Pozycjonery do wykonywania zdjęć RTG

Parallelism Technique / Technika cyfrową

- Better Diagnosis, Less Distortion, Avoids Repetitions
- Eliminują błędy i nakładanie się struktur na zdjęciu rtg, a tym samym konieczność powtarzania zdjęć.



Autoclavable
Możliwość sterylizacji w autoklawie

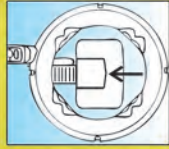

X-ray positioners mini kits / Mini zestawy pozycjonerów do wykonywania zdjęć RTG



DD.1201.00
Anterior / Do zdjęć zębowych przednich



Contents / Zestaw zawiera:
1 x Indicator arm / Pręt mocujący
1 x Aiming ring / Pierścień centrujący
1 x Film holder / Zagryzak



DD.1201.02
Aiming ring / Pierścień centrujący

DD.1201.01
Film holder / Zagryzak



DD.1201.03
Indicator arm / Pręt mocujący



DD.1202.00
Posterior / Do zdjęć zębowych bocznych

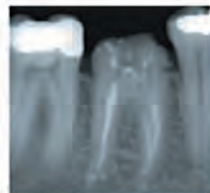

Contents / Zestaw zawiera:
1 x Indicator arm / Pręt mocujący
1 x Aiming ring / Pierścień centrujący
1 x Film holder / Zagryzak



DD.1202.02
Aiming ring / Pierścień centrujący

DD.1202.01
Film holder / Zagryzak

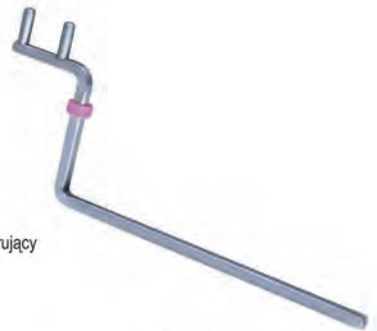

DD.1202.03
Indicator arm / Pręt mocujący



DD.1203.00
Bite-Wing / Do zdjęć skrzydłowo-zgrzyzowych

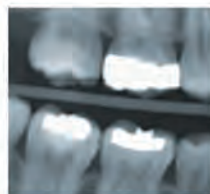

Contents / Zestaw zawiera:
1 x Indicator arm / Pręt mocujący
1 x Aiming ring / Pierścień centrujący
1 x Film holder / Zagryzak



DD.1203.02
Aiming ring / Pierścień centrujący

DD.1203.01
Film holder / Zagryzak



DD.1203.03
Indicator arm / Pręt mocujący



X-ray positioners mini kit, Endo / Mini zestaw pozycjonerów do zdjęć endodontycznych



DD.1206.00
Contents / Zawiera:
1 x Indicator arm / Pręt mocujący
1 x Aiming ring / Pierścień centrujący
1 x Film holder / Zagryzak



DD.1206.02
Aiming ring / Pierścień centrujący



Autoclavable
Możliwość sterylizacji w autoklawie



DD.1206.03
Indicator arm / Pręt mocujący



DD.1206.01
Film holder / Zagryzak

X-Ray Positioners Set
Zestaw pozycjonerów do wykonywania zdjęć RTG



Autoclavable
Możliwość sterylizacji w autoklawie

Anterior / Do zębów przednich

Posterior / Do zębów bocznych

Bite-Wing / Do zgryzu

Endo / Do zdjęć endodontycznych



DD.1200.00
Contents / Zestaw zawiera:
2 x Indicator arms / Pręty mocujące
2 x Aiming rings / Pierścienie centrujące
6 x Film holders / Zagryzaków



2 x Indicator arms / Pręty mocujące
2 x Aiming rings / Pierścienie centrujące
10 x Film holders / Zagryzaków



1 x Indicator arm / Pręt mocujący
1 x Aiming ring / Pierścień centrujący
4 x Film holders / Zagryzaki



1 x Indicator arm / Pręt mocujący
1 x Aiming ring / Pierścień centrujący
4 x Film holders / Zagryzaki

X-Ray accessories
Akcesoria do zdjęć RTG



DZ.9000.04
Black for X-ray protection
Okulary czarne, chroniące
przed promieniami RTG



DZ.970.010
X-Ray clip
Klips do zdjęć



Fig. 10
DZ.972.100
X-Ray hanger 10 clips
Wieszak do zdjęć 10 uchwytów



Fig. 14
DZ.972.140
X-Ray hanger 14 clips
Wieszak do zdjęć 14 uchwytów



X-Ray protective aprons Fartuchy ochronne jednostronne stomatologiczne

A series of products designed to protect against radiation has been designed to combine comfort and uncompromised protection against secondary radiation. Made of lightweight, flexible and multi-lead rubber providing excellent performance.

Seria produktów służących zabezpieczeniu przed promieniowaniem została zaprojektowana, aby pogodzić wygodę i bezkompromisową ochronę przed promieniowaniem wtórnym. Wykonane zostały z lekkiej wielowarstwowej i elastycznej gumy ołowiowej zapewniającej doskonałościwości użytkowe.

Typ: JA (STANDARD) – zabezpiecza przód, boki i łopatki użytkownika. Do części okrywających łopatki doszyte są taśmy poliestrowe zakończone klamrami zatraskowymi, służące do zapinania fartucha w pasie.

Typ: DS (PŁASZCZ) – posiada poduszki łagodzące nacisk na barki i wygodne zapięcia typu rzep. Fartuch zapinany jest "na zakładkę".

Typ: DO (PONCHO) – posiada poduszki łagodzące nacisk na barki i zapięcia na bokach w postaci taśm z klamrami zatraskowymi.



Type / Typ: JA (STANDARD)



Type / Typ: DS (PŁASZCZ)



Type / Typ: DO (PONCHO)

Size / Rozmiar

Lightweight – 0.25 mm Pb on all surface / Lekkie – 0.25 mm Pb na całej powierzchni

Mały 42 x 50 cm, 3 do 5 lat
Średni 46 x 60 cm, 6 do 8 lat
Duży 50 x 70 cm, 9 do 12 lat

DD.1310.01
DD.1310.02
DD.1310.03

DD.1310.10
DD.1310.11
DD.1310.12

DD.1310.19
DD.1310.20
DD.1310.21

Size / Rozmiar

Heavy – 0.35 mm Pb on all surface / Ciężkie – 0.35 mm Pb na całej powierzchni

Mały 42 x 50 cm, 3 do 5 lat
Średni 46 x 60 cm, 6 do 8 lat
Duży 50 x 70 cm, 9 do 12 lat

DD.1310.04
DD.1310.05
DD.1310.06

DD.1310.13
DD.1310.14
DD.1310.15

DD.1310.22
DD.1310.23
DD.1310.24

Size / Rozmiar

Heavy – 0.50 mm Pb on all surface / Ciężkie – 0.50 mm Pb na całej powierzchni

Mały 42 x 50 cm, 3 do 5 lat
Średni 46 x 60 cm, 6 do 8 lat
Duży 50 x 70 cm, 9 do 12 lat

DD.1310.07
DD.1310.08
DD.1310.09

DD.1310.16
DD.1310.17
DD.1310.18

DD.1310.25
DD.1310.26
DD.1310.27

Colors available:
Dostępne kolory:



Attention: All aprons are made to order. Delivery time 2 weeks.

Uwaga: Fartuchy szyte na zamówienie. Czas oczekiwania około 2 tygodni.

Typ: ST (STANDARD)
– zabezpiecza przód i barki użytkownika.



Type / Typ: ST (Standard)

Typ: SK (Z OSŁONĄ TARCZYCY)
– zabezpiecza przód, barki i tarczycę użytkownika.



Type / Typ: SK (With thyroid collar)

Typ: SP (PANTOMOGRAFICZNY)
– zabezpieczają przód, barki i kręgosłup użytkownika.



Type / Typ: SP (Panoramic)

Size / Rozmiar

Lightweight – 0.25 mm Pb on all surface / Lekkie – 0.25 mm Pb na całej powierzchni

50 x 80 cm
40 x 60 cm

DD.1360.01
DD.1360.02

DD.1365.01
DD.1365.02

DD.1370.01
DD.1370.03

Size / Rozmiar

Heavy - 0.35 mm Pb in front and 0.25 mm on other parts / Ciężkie - 0.35mm Pb z przodu i 0.25 mm pozostałych częściach

50 x 80 cm
40 x 60 cm

DD.1360.03
DD.1360.04

DD.1365.03
DD.1365.04

DD.1370.03
DD.1370.04

Size / Rozmiar

Heavy - 0.50 mm Pb in front and 0.25 mm on other parts / Ciężkie - 0.50mm Pb z przodu i 0.25 mm pozostałych częściach

50 x 80 cm
40 x 60 cm

DD.1360.05
DD.1360.06

DD.1365.05
DD.1365.06

DD.1370.05
DD.1370.06

Colors available:
Dostępne kolory:



Attention: All aprons are made to order. Delivery time 2 weeks.

Uwaga: Fartuchy szyte na zamówienie. Czas oczekiwania około 2 tygodni.



Zapytaj o cenę

Thyroid protection collar
Kołnier ochronny

Typ: AT – chroni obszar szyi podczas ekspozycji rentgenowskiej. Wykonana w formie stójki ze "ślinaikiem" i zapięciem typu "rzep". Dostępna w trzech rozmiarach S (prosta), M (ślinaik 8 cm), L (ślinaik 12 cm) oraz równoważnikach Pb (0,35 mm; 0,50 mm)



Small / Mały



Medium / Średni



Large / Duży

Heavy – 0.35 mm Pb on all surface / Ciężkie – 0.35 mm Pb na całej powierzchni

Code / Kod DD.1312.01

DD.1312.03

DD.1312.05

Heavy – 0.50 mm Pb on all surface / Ciężkie – 0.50 mm Pb na całej powierzchni

Code / Kod DD.1312.02

DD.1312.04

DD.1312.06

Colors available:
Dostępne kolory:



Attention: All Thyroid protection collar are made to order. Delivery time 2 weeks.
Uwaga: Kołnier ochronny szyte na zamówienie. Czas oczekiwania około 2 tygodni.

X-Ray Illuminators
Negataskopy



PANORAM-01
DQ.8000.01

Screen size: 285 x 155 mm
Dimensions: 358 x 172 x 65 mm
X-Ray film viewer for pantomograms
Desktop or wall mounted

Wymiar ekranu: 285 x 155 mm
Wymiar negataskopu: 358 x 172 x 65 mm
Do zdjęć pantomograficznych
Stojący lub wiszący



CEFALOM-01
DQ.8010.01

Screen size: 240 x 300 mm
Dimensions: 370 x 330 x 70 mm
X-Ray film viewer for cephalograms
Desktop

Wymiar ekranu: 240 x 300 mm
Wymiar negataskopu: 370 x 330 x 70 mm
Do zdjęć cefalometrycznych
Stojący

D17

Sterilization and Sundries / Sterylizacja i Inne

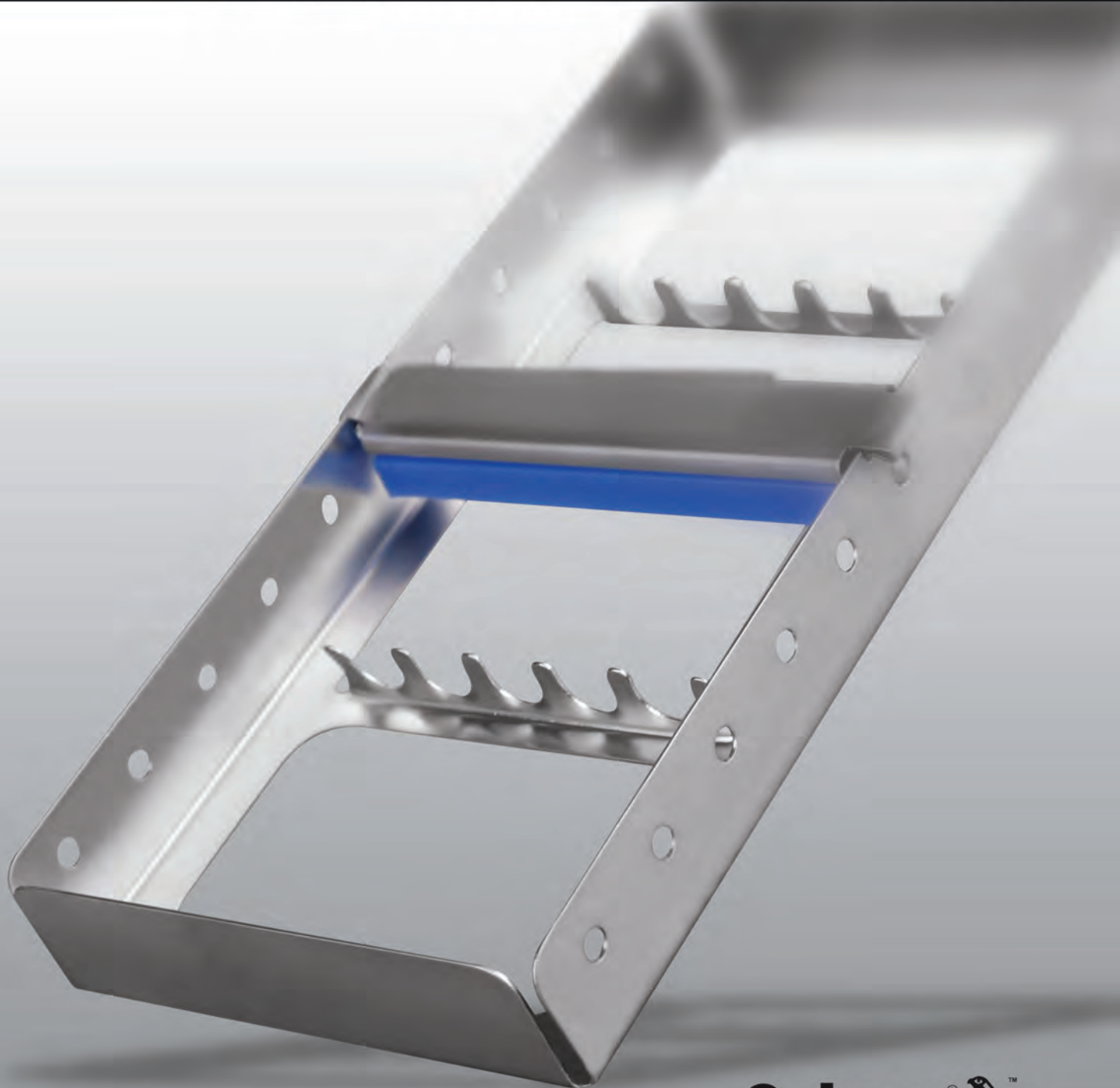



Sterilization and Sundries Sterylizacja i Inne

Containers Mini Kontenery Mini

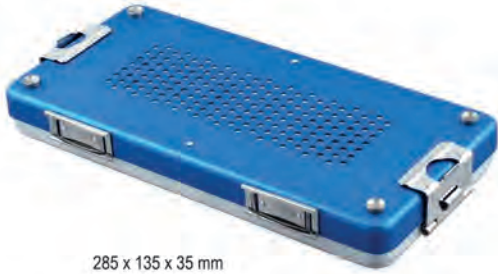

285 x 135 x 35 mm



285 x 135 x 60 mm

Perforated lid + non perforated bottom
Perforowana pokrywa + nieperforowana wanna

Perforated lid + perforated bottom
Perforowana pokrywa + perforowana wanna

Perforated lid + non perforated bottom
Perforowana pokrywa + nieperforowana wanna

Perforated lid + perforated bottom
Perforowana pokrywa + perforowana wanna

SS.500.010 ■ Black / Czarny
SS.500.020 ■ Blue / Niebieski
SS.500.030 ■ Golden / Złoty
SS.500.040 ■ Green / Zielony
SS.500.050 ■ Red / Czerwony
SS.500.060 ■ Silver / Srebrny

SS.503.010 ■ Black / Czarny
SS.503.020 ■ Blue / Niebieski
SS.503.030 ■ Golden / Złoty
SS.503.040 ■ Green / Zielony
SS.503.050 ■ Red / Czerwony
SS.503.060 ■ Silver / Srebrny

SS.501.010 ■ Black / Czarny
SS.501.020 ■ Blue / Niebieski
SS.501.030 ■ Golden / Złoty
SS.501.040 ■ Green / Zielony
SS.501.050 ■ Red / Czerwony
SS.501.060 ■ Silver / Srebrny

SS.504.010 ■ Black / Czarny
SS.504.020 ■ Blue / Niebieski
SS.504.030 ■ Golden / Złoty
SS.504.040 ■ Green / Zielony
SS.504.050 ■ Red / Czerwony
SS.504.060 ■ Silver / Srebrny

Containers dental perforated Kontenery stomatologiczne perforowane



SS.512.060
285 x 185 x 130 mm



SS.511.060
285 x 185 x 65 mm



SS.510.060
285 x 185 x 45 mm

Drape retainers Ramki zaciskowe do serwet



SS.612.280
for mini containers
do kontenerów mini
280x125 mm

SS.612.310
for dental containers
do kontenerów stomatologicznych
310 x 190 mm

Cotton drapes Serwety bawełniane

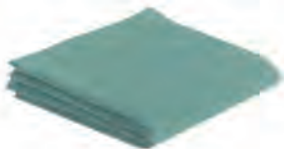

SS.670.600
600 x 400 mm

SS.670.650
650 x 650 mm

SS.670.850
850 x 850 mm

Disposable paper filters for containers Jednorazowe filtry papierowe do kontenerów



SS.672.010
for mini containers / do kontenerów mini
Pack of 100 pieces / Opak. 100 szt.

SS.672.020
for dental containers / do kontenerów stomatologicznych
Pack of 100 pieces / Opak. 100 szt.

Disposable labels with steam indicators Jednorazowe identyfikatory procesu sterylizacji



SS.675.010
for mini and dental containers
do kontenerów mini i stomatologicznych
Pack of 100 pieces / Opak. 100 szt.



Sterilization cassettes / Kasetki do sterylizacji

TWIST-LOCK

Sterilization cassettes / Kasetki do sterylizacji z zamkiem

Secure lock to avoid accidental opening. Suitable for ultrasonic baths, disinfectors, autoclaves.
Posiadają bezpieczny zamek aby uniknąć przypadkowego otwarcia. Pasują do myjek ultradźwiękowych, dezynfektorów, autoklawów.

TWIST-LOCK
Rotate to open
Obróć aby otworzyć



Maxi
DZ.086.030 ■ Blue / Niebieska
DZ.086.033 ■ Green / Zielona
DZ.086.035 ■ Red / Czerwona
DZ.086.039 ■ Yellow / Żółta
Stainless Steel for 20 instruments
Stal nierdzewna na 20 instrumentów
288 x 182 x 34 mm



Midi
DZ.086.020 ■ Blue / Niebieska
DZ.086.023 ■ Green / Zielona
DZ.086.025 ■ Red / Czerwona
DZ.086.029 ■ Yellow / Żółta
Stainless Steel for 10 instruments
Stal nierdzewna na 10 instrumentów
182 x 144 x 34 mm

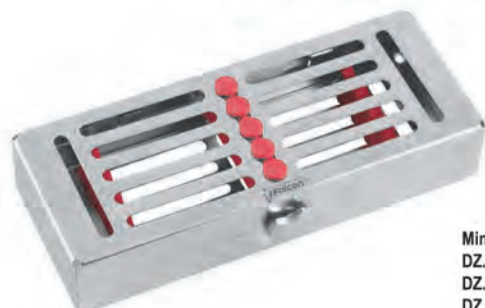

Mini
DZ.086.010 ■ Blue / Niebieska
DZ.086.013 ■ Green / Zielona
DZ.086.015 ■ Red / Czerwona
DZ.086.019 ■ Yellow / Żółta
Stainless Steel for 5 instruments
Stal nierdzewna na 5 instrumentów
182 x 72 x 34 mm

Petite

Sterilization cassettes / Kasetki do sterylizacji

Slim and small design, ideal for diagnostic or other small sets. Suitable for ultrasonic baths, disinfectors, autoclaves (can be placed in pouches).

Wąskie i niskie, odpowiednie do sterylizacji zestawów diagnostycznych i innych małych zestawów. Pasują do myjek ultradźwiękowych, dezynfektorów, autoklawów (mieszczą się w torebki do sterylizacji).

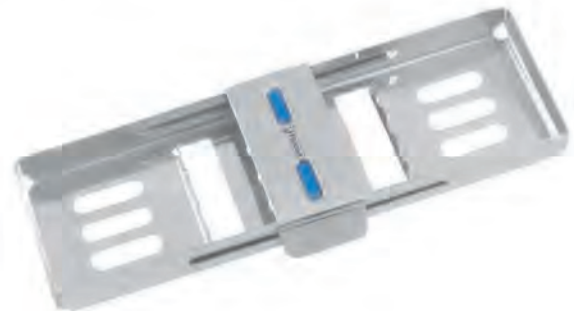

DZ.094.000
Stainless steel for 3 instruments
Stal nierdzewna na 3 instrumenty
180 x 60 x 15 mm



DZ.095.000
Stainless steel for 5 instruments
Stal nierdzewna na 5 instrumentów
180 x 80 x 15 mm

Mesh

Sterilization cassettes / Kasetki do sterylizacji



DZ.088.010 ■ Blue/Niebieska
DZ.088.013 ■ Green/Zielona
DZ.088.015 ■ Red/Czerwona
DZ.088.019 ■ Yellow/Żółta
Stainless Steel for 5 instruments
Stal nierdzewna na 5 instrumentów
200 x 80 x 35mm

DZ.088.020 ■ Blue/Niebieska
DZ.088.023 ■ Green/Zielona
DZ.088.025 ■ Red/Czerwona
DZ.088.029 ■ Yellow/Żółta
Stainless Steel for 7 instruments
Stal nierdzewna na 7 instrumentów
200 x 105 x 35 mm



Sterilization and Sundries Sterylizacja i Inne

Sterilization cassettes / Kasetki do sterylizacji



Mini

- DZ.085.010 ■ Blue/Niebieska
- DZ.085.013 ■ Green/Zielona
- DZ.085.015 ■ Red/Czerwona
- DZ.085.019 ■ Yellow/Żółta

Stainless Steel for 5 instruments
Stal nierdzewna na 5 instrumentów
180 x 60 x 22mm



Midi

- DZ.085.020 ■ Blue/Niebieska
- DZ.085.023 ■ Green/Zielona
- DZ.085.025 ■ Red/Czerwona
- DZ.085.029 ■ Yellow/Żółta

Stainless Steel for 10 instruments
Stal nierdzewna na 10 instrumentów
180 x 125 x 22 mm



Maxi

- DZ.085.030 ■ Blue/Niebieska
- DZ.085.033 ■ Green/Zielona
- DZ.085.035 ■ Red/Czerwona
- DZ.085.039 ■ Yellow/Żółta

Stainless Steel for 20 instruments
Stal nierdzewna na 20 instrumentów
245 x 180 x 25 mm



Spare silicone inserts / Silikonowa wkładka do kasetki



Mini

DZ.085.010B Blue/Niebieska

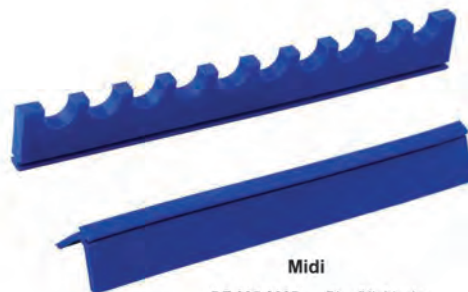

Midi

DZ.085.020B Blue/Niebieska



Sterilization cassettes / Kasetki do sterylizacji



Autoclavable
Możliwość sterylizacji w autoklawie



Mini
DZ.095.010
Stainless Steel, for 7 instruments
Stal nierdzewna na 7 instrumentów
185 x 100 x 15mm



Midi
DZ.095.020
Stainless Steel, for 10 instruments
Stal nierdzewna na 10 instrumentów
185 x 140 x 15mm



Midi
DZ.092.080
Stainless Steel, for 8 instruments
Stal nierdzewna na 8 instrumentów
190 x 140 x 25mm

Plastic cassettes and trays / Tacki i kasetki plastikowe



Autoclavable
Możliwość sterylizacji w autoklawie



DZ.084.010 Blue / Niebieska
DZ.084.020 Green / Zielona
DZ.084.030 Orange / Pomarańczowa
DZ.084.040 Red / Czerwona
DZ.084.050 White / Biała
DZ.084.060 Yellow / Żółta
185 x 100 x 20 mm



DZ.083.010 Blue / Niebieska
DZ.083.020 Green / Zielona
DZ.083.030 Orange / Pomarańczowa
DZ.083.040 Red / Czerwona
DZ.083.050 White / Biała
DZ.083.060 Yellow / Żółta
205 x 50 x 45 mm



240 x 165 x 20 mm

DZ.390.010 Blue / Niebieska
DZ.390.020 Green / Zielona
DZ.390.030 Lavender / Lawendowa
DZ.390.050 White / Biała
DZ.390.060 Yellow / Żółta
DZ.390.070 Light blue / Jasnyniebieska



340 x 245 x 20 mm

DZ.391.010 Blue / Niebieska
DZ.391.020 Green / Zielona
DZ.391.030 Lavender / Lawendowa
DZ.391.040 White / Biała
DZ.391.050 Pink / Różowa



280 x 170 x 290mm

DZ.390.000S
for 6 trays / na 6 tacek
Instruments trays rack +
6 plastic trays size 240 x 165 x 20mm
Stojak na tacki plastikowe +
6 tacek plastikowe roz 240 x 165 x 20mm



Maxi aluminum trays and accessories / Tacki aluminiowe maxi i akcesoria

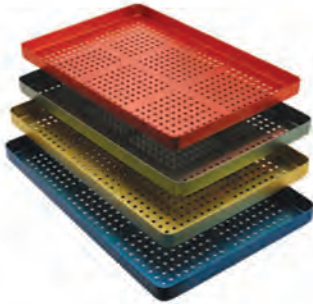

Perforated trays / Tacki perforowane

- DZ.400.010 ■ Blue/Niebieskie
 - DZ.400.020 ■ Golden/Złote
 - DZ.400.030 ■ Green/Zielone
 - DZ.400.040 ■ Red/Czerwone
 - DZ.400.050 ■ Silver/Srebrne
- 284 x 183 x 17mm



Solid trays / Tacki nieperforowane

- DZ.401.010 ■ Blue/Niebieskie
 - DZ.401.020 ■ Golden/Złote
 - DZ.401.030 ■ Green/Zielone
 - DZ.401.040 ■ Red/Czerwone
 - DZ.401.050 ■ Silver/Srebrne
- 284 x 183 x 17mm

Perforated cover / Przykrywka perforowana

- DZ.402.010 ■ Silver/Srebrna
- 288 x 187 x 29 mm

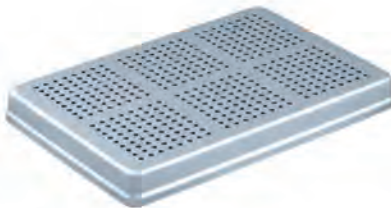

Solid cover / Przykrywka nieperforowana

- DZ.402.020 ■ Silver/Srebrna
- 288 x 187 x 29 mm

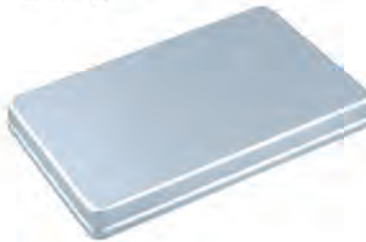

Instrument trays rack / Stojak na tacki maxi



DZ.435.020
295 x 190 x 270mm

for 6 maxi trays
na 6 tackach

**Racks for instruments
Przegrodki na instrumenty**



DZ.430.070
for 15 instruments
na 15 instrumentów

DZ.430.080
for 23 instruments
na 23 instrumenty

DZ.430.071
for 17 instruments
na 17 instrumentów

Midi aluminum trays and accessories / Tacki aluminiowe midi i akcesoria

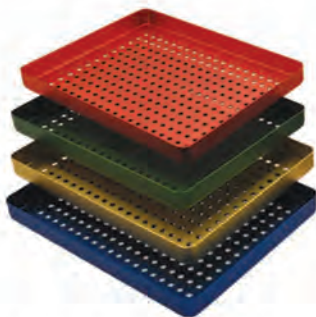

Perforated trays / Tacki perforowane

- DZ.405.010 ■ Blue/Niebieskie
 - DZ.405.020 ■ Golden/Złote
 - DZ.405.030 ■ Green/Zielone
 - DZ.405.040 ■ Red/Czerwone
 - DZ.405.050 ■ Silver/Srebrne
- 183 x 140 x 17mm

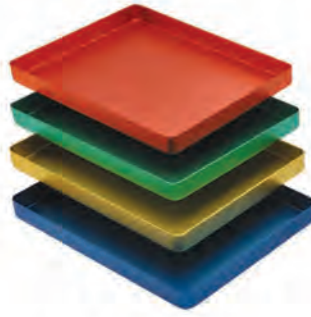

Solid trays / Tacki nieperforowane

- DZ.406.010 ■ Blue/Niebieskie
 - DZ.406.020 ■ Golden/Złote
 - DZ.406.030 ■ Green/Zielone
 - DZ.406.040 ■ Red/Czerwone
 - DZ.406.050 ■ Silver/Srebrne
- 183 x 140 x 17mm

Perforated cover / Przykrywka perforowana

- DZ.407.010 ■ Silver/Srebrna
- 187 x 145 x 25 mm



Solid cover / Przykrywka nieperforowana

- DZ.407.020 ■ Silver/Srebrna
- 187 x 145 x 25 mm



Instrument trays rack / Stojak na tacki midi



DZ.435.010
150 x 180 x 270mm

for 6 midi trays
na 6 tackach

**Racks for instruments
Przegrodki na instrumenty**



DZ.408.020
for 4 instruments
na 4 instrumenty

DZ.408.010
for 8 instruments
na 8 instrumentów



Mini aluminum trays and accessories
Tacki aluminiowe mini i akcesoria

Solid trays / Tacki nieperforowane
DZ.410.010 Blue/Niebieskie
DZ.410.020 Golden/Złote
DZ.410.030 Green/Zielone
DZ.410.040 Red/Czerwone
DZ.410.050 Silver/Srebrne
180 x 100 x 11mm

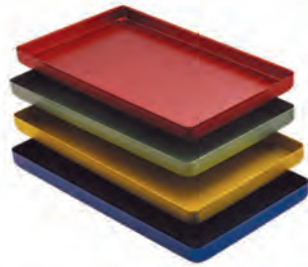

Solid cover / Przykrywka nieperforowana
DZ.411.020 Silver/Srebrna
182 x 103 x 13 mm



Instrument box perforated
Pudełko na instrumenty perforowane



DZ.467.000
stainless steel / stal nierdzewna
180 x 90 x 30 mm

Aluminum inserts
Wkładki aluminiowe



Fig. 1
DZ.415.010
49 x 26 x 10mm



Fig. 2
DZ.415.020
49 x 26 x 10mm



Fig. 3
DZ.415.030
59 x 49 x 10mm



Fig. 4
DZ.415.040
59 x 49 x 10mm

Instrument trays stainless steel maxi
Tacki ze stali nierdzewnej maxi



DZ.430.010
Solid cover / Przykrywka nieperforowana
288 x 187 x 29 mm



DZ.430.020
Perforated cover / Przykrywka perforowana
288 x 187 x 29 mm



DZ.430.030
Perforated tray / Tacka perforowana
284 x 183 x 19 mm



DZ.430.040
Solid tray / Tacka nieperforowana
284 x 183 x 19 mm



DZ.430.000
288 x 187 x 40 mm
Complete / Komplet
DZ.430.010
DZ.430.030
DZ.430.070



DZ.431.000
288 x 187 x 40 mm
Complete / Komplet
DZ.430.020
DZ.430.030
DZ.430.070



DZ.432.000
288 x 187 x 40 mm
Complete / Komplet
DZ.430.010
DZ.430.040
DZ.430.070



Sterilization and Sundries Sterylizacja i Inne

Instrument trays stainless steel Tacki na instrumenty ze stali nierdzewnej



Fig. 1
DZ.420.010
185 x 80 x 15mm



Fig. 2
DZ.420.020
190 x 100 x 17mm



Fig. 3
DZ.420.030
190 x 100 x 25mm



Fig. 4
DZ.420.040
190 x 100 x 15mm



Fig. 5
DZ.420.050
190 x 135 x 15mm



DZ.420.031
Cover for DZ.420.030
Przykrywka do tacki DZ.420.030

Mayo trays perforated Tacki Mayo perforowane



Code / Kod	Size / Rozmiar mm		
	A	B	C
SH.400.150	200	150	15
SH.404.150	250	150	15
SH.404.200	250	200	15
SH.407.200	300	200	15
SH.407.250	300	250	15
SH.410.250	350	250	15
SH.413.300	400	300	20
SH.416.350	455	350	20

Mayo trays Tacki Mayo



Code / Kod	Size / Rozmiar mm		
	A	B	C
SH.420.150	200	150	15
SH.424.150	250	150	15
SH.424.200	250	200	15
SH.427.200	300	200	15
SH.427.250	300	250	15
SH.430.250	350	250	15
SH.433.300	400	300	20
SH.436.350	455	350	20

Shallow model / Model płytki



Code / Kod	Size / Rozmiar mm		
	A	B	C
SH.170.150	200	150	25
SH.174.150	230	150	35
SH.177.200	250	200	35
SH.180.200	300	200	35
SH.180.250	300	250	35
SH.180.300	300	300	35
SH.184.250	350	250	35
SH.188.300	400	300	35
SH.192.350	455	350	35
SH.204.380	610	380	35
SH.205.455	610	455	35

Deep model / Model głęboki



Code / Kod	Size / Rozmiar mm		
	A	B	C
SH.220.150	200	150	40
SH.224.150	230	150	50
SH.227.200	250	200	50
SH.230.200	300	200	50
SH.230.250	300	250	50
SH.230.300	300	300	50
SH.234.250	350	250	50
SH.238.300	400	300	50
SH.242.350	455	350	50
SH.254.380	610	380	50
SH.255.455	610	455	50



Instrument trays
Tacki na instrumenty



Code / Kod	Size / Rozmiar mm		
	A	B	C
SH.152.075	125	75	25
SH.155.120	150	120	30

Sterilizing drums
Puszki do sterylizacji



Code / Kod	Ø x H mm
SS.852.080	125 x 80
SS.850.125	125 x 125
SS.850.140	140 x 140
SS.850.150	150 x 150
SS.855.150	190 x 150
SS.850.190	190 x 190

Forceps jars
Pojemniki na kleszce



Code / Kod	Ø x H mm
SH.755.110	50 x 110
SH.755.130	50 x 130
SH.755.150	50 x 150
SH.755.175	50 x 175

Instrument boxes / Pudełka na instrumenty



Code / Kod	Size / Rozmiar mm		
	A	B	C
SH.010.050	130	50	30
SH.015.080	165	80	30
SH.020.080	180	80	35
SH.020.090	180	90	35
SH.020.100	180	100	35
SH.025.100	200	100	40
SH.025.115	200	115	50

Code / Kod	Size / Rozmiar mm		
	A	B	C
SH.030.050	130	50	30
SH.035.080	165	80	30
SH.040.080	180	80	35
SH.040.090	180	90	35
SH.040.100	180	100	35
SH.045.100	200	100	40
SH.045.115	200	115	50

Cotton containers / Pojemniki do waty



Code / Kod	Ø x H mm
SH.720.075	75 x 75
SH.720.100	100 x 100
SH.720.125	125 x 125
SH.720.150	150 x 150
SH.720.180	180 x 180
SH.720.200	200 x 200



Code / Kod	Size / Rozmiar mm		
	A	B	C
SH.055.100	200	100	40
SH.056.100	200	100	50
SH.056.125	200	125	50
SH.059.125	230	125	60
SH.062.125	250	125	60
SH.062.150	250	150	60
SH.065.150	300	150	60
SH.069.200	505	200	125

Code / Kod	Size / Rozmiar mm		
	A	B	C
SH.075.100	200	100	40
SH.076.100	200	100	50
SH.076.125	200	125	50
SH.079.125	230	125	60
SH.082.125	250	125	60
SH.082.150	250	150	60
SH.085.150	300	150	60
SH.089.200	505	200	125



Sterilization and Sundries Sterylizacja i Inne

Trays kidney shape, standard
Tacki nerki standard



Plastic
Plastikowa

Tray only
Tacka

Lid only
Pokrywa

Code / Kod	Code / Kod	Size / Rozmiar mm
SH.570.150	SH.571.150	150
SH.570.180	SH.571.180	180
SH.570.200	SH.571.200	200
SH.570.250	SH.571.250	250
SH.570.300	SH.571.300	300

Tray only
Tacka

Code / Kod	Size / Rozmiar mm
SH.575.170	170
SH.575.250	250
SH.575.275	275

Tray only
Tacka

Code / Kod	Size / Rozmiar mm
SH.572.200	200
SH.572.280	280

Needle cases / Pudełka na igły



SS.830.000
Complete / Komplet



SS.832.010
65 x 42 x 8 mm



SS.834.010
150 x 90 x 10 mm

Petri dish / Płytki Petri'ego



Code / Kod	Size / Rozmiar mm
LW.061.040	ø40x12mm
LW.061.060	ø60x15mm
LW.061.080	ø80x15mm
LW.061.090	ø90x15mm
LW.061.100	ø100x15mm

Disinfectant tub Wanienka do dezynfekcji



Code / Kod	Outer size Roz zewnętrzne	Inner size Roz wewnętrzne	Pojemność
DZ.1100.01	220 x 150 x 85mm	150 x 125 x 70mm	1L
DZ.1100.02	315 x 206 x 125mm	260 x 175 x 100mm	3L
DZ.1100.03	394 x 260 x 155mm	320 x 215 x 145mm	5L
DZ.1100.04	496 x 328 x 195mm	400 x 270 x 185mm	10L



Bowls type I / Miseczki typ I



Gallipot

Without lid
Bez pokrywki

Code / Kod		Ø mm	H mm
SH.600.010	1 oz	54	29
SH.600.020	2 oz	64	35
SH.600.030	3 oz	70	40
SH.600.040	4 oz	76	44
SH.600.060	6 oz	85	49
SH.600.080	8 oz	90	50
SH.600.090	9 oz	95	57
SH.600.120	12 oz	105	64

(1 oz = 28 ml)

Bowls type II / Miseczki typ II



Lotion

Without lid
Bez pokrywki

Code / Kod	Ø mm
SH.606.040	40
SH.606.060	60
SH.606.080	80
SH.606.090	90
SH.606.100	100
SH.606.100	125
SH.606.125	150
SH.606.150	180
SH.606.180	200
SH.606.200	250
SH.606.250	300
SH.606.300	

Bowls type III / Miseczki typ III



With spout

Code / Kod	Ø mm
SH.610.080	80
SH.610.100	100
SH.610.125	125
SH.610.150	150
SH.610.180	180

Bowls type IV / Miseczki typ IV



Sponge

Code / Kod	Ø mm	H mm
SH.613.105	105	50
SH.613.127	127	60
SH.613.145	145	60
SH.613.165	165	75
SH.613.185	185	85

Bowls type V / Miseczki typ V



Taper style

Code / Kod	Ø mm	H mm
SH.617.080	80	50
SH.617.100	100	55
SH.617.165	165	70
SH.617.175	175	80
SH.617.220	220	95
SH.617.240	240	

Metal re-usable cups /
Kubek wielorazowy metalowy



SH.630.020
ø 77x80mm
180ml

Graduated cups /
Kubki z podziałką



Code / Kod	ml
SH.650.025	25
SH.650.050	50
SH.650.075	75

Iodine cups /
Kubki do jodyny



Code / Kod	oz
SH.640.060	6
SH.640.140	14

(1 oz = 28 ml)

Endometer / Endometr



DZ.580.010
100x40x40mm



Sterilization and Sundries
Sterylizacja i Inne

Endo cleaner
Pojemnik do dezynfekcji instrumentów endodontycznych

Autoclavable
Możliwość sterylizacji w autoklawie



DZ.572.010



DZ.572.040



DZ.572.020
Pink / Różowe



DZ.572.030
Blue / Niebieski

Spare sponges / Gąbeczki



2" dia. x 3/8
(50mm dia. x 8mm)

DZ.572.050
Pack of 48 pieces / Opak. 48 szt.
Ø 50 mm x 8 mm



2 1/2" dia. x 3/8
(65mm dia. x 8mm)

DZ.572.080
Pack of 48 pieces / Opak. 48 szt.
Ø 65 mm x 8 mm

Endometer Ultima / Endometr Ultima



DZ.573.000

Contents:
1 x Endo-Ruler (laser etched)
10 x Disposable medicament cups
3 x Disposable foams

Zawiera:
1 x Endo-Linijkę (laserowo nacinane wymiary)
10 x Kubków jednorazowych na leki
3 x Gąbeczki jednorazowe

DZ.573.020

Disposable foams (pack of 10 pieces)
Gąbeczki jednorazowe (10 szt.)

Spares / Zapasy

DZ.573.010
Disposable medicament cups (pack of 50 pieces)
Kubki jednorazowe na leki (50 szt.)

Endometer laser etched
Endometr na palec, laserowo nacinane wymiary



DZ.575.010



DZ.575.020
Rotatable, suitable for left or right hand
Rotacyjny na lewą lub prawą rękę



DZ.575.000



DZ.573.021

Disposable foams blue (pack of 50 pieces)
Gąbeczki jednorazowe (50 szt.)



DZ.573.001

Endo tray aluminum with cover
Tacka aluminiowa z przykrywką do instrumentów endo



DZ.555.000
257 x 116 x 16 mm

Endo / Implant tray stainless steel with cover
Tacka ze stali nierdzewnej z przykrywką do instrumentów endo i implantów



DZ.556.000
205 x 100 x 25 mm



Transparent endo files stand
Stojak przezroczysty na pilniki



Autoclavable
Możliwość sterylizacji w autoklawie



DZ.564.000 For 10 files / Na 10 pilników

Transparent endo box Mini
Endobox przezroczysty Mini



DZ.564.010
Mini
For 30 files / Na 30 pilników

Transparent endo box Midi
Endobox przezroczysty Midi



DZ.564.020
Midi
For 60 files / Na 60 pilników

Endometer / Endometr



Ø 34x48 mm
DZ.574.010

Aluminum boxes for endodontic instruments / Endoboxy aluminiowe



Autoclavable
Możliwość sterylizacji w autoklawie



Mini
For 20 files / Na 20 pilników

Blue / Niebieski DZ.561.012
Red / Czerwony DZ.561.015



Mini
For 30 files / Na 30 pilników

Blue / Niebieski DZ.561.110
Red / Czerwony DZ.561.111



Midi
For 60 files / Na 60 pilników

Blue / Niebieski DZ.565.210
Red / Czerwony DZ.565.211



Sterilization and Sundries
Sterylizacja i Inne

Aluminum boxes for endodontic instruments / Endoboxy aluminiowe



Autoclavable
Możliwość sterylizacji w autoklawie



Midi
For 72 files / Na 72 pilników

DZ.565.010
Silver / Srebrny



Midi
For 72 files / Na 72 pilników

DZ.565.050
Red / Czerwony



Midi
For 72 files / Na 72 pilników

DZ.565.040
Blue / Niebieski



DZ.567.010
Midi
For 216 files / Na 216 pilników
125 x 105 x 54mm



DZ.569.010
Maxi
For 360 files / Na 360 pilników
204 x 105 x 54mm

Aluminum boxes for endodontic instruments and gutta percha / Endoboxy i pojemniki na gutaperkę aluminiowe



Autoclavable
Możliwość sterylizacji w autoklawie



Blue / Niebieski
Red / Czerwony
DZ.565.220
DZ.565.221



Blue / Niebieski
Red / Czerwony
DZ.561.022
DZ.561.025



Blue / Niebieski
Red / Czerwony
DZ.561.120
DZ.561.121



Cotton rolls dispenser
Pojemnik do wałeczków bawełnianych



Autoclavable
Możliwość sterylizacji w autoklawie



DZ.565.060
Silver / Srebrny



DZ.560.010
Silver / Srebrny



DZ.569.020
Maxi
204 x 105 x 54mm

Nest Universal silicone burs stands with cover
Podstawki silikonowe z pokrywką na wiertła i frezy



Autoclavable
Możliwość sterylizacji w autoklawie

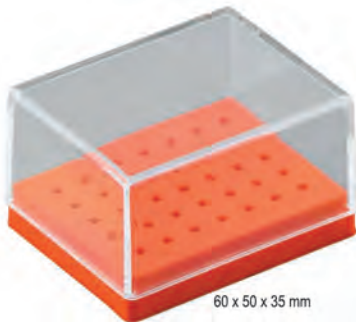

60 x 50 x 35 mm

For 35 FG / RA burs 35mm
Na 35 wiertel FG / RA 35mm

- DZ.064.010 Orange / Pomarańczowa
- DZ.064.020 Red / Czerwona
- DZ.064.030 Yellow / Żółta
- DZ.064.040 Lavender / Lawendowa
- DZ.064.050 Blue / Niebieska
- DZ.064.060 Black / Czarna

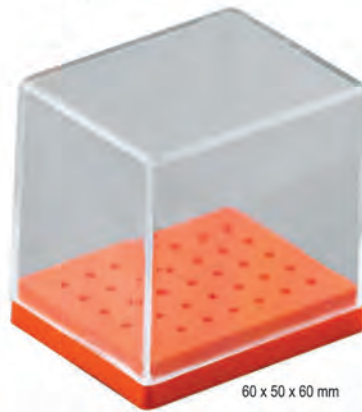

60 x 50 x 60 mm

For 35 HP burs 55mm
Na 35 wiertel HP 55mm

- DZ.064.015 Orange / Pomarańczowa
- DZ.064.025 Red / Czerwona
- DZ.064.035 Yellow / Żółta
- DZ.064.045 Lavender / Lawendowa
- DZ.064.055 Blue / Niebieska
- DZ.064.065 Black / Czarna





Sterilization and Sundries
Sterylizacja i Inne

Magnetic stand for laboratory burs
Magnetyczny stojak na wiertła laboratoryjne



DZ.065.010
Red / Czerwony

Non-autoclavable
Nie można sterylizować w autoklawie

Brass burs stands
Podstawki do wiertel z mosiądzu



135° C Autoclavable
Możliwość sterylizacji w autoklawie

DZ.060.010
FG
for 12 burs
na 12 sztuk

DZ.060.020
CA / RA
for 12 burs
na 12 sztuk

Transparent burs box
Pojemnik przezroczysty do wiertel

135° C Autoclavable
Możliwość sterylizacji w autoklawie



DZ.058.020
FG & CA/RA
for 60 burs / na 60 sztuk

Aluminum burs stands
Podstawki do wiertel aluminiowe

135° C Autoclavable
Możliwość sterylizacji w autoklawie

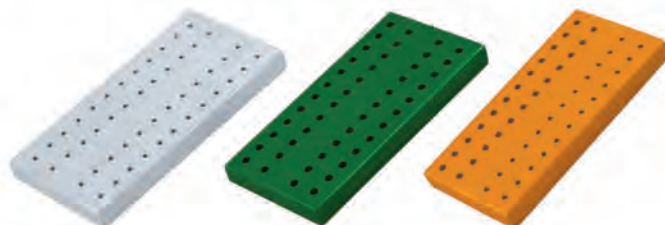

DZ.061.010
FG
for 48 burs / na 48 sztuk

DZ.061.020
CA / RA
for 48 burs / na 48 sztuk

DZ.061.030
FG & CA / RA
for 48 burs / na 48 sztuk

Burs disinfecting box stainless steel
Pojemnik do dezynfekcji wiertel ze stali nierdzewnej



DZ.051.010
Ø 76 mm x H 35 mm

Burs disinfecting box plastic
Pojemnik do dezynfekcji wiertel plastikowy



DZ.050.010
Ø 85 mm x H 70 mm

Mesh burs holder
Koszyczek na wiertła z uchwytem



DZ.052.010
Ø 35mm x L 150 mm

Bur holding tweezers
Penseta do trzymania wiertła



DZ.055.010
165 mm



Aluminum burs stands
Podstawki do wiertel aluminiowe

Aluminum burs stands
Podstawki do wiertel aluminiowe

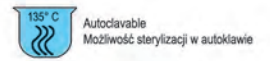

DZ.062.010
FG
60x40 mm
for 24 burs / na 24 sztuki



DZ.062.030
FG & CA / RA
60x40 mm
for 24 burs / na 24 sztuki



DZ.063.010
FG
60x50 mm
for 36 burs / na 36 sztuk



DZ.063.030
FG & CA / RA
60x50 mm
for 36 burs / na 36 sztuk



DZ.062.020
CA / RA
60x40 mm
for 24 burs / na 24 sztuki



DZ.063.020
CA / RA
60x50 mm
for 36 burs / na 36 sztuk

Plastic covers only
Przykrywki plastikowe na podstawki do wiertel

Plastic covers only
Przykrywki plastikowe na podstawki do wiertel



Non-autoclavable
Nie można sterylizować
w autoklawie

60x40x30 mm

DZ.062.000



Non-autoclavable
Nie można sterylizować
w autoklawie

60x50x30 mm

DZ.063.000

Cotton rolls dispenser
Pojemnik do walczków bawełnianych

Cotton rolls holder
Trzymadło do walczków

Cotton pellet dispenser
Pojemnik do kulek z waty

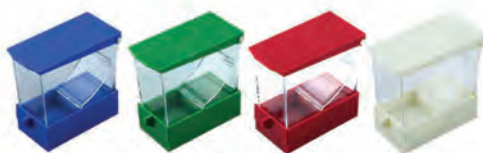

DZ.525.010 Blue / Niebieski
DZ.525.020 Green / Zielony
DZ.525.030 Red / Czerwony
DZ.525.040 White / Biały
DZ.525.050 Yellow / Żółty



DZ.530.010



DZ.532.000
40 x 40 x 50 mm



Sterilization and Sundries
Sterylizacja i Inne

Cotton dispensers stainless steel
Pojemniki do waty ze stali nierdzewnej



DZ.540.010



DZ.540.020

Cotton waste receiver stainless steel
Pojemnik na zużytą watę ze stali nierdzewnej



DZ.544.010

Cotton dispensers aluminum
Pojemniki do waty aluminiowe



DZ.535.010



DZ.535.020



DZ.535.030



DZ.535.040



DZ.535.050

Bibs dispenser
Pojemnik na serwety



DZ.2510.00
205 x 180 x 135 mm



DZ.2510.01
180 x 140 x 135 mm

Drinking cup dispensers
Pojemniki na kubki



DZ.200.010
Silver / Srebrny



DZ.200.020
White / Biały

85 x 85 x 360 mm - for 70 cups / na 70 kubków

Drinking cup dispenser
Pojemnik na kubki



DZ.201.010

Mocowanie - cylinder Ø 40 mm - Ø 60 mm



Handle for acetate sheets
Ergonomiczny uchwyt do folii



DZ.995.000

Sterilizing forceps
Kleszczyki do sterylizacji



SS.920.200
 200mm Collin



SS.907.270
 270mm Cheatle



SS.920.300
 300mm Collin

Towel / Bib chain
Łańcuszek do serwet



DZ.945.020
 Metalowy



DZ.945.050
 Smile Towel / Bib holder
 Łańcuszek gumowy z klipsami w kształcie szczęk



DZ.945.060
 z sprężynką



DZ.945.090
 White / Biały
 z sprężynką



DZ.945.080
 Blue / Niebieski
 z sprężynką



Sterilization and Sundries Steryliczacja i Inne

Protective glasses (Transparent) Okulary ochronne przezroczyste



DZ.9000.01
Clear, Autoclavable
Przeźroczyste, Możliwość
sterylizacji w autoklawie



DZ.9000.05
Clear, Autoclavable
Anti scratch, Anti fog
Przeźroczyste, Możliwość
sterylizacji w autoklawie



DZ.9000.06
Safety Goggle with anti-fog lens,
indirect ventilation system, adjustable
elastic strap

Gogle ochronne przeciwmgielne, wentylacja
pośrednia, regulowany elastyczny pasek
Kolor bezbarwny ,Do użytku zarówno
w pomieszczeniach jak i na zewnątrz
Soczewki PC



DZ.9000.10
Clear, Autoclavable
Anti scratch, Anti fog
Przeźroczyste, Możliwość
sterylizacji w autoklawie



DZ.9000.40
Clear, Autoclavable
Anti scratch, Anti fog
Przeźroczyste, Możliwość
sterylizacji w autoklawie

Protective glasses (Colored) Okulary ochronne kolorowe



DZ.9000.20
Clear, Autoclavable
Anti scratch, Anti fog
Przeźroczyste, Możliwość
sterylizacji w autoklawie



DZ.9000.04
Black for X-ray protection
Okulary czarne, chroniące
przed promieniami RTG



DZ.9000.30
Clear, Autoclavable
Anti scratch, Anti fog
Przeźroczyste, Możliwość
sterylizacji w autoklawie



DZ.9000.02
Yellow, for vision enhancement
Autoclavable
Żółte, dla ochrony wzroku
Możliwość sterylizacji w autoklawie



DZ.9000.03
Orange for use during light curing
Autoclavable
Okulary pomarańczowe do użytku
podczas utwardzania światłem
Możliwość sterylizacji w autoklawie



FACE VISOR

Frame with disposable face shields

Frame:

- Lightweight, secure and comfortable
- Easy-to-fit and secure face shield attachment
- Re-usable, Autoclavable up to 134° C

Disposable face shields:

- Made of polycarbonate, excellent clarity
- Shaped for improved ventilation and full facial coverage
- Protective film on both sides
- Shields clip easily to the frame
- Single use only, do not autoclave or use alcohol to clean shi.



DispoSave
Top Quality @ Fair Price

PRZYŁBICA OCHRONNA

Oprawka z jednorazowymi osłonami foliowymi antystatycznymi

Oprawka:

- Lekka, bezpieczna i wygodna
- Łatwa w montażu, bezpieczne mocowanie osłony foliowej
- Wielokrotnego użytku do sterylizacji w autoklawie do 134° C



Jednorazowe osłony foliowe antystatyczne:

- Wykonane z poliwęglanu, doskonała przejrzystość
- Wyprofilowane dla lepszej wentylacji i pełnego zakrycia twarzy
- Folia ochronna po obu stronach
- Osłony łatwo przypinają się do oprawki
- Produkt jednorazowego użytku, nie można sterylizować ani czyścić środkami zawierającymi alkohol

MADE IN ITALY



FACE VISOR - Frame with disposable face shields

PRZYŁBICA OCHRONNA - Oprawka z jednorazowymi osłonami foliowymi antystatycznymi



DZ.9010.01
Visor-I frame black + 12 face shields
Visor-I Przyłbica ochronna z czarną oprawką + 12 folii



DZ.9010.02
Visor-I frame blue + 12 face shields
Visor-I Przyłbica ochronna z niebieską oprawką + 12 folii



DZ.9010.03
Visor-I frame green + 12 face shields
Visor-I Przyłbica ochronna z zieloną oprawką + 12 folii



DZ.9010.04
Visor-I frame purple + 12 face shields
Visor-I Przyłbica ochronna z purpurową oprawką + 12 folii



Sterilization and Sundries
Sterylizacja i Inne

FACE VISOR-I - Frame with disposable face shields

PRZYŁBICA OCHRONNA-I - Oprawka z jednorazowymi osłonami foliowymi antystatycznymi



DispoSave
Top Quality @ Fair Price



DZ.9010.05
Visor-I frame white + 12 face shields
Visor-I Przyłbica ochronna z białą oprawką + 12 folii



DZ.9010.06
Visor-I frame yellow + 12 face shields
Visor-I Przyłbica ochronna z żółtą oprawką + 12 folii

FACE VISOR-I - Frame only
FACE VISOR-I - Oprawka



DZ.9005.21
Black / Czarna



DZ.9005.22
Blue / Niebieska



DZ.9005.23
Green / Zielona



DZ.9005.24
Purple / Purpurowa



DZ.9005.25
White / Biała



DZ.9005.26
Yellow / Żółta

FACE VISOR - Disposable face shields

PRZYŁBICA OCHRONNA - Jednorazowe osłony foliowe antystatyczne

- High clarity polycarbonate shields
- Shaped for improved ventilation and maximum coverage
- Protective film on both sides
- Scratch resistant
- Latex free

- Wysoka przejrzystość, wykonane z poliwęglanu
- Wyprofilowane dla lepszej wentylacji i pełnego zakrycia twarzy
- Folia ochronna po obu stronach
- Odporne na zarysowania
- Nie zawierają lateksu

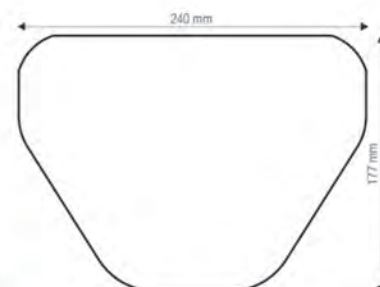

DZ.9010.12
Pack of 12 pieces
Opak. 12 szt



FACE VISOR

Frame with disposable face shields

Frame:

- Lightweight, secure and comfortable
- Easy-to-fit and secure face shield attachment
- Re-usable, Autoclavable up to 121° C

Disposable face shields:

- Made of polycarbonate, excellent clarity
- Shaped for improved ventilation and full facial coverage
- Protective film on both sides
- Shields clip easily to the frame
- Single use only, do not autoclave or use alcohol to clean shields

PRZYŁBICA OCHRONNA

Oprawka z jednorazowymi osłonami foliowymi antystatycznymi

Oprawka:

- Lekka, bezpieczna i wygodna
- Łatwa w montażu, bezpieczne mocowanie osłony foliowej
- Wielokrotnego użytku do sterylizacji w autoklawie do 121° C

Jednorazowe osłony foliowe antystatyczne:

- Wykonane z poliwęglanu, doskonała przejrzystość
- Wyprofilowane dla lepszej wentylacji i pełnego zakrycia twarzy
- Folia ochronna po obu stronach
- Osłony łatwo przypinają się do oprawki
- Produkt jednorazowego użytku, nie można sterylizować ani czyścić środkami zawierającymi alkohol

FACE VISOR - Frame with disposable face shields

PRZYŁBICA OCHRONNA - Oprawka z jednorazowymi osłonami foliowymi antystatycznymi



DispoSave
Top Quality @ Fair Price



MADE IN ITALY



DZ.9011.01
Visor-II frame black + 12 face shields
Visor-II Przyłbica ochronna z czarną oprawką + 12 folii



DZ.9011.02
Visor-II frame blue + 12 face shields
Visor-II Przyłbica ochronna z niebieską oprawką + 12 folii



DZ.9011.03
Visor-II frame green + 12 face shields
Visor-II Przyłbica ochronna z zieloną oprawką + 12 folii



DZ.9011.04
Visor-II frame pink + 12 face shields
Visor-II Przyłbica ochronna z różową oprawką + 12 folii



Sterilization and Sundries
Sterylizacja i Inne

FACE VISOR - Frame with disposable face shields
PRZYŁBICA OCHRONNA - Oprawka z jednorazowymi osłonami foliowymi antystatycznymi



DispoSave
Top Quality @ Fair Price



DZ.9011.05
Visor-II frame violet + 12 face shields
Visor-II Przyłbica ochronna z fioletową oprawką + 12 folii



DZ.9011.06
Visor-II frame white + 12 face shields
Visor-II Przyłbica ochronna z białą oprawką + 12 folii

FACE VISOR - Frame only
FACE VISOR - Oprawka



DZ.9006.21
Black / Czarna



DZ.9006.22
Blue / Niebieska



DZ.9006.23
Green / Zielona



DZ.9006.24
Pink / Różowa



DZ.9006.25
Purple / Fioletowa



DZ.9006.26
White / Biała

FACE VISOR - Disposable face shields
PRZYŁBICA OCHRONNA - Jednorazowe osłony foliowe antystatyczne

- High clarity polycarbonate shields
- Shaped for improved ventilation and maximum coverage
- Protective film on both sides
- Scratch resistant
- Latex free

- Wysoka przejrzystość, wykonane z poliwęglanu
- Wyprofilowane dla lepszej wentylacji i pełnego zakrycia twarzy
- Folia ochronna po obu stronach
- Odporne na zarysowania
- Nie zawierają lateksu

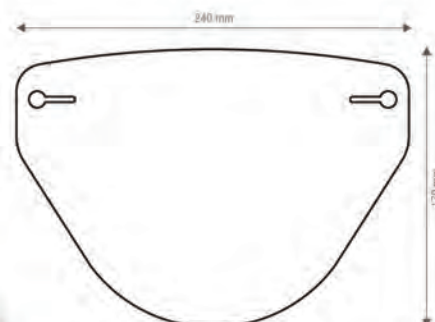

DZ.9011.12
Pack of 12 pieces
Opak. 12 szt



**Protective face shields
Przybicie ochronne**

Charakteryzują się lekką konstrukcją oraz wysoką ergonomią. Szybka osłona wykonana jest z poliwęglanu i spełnia wymagania polskich i europejskich norm w zakresie parametrów mechanicznych oraz optycznych dla I klasy wykonania. Osłona stomatologiczna OL-75/S znajduje swoje zastosowanie w gabinetach stomatologicznych, placówkach służby zdrowia, lecznicach dla zwierząt oraz wszędzie tam, gdzie higiena jest niezbędnym elementem pracy.



DZ.9004.01
190 mm x 345 mm

FACE VISOR
Headband with disposable face shields

HEAD BAND

- Lightweight, secure and comfortable
- One size fits all with adjustable strap
- Easy-to-fit and secure face shield attachment
- Re-usable, Autoclavable up to 121° C



Flips up out of your way when needed, ideal for longer wear.



Can be worn over glasses or loupes.



DZ.9013.12 Refill face shields 12 pieces
250 x 180mm Folie antystatyczne do przybicy 12 szt.



DZ.9013.01
250 x 180mm

**Disposable protective face shield
Jednorazowa przybicia ochronna**

Each / Sztuka



DZ.9004.04
320 x 220mm

**Light protection hand shield
Osłona ochronna do lampy polimeryzacyjnej**



Autoclavable
Możliwość sterylizacji w autoklawie



DZ.9003.01
125 x 260 x 3mm
Orange / Pomarańczowa

**Protective face shields
Przybicie ochronne**



DZ.9006.00
Refill face shields 10 pieces
Folie antystatyczne do przybicy 10 szt.



DZ.9006.01
Blue frame + 10 face shields
Przybicia ochronna niebieska + 10 sztuk folii

**Magnifying glasses
Okulary powiększające**



DZ.9020.01 2.5 x
DZ.9020.02 3.5 x

Light, practical and high visual performance, the magnifying lens is indispensable to enhance visualization in direct and/or indirect procedures.

- Ophthalmic lenses with 2.5 or 3.5x magnification.



Ergonomia para o professional

**Mortar and pestle
Moździerz i tłuczek szklane**



DZ.9950.00

**Glass dappen pots
Kieliszki szklane**

Each / Sztuka

- DZ.8505.01 Blue / Niebieski
- DZ.8505.02 Clear / Przezroczysty
- DZ.8505.03 Green / Zielony
- DZ.8505.05 Brown / Brązowy





Sterilization and Sundries Sterylizacja i Inne

Glass medicament bottles Buteleczka szklana na medykamenty

Each / Sztuka



DZ.8510.02
Clear / Przezroczysty



DZ.8510.04
Brown / Brązowy



DZ.8510.06
Rose / Różowy



DZ.8510.03
Green / Zielony



DZ.8510.05
Blue / Niebieski



DZ.8510.07
Yellow / Żółty



DZ.8510.00
Glass bottle set with stand
Zestaw szklanych buteleczek ze stojakiem



DZ.8510.08
Glass bottle set without stand 5 pieces
Zestaw szklanych buteleczek bez stojak 5 szt.

Color coding tape Kolorowe taśmy do oznaczania instrumentów



6.35 mm wide, 5 meters spool / Szerokość 6.35 mm, szpula 5m



Autoclavable
Możliwość sterylizacji w autoklawie

DZ.078.010	Black / Czarna	DZ.078.050	Orange / Pomarańczowa
DZ.078.020	Blue / Niebieska	DZ.078.060	Red / Czerwona
DZ.078.030	Brown / Brązowa	DZ.078.070	White / Biała
DZ.078.040	Green / Zielona	DZ.078.080	Yellow / Żółta

Aspirator cleaning brushes Czyszcik do aspiratora



Autoclavable
Możliwość sterylizacji w autoklawie



DZ.5005.05 X-Fine \varnothing 5 x 165mm

DZ.5005.08 Fine \varnothing 8 x 170mm

DZ.5005.14 Medium \varnothing 14 x 225mm

DZ.5005.20 Large \varnothing 20 x 225mm

Color coding rings Kolorowe kółka silikonowe do oznaczenia instrumentów

Key Features:
Made of medical grade silicone
Available in two sizes:
Small: inner \varnothing 4mm
Large: inner \varnothing 6mm

Cechy:
Wykonane z silikonu medycznego
Dostępne w 2 rozmiarach:
Małe: wew. \varnothing 4 mm
Duże: wew. \varnothing 6 mm



Small / Małe

Color / Kolor	Code / Kod	Pack / Opak.
Assorted / Mix kolorów	DZ.080.001	450 szt.
Assorted / Mix kolorów	DZ.080.000	50 szt.
Black / Czarna	DZ.080.010	50 szt.
Dark blue / Ciemnoniebieskie	DZ.080.020	50 szt.
Light blue / Jasnyniebieskie	DZ.080.030	50 szt.
Brown / Brązowe	DZ.080.050	50 szt.
Grey / Szare	DZ.080.080	50 szt.
Green / Zielone	DZ.080.090	50 szt.
Orange / Pomarańczowe	DZ.080.110	50 szt.
Pink / Różowe	DZ.080.130	50 szt.
Red / Czerwone	DZ.080.150	50 szt.
White / Białe	DZ.080.170	50 szt.
Yellow / Żółte	DZ.080.180	50 szt.

Pack of 50 pieces
Opak. 50 szt.

Pack of 450 pieces
Opak. 450 szt.

Large / Duże

Color / Kolor	Code / Kod	Pack / Opak.
Assorted / Mix kolorów	DZ.081.001	225 szt.
Assorted / Mix kolorów	DZ.081.000	50 szt.
Black / Czarna	DZ.081.010	50 szt.
Dark blue / Ciemnoniebieskie	DZ.081.020	50 szt.
Light blue / Jasnyniebieskie	DZ.081.030	50 szt.
Brown / Brązowe	DZ.081.050	50 szt.
Grey / Szare	DZ.081.080	50 szt.
Green / Zielone	DZ.081.090	50 szt.
Orange / Pomarańczowe	DZ.081.110	50 szt.
Pink / Różowe	DZ.081.130	50 szt.
Red / Czerwone	DZ.081.150	50 szt.
White / Białe	DZ.081.170	50 szt.
Yellow / Żółte	DZ.081.180	50 szt.

Pack of 50 pieces
Opak. 50 szt.

Pack of 225 pieces
Opak. 225 szt.

www.falconmedical.pl

D₁₈

Veterinary instruments for small animals / Instrumenty weterynaryjne dla małych zwierząt



Falcon[®]
Medical Polska
Your Instruments since 1975





Dental instruments for cats and dogs / Instrumenty stomatologiczne dla kotów i psów

Diagnostic and restraint / Diagnostyka i akcesoria do pyska

Mouth gags for cats and dogs / Rozwieraki dla kotów i psów



Grays
For cats / Dla kotów

DV.003.030	30 mm
DV.003.055	55 mm
DV.003.075	75 mm

Mouth gag Gray plastic inserts
Wymienne końcówki plastikowe do rozwieraka Gray



Pack of 12 pcs
Opak 12 szt.

DV.002.000



Grays
For dogs / Dla psów

DV.007.115	115 mm
DV.007.145	145 mm
DV.007.180	180 mm



Smith-Baxter
For dogs / Dla psów

DV.010.055	55 mm
DV.010.065	65 mm
DV.010.100	100 mm
DV.010.140	140 mm
DV.010.150	150 mm

Lip retractor for dogs / Rozwierak do warg dla psa



DV.015.165
165 mm

Mirrors and handle / Lusterka i uchwyt



120 mm

Fig.	Ø	Plane / Plaskie
0	10 mm	FB.009.010
1	12 mm	FB.009.012
2	14 mm	FB.009.014
3	16 mm	FB.009.016
4	18 mm	FB.009.018
5	20 mm	FB.009.020
6	22 mm	FB.009.022
7	24 mm	FB.009.024
8	26 mm	FB.009.026
9	28 mm	FB.009.028
10	30 mm	FB.009.030



FB.010.110
110 mm



Dental instruments for cats and dogs / Instrumenty stomatologiczne dla kotów i psów

Extraction / Ekstrakcja

Elevators for cats and dogs / Dźwignie dla kotów i psów

Falcon - Winged

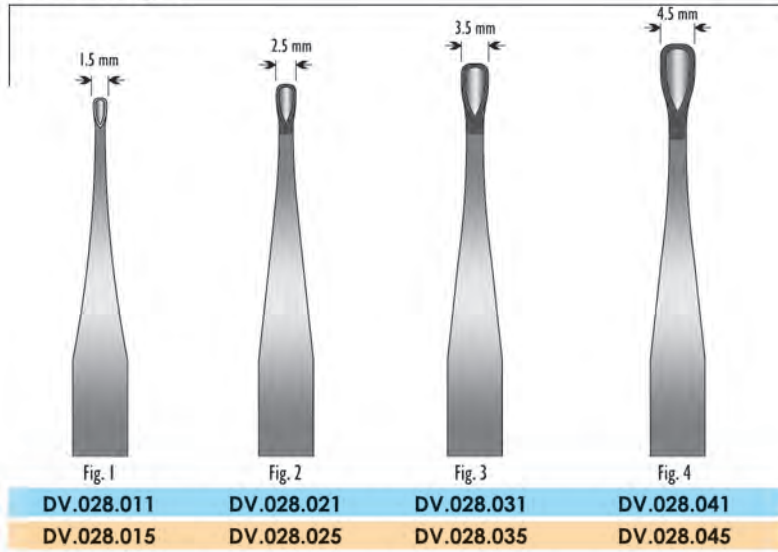

Falcon - Winged Modified

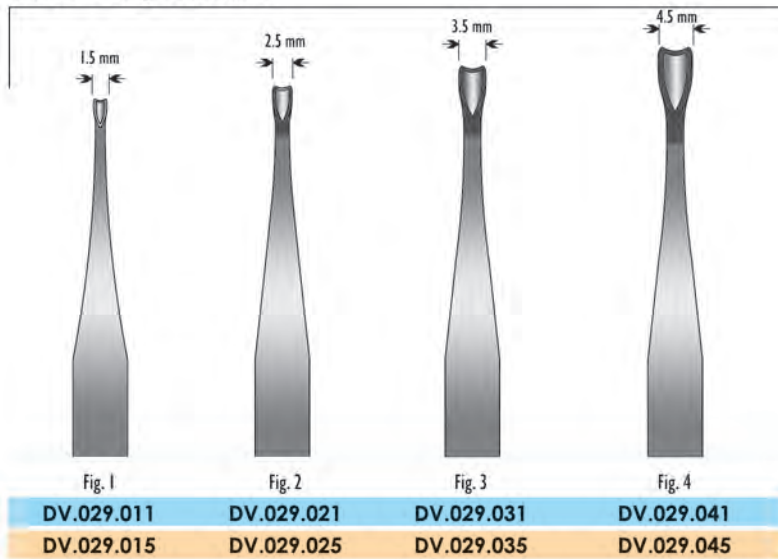

Standard Handle / Uchwyt



Slim Handle / Uchwyt

Feline



Coupland - Vet

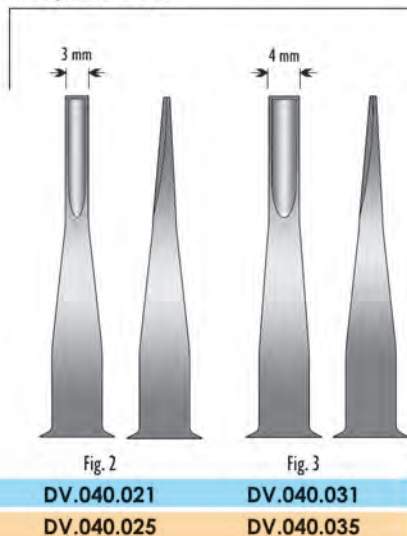



Dental instruments for cats and dogs / Instrumenty stomatologiczne dla kotów i psów

Extraction / Ekstrakcja

Elevators for cats and dogs / Dźwignie dla kotów i psów

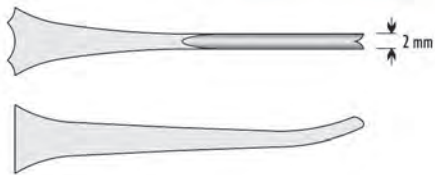

Fig. 1
DV.060.019
Lower for cats / Dolna dla kotów



Fig. 2
DV.060.029
Upper for cats / Górna dla kotów

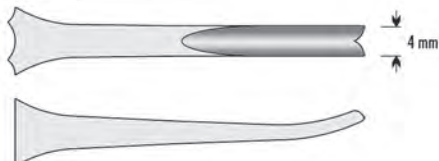

Fig. 1
DV.061.019
Lower for dogs / Dolna dla psów

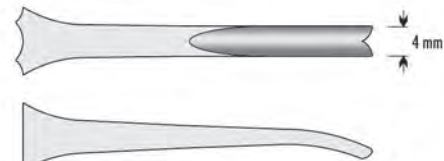

Fig. 2
DV.061.029
Upper for dogs / Górna dla psów



DV.075.010
Elevator root / Dźwignia korzeniowa



DV.080.010
Wedge Elevator / Dźwignia klinowa



2 mm **DV.090.017** 3 mm
Mini periosteal elevator / Mini elewatorium



Dental instruments for cats and dogs / Instrumenty stomatologiczne dla kotów i psów

Extraction / Ekstrakcja

Extraction forceps for cats / Kleszcze ekstrakcyjne dla kotów



DV.108.120



DV.110.160



DV.112.155



Extraction forceps for dogs / Kleszcze ekstrakcyjne dla psów



Fig. 15
DE.300.150
Lower molars
Do zębów trzonowych dolnych



Fig. 150
DE.301.500
Upper incisors, canines, premolars and roots
Do zębów przednich, przedtrzonowych i korzeni górnych



Fig. 151
DE.301.510
Lower incisors, canines, premolars and roots
Do zębów przednich, przedtrzonowych i korzeni dolnych



Fig. 101
DE.301.010
Upper and lower premolars
Do zębów przedtrzonowych górnych i dolnych



Dental instruments for cats and dogs / Instrumenty stomatologiczne dla kotów i psów

Hygiene / Higiena

Scalers single ended / Sierpy jednostronne



Scharman

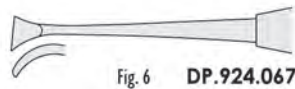
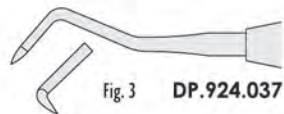
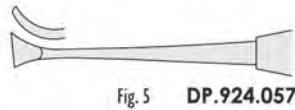
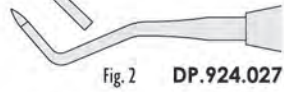
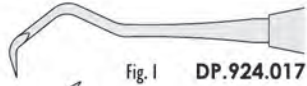

DP.924.000
Set of 6 pieces
Zestaw 6 szt.

Falcon

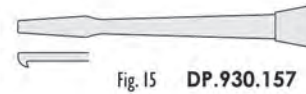

Scalers double ended / Sierpy dwustronne

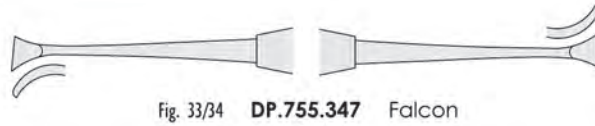

Curette double ended / Kireta dwustronna



Fig. 7/8 DP.160.089 Gracey - Vet

Tartar removal forceps
Kleszcze do usuwania kamienia nazębnego



DV.150.010 Small / Małe
DV.150.020 Large / Duże



Dental instruments for cats and dogs / Instrumenty stomatologiczne dla kotów i psów
Endodontics / Endodoncja

Pluggers and spreaders / Upychadła i poszerzaczce

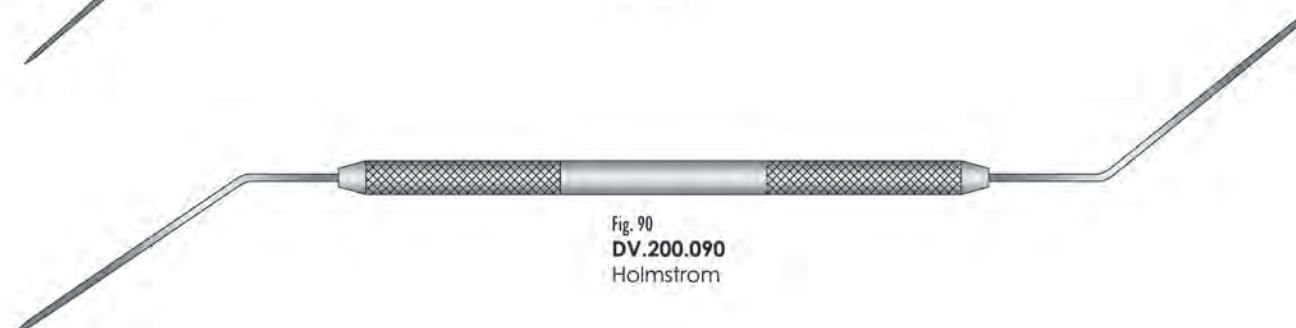
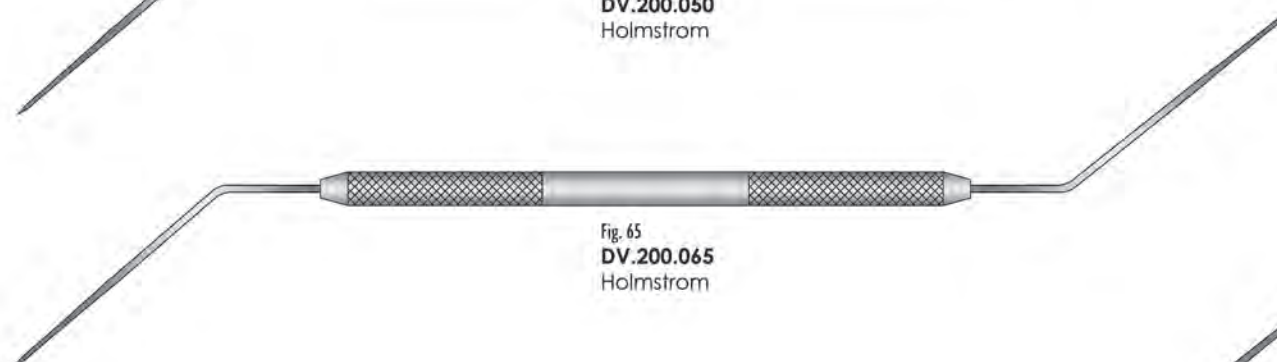
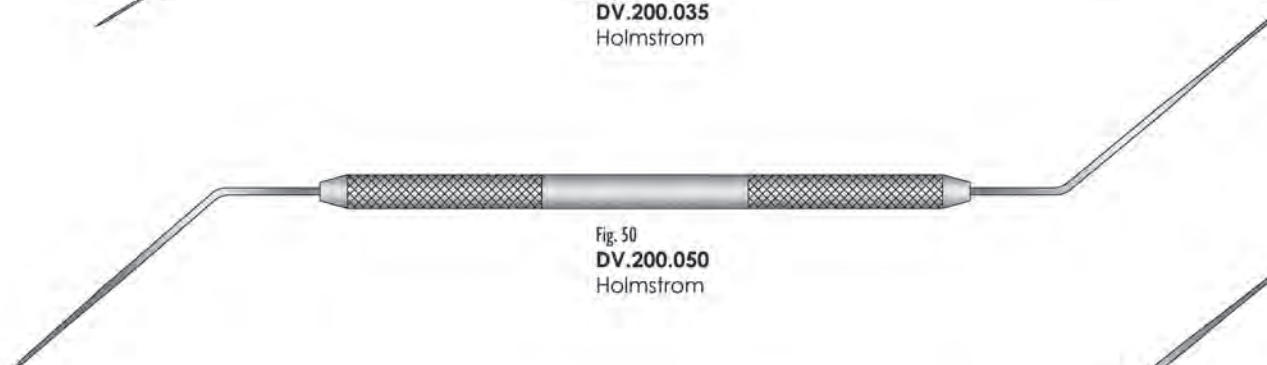



Dental instruments for rodents / Instrumenty stomatologiczne dla gryzoni

Diagnostic and restraint / Diagnostyka i akcesoria do pyska

Rodent/Rabbit dental table / Stolik stomatologiczny dla gryzoni / królików



Falcon
DV.300.00
240 x 130 x 25 mm

Mouth gags / Rozwieraki



Falcon
DV.310.115
115 mm



Falcon
DV.313.115
115 mm



Falcon
DV.320.130
130 mm



Falcon
DV.322.095
95 mm



Dental instruments for rodents / Instrumenty stomatologiczne dla gryzoni

Diagnostic and restraint / Diagnostyka i akcesoria do pyska

Cheek retractors / Rozwieraki do policzków

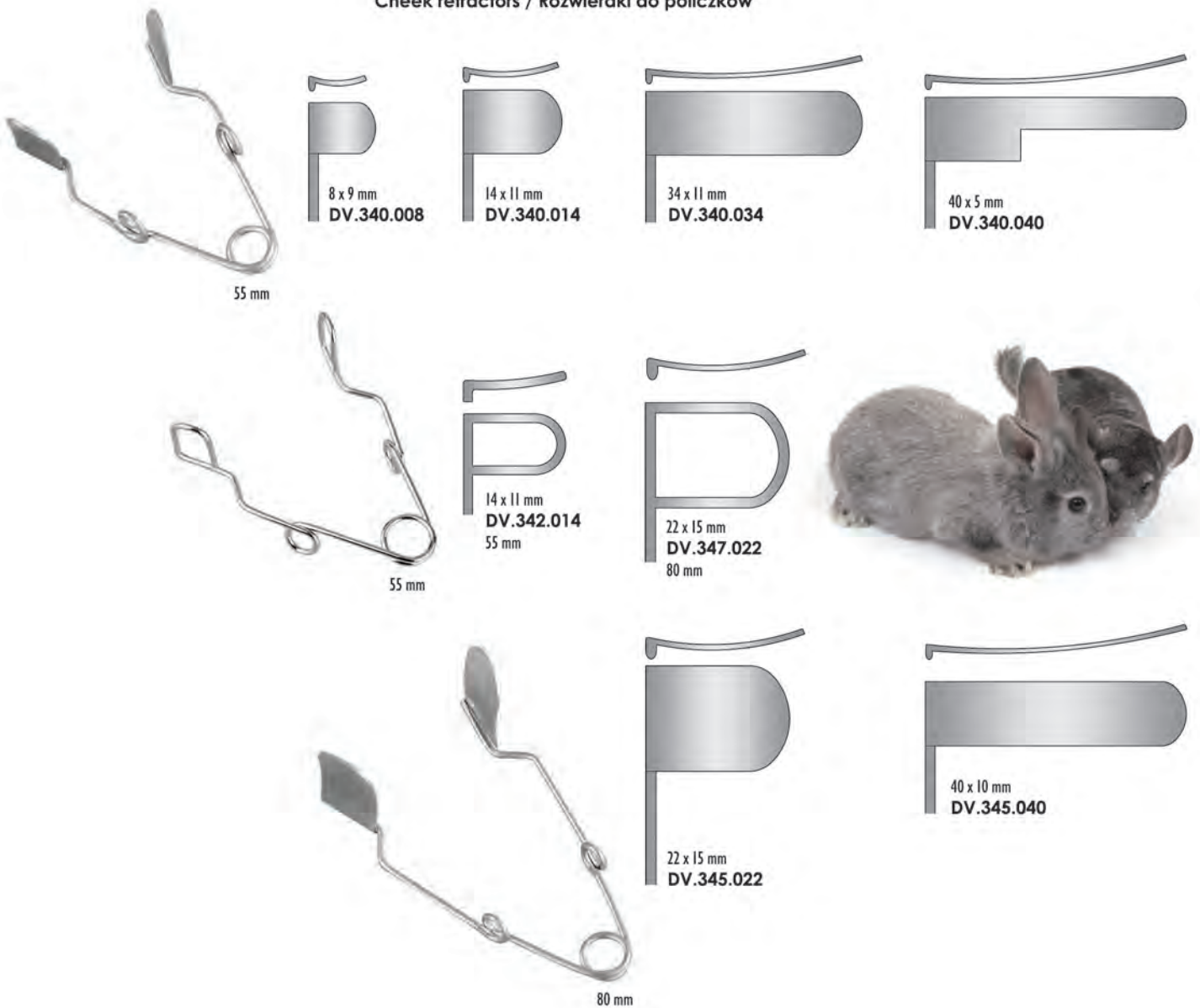

Mouth examination spatulas and tongue depressors / Szpatułki diagnostyczne i łopatki do języka

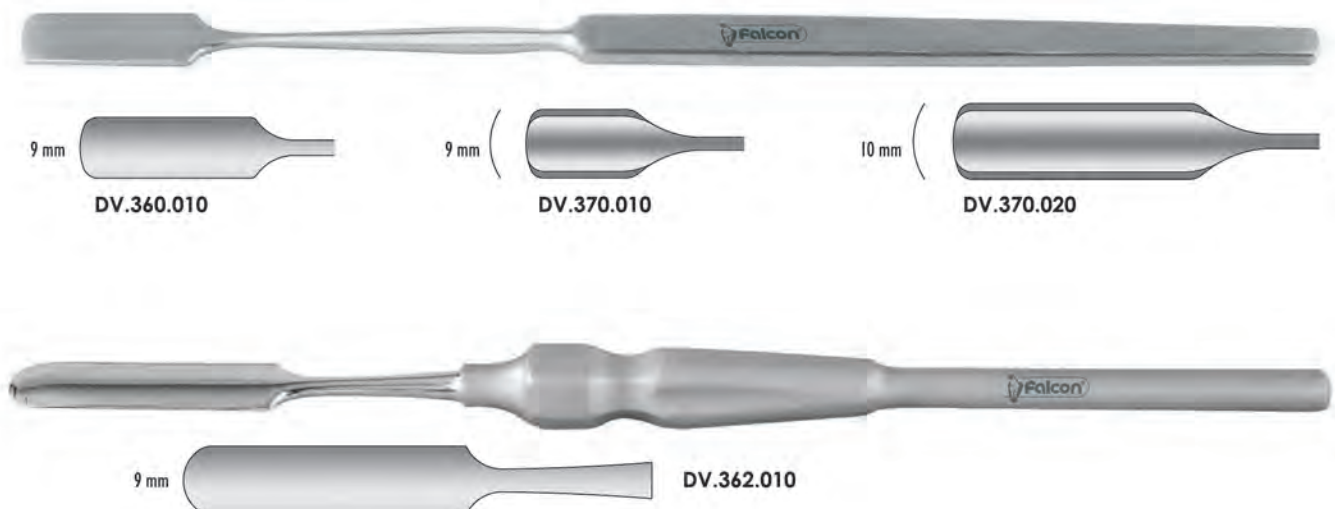



Dental instruments for rodents / Instrumenty stomatologiczne dla gryzoni

Extraction / Ekstrakcja

Tooth rasps / Skrobaczki do zębów



Fig. 1 DV.400.010 180 mm

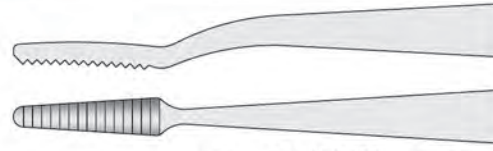

Fig. 2 DV.400.020 180 mm

Luxators / Dźwignie Luksatory



Fig. 1 DV.410.010 Incisors / Do siekaczy

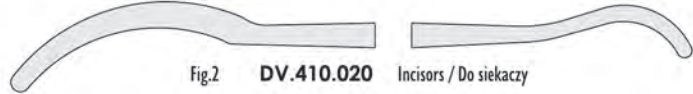

Fig. 2 DV.410.020 Incisors / Do siekaczy

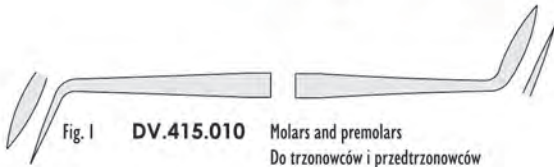

Fig. 1 DV.415.010 Molars and premolars
Do trzonowców i przedtrzonowców

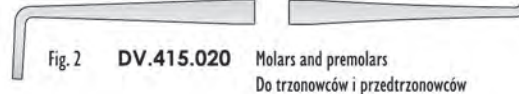

Fig. 2 DV.415.020 Molars and premolars
Do trzonowców i przedtrzonowców

Extraction forceps / Kleszcyki ekstrakcyjne



DV.430.155
155 mm
Molars and premolars
Do trzonowców i przedtrzonowców



Falcon
GRIP
With tungsten carbide inserts
Con punte al carburo di tungsteno
Z wkładką z węgla spiekanego

DV.432.160
160 mm
Molars and premolars
Do trzonowców i przedtrzonowców

Tooth cutter / Kleszcze do przycinania zębów



DV.440.185
185 mm
Molars and premolars
Do trzonowców i przedtrzonowców



DV.442.180
180 mm
Molars and premolars
Do trzonowców i przedtrzonowców

D19

Rotary instruments / Instrumenty rotacyjne





Prophy brushes RA / Szczoteczki do polerowania na kątnice

max. 10'000 rpm

For polishing and cleaning of natural teeth, gold, amalgam fillings and removing plaque stains. Use with prophylaxis paste.

Czyszczą i polerują zęby, złoto, wypełnienia amalgamatowe oraz redukują płytkę nazębną. Szczoteczki do profilaktyki z zastosowaniem pasty polerskiej.

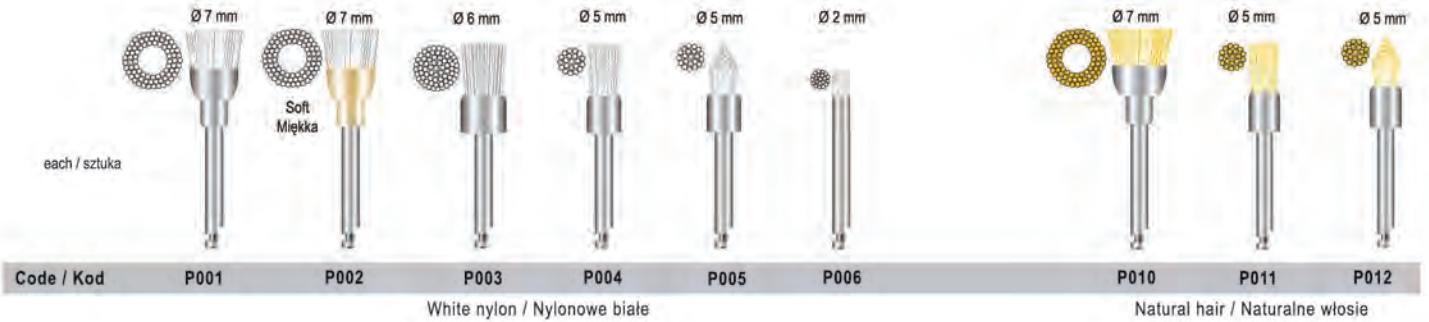

SMART

max. 10'000 rpm

Color coded prophy brushes RA / Szczoteczki do polerowania z kolorowego nylonu na kątnice

For polishing and cleaning stains caused by coffee, tea, nicotine, red wine. Use with prophylaxis paste.

Polerują i czyszczą zęby z kamienia i osadów z kawy, herbaty, tytoniu oraz czerwonego wina. Szczoteczki do profilaktyki z zastosowaniem pasty polerskiej.

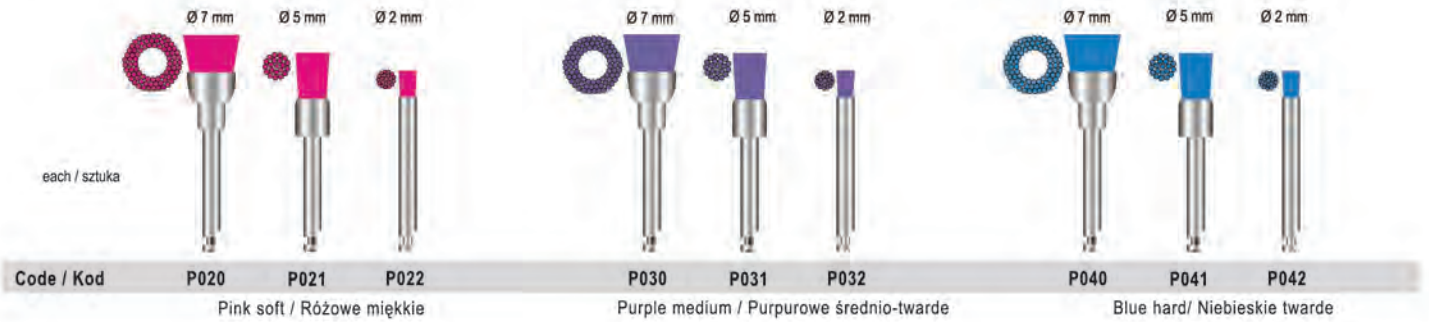

SMART

max. 10'000 rpm

Color coded prophy cups latex free RA / Gumki do polerowania bez lateksu na kątnice

Use with prophylaxis paste / Używać z pastą polerską

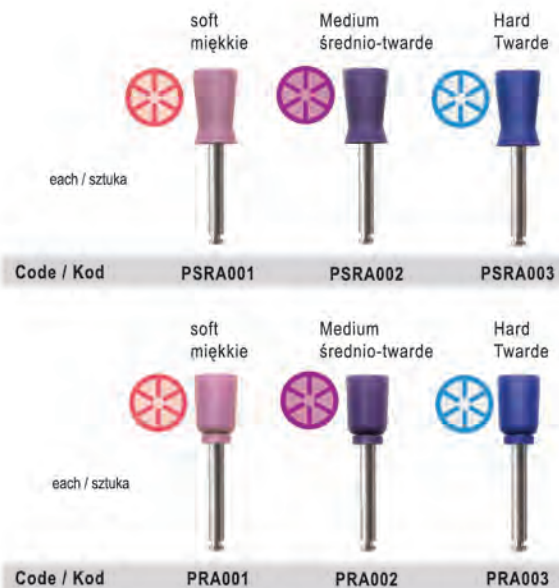

Prophylaxis pastes 1.23 % fluoride, mint flavoured / Pasty polerskie z fluorem 1.23%, miętowe

Pack of 200 single 2 g dose and 1 prophy ring
Opak. 200 kapsulek po 2 g i 1 uchwyt do aplikacji pasty



ST-PAS007 Medium / Średnioziarnista
ST-PAS008 Coarse / Gruboziarnista



Prophylaxis pastes fluoride free, mint flavoured / Pasty polerskie bez fluoru, miętowe

Made of 100% natural ingredients.
Zawierają 100% naturalnych składników.

PAS001 Medium / Średnioziarnista



Jar / Słoiczek
50 g.



DIA-DUPLEX

Diamond polishers latex free / Diamentowe gumki do polerowania bez lateksu

Synthetic rubber polishers with impregnated diamond grit.
A two-step polishing system for: composites, ceramic, compomer and glassionomer.

Syntetyczne gumki impregnowane diamentem do polerowania.
Dwustopniowy system do polerowania kompozytów, ceramiki, kompomerów i glasonomerów.

max. 15'000 rpm



SET1012
Set of 8 pieces, one of each type
Zestaw 8 gumek po jednej z rodzaju

each / sztuka



Code / Kod	DP101	DP102	DP103	DP104	DP111	DP112	DP113	DP114
L mm	7,0	10,0	8,3	2,5	7,0	10,0	8,3	2,5
Ø mm	3,3	5,2	6,0	10,0	3,3	5,2	6,0	10,0

Step 1 - Polishing / Stopień 1 - Polerowanie pośrednie

Step 2 - Fine polishing / Stopień 2 - Polerowanie ostateczne

DIA-COMP

Diamond polishers latex free / Diamentowe gumki do polerowania bez lateksu

Synthetic rubber polishers with impregnated diamond grit.
A three-step polishing system for: composites (micro, hybrid, macro), compomer and glassionomer.

Syntetyczne gumki impregnowane diamentem do polerowania.
Trzystopniowy system do polerowania kompozytów (mikrocząsteczkowych, hybrydowych, makrocząsteczkowych), materiałów kompomerowych i glasonomerowych.

max. 15'000 rpm

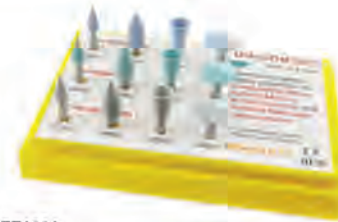

SET1001
Set of 12 pieces, one of each type
Zestaw 12 gumek po jednej z rodzaju

each / sztuka



Code / Kod	DP031	DP032	DP033	DP034	DP041	DP042	DP043	DP044	DP051	DP052	DP053	DP054
L mm	7,0	10,0	8,3	2,5	7,0	10,0	8,3	2,5	7,0	10,0	8,3	2,5
Ø mm	3,3	5,2	6,0	10,0	3,3	5,2	6,0	10,0	3,3	5,2	6,0	10,0

Step 1 - Pre-polishing
Stopień 1 - Polerowanie wstępne

Step 2 - Polishing
Stopień 2 - Polerowanie pośrednie

Step 3 - Fine polishing
Stopień 3 - Polerowanie ostateczne

Use with spray coolant / Używać ze sprayem chłodzącym

Arkansas stones / Kamienie Arkansas

White "Arkansas" abrasives, extra fine, for smooth grinding and polishing of filling materials and composite-filling materials

Białe kamienie drobnocząsteczkowe do szlifowania i polerowania materiałów wypełnieniowych w tym kompozytowych.

max. 130'000 rpm

each / sztuka



Code / Kod	ST-601RA	ST-612RA	ST-638RA	ST-645RA	ST-649RA	ST-661RA	RA / Na kątnicę
Code / Kod	ST-601FG	ST-612FG	ST-638FG	ST-645FG	ST-649FG	ST-661FG	FG / Na turbinę
L mm	3,0	3,0	6,0	7,0	7,0	7,0	
Ø mm	3,0	3,0	3,0	3,0	2,7	3,0	



SET5001
Set of 6 pieces, one of each type RA
Zestaw 6 kamieni po jednym z rodzaju na kątnicę



SET5002
Set of 6 pieces, one of each type FG
Zestaw 6 kamieni po jednym z rodzaju na turbinę



Rotary instruments Instrumenty rotacyjne

Polishers latex free / Gumki do polerowania bez lateksu

Synthetic rubber polishers for amalgam and metals.
A three-step polishing system for amalgam, precious and non-precious metal alloys.

Syntetyczne gumki do polerowania amalgamatu i metali.
Trzystopniowy system do polerowania amalgamatu oraz stopów metali szlachetnych i nieszlachetnych.

max. 20'000 rpm



SET1003
Set of 10 pieces, one of each type
Zestaw 10 gumek po jednej z rodzaju

each / sztuka



Code / Kod	S121	S122	S132	S133	S134	S135	S141	S142	S143	S144
L mm	6,0	9,0	6,0	10,0	9,0	2,5	6,0	10,0	9,0	2,5
Ø mm	3,3	6,5	3,3	5,2	6,5	10,0	3,3	5,2	6,5	10,0

Step 1 - Rough grinder
Stopień 1 - Szlifowanie wstępne

Step 2 - Pre-polishing
Stopień 2 - Polerowanie wstępne

Step 3 - Highshine polishing
Stopień 3 - Polerowanie na wysoki połysk

COMPO Polishers latex free / Gumki do polerowania bez lateksu

Silicone polishers for satin finish.
A single step polishing system for composite materials and natural teeth.

Silikonowe gumki do polerowania pozwalające uzyskać jedwabistą powierzchnię.
Jednostopniowy system do polerowania materiałów kompozytowych i naturalnych zębów.

max. 10'000 rpm

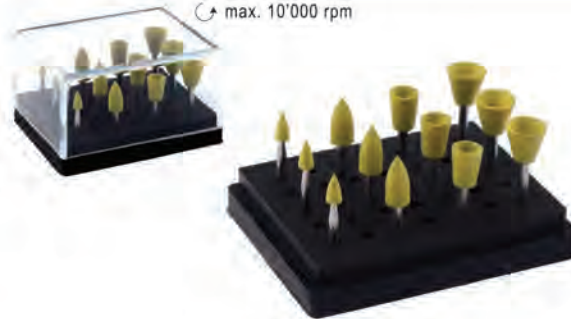

SET1004
Set of 12 pieces, three of each type
Zestaw 12 gumek po trzy z rodzaju

each / sztuka

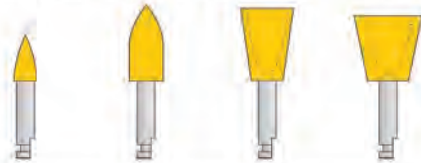

Code / Kod	S151	S152	S153	S154
L mm	6,0	10,0	9,5	8,5
Ø mm	3,3	5,2	7,0	9,0

Disposable prophylaxis cups and brushes Jednorazowe gumki i szczoteczki

Pack of 100 pieces / Opak. 100 szt.



DH.5010.01
Regular / Standardowe



DH.5010.02
Soft / Miękkie



DH.5010.03
Standard brush
Szczoteczka standardowa

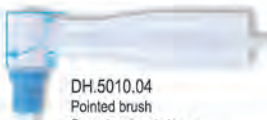

DH.5010.04
Pointed brush
Szczoteczka stożkowa

Polyester abrasive polishing tape Taśma poliestrowa ścierna



15 mb ± 5 cm Length / Długość

DR.1200.20	Fine grit, 8 mm x 20 µ (niebieska)
DR.1200.60	Medium grit, 8 mm x 60 µ (zielona)
DR.1200.90	Coarse grit, 8 mm x 90 µ (czerwona)

S-FLEX polishing discs Krażki ściernie do opracowania i polerowania wypełnień



Pack of 25 pieces / Opak. 25 szt

Code / Kod	Type / Typ
DR.1310.00	Yellow, Extra thin fine grit / Żółty, drobne ziarna ściernie
DR.1320.00	Pink, Extra thin medium grit / Różowy, średnie ziarna ściernie
DR.1340.00	Blue, Medium grit / Niebieski, średnie ziarna ściernie
DR.1380.00	Brown, Coarse grit / Brązowy, grube ziarna ściernie

Mandrel for S-FLEX polishing discs Trzymadło do S-FLEX



DR.1311.00



Polishing wheels mounted HP / Krążki i szczotki polerskie montowane na mandryli na prostnicę

max. 10'000 rpm

Cotton and calico wheels for high shine polishing of plastic prosthetics, composites, crown and bridge work made of precious and non precious metal and CrCo.

Felt wheels for polishing of ceramics and composites

each / sztuka

Krażki bawełniane i płócienne (baranki) do polerowania na wysoki połysk akrylu, metali, kompozytu, stopów metali szlachetnych i nieszlachetnych, chromu, kobaltu.

Krażki filcowe do polerowania ceramiki i kompozytów.



Materials	Cotton yarn	Calico	Felt soft 3 folds	Solid felt hard	Solid felt knife edge hard
Materiały	Bawełniana przędza	Perkal	Filc miękki, 3 warstwy	Filc twardy	Filc twardy z ostrym brzegiem
Code / Kod	PB-001	PB-002	PB-003	PB-004	PB-005

White bristle and horse hair wheels for polishing of composite materials, crown and bridge work, precious metal and chrome cobalt with polishing paste.

Nylon brush for cleaning prosthetics

Szczotki polerskie impregnowane pastą polerską z białym lub końskim włosiem do polerowania materiałów kompozytowych, koron i mostów, stopów metali szlachetnych i chromowo-kobaltowych.

Szczotka nylonowa do czyszczenia prac protezycznych (do usuwania resztek gipsu z przestrzeni międzyzębowych)



Materials	White bristle stiff	Grey/white horse hair	White nylon
Materiały	Włosie białe sztywne	Włosie końskie szaro-białe	Nylon biały
Code / Kod	PB-006	PB-007	PB-008

ALPINE Polishing brushes mounted HP / Szczotki polerskie montowane na trzymadélku na prostnicę

For polishing of precious metal alloys, acrylic teeth, non precious metal alloys, hard alloys, composite, ceramics. Use with prophylaxis paste.

Polerują stopy metali szlachetnych i nieszlachetnych, zęby akrylowe, kompozyt i ceramikę. Używać z pastą polerską.



Code / Kod	APB-001	APB-002	APB-003	APB-004
-------------------	----------------	----------------	----------------	----------------

Horse hair hard / Włosie końskie twarde



Code / Kod	APB-005	APB-006	APB-007	APB-008
-------------------	----------------	----------------	----------------	----------------

Goat/horse hair medium / Włosie kozie i końskie średnio-twarde

Slimline plastic & metal centre brushes

Slimline brushes for polishing of hard alloys, chrome cobalt, acrylic and chrome cobalt dentures

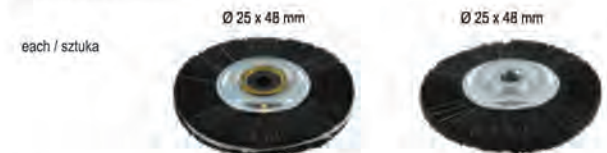

Materials	Horse hair extra stiff	Horse hair extra stiff
Materiały	Włosie końskie bardzo sztywne	Włosie końskie sztywne
Code / Kod	MCP005	MCP001

Chamois mop

Finest chamois mop with plastic center for high shine polishing of prosthetic plastic and metals.



Materials	Chamois
Materiały	Chamois
Code / Kod	MOP036



Polishing mops / Szmaciaki polerskie

For polishing plastic prosthetics, composites, crown and bridge work made of precious, non precious metal and chrome cobalt to a high finish.
Przeznaczone do polerowania na wysoki połysk akrylu, kompozytów, metali, stopów szlachetnych, nieszlachetnych i chromowo-kobaltowych.

max. 2'800 rpm

each / sztuka

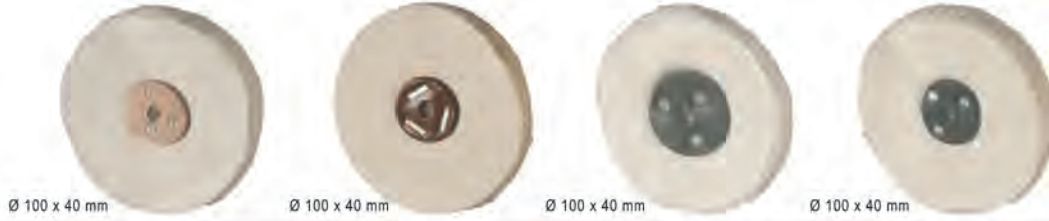

Materials, Folds	Calico swansdown, 14 folds	Calico medium, 25 folds	Calico stiff, 25 folds	Calico fine weave, 30 folds
Materiały, Warstwy	Perkal bardzo miękki, 14	Perkal średnio-twardy, 25	Perkal sztywny, 25	Perkal drobno tkany, 30
Code / Kod	CM003C	CM007	CM008	CM009

Polishing mop / Szmaciak polerski

For pre- and high shine polishing of plastic prosthetics and high shine polishing of all kinds of metals.
Przeznaczony do polerowania wstępnego i na wysoki połysk akrylu oraz wszystkich rodzajów metali.

max. 2'800 rpm

each / sztuka



Ø 105 x 40 mm

MOP037

Pure white cotton, 40 folds, plastic centre
Czysta bawełna biała, 40 warstw, środek plastikowy

Felt polishers hard HP / Filce polerskie twarde na prostnicę

Felt Cones for polishing composites and ceramics with diamond polishing paste.
Impregnowane diamentową pastą polerską. Przeznaczone do polerowania kompozytów i ceramiki.

max. 16'000 rpm

each / sztuka



Ø x L mm	10 x 15	9 x 12	8 x 16	10 x 14	14 x 15	11 x 20
Code / Kod	TPF002	TPF003	TPF005	TPF007	TPF008	TPF010

Felt polishers / Filce polerskie (krążki i palce)

Felt Cones for polishing composites and ceramics with diamond polishing paste.
Impregnowane diamentową pastą polerską. Przeznaczone do polerowania kompozytów i ceramiki.

max. 2'800 rpm

each / sztuka



Code / Kod	CDTP008C	CDTP007C	CDTP006C	FC003	FC004	FC005
	Soft / Miękkie	Hard / Twarde		Hard / Twarde		

Artist brushes / Pędzle Kolinsky

High quality round sable brushes for dental and ceramic applications, 100 % pure natural Kolinsky sable.
Wysokiej jakości pędzle sobolowe ze 100% naturalnego włosia do nakładania ceramiki.

each / sztuka

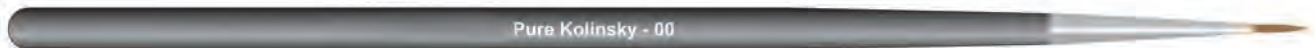

Pure Kolinsky - 00





Lathe brushes

For pre-polishing of prosthetic plastic, metal alloys, and crown and bridge work with polishing paste

max. 2'800 rpm

each / sztuka



Ø 40 x 80 mm

Ø 40 x 80 mm

Materials	Grey/White horse hair	White goat hair
Materiały	Grey/White horse hair	White goat hair
Stiffness	Medium soft	Extra soft
Code / Kod	P122	P150

each / sztuka



Ø 40 x 80 mm

Ø 30 x 63 mm

Materials	Pure black bristles	Pure black bristles
Materiały	Pure black bristles	Pure black bristles
Stiffness	Extra stiff	Extra stiff
Code / Kod	P008	P022

Scotchbrite wheels

Szczotka z włókniny polerskiej

max. 10'000 rpm

Mounted, each / Montowane, sztuka

each / sztuka



Code / Kod	ST-W/BC25HP	ST-W/SBM25HP	ST-W/SBF25HP
Grade	Coarse	Medium	Fine
Ø mm	25,0	25,0	25,0

Diamond discs for metals / Tarcze diamentowe (separatory) do cięcia metali

For cutting precious alloys, chromium cobalt, stainless steel, aluminum and other non-precious alloys.

Przeznaczone również do cięcia stopów szlachetnych, chromu, kobaltu, stali nierdzewnej, aluminium i innych stopów nieszlachetnych.

max. 15'000 rpm

Two sided diamond grit, superflexible
Dwustronny nasyp diamentowy, bardzo elastyczne



Mounted HP
Montowane na
prostownicę



	L mm	0,15	0,15	0,10	0,12	0,15
	Ø mm	13,0	19,0	22,0	22,0	22,0
Mounted, each / Montowane, sztuka	Code / Kod	DD001HP	DD002HP	DD003HP	DD004HP	DD005HP



Mounted HP
Montowane na
prostownicę

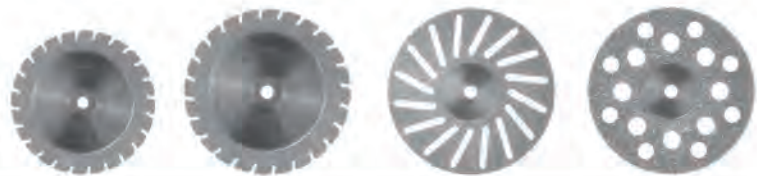

	L mm	0,15	0,15	0,15	0,15
	Ø mm	19,0	22,0	22,0	22,0
Mounted, each / Montowane, sztuka	Code / Kod	DD006HP	DD007HP	DD008HP	DD009HP

ZIRCOLINE

Diamond discs rigid / Tarcze diamentowe (separatory) sztywne

Specialy developed for separating of zirconia prosthesis and other ceramics. Super high quality and cutting efficiency that does not leave any marks or black spots on the ceramic work piece.

Przeznaczone do separacji i szlifowania porcelany oraz cyrkonu. Długa trwałość i najwyższa wydajność cięcia. Nie pozostawiają żadnych śladów ani czarnych plam na pracach ceramicznych.

max. 15'000 rpm



Mounted HP
Montowane na
prostownicę



	L mm	0,16	0,22
	Ø mm	19,0	19,0
Mounted, each / Montowane, sztuka	Code / Kod	D915CF	D915C

Polishers latex free / Gumki do polerowania bez lateksu

max. 15'000 rpm

Super silicone polishers / Super silikonowe gumki do polerowania

A three-step polishing system for acrylics, quicker and finer result, produce less dust.
Trzystopniowy system do polerowania akrylu, zapewniający szybszy i skuteczniejszy efekt, niska emisja pyłów.

each / sztuka



Code / Kod	S161	S162	S163	S172	S173	S031	S032	S033
L mm	20,0	24,0	18,0	24,0	18,0	16,0	24,0	18,0
Ø mm	10,0	10,0	15,0	10,0	15,0	5,5	10,0	15,0

Step 1 - Removing and shaping
Stopień 1 - Kształtowanie

Step 2 - Smoothing
Stopień 2 - Wygladzanie

Step 3 - High shine polishing
Stopień 3 - Polerowanie na wysoki połysk

Standard silicone polishers / Standardowe silikonowe gumki do polerowania

max. 15'000 rpm

A three-step polishing system for prosthetic and orthodontic acrylics. Available in three grits.
Trzystopniowy system do polerowania akryli protetycznych i ortodontycznych. Dostępne z 3 rodzajami nasypu: drobno, średnio i gruboziarnistym.

each / sztuka



Code / Kod	S012	S013	S022	S023	S024	S031	S032	S033
L mm	20,0	24,0	20,0	24,0	18,0	16,0	24,0	18,0
Ø mm	10,0	10,0	10,0	10,0	15,0	5,5	10,0	15,0

Step 1 - Removing and shaping
Stopień 1 - Kształtowanie

Step 2 - Smoothing
Stopień 2 - Wygladzanie

Step 3 - High shine polishing
Stopień 3 - Polerowanie na wysoki połysk

Eco-System

A three-step polishing system for prosthetic and orthodontic acrylics. Available in three grits.
Trzystopniowy system do polerowania akryli protetycznych i ortodontycznych. Dostępne z 3 rodzajami nasypu: drobno, średnio i gruboziarnistym.

Mandrels HP / Mandryle na prostnice

each / sztuka



Code / Kod	S015	S025	S035
L mm	24,0	24,0	24,0
Ø mm	10,0	10,0	10,0

Code / Kod	CTP031	CTP035	DB.9999.00	DB.9999.01
Fig	301HP	310HP	303HP	304HP



Polishers latex free / Gumki do polerowania bez lateksu

Universal silicone polishers / Uniwersalne silikonowe gumki do polerowania

A single step polishing system for ceramics, precious metal alloys, veneer acrylics and dentine.
Jednostopniowy system do polerowania ceramiki, stopów metali szlachetnych, licówek akrylowych i zębiny.

max. 20'000 rpm

each / sztuka

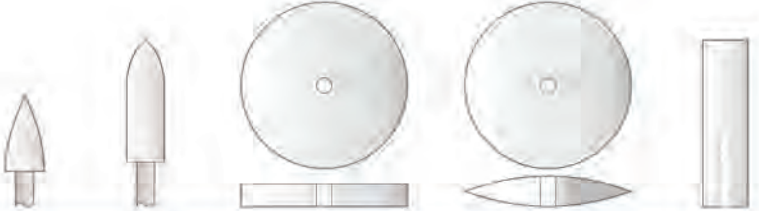

Code / Kod	S001	S002	S003	S004	S006
L mm	10,0	16,0	3,0	4,0	20,0
Ø mm	4,5	5,0	22,0	22,0	7,0

Synthetic rubber polishers / Syntetyczne gumki do polerowania

A two-step polishing system for precious and semi precious alloys.
Dwustopniowy system do polerowania stopów metali szlachetnych i półszlachetnych.

max. 20'000 rpm

each / sztuka

Step 1
Pre-polishing

Stopień 1
Polerowanie wstępne



Code / Kod	S042	S043	S044	S047	S046	S045
L mm	16,0	3,0	4,0	24,5	20,0	20,0
Ø mm	5,0	22,0	22,0	3,0	2,0	7,0

each / sztuka

Step 2
Highgloss polishing

Stopień 2
Polerowanie na wysoki połysk

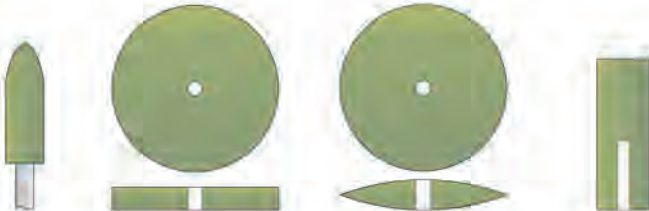

Code / Kod	S052	S053	S054	S055
L mm	16,0	3,0	4,0	20,0
Ø mm	5,0	22,0	22,0	7,0



Polishers latex free / Gumki do polerowania bez lateksu

Synthetic rubber polishers, A two-step polishing system for metal alloys and chrome cobalt.
Syntetyczne gumki do polerowania. Dwustopniowy system do polerowania stopów metali, chromu, kobaltu.

max. 20'000 rpm

Step 1
Pre-polishing

Stopień 1
Polerowanie wstępne

each / sztuka

Code / Kod	S091	S092	S093	S094	S095	S096
L mm	16,0	3,0	4,0	24,5	20,0	20,0
Ø mm	5,0	22,0	22,0	3,0	2,0	7,0

Step 2
Polishing

Stopień 2
Polerowanie pośrednie

each / sztuka

Code / Kod	S101	S102	S103	S104	S105	S106
L mm	16,0	3,0	4,0	24,5	20,0	20,0
Ø mm	5,0	22,0	22,0	3,0	2,0	7,0

MAXCUT
Diamond cutting discs / Tarcze ściernie diamentowe

For cutting all kind of alloys, separating composites and also ceramics.
Przeznaczone do cięcia wszystkich rodzajów stopów, separacji kompozytu i ceramiki.

max. 25'000 rpm



Code / Kod	D940	D941
Ø mm	Ø 20 mm	Ø 20 mm
	each / sztuka	each / sztuka

MAXCUT Cutting discs / Tarcze ściernie (ściernice)

Glass fibre reinforced ultra-thin grinding wheels for cutting precious and non-precious metals.
Mounted on low-powered motors.

Wzmocnione siatką z włókna szklanego ultra-cienkie ściernice do cięcia metali szlachetnych i nieszlachetnych.
Montowane na mikrosilnik.

max. 20'000 rpm



Code / Kod	D942	D943	D944
Ø mm	Ø 26 mm	Ø 40 mm	Ø 40 mm
	each / sztuka	each / sztuka	each / sztuka

Grinding caps and holders / Gumki do szlifowania i uchwyty

For working on denture acrylics, tray material, plaster and all soft reline materials.
Przeznaczone do akrylu, materiału na łyżki indywidualne, gipsu i mas silikonowych.

max. 15'000 rpm



SKWR/5	SKWR/7	SKWR/10	SKWR/13	SKWR/15
7,0	9,0	12,0	15,0	18,0
11,2	12,5	14,8	18,9	26,0



Diamond burs / Wiertła diamentowe

801

	007	008	010	012	014	016	018	021	023	025	035
● 801EF FG 314.001.504				012	014	016	018				
● 801F FG 314.001.514	007	008	010	012	014	016	018	021	023	025	035
● 801 FG 314.001.524	007	008	010	012	014	016	018	021	023	025	035
● 801G FG 314.001.534			010	012	014	016	018	021	023	025	
● 801SG FG 314.001.544				012	014	016	018	021	023	025	

802

L mm	3.5	3.5	3.5
● 801 FG 314.001.524	014	016	018
● 801G FG 314.001.534	014	016	018
● 801SG FG 314.001.544	014	016	018

388

L mm	8.0	8.0	8.0	8.0
● 388 FG 314.388.524	010	012	014	016
● 388G FG 314.388.534	010	012	014	016
● 388SG FG 314.388.544	010	012	014	016

802L

L mm	10.0	10.0	10.0	10.0
● 802L FG 314.494.524	012	014	016	018
● 802LG FG 314.494.534	010	012	014	016
● 802LSG FG 314.494.544	010	012	014	016

805

L mm	1.0	1.0	1.5	1.5	2.3	2.3
● 805F FG 314.012.514	010	012	014	016		
● 805 FG 314.012.524	010	012	014	016	018	021
● 805G FG 314.012.534			014	016	018	
● 805SG FG 314.012.544			014	016	018	021

806

L mm	3.0	3.0
● 806F FG 314.019.514	012	
● 806 FG 314.019.524	012	014
● 806G FG 314.019.534	012	014
● 806SG FG 314.019.544	014	

870

L mm	1.5	1.9
● 870 FG 314.032.524	014	018
● 870G FG 314.032.534	014	018
● 870SG FG 314.032.544	014	018

899

L mm	6.5
● 899 FG 314.033.524	021
● 899G FG 314.033.534	021

838L

L mm	6.0	6.0	6.0
● 838EFL FG 314.140.504	010	012	014
● 838FL FG 314.140.514	010	012	014
● 838L FG 314.140.524	010	012	014
● 838GL FG 314.140.534	010	012	014
● 838SGL FG 314.140.544	010	012	014

835

L mm	3.0	3.0	3.5	3.5	3.5	3.5
● 835F FG 314.108.504			012	014	016	
● 835 FG 314.108.514	006	008	010	012	014	
● 835G FG 314.108.524	006	008	010	012	014	016
● 835G FG 314.108.534	006	008	010	012	014	016
● 835SG FG 314.108.544			010	012	014	016

835L

L mm	4.0	4.0	4.0	4.0	4.0	4.0
● 835LF FG 314.108.514	010	012	014	016	018	
● 835L FG 314.108.524	008	010	012	014	016	018
● 835LG FG 314.108.534	008	010	012	014	016	018
● 835LSG FG 314.108.544	010	012	014	016	018	

811

L mm	4.0
● 811F FG 314.038.514	033
● 811 FG 314.038.524	033
● 811G FG 314.038.534	033
● 811SG FG 314.038.544	033

837

L mm	6.0	6.0	6.0	6.0
● 837F FG 314.110.504	010	012	014	
● 837 FG 314.110.514	010	012	014	016
● 837G FG 314.110.524	010	012	014	016
● 837G FG 314.110.534	010	012	014	016
● 837SG FG 314.110.544	012	014	016	

837L

L mm	8.0	8.0	8.0	8.0
● 837LF FG 314.111.504	010	012	014	
● 837L FG 314.111.514	010	012	014	016
● 837LG FG 314.111.524	010	012	014	016
● 837LG FG 314.111.534	010	012	014	016
● 837LSG FG 314.111.544	012	014	016	

885

L mm	8.0	8.0	8.0	8.0
● 885F FG 314.130.504	010	012	014	
● 885 FG 314.130.514	010	012	014	016
● 885G FG 314.130.524	010	012	014	016
● 885G FG 314.130.534	010	012	014	016
● 885SG FG 314.130.544	012	014	016	



Diamond burs / Wiertła diamentowe

Each / Sztuka

838L

L mm	6.0	6.0	6.0
------	-----	-----	-----

838EFL FG	314.140.504	010	012	014
838FL FG	314.140.514	010	012	014
838L FG	314.140.524	010	012	014
838GL FG	314.140.534	010	012	014
838SGL FG	314.140.544	010	012	014

881

L mm	8.0	8.0	8.0	8.0
------	-----	-----	-----	-----

881EF FG	314.141.504				
881F FG	314.141.514	010	012	014	016
881 FG	314.141.524	010	012	014	016
881G FG	314.141.534	010	012	014	016
881SGFG	314.141.544		012	014	016

882

L mm	10.0	10.0	10.0
------	------	------	------

882EF FG	314.142.504			
882F FG	314.142.514	012	014	016
882 FG	314.142.524	012	014	016
882G FG	314.142.534	012	014	016
882SGFG	314.142.544	012	014	016

837KR

L mm	8.0	8.0	8.0
------	-----	-----	-----

837KREF FG	314.158.504		014	
837KRF FG	314.158.514	012	014	016
837KR FG	314.158.524	012	014	016
837KRG FG	314.158.534	012	014	016
837KRSG FG	314.158.544	012	014	016

898

L mm	6.0	6.0	6.0	6.0
------	-----	-----	-----	-----

898EF FG	314.164.504	010	012	014	016
898F FG	314.164.514	010	012	014	016
898 FG	314.164.524	010	012	014	016
898G FG	314.164.534		012	014	016
898SGFG	314.164.544			014	016

858

L mm	8.0	8.0	8.0	8.0
------	-----	-----	-----	-----

858EF FG	314.165.504	010	012	014	016
858F FG	314.165.514	010	012	014	016
858 FG	314.165.524	010	012	014	016
858G FG	314.165.534	010	012	014	016
858SGFG	314.165.544			014	016

859L

L mm	11.5	11.5	11.5	11.5	11.5
------	------	------	------	------	------

859LEF FG	314.167.504	010	012	014	016	018
859LF FG	314.167.514	010	012	014	016	018
859L FG	314.167.524	010	012	014	016	018
859LG FG	314.167.534	010	012	014	016	018
859LSG FG	314.167.544			014	016	018

845

L mm	3.0	3.0	3.0	4.0	4.0	4.0	4.0
------	-----	-----	-----	-----	-----	-----	-----

845EF FG	314.168.504						
845F FG	314.168.514						
845 FG	314.168.524	007	008	009	010	012	014
845G FG	314.168.534					012	014
845SG FG	314.168.544						014

867

L mm	6.0	6.0
------	-----	-----

867EF FG	314.288.504		
867F FG	314.288.514	010	012
867 FG	314.288.524	010	012
867G FG	314.288.534	010	012
867SG FG	314.288.544	010	012

846

L mm	6.0	6.0	6.0	6.0
------	-----	-----	-----	-----

846EF FG	314.171.504			
846F FG	314.171.514	012	014	016
846 FG	314.171.524	012	014	016
846G FG	314.171.534	012	014	016
846SGFG	314.171.544		014	016

847

L mm	8.0	8.0	8.0	8.0	8.0
------	-----	-----	-----	-----	-----

847EF FG	314.172.504				
847F FG	314.172.514	012	014	016	018
847 FG	314.172.524	012	014	016	018
847G FG	314.172.534	012	014	016	018
847SG FG	314.172.544	012	014	016	018

848

L mm	10.0	10.0	10.0	10.0	10.0	10.0
------	------	------	------	------	------	------

848EF FG	314.173.504	012	014	016	018
848F FG	314.173.514	012	014	016	018
848 FG	314.173.524	012	014	016	018
848G FG	314.173.534	012	014	016	018
848SG FG	314.173.544	012	014	016	018

849

L mm	6.0	6.0	6.0	6.0	6.0	6.0
------	-----	-----	-----	-----	-----	-----

849EF FG	314.197.504	010	012	014	016	018	023	025
849F FG	314.197.514	010	012	014	016	018	023	025
849 FG	314.197.524	010	012	014	016	018	023	025
849G FG	314.197.534	010	012	014	016	018	023	025
849SG FG	314.197.544				012	014	016	018

848L

L mm	11.5	11.5	11.5	11.5	11.5
------	------	------	------	------	------

848LEF FG	314.174.504	014	016	018
848LF FG	314.174.514	014	016	018
848L FG	314.174.524	014	016	018
848LG FG	314.174.534	014	016	018
848LSG FG	314.174.544	014	016	018



Diamond burs / Wiertła diamentowe

Each / Szuka



863L

L mm	11.5	11.5	11.5	
863LEF FG	314.251.504	014	016	018
863LF FG	314.251.514	014	016	018
863L FG	314.251.524	014	016	018
863LG FG	314.251.534	014	016	018
863LSG FG	314.251.544	014	016	018



850

L mm	8.0	8.0	8.0	8.0	8.0	8.0	8.0		
850EF FG	314.198.504	010	012	014	016	018	021	023	025
850F FG	314.198.514	010	012	014	016	018	021	023	025
850 FG	314.198.524	010	012	014	016	018	021	023	025
850G FG	314.198.534	010	012	014	016	018	021	023	025
850SG FG	314.198.544	010	012	014	016	018	021	023	025



852

L mm	10.0	10.0	10.0	10.0	10.0	
852EF FG	314.199.504	010	012	014	016	018
852F FG	314.199.514	010	012	014	016	018
852 FG	314.199.524	010	012	014	016	018
852G FG	314.199.534	010	012	014	016	018
852SG FG	314.199.544	010	012	014	016	018



807

L mm	3.5	3.5	4.0	4.0	
807F FG	314.225.514	012	014	016	018
807 FG	314.225.524	012	014	016	018
807G FG	314.225.534	012	014	016	018
807SG FG	314.225.544	014	016	018	



808R

L mm	5.0	5.0	5.0	5.0	
808RF FG	314.238.514	010	012	014	016
808R FG	314.238.524	010	012	014	016
808RG FG	314.238.534	014	016		

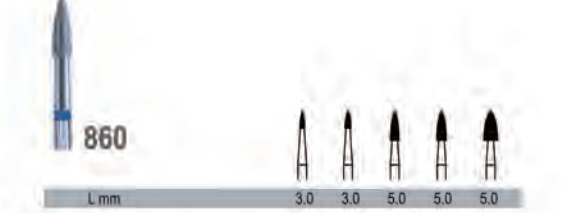

860

L mm	3.0	3.0	5.0	5.0	5.0	
860EF FG	314.243.504	010	012	018	023	025
860F FG	314.243.514	010	012	018	023	025
860 FG	314.243.524	010	012	018	023	025
860G FG	314.243.534	010	012	018	023	025
860SG FG	314.243.544	012	018	023	025	



862

L mm	8.0	8.0	8.0	8.0	
862EF FG	314.249.504	010	012	014	016
862F FG	314.249.514	010	012	014	016
862 FG	314.249.524	010	012	014	016
862G FG	314.249.534	012	014	016	
862SG FG	314.249.544	012	014	016	



863

L mm	10.0	10.0	10.0	10.0	
863EF FG	314.250.504	012	014	016	018
863F FG	314.250.514	012	014	016	018
863 FG	314.250.524	012	014	016	018
863G FG	314.250.534	012	014	016	018
863SG FG	314.250.544	012	014	016	018



831

L mm	4.0	4.0	4.0	4.0	5.0	
831EF FG	314.254.504	014	016	018	021	023
831F FG	314.254.514	014	016	018	021	023
831 FG	314.254.524	014	016	018	021	023
831G FG	314.254.534	014	016	018	021	023
831SG FG	314.254.544	014	016	018	021	023

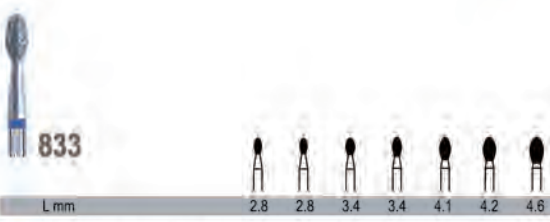

833

L mm	2.8	2.8	3.4	3.4	4.1	4.2	4.6	
833EF FG	314.277.504	012	014	016	018	021	023	025
833F FG	314.277.514	012	014	016	018	021	023	025
833 FG	314.277.524	012	014	016	018	021	023	025
833G FG	314.277.534	012	014	016	018	021	023	025
833SG FG	314.277.544	012	014	016	018	021	023	025

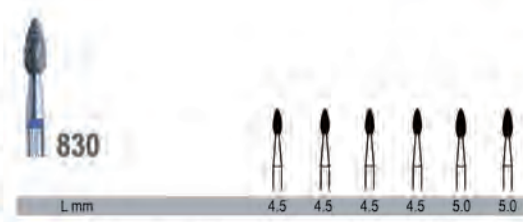

830

L mm	4.5	4.5	4.5	4.5	5.0	5.0	
830EF FG	314.257.504	012	014	016	018	021	023
830F FG	314.257.514	012	014	016	018	021	023
830 FG	314.257.524	012	014	016	018	021	023
830G FG	314.257.534	012	014	016	018	021	023
830SG FG	314.257.544	012	014	016	018	021	023

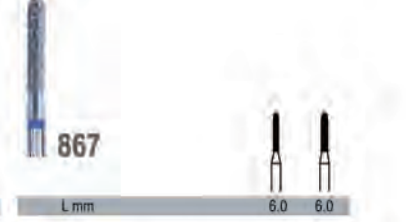

867

L mm	6.0	6.0	
867F FG	314.288.514	010	012
867 FG	314.288.524	010	012
867G FG	314.288.534	010	012
867SG FG	314.288.544	010	012

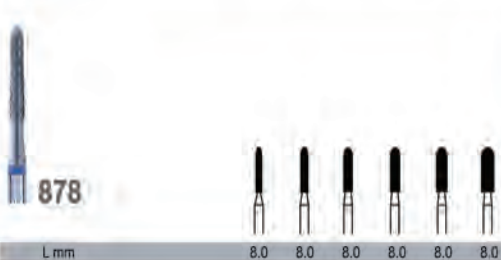

878

L mm	8.0	8.0	8.0	8.0	8.0	8.0	
878F FG	314.298.514	012	014	016	018	021	
878 FG	314.298.524	012	014	016	018	021	023
878G FG	314.298.534	012	014	016	018	021	023
878SG FG	314.298.544	012	014	016	018	021	023

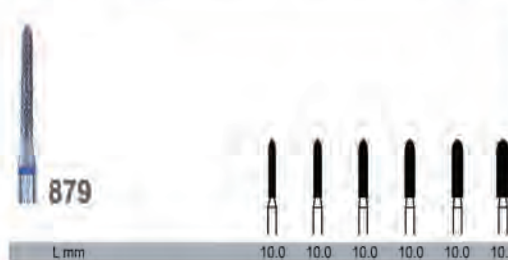

879

L mm	10.0	10.0	10.0	10.0	10.0	10.0	
879F FG	314.299.514	012	014	016	018		
879 FG	314.299.524	012	014	016	018	021	023
879G FG	314.299.534	012	014	016	018	021	023
879SG FG	314.299.544	012	014	016	018	021	

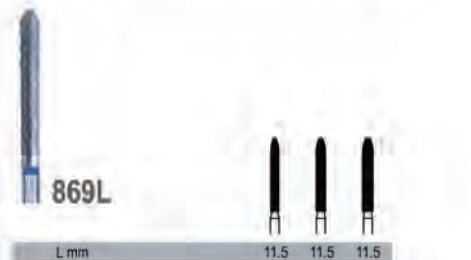

869L

L mm	11.5	11.5	11.5	
869LF FG	314.291.514	012	014	016
869L FG	314.291.524	012	014	016
869LG FG	314.291.534	012	014	016



Diamond burs / Wiertła diamentowe

869

L mm	10.0	10.0	10.0	10.0	
869EF FG	314.290.504	010	012	014	016
869F FG	314.290.514	010	012	014	016
869 FG	314.290.524	010	012	014	016
869G FG	314.290.534		012	014	016
869SG FG	314.290.544			014	016

893

L mm	5.8	5.8	
893F FG	314.507.514	018	023
893 FG	314.507.524	018	023
893G FG	314.507.534	018	023
893SG FG	314.507.544	018	023

508

L mm	8.0	8.0	
508F FG	314.508.514	018	021
508 FG	314.508.524	018	021
508G FG	314.508.534	018	021
508SG FG	314.508.544	018	021

Each / Sztuka

Carbide burs / Wiertła z węgla spiekane

CB1

Size / Rozmiar Ø 1/10 mm	005	006	008	010	012	014	016	018	021	023	
CB1 RA	500.204.001.001			010	012	014	016	018	021	023	
CB1 RAL	500.205.001.001	005	006	008	010	012	014	016	018	021	023
CB1 FG	500.314.001.001		006		010	012	014	016	018	021	023
CB1 FG XL	500.316.001.001		006		010	012	014	016	018	021	023

CB1S

Size / Rozmiar Ø 1/10 mm	005	006	007	008	010	012	014	016	018	021	023	025	027	029	
CB1S RA	500.204.001.003	005	006	007	008	010	012	014	016	018	021	023	025	027	029
CB1S RAL	500.205.001.003	005	006	007	008	010	012	014	016	018	021	023	025	027	029
CB1S FG	500.314.001.003	005	006	007	008	010	012	014	016	018	021	023	025	027	029
CB1S FG XL	500.316.001.003	005	006	007	008	010	012	014	016	018	021	023	025	027	029

CB1SX

Size / Rozmiar Ø 1/10 mm	010	012	014	016	018	021	023	025	027	029	
CB1SX RA	500.204.001.002	010	012	014	016	018	021	023	025	027	029

CB1SNX

Size / Rozmiar Ø 1/10 mm	010	012	014	016	018	021	023	
CB1SNX RA	500.204.697.002	010	012	014	016	018	021	023
CB1SNX RAL	500.205.697.002	010	012	014	016	018	021	023

CB1SN

Size / Rozmiar Ø 1/10 mm	010	012	014	016	018	021	023	
CB1SN RA	500.204.697.003	010	012	014	016	018	021	023
CB1SN RAL	500.205.697.003	010	012	014	016	018	021	023

Each / Sztuka



Carbide burs / Wiertła z węgla spiekanego

Each / Sztuka

CB2

Size / Rozmiar \varnothing 1/10 mm		008	010	012	014	016	018
CB2 RA	500.204.010.006						
	OAL 22 mm						
CB2 FG	500.314.010.006						
	OAL 19 mm						

CB7

Size / Rozmiar \varnothing 1/10 mm		006	008	010	012
CB7 FG	500.314.237.001				
	OAL 19 mm				

CB23

Size / Rozmiar \varnothing 1/10 mm		008	009	010	012
CB23 FG	500.314.168.006				
	OAL 19 mm				
CB23 FG XL	500.316.168.006				012
	OAL 25 mm				

CB21

Size / Rozmiar \varnothing 1/10 mm		008	010	012	014
CB21 FG	500.314.107.006				
	OAL 19 mm				
CB21 FG XL	500.316.107.006				
	OAL 25 mm				
CB21 RA	500.204.107.006			010	012
	OAL 22 mm				

CB31

Size / Rozmiar \varnothing 1/10 mm		008	009	010	012	014
CB31 FG	500.314.107.007					
	OAL 19 mm					
CB31 FG XL	500.316.107.007				010	012
	OAL 25 mm					
CB31 RA	500.204.107.007				010	012
	OAL 22 mm					

CB21R

Size / Rozmiar \varnothing 1/10 mm		008	010	012
CB21R FG	500.314.137.006			
	OAL 19 mm			

CB31R

Size / Rozmiar \varnothing 1/10 mm		010	012
CB31R FG	500.314.137.007		
	OAL 19 mm		
CB31R FG XL	500.316.137.007		
	OAL 25 mm		

CB23R

Size / Rozmiar \varnothing 1/10 mm		012	016
CB23R FG	500.314.194.006		
	OAL 19 mm		
CB23R RA	500.204.194.006		
	OAL 22 mm		

CB33

Size / Rozmiar \varnothing 1/10 mm		010	012	016	021
CB33 FG	500.314.168.007				
	OAL 19 mm				



Crown cutters / Wiertła do Cięcia Koron

Each / Szuka



CB5CK

Size / Rozmiar \varnothing 1/10 mm	OAL 19 mm	012	014
CB5CK FG 500.314.194.019		012	014
	OAL 25 mm		
CB5CK FG XL 500.316.194.019		012	014



CB4MCL

Size / Rozmiar \varnothing 1/10 mm	OAL 19 mm	012	014
CB4MCL FG 500.314.139.019		012	014



CB5MCL

Size / Rozmiar \varnothing 1/10 mm	OAL 19 mm	012	014
CB5MCL FG 500.314.140.019		012	014



CB6MCL

Size / Rozmiar \varnothing 1/10 mm	OAL 19 mm	012	014
CB6MCL FG 500.314.141.019		012	014



CB35C

Size / Rozmiar \varnothing 1/10 mm	OAL 19 mm	012
CB35C FG 500.314.138.008		012
	OAL 25 mm	
CB35C FG XL 500.316.138.008		012



CB37

Size / Rozmiar \varnothing 1/10 mm	OAL 19 mm	012
CB37 FG 500.314.139.008		012

Finishing burs / Finiry

Each / Szuka



CF41

Size / Rozmiar \varnothing 1/10 mm	OAL 19 mm	014	018	023
CF41 FG 500.314.001.071		014	018	023



CF46

Size / Rozmiar \varnothing 1/10 mm	OAL 19 mm	014
CF46 FG 500.314.254.072		014



CF135

Size / Rozmiar \varnothing 1/10 mm	OAL 19 mm	014
CF135FG 500.314.166.071		014



CF379

Size / Rozmiar \varnothing 1/10 mm	OAL 19 mm	014	018	023
CF379 FG 500.314.277.072		014	018	023



Surgical burs / Wiertła chirurgiczne



CB141

Size / Rozmiar Ø 1/10 mm		010	012	014	016	018	023	027	031	035	040	
	OAL 44.5 mm											
CB141 HP	500 104 001 291											
	OAL 26 mm											
CB141 RAL	500 205 001 291	010	012	014	016	018	023					
	OAL 34 mm											
CB141 RAXL	500 206 001 291	010	012	014	016	018	023					



CB151

Size / Rozmiar Ø 1/10 mm		016
L mm		10,7
	OAL 23 mm	
CB151 FGL	500 315 199 295	016
	OAL 28 mm	
CB151 FGXL	500 316 199 295	016



CB141A

Size / Rozmiar Ø 1/10 mm		010	012	014	016	018	023	027	031	035	040	
	OAL 44.5 mm											
CB141A HP	500 104 001 298											
	OAL 26 mm											
CB141A RAL	500 205 001 298	010	012	014	016	018	023					
	OAL 34 mm											
CB141A RAXL	500 206 001 298	010	012	014	016	018	023					



CB152

Size / Rozmiar Ø 1/10 mm		014	016
L mm		9,0	9,0
	OAL 23 mm		
CB152 FGL	500 315 210 295	014	016
	OAL 28 mm		
CB152 FGXL	500 316 210 295	014	016



CB161

Size / Rozmiar Ø 1/10 mm		016
L mm		9,0
	OAL 44.5 mm	
CB161 HP	500 104 408 295	016
	OAL 29 mm	
CB161 RAL	500 205 408 295	016
	OAL 28 mm	
CB161 RAXL	500 316 408 295	016



CB162

Size / Rozmiar Ø 1/10 mm		016
L mm		9,0
	OAL 44.5 mm	
CB162 HP	500 104 408 297	016
	OAL 29 mm	
CB162 RAL	500 205 408 297	016
	OAL 28 mm	
CB162 RAXL	500 316 408 297	016



CB162A

Size / Rozmiar Ø 1/10 mm		016
L mm		9,0
	OAL 44.5 mm	
CB162A HP	500 104 408 298	016
	OAL 29 mm	
CB162A RAL	500 205 408 298	016
	OAL 28 mm	
CB162A RAXL	500 316 408 298	016



CB164

Size / Rozmiar Ø 1/10 mm		010
L mm		6,0
	OAL 44.5 mm	
CB164 HP	500 104 407 297	010
	OAL 29 mm	
CB164 RAL	500 205 407 297	010



CB165

Size / Rozmiar Ø 1/10 mm		023
L mm		7,0
	OAL 44.5 mm	
CB165 HP	500 104 408 297	023
	OAL 29 mm	
CB165 RAL	500 205 408 297	023



CB166

Size / Rozmiar Ø 1/10 mm		021
L mm		10,0
	OAL 44.5 mm	
CB166 HP	500 104 409 297	021
	OAL 29 mm	
CB166 RAL	500 205 409 297	021



CB167

Size / Rozmiar Ø 1/10 mm		023
L mm		10,0
	OAL 44.5 mm	
CB167 HP	500 104 410 297	023
	OAL 29 mm	
CB167 RAL	500 205 410 297	023



Tungsten Carbide Burs

- Made of high quality Tungsten Carbide
- Precision toothing, superior cutting and durable
- Perfectly concentric
- Available in x-fine, fine, medium, coarse and x-coarse grits
- Color coded according to grit type
- Standard ISO patterns

Frezy protetyczne z węgla spiekanego

Wykonane z wysokiej jakości węgla spiekanego
Charakteryzują się dużą wytrzymałością, precyzyjnie obrabiają materiał
Koncentryczne
Dostępne ostrza z nacięciami: bardzo drobnymi, drobnymi, standardowymi, grubymi i bardzo grubymi
Oznaczone kolorem zgodnie z rodzajem ostrza
Modele zgodne ze standardami ISO

Cross Cut Fine (ISO-No. 140)

Frezy z drobnymi krzyżowymi nacięciami

For delicate and difficult trimming of hard alloys, acrylics and ceramics
Do obróbki akrylu, ceramiki oraz metalu



Shank	ISO No.	DB.9257.233	DB.9237.233	DB.9225.233	DB.9141.233	DB.9289.233	DB.9198.233	DB.9187.233	DB.9292.233	DB.9113.603
HP	500 104...	... 257..140	... 237..140	... 225..140	... 141..140	... 289..140	... 198..140	... 187..140	... 292..140	... 113..140
	Ø mm	2,3	2,3	2,3	2,3	2,3	2,3	2,3	2,3	6,0
	L1 mm	5,5	5,5	5,5	8,0	8,0	8,0	15,0	14,0	12,5
	L2 mm	45,0	45,0	45,0	45,0	45,0	45,0	45,0	45,0	52,0



Shank	ISO No.	DB.9145.233	DB.9123.233	DB.9200.403	DB.9201.503	DB.9200.603	DB.9237.603	DB.9275.603	DB.9144.603
HP	500 104...	... 145..140	... 123..140	... 194..140	... 201..140	... 200..140	... 237..140	... 275..140	... 144..140
	Ø mm	2,3	2,3	4,0	5,0	6,0	6,0	6,0	6,0
	L1 mm	14,0	14,0	13,5	13,5	13,5	13,0	14,0	13,0
	L2 mm	45,0	45,0	52,0	52,0	52,0	52,0	52,0	52,0



Cross Cut X-Fine (ISO-No. 110)

Frezy z bardzo drobnymi krzyżowymi nacięciami

For fine, precise trimming of ceramics, precious metals and all non-precious alloys
Do obróbki ceramiki, metali szlachetnych oraz tworzyw sztucznych



Shank	ISO No.	DB.9237.232	DB.9199.232	DB.9292.232	DB.9145.232	DB.9200.402
HP	500 104...	... 237..110	... 199..110	... 292..110	... 145 110	... 200..110
	Ø mm	2,3	2,3	2,3	2,3	4,0
	L1 mm	5,5	11,5	14,0	14,0	13,5
	L2 mm	45,0	45,0	45,0	45,0	52,0

Cross Cut Standard (ISO-No.190)

Frezy niebieskie ze standardowymi krzyżowymi nacięciami

For trimming large surfaces of acrylics, tray materials and plaster
Do obróbki stopów, metali, akrylu oraz gipsu



Shank	ISO No.	DB.9142.234	DB.9185.234	DB.9187.454	DB.9199.234	DB.9200.604	DB.9250.234	DB.9275.604
HP	500 104...	... 142..190	... 185..190	... 187..190	... 199..190	... 200..190	... 250..190	... 275..190
	Ø mm	2,3	2,3	4,5	2,3	6,0	2,3	6,0
	L1 mm	2,3	2,3	11,5	11,0	13,5	9,5	14,0
	L2 mm	45,0	45,0	48,0	45,0	52,0	45,0	52,0

Cross Cut Coarse (ISO-No. 220)

Frezy zielone z grubymi krzyżowymi nacięciami

For trimming large surfaces of acrylics, tray materials and plaster / Do obróbki akrylu oraz gipsu



Shank	ISO No.	DB.9001.235	DB.9001.405	DB.9199.235	DB.9187.235	DB.9292.235	DB.9145.235	DB.9122.235
HP	500 104...	... 001 220	... 001 220	... 199..220	... 187..220	... 292..220	... 145 220	... 122 220
	Ø mm	2,3	4,5	2,3	2,3	2,3	2,3	2,3
	L1 mm	2,3	3,4	11,0	15,5	2,3	14,0	14,0
	L2 mm	45,0	45,0	45,0	45,0	45,0	45,0	45,0



Cross Cut Coarse (ISO-No. 220)

Frezy zielone z grubymi krzyżowymi nacięciami

For trimming large surfaces of acrylics, tray materials and plaster / Do obróbki akrylu oraz gipsu



Shank	ISO No.	DB.9200.405	DB.9201.505	DB.9201.605	DB.9200.605	DB.9237.605	DB.9277.605	DB.9275.605	DB.9144.605	DB.9113.605
HP	500 104...	... 200..220	... 201..220	... 201..220	... 200..220	... 237..220	... 277..220	... 275..220	... 144..220	... 113..220
	Ø mm	4,0	5,0	6,0	6,0	6,0	6,0	6,0	6,0	6,0
	L1 mm	13,5	13,5	13,5	13,0	13,0	14,0	13,5	13,5	13,2
	L2 mm	52,0	52,0	52,0	52,0	52,0	52,0	52,0	52,0	51,0

Cross Cut X-Coarse (ISO-No. 223)

Frezy z bardzo grubymi krzyżowymi nacięciami

The optimum for plaster – also wet plaster / Do obróbki gipsu również na mokro



Shank	ISO No.	DB.9200.408	DB.9201.608	DB.9275.608	DB.9144.608
HP	500 104...	... 200..223	... 201..223	... 275..223	... 144..223
	Ø mm	4,0	6,0	6,0	6,0
	L1 mm	13,5	13,5	13,5	13,5
	L2 mm	52,0	52,0	52,0	50,0



Aluminum burs stands
Podstawki do wiertel aluminiowe

Aluminum burs stands
Podstawki do wiertel aluminiowe

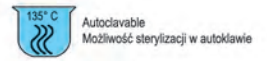

DZ.062.010
FG
60x40 mm
for 24 burs / na 24 sztuki



DZ.062.030
FG & CA / RA
60x40 mm
for 24 burs / na 24 sztuki



DZ.062.020
CA / RA
60x40 mm
for 24 burs / na 24 sztuki



DZ.063.010
FG
60x50 mm
for 36 burs / na 36 sztuk



DZ.063.030
FG & CA / RA
60x50 mm
for 36 burs / na 36 sztuk



DZ.063.020
CA / RA
60x50 mm
for 36 burs / na 36 sztuk

Plastic covers only
Przykrywki plastikowe na podstawki do wiertel



Non-autoclavable
Nie można sterylizować
w autoklawie

60x40x30 mm

DZ.062.000



Non-autoclavable
Nie można sterylizować
w autoklawie

60x50x30 mm

DZ.063.000

Burs disinfecting box stainless steel
Pojemnik do dezynfekcji wiertel ze stali nierdzewnej

Burs disinfecting box plastic
Pojemnik do dezynfekcji wiertel plastikowy



DZ.051.010
Ø 76 mm x H 35 mm



DZ.050.010
Ø 85 mm x H 70 mm



Acrylic grinding box



DL.1418.00

- Ideal for grinding and sand blasting
- Retains flying debris
- Sturdy durable construction
- Size: W30 cm x D20 cm x H18 cm

Bur cleaning brushes
Szczotki do czyszczenia wiertel



ST-BUR002
Brass 25 x 70mm
Mosiężna 25 x 70mm



ST-BUR008
Nylon 25 x 70mm
Nylonowa 25 x 70mm



ST-WB022
Brass 4mm
Mosiężna 4mm

SELF-LOCK

Bur stands stainless steel / Podstawki do wiertel ze stali nierdzewnej
Hinged self locking cover. Suitable for ultrasonic baths, disinfectors, autoclaves
(can be placed in pouches).
Samozamykająca przykrywka. Pasują do myjek ultradźwiękowych, dezynfektorów,
autoklawów (mieszczą się w torebki do sterylizacji).



DZ.056.010
For 8 FG burs
Na 8 wiertel na turbinę



DZ.056.020
For 4 FG and 4 CA/RA burs
Na 4 wiertel na turbinę
i 4 na kątnicę



DZ.056.030
For 8 CA/RA burs
Na 8 wiertel na kątnicę

Nest Universal silicone burs stands with cover
Podstawki silikonowe z pokrywką na wiertła i frezy



Autoclavable
Możliwość sterylizacji w autoklawie

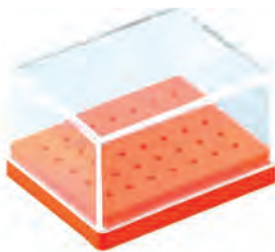

60 x 50 x 35 mm

For 35 FG / RA burs 35mm
Na 35 wiertel FG / RA 35mm

- DZ.064.010 Orange / Pomarańczowa
- DZ.064.020 Red / Czerwona
- DZ.064.030 Yellow / Żółta
- DZ.064.040 Lavender / Lawendowa
- DZ.064.050 Blue / Niebieska
- DZ.064.060 Black / Czarna

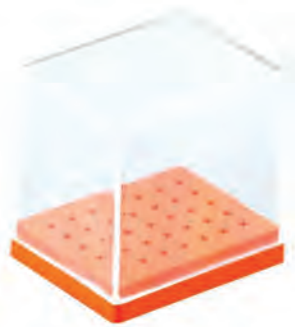

60 x 50 x 60 mm

For 35 HP burs 55mm
Na 35 wiertel HP 55mm

- DZ.064.015 Orange / Pomarańczowa
- DZ.064.025 Red / Czerwona
- DZ.064.035 Yellow / Żółta
- DZ.064.045 Lavender / Lawendowa
- DZ.064.055 Blue / Niebieska
- DZ.064.065 Black / Czarna



D₂₀

Cleaning and Disinfection / Dezynfekcja





Instruments disinfection
Dezynfekcja narzędzi

Viruton® Bohr

Powerful concentrate for cleaning and disinfecting rotary instruments

Application:

Ready to use formulation intended for simultaneous cleaning and didinfection of precision rotary instrument and other medical instruments. It is recommended for didinfection: drills, bone cutters made of steel, hard metals, diamonds, tools, abrasives and polishing agents such as silocone rubber, ceramic tile and toola for root canal treatment. Corrosion inhibitors, making ideal for all of the instruments and stainless steel alloys. It has a pleasant floral scent. It can be applied by immersion in an ultrasonic bath.

Applications references:

Instruments immediately after use immerse in undiluted preparation. Carefully submerge all items. After a certain time remove form tank or washers, rinse in water and immediately dry with a disposable napkin. In case of visible pollutants remove them with a brush and disinfect product again in preparation. Do not mix with other detergents or disinfectants. Do not use on aluminium

Zastosowanie:

Viruton Bohr zalecany jest do dezynfekcji: wiertel, frezów kostnych ze stali, twardych metali, diamentów, narzędzi ściernychi polejujących takich jak: gumki silikonowe, płytki ceramiczne oraz narzędzi do leczenia kanałowego. Zawiera inhibitor korozji, dzięki czemu idealnie chroni instrumenty ze stali i stopów metali. Może być stosowany do narzędzi aluminiowych. Posiada bardzo dobre właściwości myjące, również w przypadku zaschniętych pozostałości organicznych. Może być stosowany poprzez zanurzenie wanny do dezynfekcji lub w myjce ultradźwiękowej.

Sposób użycia:

Narzędzia bezpośrednio po użyciu zanurzyć w nierozcieńczonym preparacie. Starannie zanurzyć wszystkie elementy. Po określonym czasie działania narzędzia wyjąć z wianienki lub myjki, wypłukać w wodzie i natychmiast osuszyć jednorazową serwetką. W razie widocznych zanieczyszczeń usunąć je szczoteczką, a dezynfekowany wyrób zanurzyć ponownie w preparacie. Po osuszeniu czyste narzędzia poddać sterylizacji. Nie łączyć z innymi środkami czyszczącymi lub dezynfekującymi. Nie stosować na aluminium.

Skład:

amina, czwartorzędowy związek amonowy, inhibitor korozji

Pack size / Opakowanie:

DZ.1101.01 1 litre bottle / Butelka 1 l z dozownikiem



Viruton® Forte

Concentrate for cleaning and disinfecting surgical instruments

Application:

Viruton Forte is a very effective preparation for simultaneous cleaning and disinfection of all kinds of surgical instrument (except for flexible endoscopes). Viruton Forte has a broad spectrum in low use concentrations. The use of corrosion inhibitors ensures high material compatibility with instruments made of stainless steel and aluminium, medical devices and laboratory glass, porcelain, metal, rubber and plastics.

Applications references:

The concentrate must be diluted before use with water to the desired concentration for the specified table. 1 liter bottle includes an integrated dispenser: 10 ml at 1 liters of water gives a concentration of 1%. Instruments immediately after use immerse in the solution. All parts and holes must be completely filled with the solution. Before the first use of the preparation instruments should be washed with clean water so that it does not come into contact with other agents.

Koncentrat do mycia i dezynfekcji narzędzi

Zastosowanie:

Viruton Forte posiada bardzo dobre właściwości czyszczące i szerokie spektrum bójcze w krótkim czasie działania. Przeznaczony jest do manualnej dezynfekcji narzędzi oraz dezynfekcji w myjkach ultradźwiękowych. Produkt wykazuje właściwości antykorozyjne i wysoką tolerancję materiałową. Jest zalecany do dezynfekcji instrumentów ze stali szlachetnej, niklu, miedzi, aluminium, gumy, porcelany, szkła i tworzywa sztucznego.

Sposób użycia:

Koncentrat przed użyciem należy rozcieńczyć wodą. Instrumenty bezpośrednio po użyciu zanurzyć w roztworze. Wszystkie części i otwory muszą być całkowicie wypełnione roztworem. Nie łączyć z innymi środkami czyszczącymi lub dezynfekującymi. Przed pierwszym zastosowaniem preparatu Viruton Forte instrumenty należy umyć czystą wodą, aby nie doszło do kontaktu z innymi środkami. Pozostałości innych substancji w wannie mogą powodować w początkowej fazie stosowania mętnienie roztworu. Nie wpływa to na jakość procesu dezynfekcji, a jedynie na efekt wizualny. W przypadku użycia wody o dużym stopniu twardości na dnie roztworu może pojawić się delikatny osad. Nie zmienia to właściwości wyrobu i nie wpływa na jakość procesu dezynfekcji.

Skład:

propyloamina, czwartorzędowe związki amonowe, inhibitory korozji

Pack size / Opakowanie:

DZ.1101.02 1 litre bottle / Butelka 1 l z dozownikiem





Instruments disinfection Dezynfekcja narzędzi

Viruton® Extra

Powerful concentrate for cleaning and disinfecting medical instruments

Application:

Viruton Extra is a highly effective preparation for simultaneous cleaning and disinfection of all kinds of thermo labile and thermo stable surgical instrument (except for flexible endoscopes). Modern formula provides excellent cleaning effects even at high protein load in a short duration of action. Viruton Extra has a broad spectrum in very low use concentrations. The use of corrosion inhibitors ensures high material compatibility with instruments made of stainless steel and aluminium, medical devices and laboratory glass, porcelain, metal, rubber and plastics.

Applications references:

The concentrate must be diluted before use with water to the desired concentration for the specified table. 1 liter bottle includes an integrated dispenser: 5 ml at 1 liters of water gives a concentration of 0,5%. Instruments immediately after use immerse in the solution. All parts and holes must be completely filled with the solution. Before the first use of the preparation instruments should be washed with clean water so that it does not come into contact with other agents.

Enzymatyczny koncentrat do mycia i dezynfekcji narzędzi

Zastosowanie:

Viruton Extra to wydajny, enzymatyczny koncentrat przeznaczony do jednoczesnego mycia i dezynfekcji instrumentów chirurgicznych i rotacyjnych. Zawiera enzym - proteazę, dzięki czemu wykazuje bardzo dobre właściwości czyszczące. Skutecznie usuwa zaschnięte zabrudzenia organiczne. Przeznaczony jest do manualnej dezynfekcji narzędzi oraz dezynfekcji w myjkach ultradźwiękowych. Produkt wykazuje właściwości antykorozyjne i wysoką tolerancję materiałową. Jest zalecany do instrumentów ze stali szlachetnej, niklu, miedzi, aluminium, gumy, porcelany, szkła i tworzywa sztucznego. Dzięki innowacyjnej formule opartej na synergii surfaktantów i technologii nano-miceli produkt posiada szerokie spektrum bójcze i wyjątkowe właściwości myjące.

Sposób użycia:

Przygotować roztwór użytkowy koncentratu poprzez rozcieńczenie z wodą w odpowiedniej proporcji. Wybór stężenia zależy od pożądanego spektrum i czasu działania. W celu otrzymania stężenia 0,5% należy 5 ml koncentratu rozpuścić w 995 ml wody. Instrumenty bezpośrednio po użyciu zanurzyć w roztworze. Wszystkie części i otwory muszą być całkowicie wypełnione roztworem. Po dezynfekcji, instrument wypłukać i wysuszyć. Aktywność nieskażonego roztworu roboczego wynosi 14 dni. Ze względów higienicznych zaleca się codzienną wymianę roztworu. Nie łączyć z innymi środkami czyszczącymi lub dezynfekującymi. Wyrób przeznaczony do zastosowania przez profesjonalnego użytkownika.

Skład:

propyloamina, czwartorzędowe związki amonowe, inhibitory korozji

Pack size / Opakowanie:

DZ.1101.03 1 litre bottle / Butelka 1 l z dozownikiem



Viruton® Pulver

Powerful concentrate for cleaning and disinfecting medical instruments

Application:

Viruton Extra is a highly effective preparation for simultaneous cleaning and disinfection of all kinds of thermo labile and thermo stable surgical instrument (except for flexible endoscopes). Modern formula provides excellent cleaning effects even at high protein load in a short duration of action. Viruton Extra has a broad spectrum in very low use concentrations. The use of corrosion inhibitors ensures high material compatibility with instruments made of stainless steel and aluminium, medical devices and laboratory glass, porcelain, metal, rubber and plastics.

Applications references:

The concentrate must be diluted before use with water to the desired concentration for the specified table. 1 liter bottle includes an integrated dispenser: 5 ml at 1 liters of water gives a concentration of 0,5%. Instruments immediately after use immerse in the solution. All parts and holes must be completely filled with the solution. Before the first use of the preparation instruments should be washed with clean water so that it does not come into contact with other agents.

Proszek do mycia i dezynfekcji narzędzi, endoskopów, inkubatorów i innych powierzchni wyrobów medycznych

Zastosowanie:

Viruton Pulver to nowoczesnej generacji preparat do mycia i dezynfekcji wysokiego stopnia inwazyjnych i nieinwazyjnych wyrobów medycznych. Jest zalecany do instrumentów chirurgicznych, dentystycznych oraz wszelkiego rodzaju endoskopów, sond chirurgicznych, rurek do respiratorów i innych urządzeń anestetycznych. Może być również stosowany do dezynfekcji powierzchni sprzętu medycznego, jak np. inkubatory. Zalecany jest do dezynfekcji manualnej, w myjkach ultradźwiękowych, myjniach automatycznych oraz w myjkach do endoskopów. Produkt nie wymaga dodania aktywatora. Innowacyjna formuła zawiera cztery enzymy (proteazę, lipazę, amylazę i mannazę) odpowiedzialne za usuwanie zanieczyszczeń organicznych takich jak krew, białko, tłuszcze, wydzieliny. Zawartość surfaktantów zapobiega pyleniu proszku i gwarantuje doskonałe właściwości myjące.

Spektrum:

Szczegółowe informacje zawarte w ulotce produktowej.

Skład:

100 g preparatu zawiera: 44g nadwęglan sodu (CAS: 15630-89-4), 26g TEAD (CAS: 10543-57-4), enzymy, kwasy organiczne, niejonowe środki powierzchniowo czynne, inhibitory korozji

Pack size / Opakowanie:

DZ.1101.12 1 kg





Cleaning and Disinfection Dezynfekcja

Instruments disinfection Dezynfekcja narzędzi

Viruton® Strong

Concentrate for cleaning and disinfection

Applications references:

Viruton Strong is a high-end Solution for disinfection and cleaning instruments with a new active substance, which is characterized by a short contact time and use in low concentrations. This product has great cleaning properties, with broad spectrum of biocide action. It is aldehyde- and phenol free and contains corrosion inhibitors for your instruments safety. It is very suitable for disinfecting laboratory utensils and medical instruments of glass, porcelain, metal, rubber, plastics. Concentrate should be diluted with cold clean water to obtain the desired concentration. The instruments must be immersed in the solution immediately after use. All surfaces and cavities of instruments should be covered completely with working solution. After expiry time of disinfection, instruments must be rinsed with water and dried. Working solution is stable and active 14 days.

Wydajny koncentrat do mycia i dezynfekcji narzędzi

Zastosowanie:

Viruton Strong to wysoce skuteczny preparat do jednoczesnego mycia i dezynfekcji wszelkiego rodzaju termolabilnych i termostabilnych instrumentów chirurgicznych (za wyjątkiem endoskopów giętkich). Nowoczesna formuła gwarantuje doskonałe efekty czyszczące nawet przy wysokim obciążeniu białkowym w krótkim czasie działania. Viruton Strong posiada szerokie spektrum bójcze w bardzo niskich stężeniach użytkowych. Zastosowanie inhibitorów korozji gwarantuje wysoką tolerancję materiałową instrumentarium oraz wyrobów medycznych i przyrządów laboratoryjnych ze szkła, porcelany, metalu, gumy i tworzyw sztucznych. Roztwór preparatu posiada przyjemny zapach. Aktywność nieużywanego oraz używanego roztworu roboczego wynosi 14 dni. Może być stosowany w myjce ultradźwiękowej.

Skład:

100 g zawiera:
- 19,05 g N-(3-aminopropyl)-N-dodecylopropano-1,3-diamina;
- 5,60 g Poli(oksy-1,2-etanodiol), alfa-[2-(didecylmetyloamino)etylo]-omega-hydrokso-, propanian (sól);
- 2,10 g 2(2-butoksyetoksy)etanol.

Pack size / Opakowanie:

DZ.1101.04 1 L bottle with dispenser / Butelka 1 L z dozownikiem



Surface disinfection Dezynfekcja powierzchni

Velox® Top AF

Ready-to-use formulation for cleaning and disinfection of surfaces of medical equipment

Velox Top AF is a ready-to-use formulation with a wide spectrum in microbiological activity combined with short contact times as well as highly effective cleaning and material preserving properties.

Applications references:

This ready-to-use rapid disinfection liquid shall be sprayed from a distance of 20-30 cm onto the surfaces or objects to be disinfected and evenly spread with a lintfree, uncolored disposable cloth. Ensure that the disinfected surfaces are completely moistened. After application, allow the disinfectant for 15 minutes to take effect or in accordance with the exposure times listed below. In the event of strongly contaminated surfaces, use additional cleaner, but do not mix with other cleaning agents or disinfectants.

Alkoholowy gotowy do użycia preparat do dezynfekcji i mycia powierzchni nieinwazyjnych wyrobów medycznych

Zastosowanie:

Velox Top AF zalecany jest do szybkiej dezynfekcji powierzchni nieinwazyjnych wyrobów medycznych takich jak: łóżka i fotele zabiegowe, stoły operacyjne, wózki do przewożenia chorych, aparatura medyczna i operacyjna. Polecany jest również do dezynfekcji końcówek stomatologicznych przed procesem sterylizacji oraz łyżek protetycznych i wycisków silikonowych. Preparat nie zawiera aldehydu i fenolu dzięki czemu nie odbarwia dezynfekowanych powierzchni. Dzięki innowacyjnej formule opartej na synergii surfaktantów i technologii nano-miceli produkt posiada szerokie spektrum bójcze i wyjątkowe właściwości myjące

Skład:

propan-2-ol, alkohol etylowy, aminy, QAV

Pack size / Opakowanie:

DZ.1102.01 1L DUO spray bottle / Butelka 1 l ze spryskiwaczem





Surface disinfection Dezynfekcja powierzchni

Velox® Wipes

Alcohol-based-formulation wipes for cleaning and disinfection of surfaces of medical equipment

Presaturated with an alcohol-based formulation, Velox Wipes is a cleaner and disinfectant in one. Dedicated for rapid disinfection of small surfaces of medical equipment, chairs, beds, dental ends before the sterilisation process and prosthetic spoons and silicon moulds. Also recommended for surfaces having contact with food. Free from aldehyde and phenol, does not discolour disinfected surfaces. It has as a pleasant grapefruit-and-mandarin scent. Tested and recommended by Famed - a leading European producer of top quality hospital equipment.

Applications references:

Take a tissue from the tub and wipe a surface to be cleaned and disinfected. Close the lid. After opening the packaging, use the tissues within 21 days. Do not use if a tissue is dry. Do not use on sensitive to alcohols areas (e.g. acrylic glass). The product is intended for use by professional users.

Active ingredients: amine, quaternary ammonium compounds

Alkoholowe chusteczki przeznaczone do mycia i szybkiej dezynfekcji powierzchni nieinwazyjnych wyrobów medycznych

Zastosowanie:

Chusteczki Velox® Wipes zalecane są do mycia i szybkiej dezynfekcji nieinwazyjnych wyrobów medycznych: łóżek i foteli zabiegowych, aparatury medycznej. Polecane jest również do dezynfekcji końcówek stomatologicznych przed procesem sterylizacji oraz łyżek protetycznych i wycisków silikonowych. Preparat nie zawiera aldehydu i fenolu dzięki czemu nie odbarwia dezynfekowanych powierzchni. Dzięki innowacyjnej formule opartej na synergii surfaktantów i technologii nano-miceli produkt posiada szerokie spektrum bójcze i wyjątkowe właściwości myjące. Posiadają pozytywną opinię producenta sprzętu medycznego Famed. Posiadają przyjemny świeży zapach.

Skład:

amina, czwartorzędowy związek amonowy

Pack size / Opakowanie:

DZ.1102.02 Plastic box with 100 wipes / Puszka 100 szt
DZ.1102.03 Refill bag with 100 wipes, / Wkład 100 szt

Size / Rozmiar. 13 x 20 cm, 23 g/m²



Hand disinfection Dezynfekcja rąk i skóry

AHD 1000 Sterisol

Alcohol gel to surgical and hygienic hand disinfection . Microbiologically clean the entire period of use . It does not contain preservatives, and dyes.

Gel formula allows for precise spreading and rubbing the product into the skin
Exhibits an immediate and prolonged effect confirmed by tests
Has a broad spectrum biocides - fights bacteria , mycobacteria , fungi and viruses
Exhibits effective action even in the presence of organic pollutants
Manufactured under aseptic conditions
Microbiological purity of the product throughout the period of use is guaranteed
A special valve - the patented valve system to prevent suction of air into the bag along with microorganisms
S pipe - valve has created a product that does not contain bacteriostatic substances and preservatives , which are often the cause of allergies and skin irritations
Recommended for frequent use for people with very sensitive skin and tendency to allergies and prevent dry skin - contains moisturizers
Works very gentle on the skin, leaves no chemical substances aggravating and irritating to the skin

Alkoholowy płyn do dezynfekcji rąk.

- 1 Przeznaczony do dezynfekcji rąk przed zabiegami przebiegającymi z naruszeniem ciągłości tkanek
- 2 Posiada szerokie spektrum biobójcze wobec bakterii, prątków, grzybów i wirusów – inaktywacja wirusa Polio w 1 minutę!
- 3 Wykazuje natychmiastowe i przedłużone działanie dezynfekujące
- 4 Oparty na bazie alkoholu etylowego, który charakteryzuje się wysoką skutecznością biobójczą i niską toksycznością
- 5 Dodatek substancji nawilżających chroni skórę przed utratą wody nawet z najgłębszych warstw
- 6 Obecny olejek zapachowy neutralizuje charakterystyczny zapach alkoholu - czyniąc preparat bardziej przyjemnym i ulotnym
- 7 Starannie dobrana kompozycja składników zapewnia pielęgnacyjny wpływ na naskórek
- 8 Polecany do dezynfekcji skóry wrażliwej i skłonnej do alergii
- 9 Dobrze tolerowany przy częstym stosowaniu
- 10 Po użyciu nie pozostawia uczucia lepkich dłoni
- 11 Bardzo dobrze odświeża skórę

Pack size / Opakowanie:

DZ.1103.03 AHD 1000 Sterisol – bag 700 ml / AHD 1000 Sterisol – worek 700 ml





Velodes Gel

Zastosowanie: Velodes® Gel to żel przeznaczony do higienicznej i chirurgicznej dezynfekcji rąk. Wykazuje działanie bakteriobójcze, drożdżakobójcze, bójcze wobec prątków gruźlicy i ograniczone wirusobójcze. Działa na wirusy osłonkowe takie jak: Vaccinia, BVDV, HIV, HBV, HCV oraz wirusy Rota i Noro. Łagodny dla dłoni, zawiera substancję pielęgnującą – glicerynę. Dzięki specjalnej formule zapobiega uczuciu lepkości dłoni. Żel przebadany dermatologicznie.

Dezynfekcja MEDISEPT jest SKUTECZNA wobec KORONAWIRUSA

Żel do higienicznej i chirurgicznej dezynfekcji rąk

- Cechy produktu:
- Higieniczna dezynfekcja rąk: 2 x 3 ml w 30 sek
- Chirurgiczna dezynfekcja rąk: 2 x 3 ml w 3 min
- Skuteczny wobec wirusów Rota i Noro
- Łagodne dla skóry pH
- Zawiera substancję pielęgnującą – glicerynę
- Przebadany dermatologicznie
- Gwarancja skuteczności potwierdzona badaniami
- Nawilża i pielęgnuje dłonie
- Wygodny w użyciu
- Szybkie działanie
- Zapobiega uczuciu lepkości dłoni



Packaging / Opakowanie:

DZ.1103.07 Bottle 500 ml / butelka 500 ml

Velodes Silk

Velodes® Silk is a solution ready for use to be applied on hands as an alcoholic disinfectant for hygienic and surgical use. Exposure time from 30 seconds. Contains glycerine that keeps the skin moist, has neutral pH and a good skin tolerance. The product has a prolonged 3-hour surgical disinfection effect. New formule – smooth hands. Dermatologically tested.

Directions for use:

Hygienic hand disinfection (according to EN 1500): 2 x 3 ml of the product to be rubbed in hands for 30 seconds. Surgical hand disinfection (according to EN 12791): 2 x 3 ml of the product to be rubbed in clean and dry hands for 180 seconds. Keep hands equally moistured by adding more liquid. The product also has a prolonged 3-hour surgical disinfection effect. Read technical sheet before application. The product dedicated for professional use.

Active ingredients:

Propan-2-ol, chlorhexidine gluconate

Płyn do higienicznej i chirurgicznej dezynfekcji rąk

Cechy produktu:

- Higieniczna dezynfekcja rąk: 2 x 3 ml w 30 sek
- Chirurgiczna dezynfekcja rąk: 2 x 3 ml w 3 min
- Skuteczny wobec wirusów Rota, Noro, SARS-Cov-2
- Łagodne dla skóry pH
- Zawiera substancję pielęgnującą – glicerynę
- Przebadany dermatologicznie
- Gwarancja skuteczności potwierdzona badaniami
- Nawilża i pielęgnuje dłonie
- Wygodny w użyciu
- Szybkie działanie
- Zapobiega uczuciu lepkości dłoni



Packaging / Opakowanie:

DZ.1103.08 Bottle 500 ml / butelka 500 ml
DZ.1103.09 Bottle 1 litre / Butelka 1 litre

Dispenser / Dozowniki



DZ.1104.01
For 700 ml bags

Instruments disinfectant tub / Wanienki do dezynfekcji



Code / Kod	Outer size Roz zewnętrzne	Inner size Roz wewnętrzne	Pojemność
DZ.1100.01	220 x 150 x 85mm	150 x 125 x 70mm	1L
DZ.1100.02	315 x 206 x 125mm	260 x 175 x 100mm	3L
DZ.1100.03	394 x 260 x 155mm	320 x 215 x 145mm	5L
DZ.1100.04	496 x 328 x 195mm	400 x 270 x 185mm	10L

D21

Clinic Accessories / Wyposażenie do gabinetu





Dental stools / Stołki stomatologiczne



CF.1100.01

Height adjustable dental stool with procedure arm and foot rest ring



CF.1101.01

Height adjustable lab stool with foot rest ring



CF.1102.01

Height adjustable lab stool with foot rest



CF.1103.01

Height adjustment lab stool
Stolek Obrotowy na Śrubie



CF.1104.01

Stool with screw height adjustment
Stolek Obrotowy na Śrubie

Artificial leather / Skaje

Colors available:
Dostępne kolory:



G-27



G-29



G-03



G-27



G-05



G-06



G-07

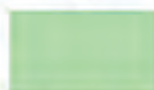

G-26



G-09



G-10



G-11



G-30



G-13



G-14



G-15



G-16



G-17



G-18



G-19



G-20



G-21



G-22



G-23



G-24



G-25



Clinic trolleys / Stoliki



CF.1500.01
870 x 400 x 475 mm



CF.1500.02
870 x 400 x 475 mm



CF.1500.05
820 x 440 x 610 mm

Delivery time will be in 14 working days from order date / Czas realizacji zamówienia: 14 dni

Dental mobile cabinets / Asystory stomatologiczne



Asystor III
500 x 425 x 900 to 1080mm



Asystor IV
500 x 425 x 940 to 1080mm



Asystor V
500 x 425 x 835mm

Available colors/ Dostępne kolory



Red / Gładki czerwony



Green / Gładki zielony



Green / Połysk zielony



Orange / Połysk Pomarańczowy



Silver / Srebrna



White / Połysk biały

Delivery time will be in 14 working days from order date / Czas realizacji zamówienia: 14 dni

Universal trays insert for mobile cabinets / Wkłady do szuflad (uniwersalne)



DQ.9105.01
500 x 520 mm



DQ.9105.02
500 x 520 mm



DQ.9105.03
500 x 520 mm



Clinic accessories
Wyposażenie do gabinetu

Child booster seat for dental chair
Siedzisko dla dzieci na fotel stomatologiczny



Size / Wymiary:
szer. 36cm, dł. 40cm, wys. 11 cm



Available colors Dostępne kolory	Code / Kod
	DQ.9101.01
	DQ.9101.02
	DQ.9101.03
	DQ.9101.04
	DQ.9101.05

Universal plastic cover for dental chair
Uniwersalna folia na fotel stomatologiczny



DQ.9104.02	Small / Wąska 63 cm
DQ.9104.01	Medium / średnia 73 cm
DQ.9104.03	Large / Szeroka 82 cm

For covering lower part of dental chair
Do pokrycia całego siedziska dolnego fotela, łatwe mocowanie na gumki

Dental chair cushions
Poduszka ochronna

Idealna ochrona przed uszkodzeniem mechanicznym i przebarwieniem tapicerki fotela
Obustronna tapicerka o rozmiar 53x44cm



Available colors
Dostępne kolory



DQ.9102.01



DQ.9102.02



DQ.9102.03



DQ.9102.04



DQ.9102.05



DQ.9102.06

U shaped neck support
Uniwersalny rogal szyjny dla pacjenta

The U shaped neck support is perfect for sedation dentistry & cosmetic procedures. It provides excellent stability to the head and neck, making it very well suited for sedation dentistry, cosmetic, and endodontic procedures. It gently supports the head and neck, keeping the head in position and preventing discomfort.

Available colors
Dostępne kolory

Wykonany z pianki wiskoelastycznej z pamięcią
Obity skajem wg wzornika
Idealnie dopasowuje się do kształtu szyi pacjenta co tworzy dobre podparcie dla kręgosłupa szyjnego oraz głowy podczas leżenia na fotelu



DQ.9103.01



DQ.9103.02



DQ.9103.03



DQ.9103.04



DQ.9103.05



Biuro i Magazyn

Falcon Medical Polska sp z o.o.
93-575 Łódź, ul. Rembielińskiego 1/7
Poland
Tel: +48 42 630 99 72
Tel: +48 42 632 20 01
Fax: +48 42 630 99 73
www.falconmedical.pl