



10

RETRACTORS

WUNDHAKEN
SEPARADORES
ECARTEURS
DIVARICATORI



Delicate Hooks

Feine Wundhaken
Ganchos

Crochets très fins
Divaricatori sottili

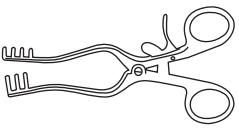

10-002-01



10-002-02



1/4
10-002-03



10-002-04

10-002-01 - 10-002-04
16 cm / 6 1/4"



1/4
10-004-01
sharp



10-004-02
blunt

1/2

Graefe
10-004-01 - 10-004-02
16 cm / 6 1/4"



1/4
10-006-01



10-006-02

1/2
Guthrie
10-006-01 - 10-006-02
16 cm / 6 1/4"



1/2
O'Connor
10-008-16
16 cm / 6 1/4"



1/4

Delicate Hooks

Feine Wundhaken
Ganchos

Crochets très fins
Divaricatori sottili

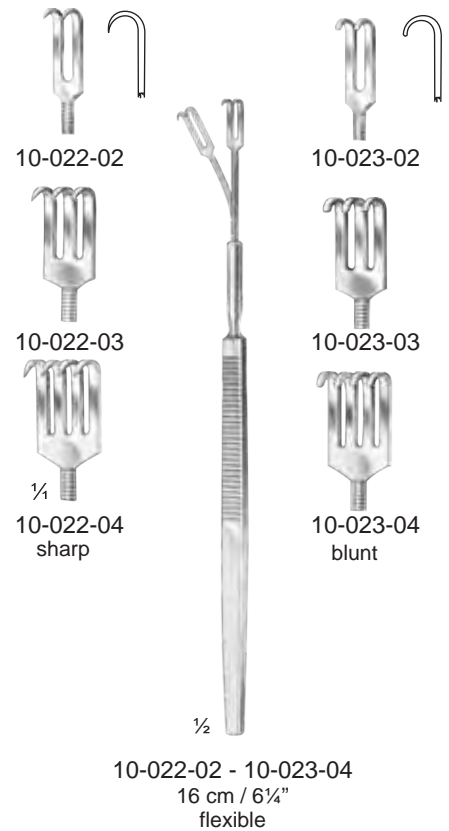
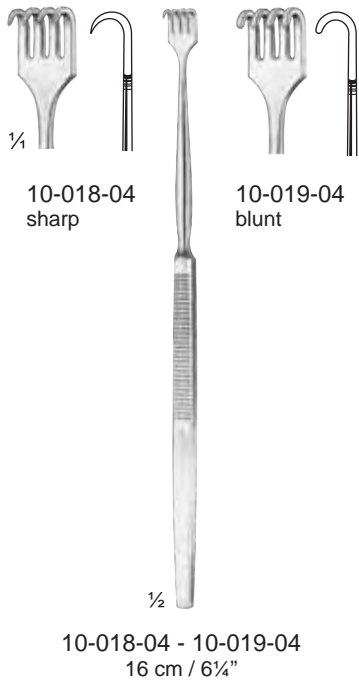
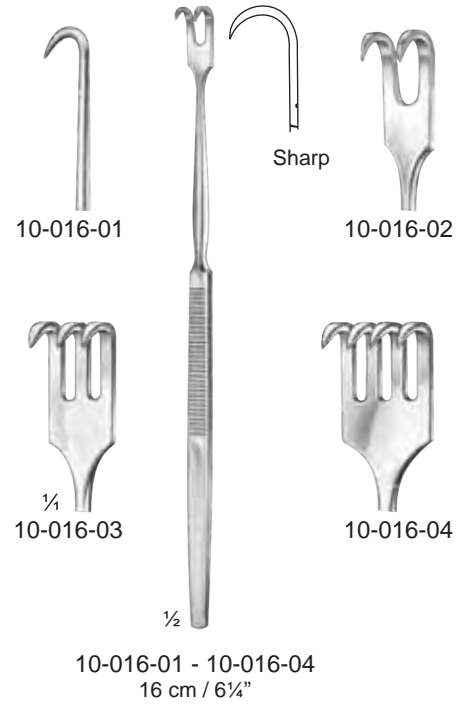
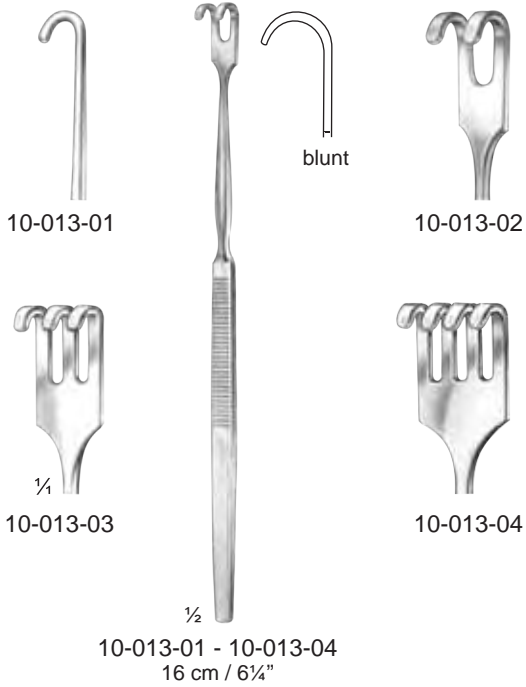
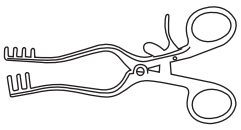

Delicate Hooks

Feine Wundhaken
Ganchos

Crochets très fins
Divaricatori sottili

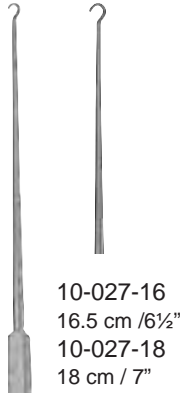
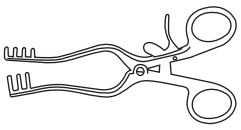

10-027-16
16.5 cm / 6½"
10-027-18
18 cm / 7"



Kliner
10-028-15
15 cm / 6"



Frazier
10-030-13
13 cm / 5"



Kleinert-kutz
10-032-01 - 10-032-03
16 cm / 6¼"

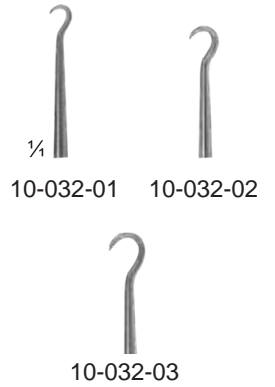

10-032-01 10-032-02

10-032-03



10-034-01



10-034-02

Cushing
10-034-01 - 10-034-02
28 cm / 11"



10-036-01



10-036-02

Cushing
10-036-01 - 10-036-02
19 cm / 7½"



10-038-05
5 mm



10-038-07
7 mm

10-038-05 - 10-038-07
17 cm / 6¾"



10-040-10
1 mm ø



10-040-12
1.2 mm ø

18.5 cm / 7¼"

Delicate Hooks

Feine Wundhaken
Ganchos

Crochets très fins
Divaricatori sottili

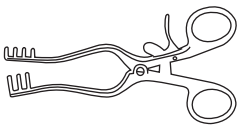

10-045-12
12 mm



10-045-14
14 mm

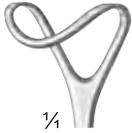

1/4
10-045-16
16 mm



10-045-18
18 mm

1/2

10-045-12 - 10-045-18
16 cm / 6 1/4"



10-047-08
8 mm



10-047-10
10 mm



10-047-12
12 mm



10-047-14
14 mm



1/4
10-047-16
16 mm



10-047-18
18 mm

1/2

Desmarres
10-047-08 - 10-047-18
16 cm / 6 1/4"



10-050-12
12 cm / 4 3/4"



10-052-08
8 mm



10-052-10
10 mm



10-052-12
12 mm



10-052-14
14 mm



10-052-16
16 mm



10-052-18
18 mm

1/2

Desmarres
13 cm / 5"



10-055-10
10 x 6 mm



1/4

10-055-17
17 x 5 mm



10-055-20
20 x 6 mm



10-055-22
22 x 8 mm

1/2

Mini-Langenbeck
10-055-10 - 10-055-22
16 cm / 6 1/4"

Delicate Hooks

Feine Wundhaken
Ganchos

Crochets très fins
Divaricatori sottili

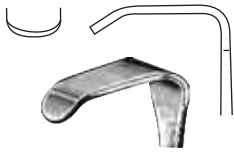
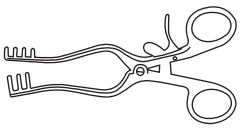

10-061-01
18 x 7 mm

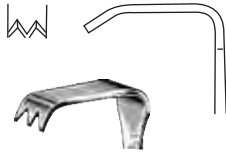

10-061-02
16 x 5 mm



10-061-03
7 x 4 mm



10-061-04
10 x 3 mm



10-061-05
7 x 4 mm

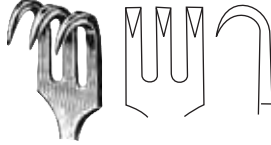

10-061-06
10 x 4 mm



Meyerding
10-061-01 - 10-061-06
18 cm / 7"



10-064-01 - 10-064-04
16 cm / 6 1/4"



10-067-01

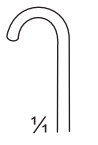

10-067-02



10-067-03



10-067-04



10-067-01 - 10-067-04
16 cm / 6 1/4"



10-070-01



10-070-02



10-070-03



10-070-04



10-070-01 - 10-070-04
16 cm / 6 1/4"

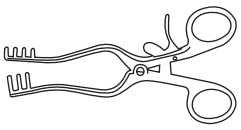

Delicate Hooks

Feine Wundhaken
Ganchos

Crochets très fins
Divaricatori sottili



Rollet
10-074-13
13 cm / 5"



Knapp
10-077-13 - 10-078-13
13 cm / 5"

10-077-13

10-078-13

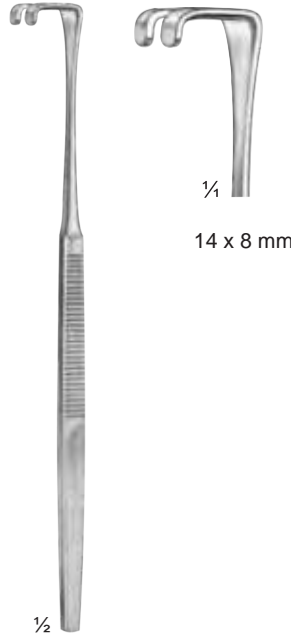

10-081-16
16 cm / 6 1/4"

1/4
14 x 8 mm

1/2



10-083-16
Single Hook
16 cm / 6 1/4"
Blunt

10-085-16
Single Hook
16 cm / 6 1/4"
Sharp

10-083-16 - 10-085-16

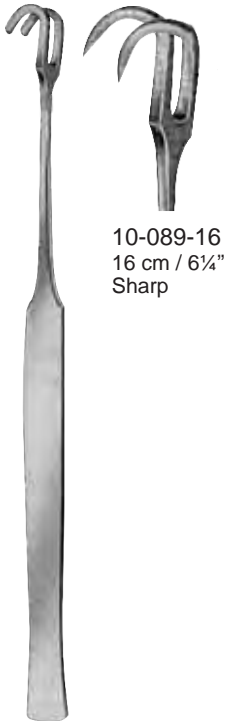

10-089-16
16 cm / 6 1/4"
Sharp



10-091-01
20 x 6 mm



10-091-02
10 x 6 mm

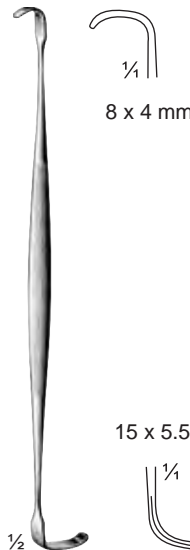

Ragnell-Davis
10-094-14
14 cm / 5 1/2"

1/4
8 x 4 mm

15 x 5.5 mm

1/2

1/4



Kliner
10-097-15
15.5 cm / 6"

10-088-16
Double Hook
16 cm / 6 1/4"
Blunt

Senn-Green
10-091-01 - 10-091-02
15 cm / 6"

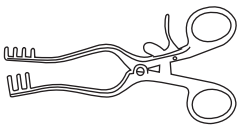

Delicate Retractors, Spinal Retractors

Feine Wundhaken, Spinalhaken
Separadores finas, Separadores espinales

Ecarteurs Fins, Ecarteurs spinals
Divaricatori sottili, Divaricatori spinali



10-102-15
sharp



10-103-15
blunt

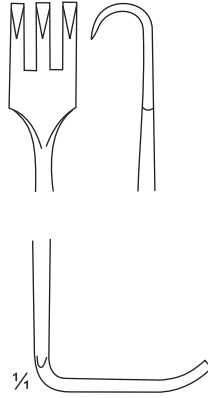

10-106-16
7 x 8.5 cm
Sharp

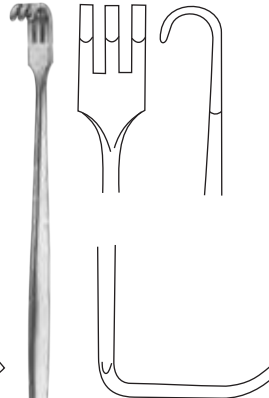

10-107-16
7 x 8.5 cm
Blunt



1/2

Baby-senn-mueller
10-102-15 - 10-103-15
15 cm / 6"

Senn-Mueller
10-106-16 - 10-107-16
16 cm / 6 1/4"

Cushing
10-110-20
20 cm / 8"

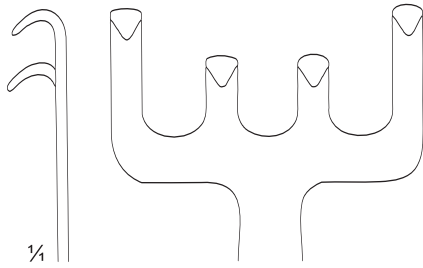

1/4

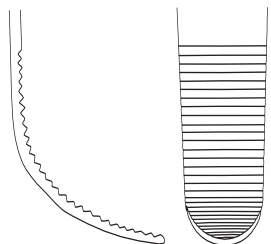

Walter
10-112-19
19 cm / 7 1/2"



Taylor
10-114-07 - 10-114-10
16.5 cm / 6 1/2"

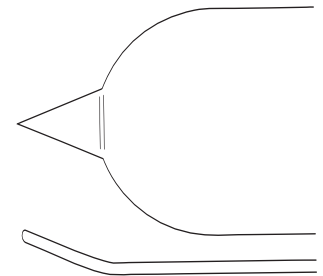

10-114-07
75 x 30 mm

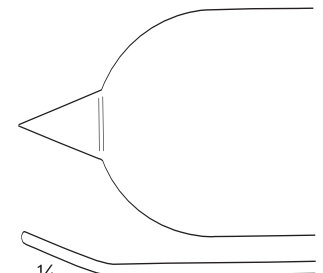

1/4

10-114-10
100 x 30 mm

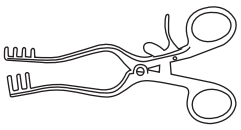

Delicate Hooks

Feine Wundhaken
Ganchos

Crochets très fins
Divaricatori sottili

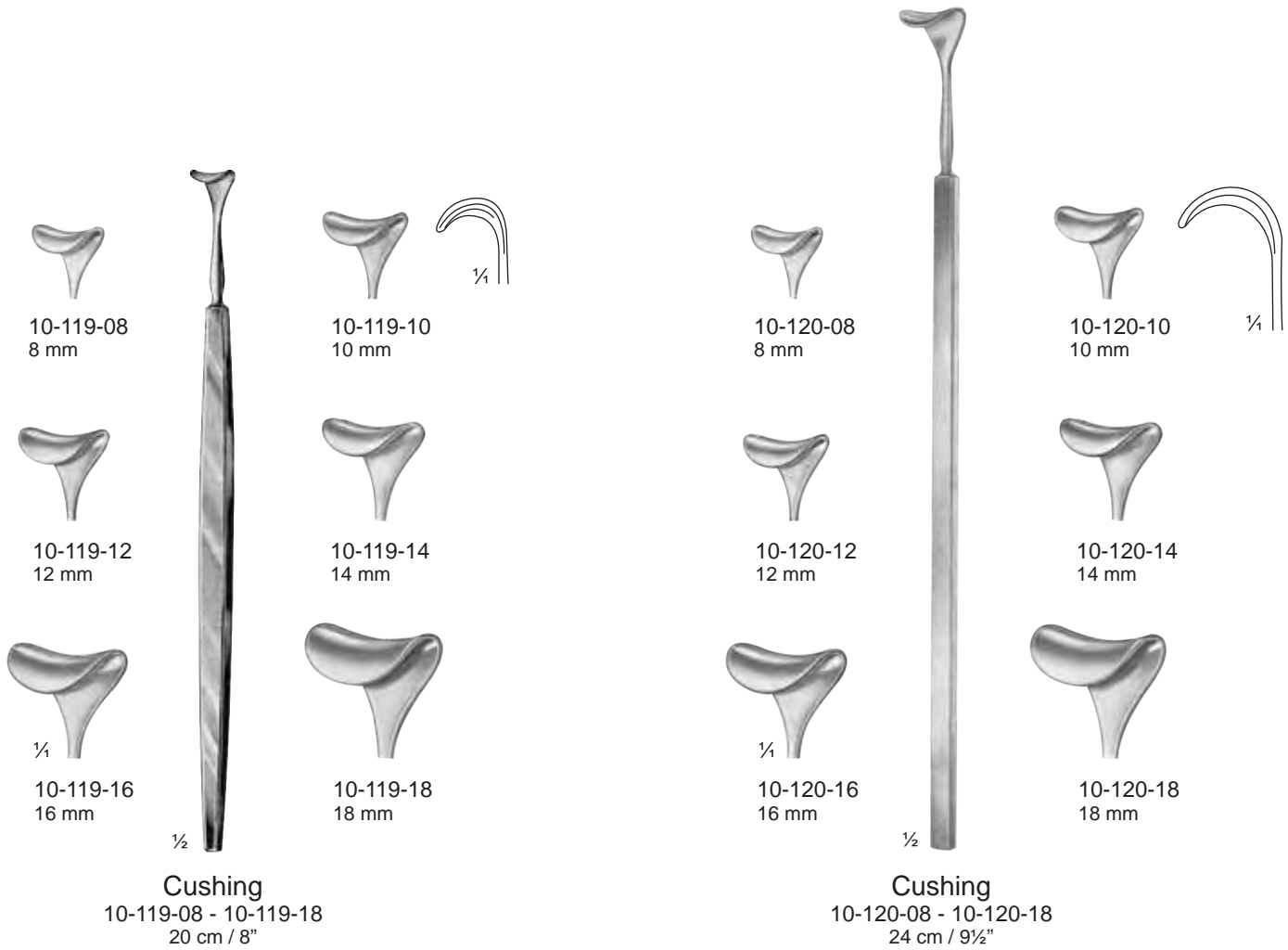

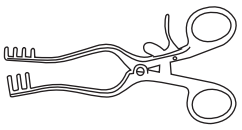

Saddle Hooks

Sattelhäkchen
Ganchos en forma de silla

Ecarteurs sous forme de selle
Divaricatori a forma di sella



10-124-08
8 mm



10-124-11
11 mm



10-124-15
15 mm

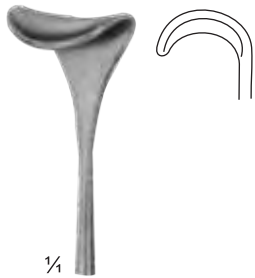

1/4
10-124-17
17 mm



10-124-20
20 mm



10-124-23
23 mm

Gil-Vernet Type
10-124-08 - 10-124-23
24 cm / 9½"

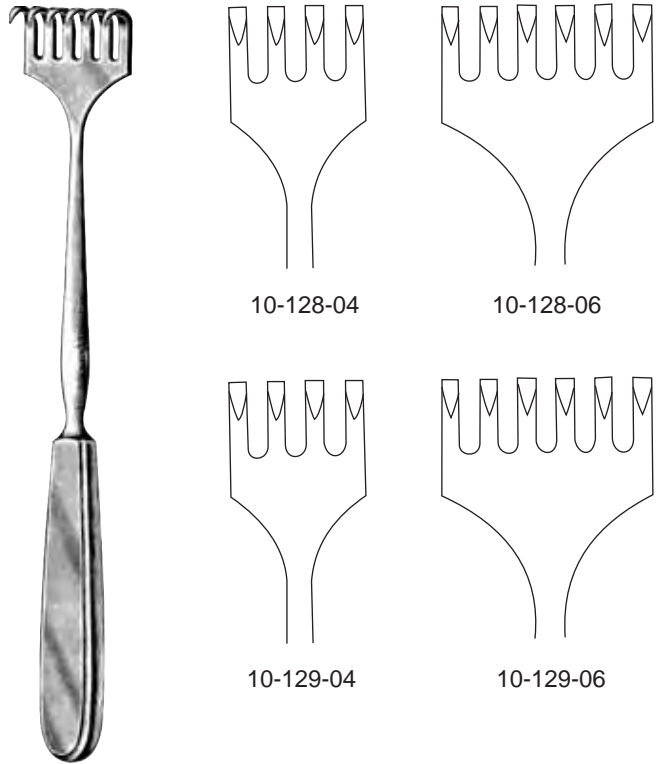
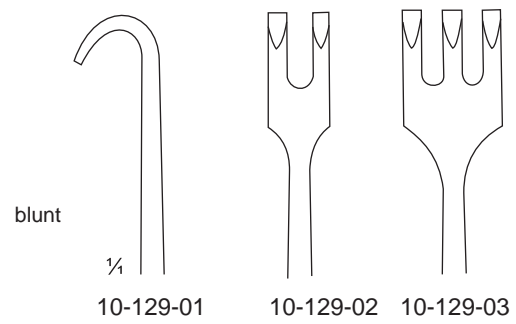
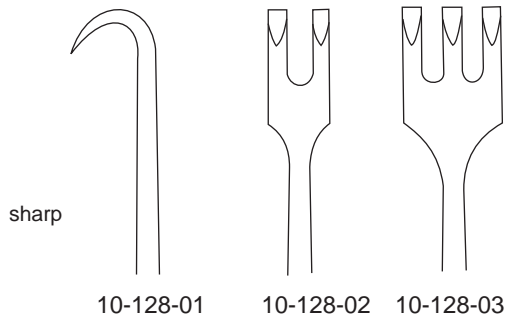
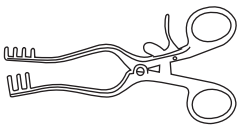

Volkmann
10-128-01 - 10-129-06
23 cm / 9"



Venenhaken Brom
10-132-01 - 10-132-02
19 cm / 7 1/2"



10-132-01



10-132-02



Strandell-Stille
10-135-01 - 10-135-02
19 cm / 7 1/2"

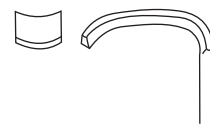

10-135-01

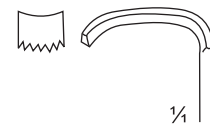

10-135-02
Toothed

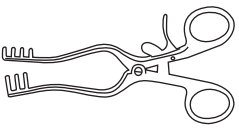

Volkmann
10-140-01 - 10-148-01
21.5 cm / 8½"

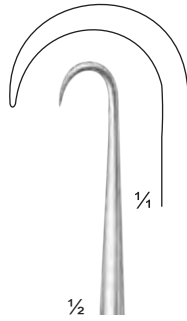



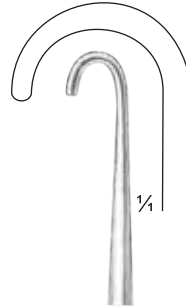



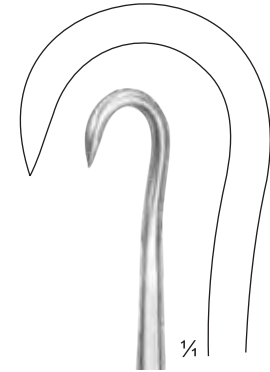











Volkmann
10-146-01
21.5 cm / 8½"



Volkmann
10-147-01
21.5 cm / 8½"



10-148-01
20 cm / 8"
sharp

 10-140-01	 10-140-02	 10-140-03	 10-140-04	 10-140-06	 sharp
 10-141-01	 10-141-02	 10-141-03	 10-141-04	 10-141-06	 blunt
 10-142-01	 10-142-02	 10-142-03	 10-142-04	 10-142-06	 semi-sharp

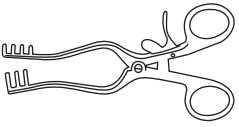

1/2

Kocher

10-152-01 - 10-154-08
22 cm / 8 3/4"



1/2

10-152-01



10-152-02



10-152-03



10-152-04



10-152-06



10-152-08

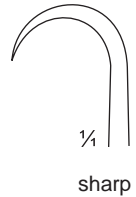

1/4

sharp



1/2

10-153-01



10-153-02



10-153-03



10-153-04



10-153-06



10-153-08

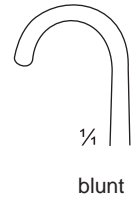

1/4

blunt



1/2

10-154-01



10-154-02



10-154-03



10-154-04



10-154-06



10-154-08

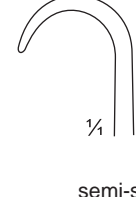

1/4

semi-sharp

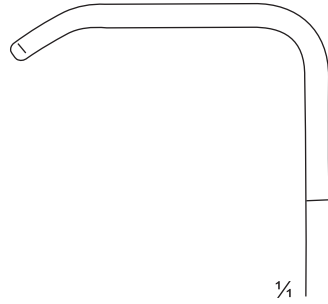
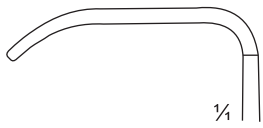
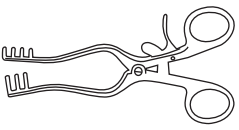

33 x 20 mm

1/2

Wassmund
10-159-02
20 cm / 8"



1/2

10-161-03
36 x 30 mm



10-163-04
36 x 60 mm

Ollier
10-161-03 - 10-163-04
22.5 cm / 9"

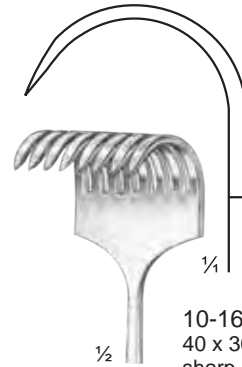

1/2

10-166-08
40 x 30 mm
sharp



1/4

10-167-08
40 x 30 mm
blunt

1/2

Koerte
10-166-08 - 10-167-08
23.5 cm / 9 1/4"

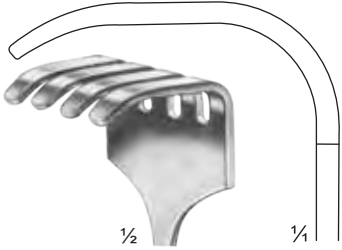
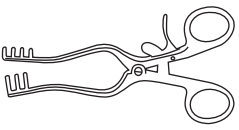

10-171-04
40 X 40 mm

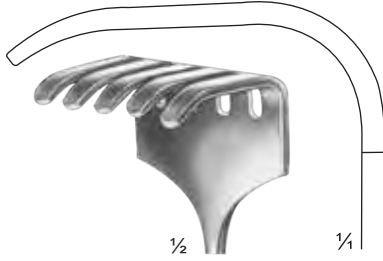

10-173-05
45 X 50 mm



10-179-43
43 x 35mm



10-179-45
45 x 50 mm

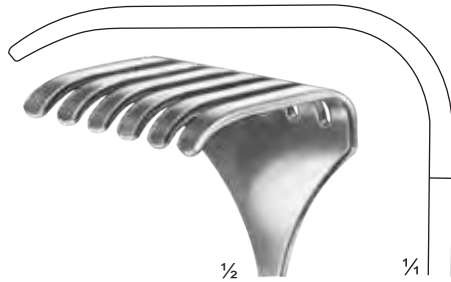

10-175-06
50 X 60 mm



10-179-35
35 x 40 mm

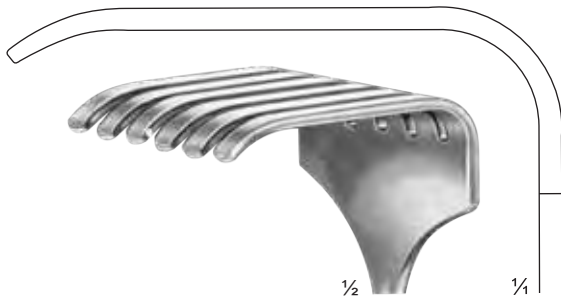

10-177-07
70 X 70 mm

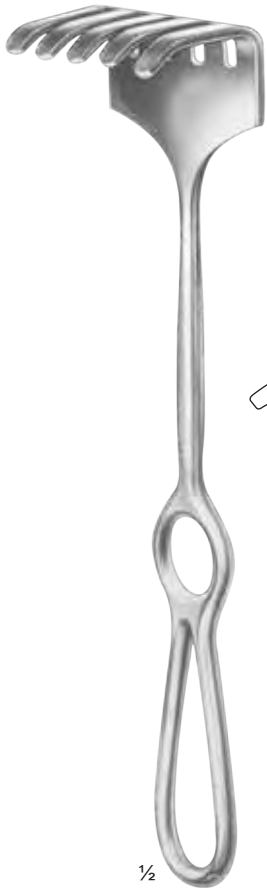

Israel
10-171-04 - 10-177-07
25 cm / 9¾"



Billroth
10-179-35 - 10-179-45
25 cm / 9¾"

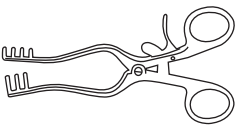

1/2

Langenbeck
10-183-01 - 10-183-05
22.5 cm / 8 3/4"

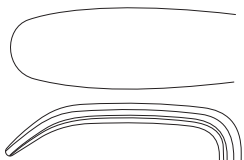

30 X 11 mm
10-183-01
10-185-01 1/4

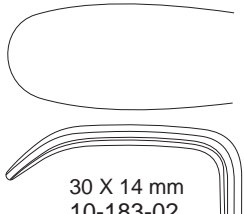

30 X 14 mm
10-183-02
10-185-02 1/4

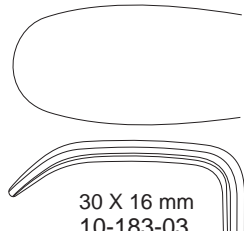

30 X 16 mm
10-183-03
10-185-03 1/4

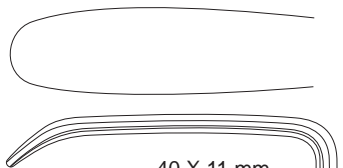

40 X 11 mm
10-183-04
10-185-04 1/4



50 X 11 mm
10-183-05
10-185-05 1/4



1/2

Langenbeck
10-185-01 - 10-185-05
22.5 cm / 8 3/4"

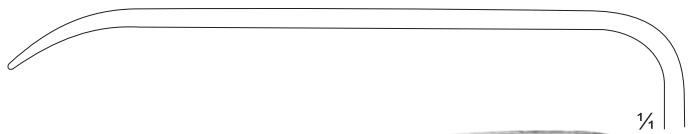
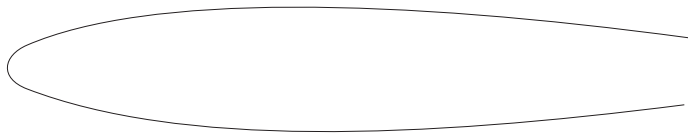
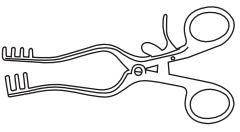

85 X 15 mm

$\frac{1}{4}$

$\frac{1}{2}$

Langenbeck
10-189-20
21 cm / 8 $\frac{1}{4}$ "

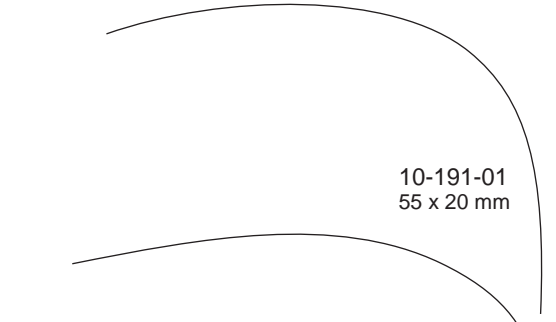

10-191-01
55 x 20 mm

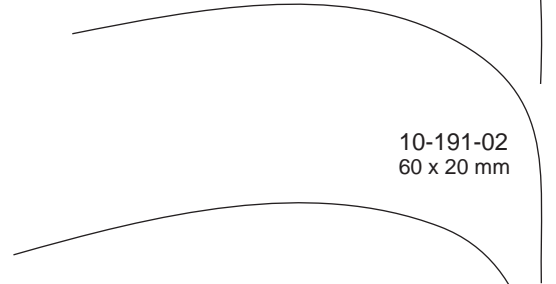

10-191-02
60 x 20 mm

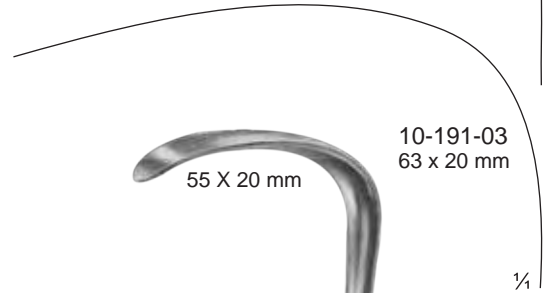

10-191-03
63 x 20 mm

55 X 20 mm

$\frac{1}{4}$

$\frac{1}{2}$

Langenbeck
10-191-01 - 10-191-03
21 cm / 8 $\frac{1}{4}$ "

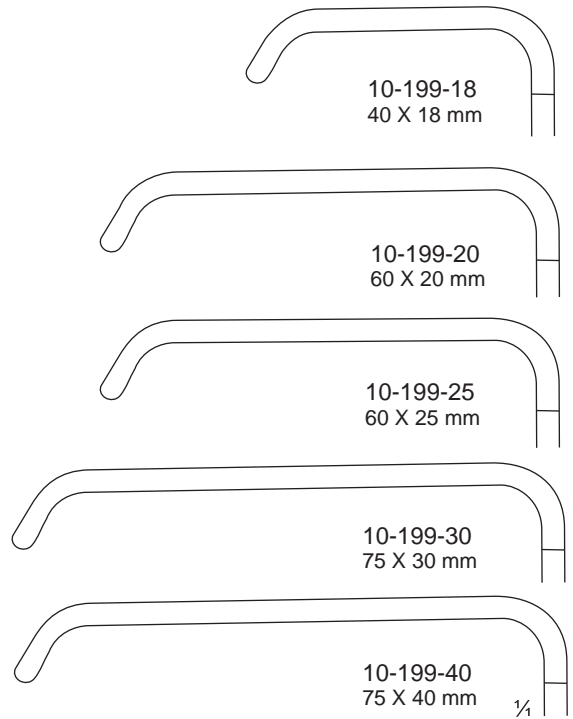
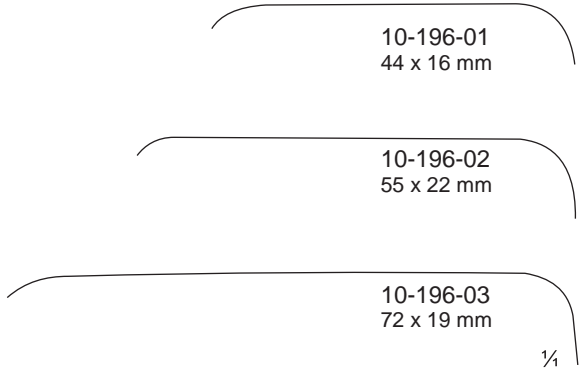
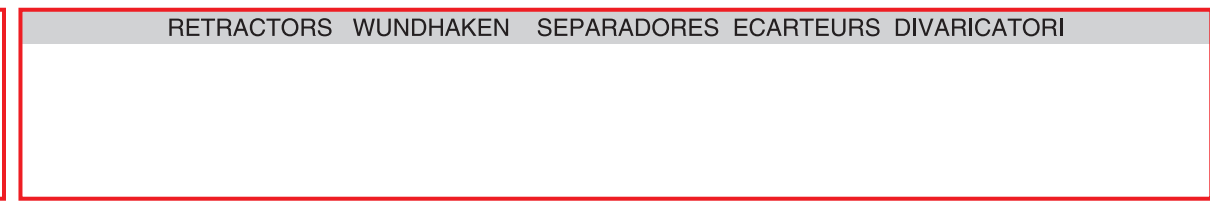
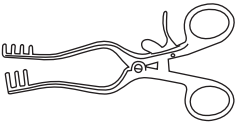

Sauerbruch
10-196-01 - 10-196-03
22.5 cm / 8¾"



Kocher
10-199-18 - 10-199-40
23 cm / 9"

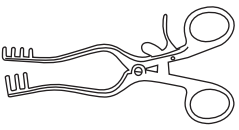

Kocher-Langenbeck
10-203-01 - 10-203-09
21.5 cm / 8½"

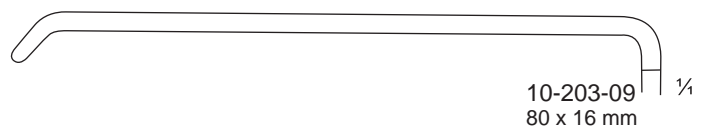
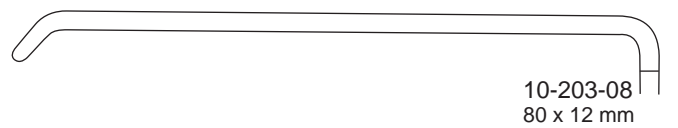
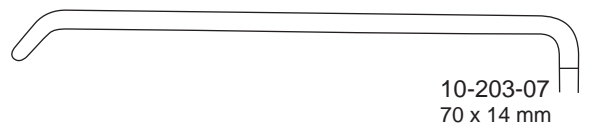
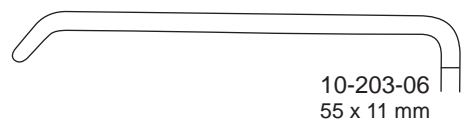
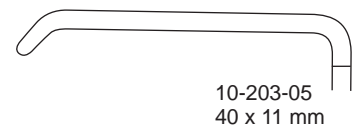
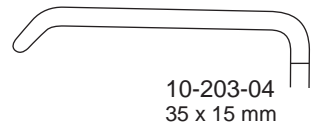
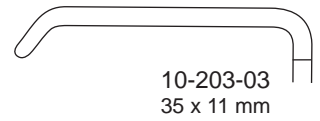
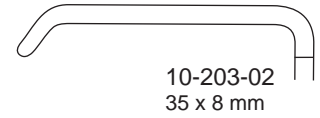
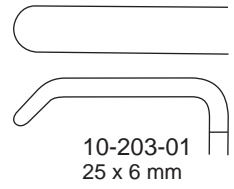

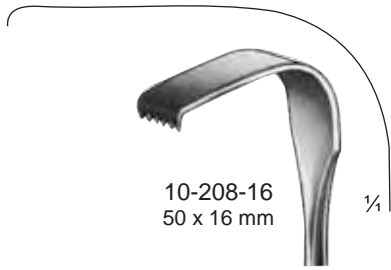
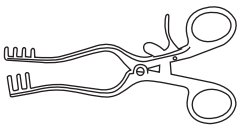

10-208-16
50 x 16 mm

¼

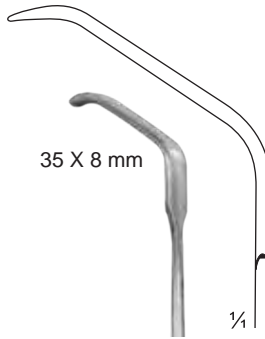

35 X 8 mm

¼

10-211-35
25 cm / 9¾"

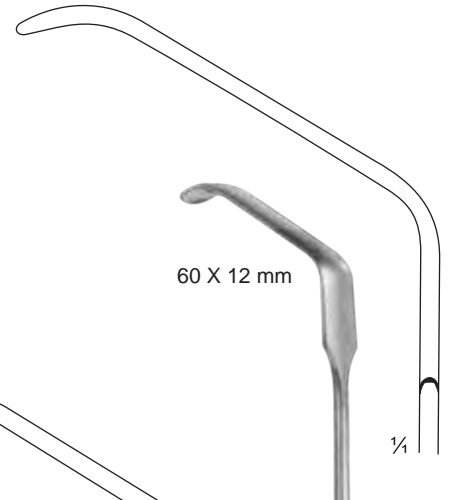

60 X 12 mm

¼

10-211-60
26.5 cm / 10½"

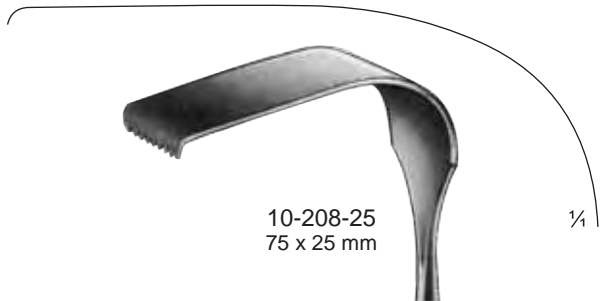

10-208-25
75 x 25 mm

¼

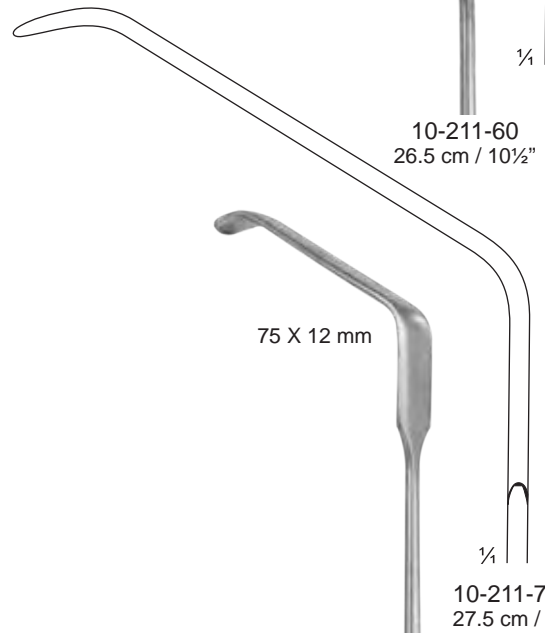

75 X 12 mm

¼

10-211-75
27.5 cm / 10¾"



10-208-50
90 x 50 mm

¼

Meyerdin
10-208-16 - 10-208-50
22.5 cm / 8¾"



½

Zenker
10-211-35 - 10-211-75

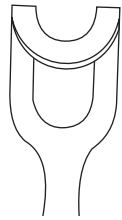
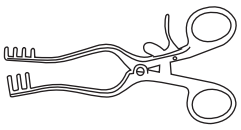

10-215-01
14 x 17 mm
21.5 cm / 8½"

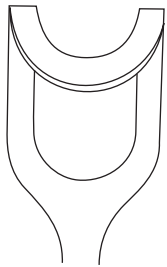

10-215-02
20 x 22 mm
22 cm / 8¾"

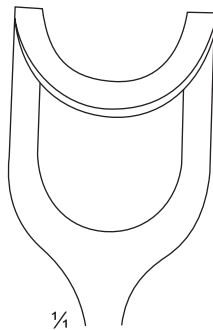

10-215-03
26 x 30 mm
23.5 cm / 9¼"



Middeldorpf
10-215-01 - 10-215-03

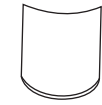
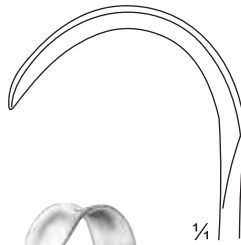

10-217-01
40 x 10 mm



10-217-02
40 x 15 mm

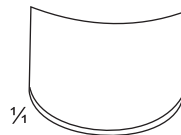

10-217-03
40 x 20 mm



Kocher
10-217-01 - 10-217-03
22 cm / 8¾"

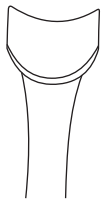
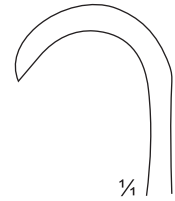

10-219-01
19 x 21 mm

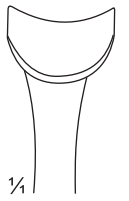

10-219-02
21 x 14 mm



Kocher
10-219-01 - 10-219-02
19 cm / 7½"

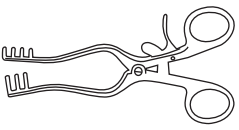

Kelly
10-225-26
26 cm / 10¼"



Richardson
10-227-24
24 cm / 9½"



Richardson
10-229-01 - 10-229-03
24 cm / 9½"

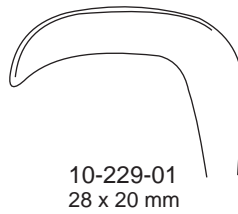

10-229-01
28 x 20 mm

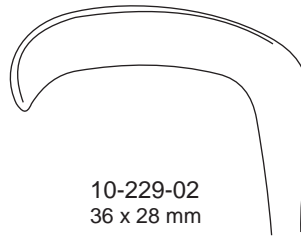

10-229-02
36 x 28 mm

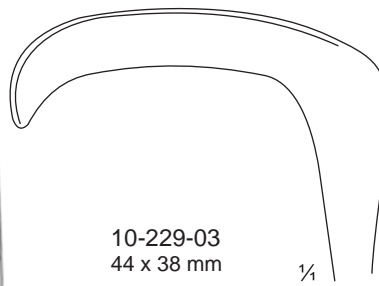

10-229-03
44 x 38 mm



49 X 38 mm
28 X 20 mm

Fig. 1 ▶

◀ Fig. 2

Richardson-Eastmann
10-231-00 = Set. 1 + 2
10-231-01 = Fig. 1 = 26 cm / 10¼"
10-231-02 = Fig. 2 = 28 cm / 11"

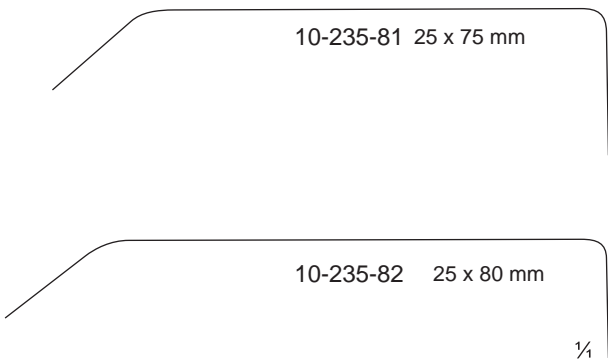
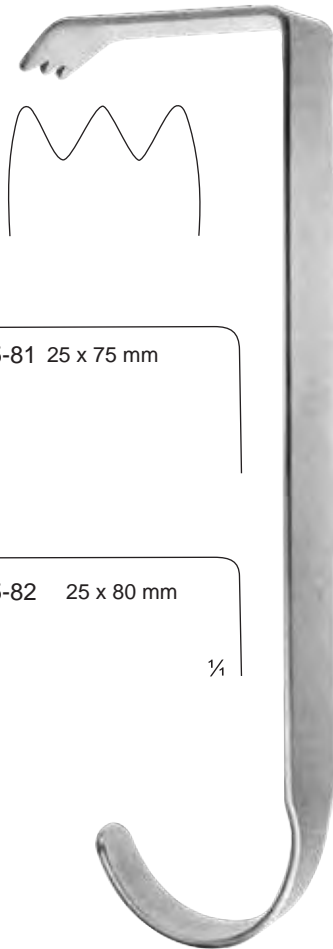
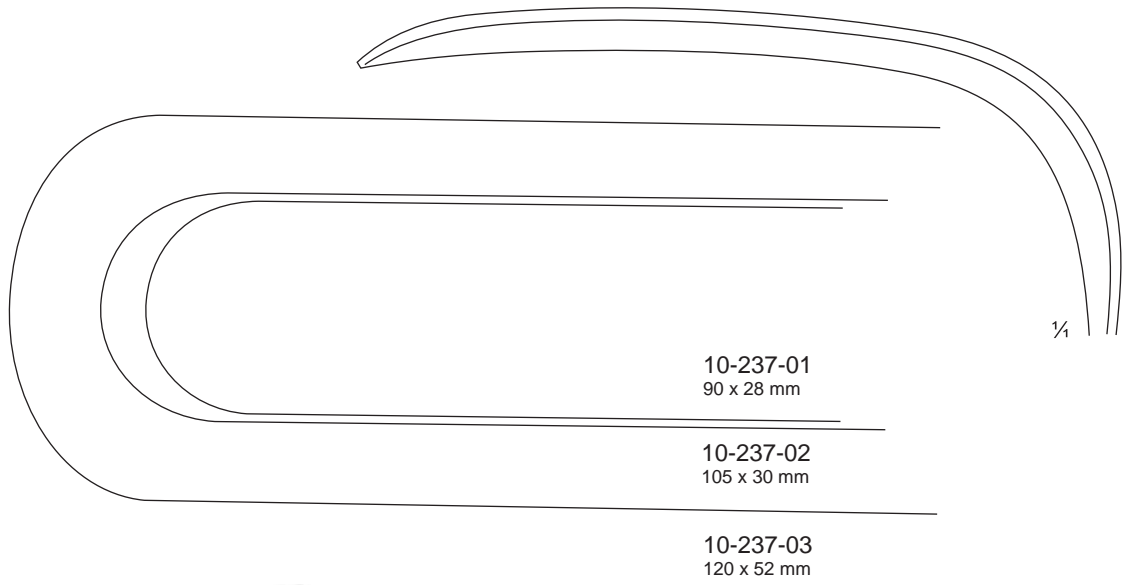
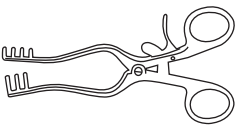

Hibbs
10-235-80
complete set



Doyen Stille
10-237-01 - 10-237-03
26 cm / 10 1/4"

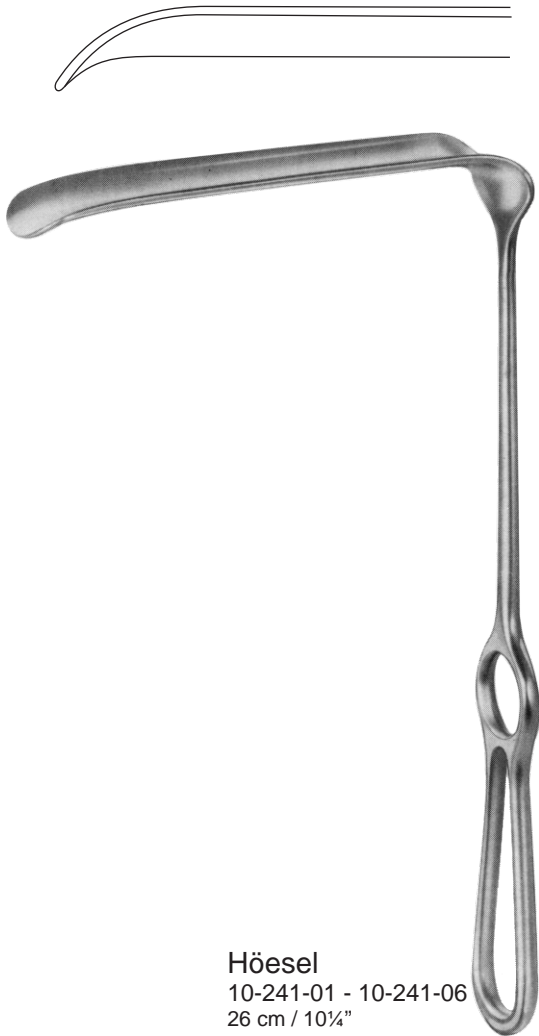
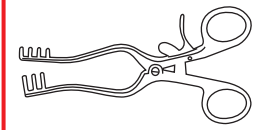

Höesel
 10-241-01 - 10-241-06
 26 cm / 10¼"

10-241-01
 60 x 20 mm

10-241-02
 80 x 30 mm

10-241-03
 100 x 30 mm

10-241-04
 120 x 30 mm

10-241-05
 140 x 30 mm

10-241-06
 140 x 40 mm

¼

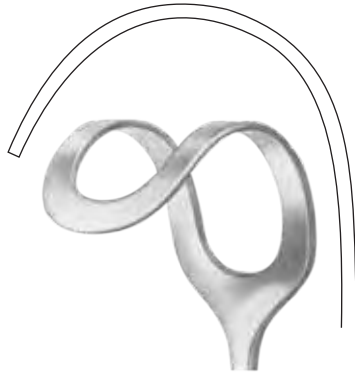
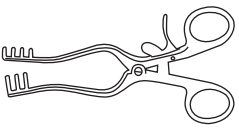

10-245-01
45 x 45 mm

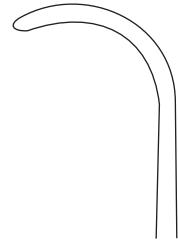

10-248-15
B = 15 mm



$\frac{1}{2}$
Middeldorpf
10-245-01 - 10-245-03
25.5 cm / 10"



10-245-02
45 x 50 mm

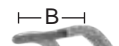

$\frac{1}{4}$
10-248-20
B = 20 mm

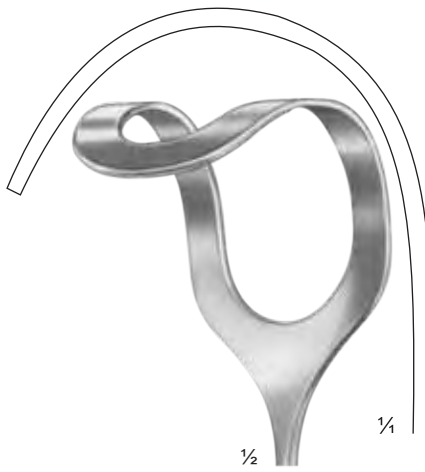

$\frac{1}{2}$
10-245-03
55 x 70 mm

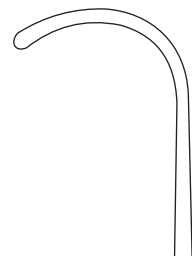

10-248-25
B = 25 mm

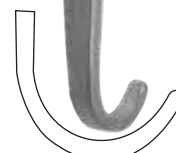

Canny Ryall
10-248-15 - 10-248-25
21.5 cm / 8½"

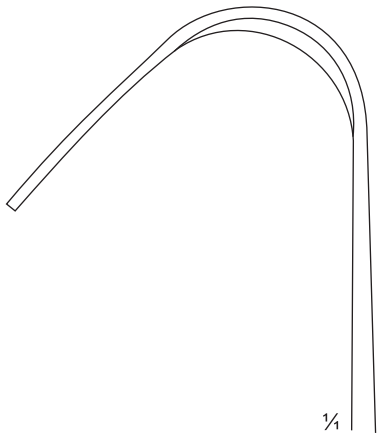
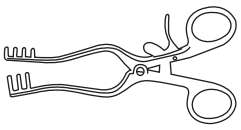

¼

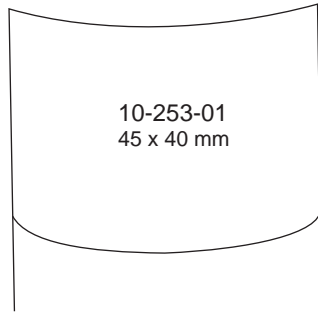

10-253-01
45 x 40 mm

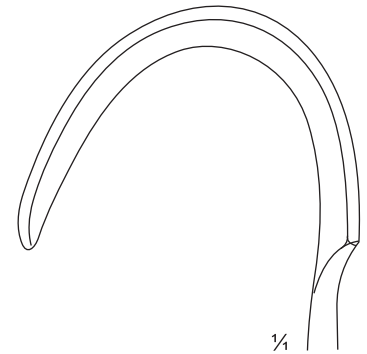

¼



½

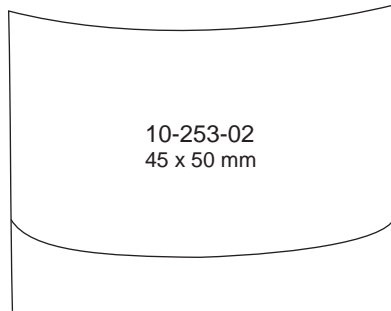

10-253-02
45 x 50 mm

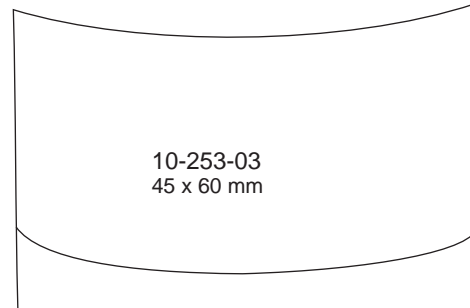

10-253-03
45 x 60 mm

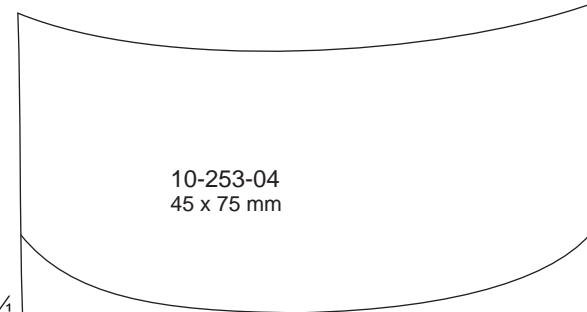

10-253-04
45 x 75 mm

¼



35 X 40 mm

Fritsch
10-255-24
24 cm / 9½"

Fritsch
10-253-01 - 10-253-04
24 cm / 9½"

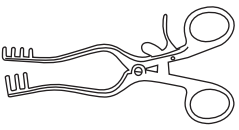

70 X 25 mm

1/2

Kocher
10-259-22
22.5 cm / 9"

1/2

Kocher
10-261-01 - 10-261-03
25.5 cm / 10"

10-261-01 = 80 x 45 mm
10-261-02 = 80 x 55mm
10-261-03 = 80 x 65 mm

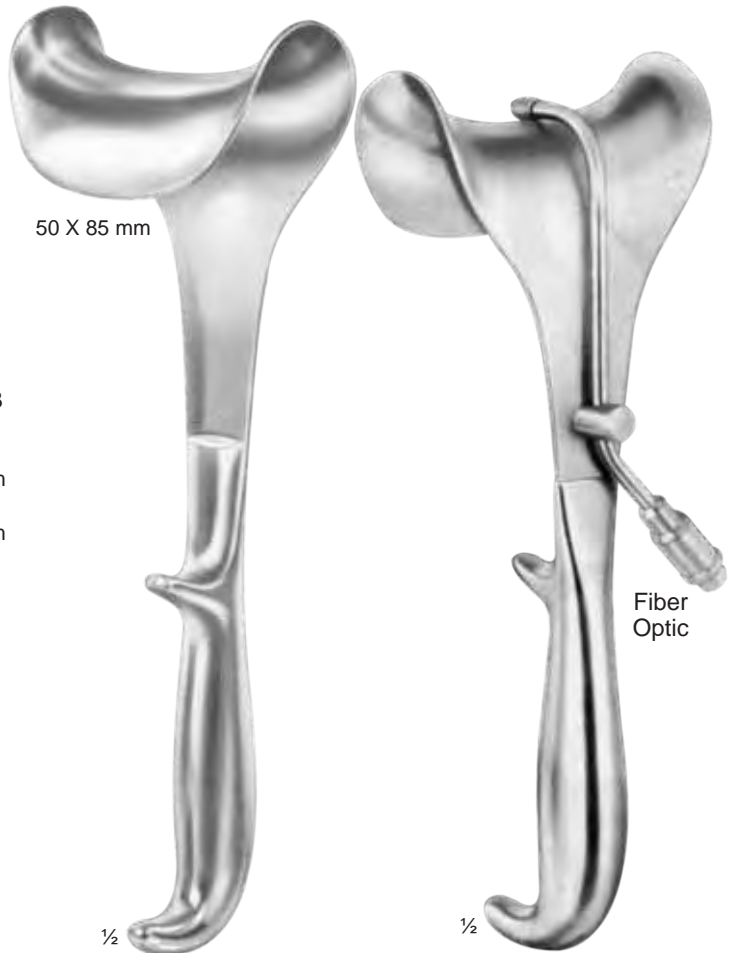

50 X 85 mm

1/2

Doyen
10-263-25
25 cm / 9 3/4"

Fiber
Optic

1/2

Doyen
10-263-75
25 cm / 9 3/4"

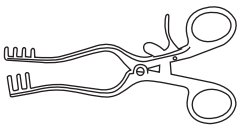

64 X 60 mm

1/2

Tuffier
10-267-23
23 cm / 9"

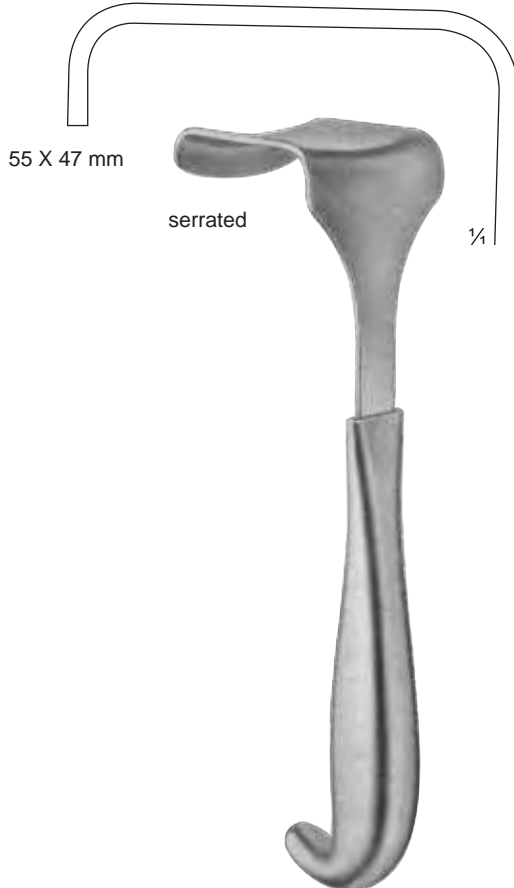

55 X 47 mm

serrated

1/4

Tudor - Edwards
10-270-20
20.5 cm / 8"

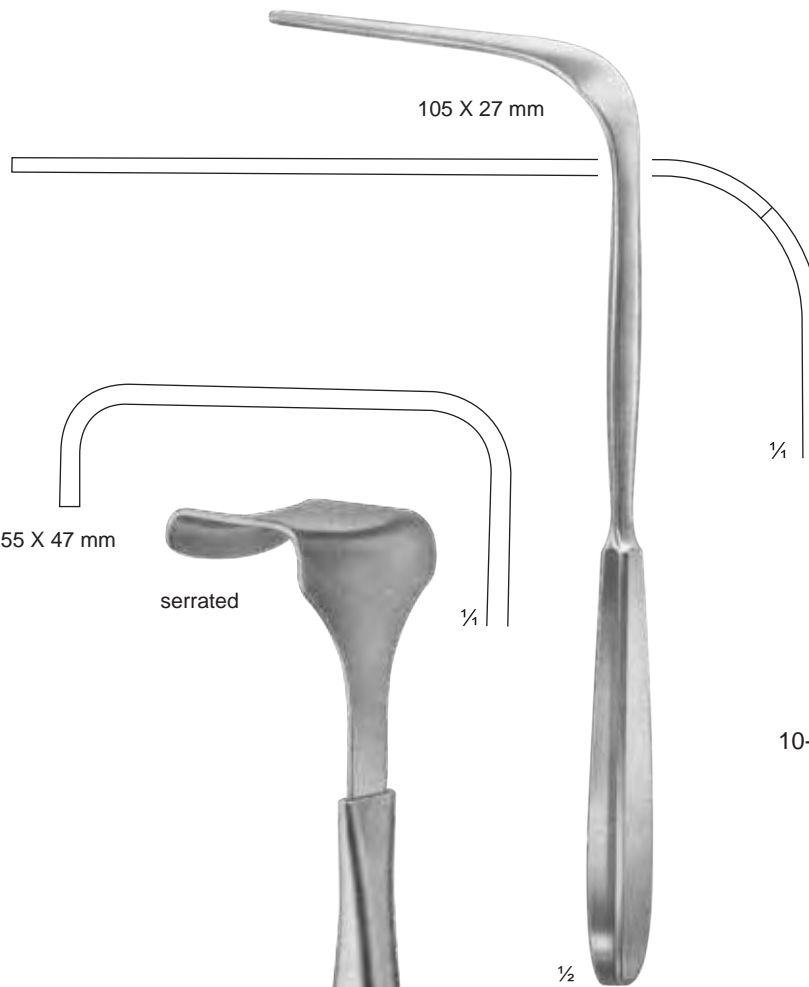

105 X 27 mm

1/2

Martin
10-273-25
26 cm / 10 1/4"

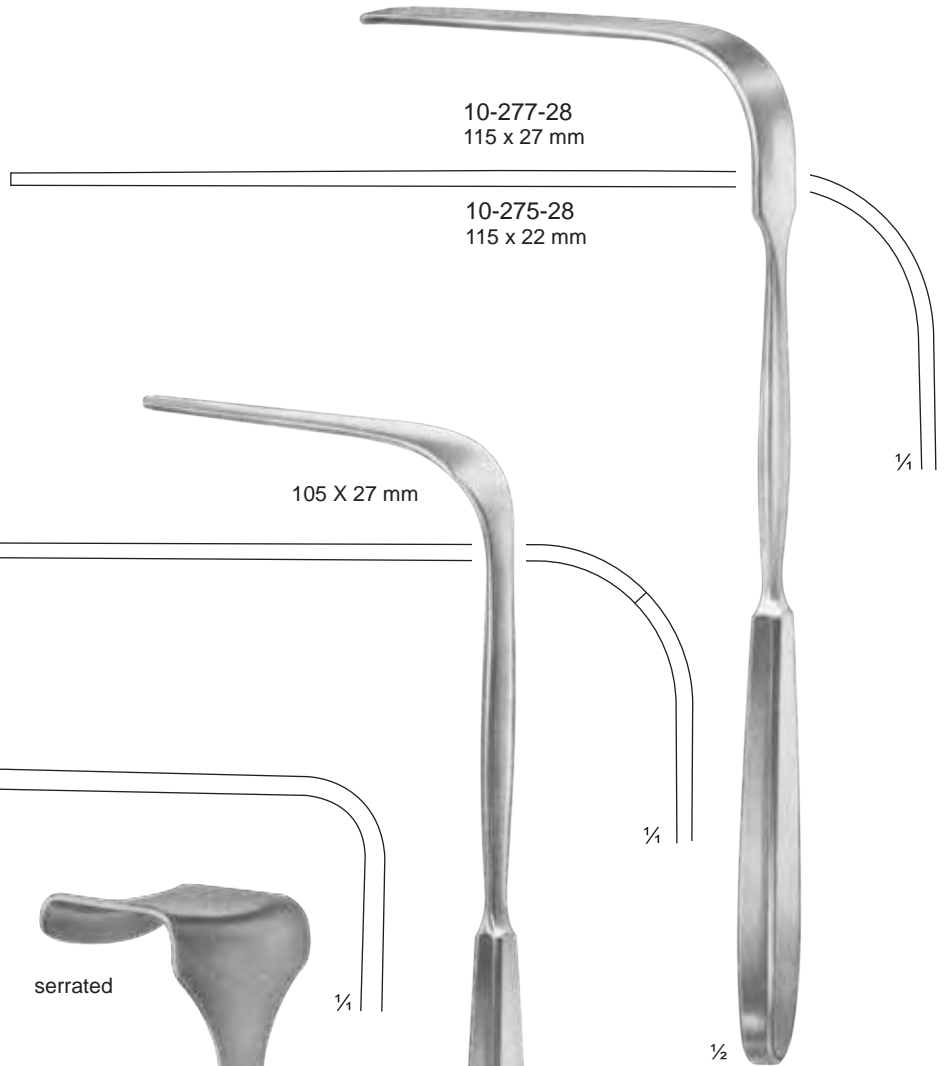

10-277-28
115 x 27 mm

10-275-28
115 x 22 mm

1/4

1/4

1/2

Simon
10-275-28 - 10-277-28
28 cm / 11"

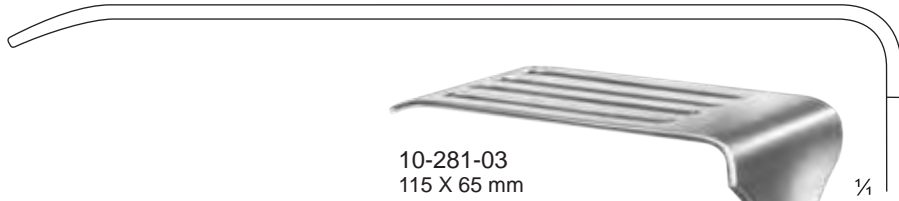
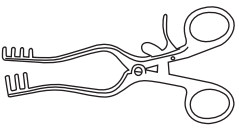

10-281-03
115 X 65 mm

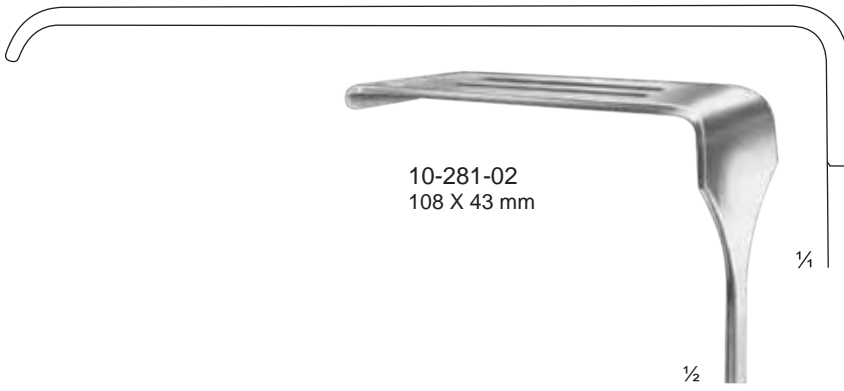

10-281-02
108 X 43 mm

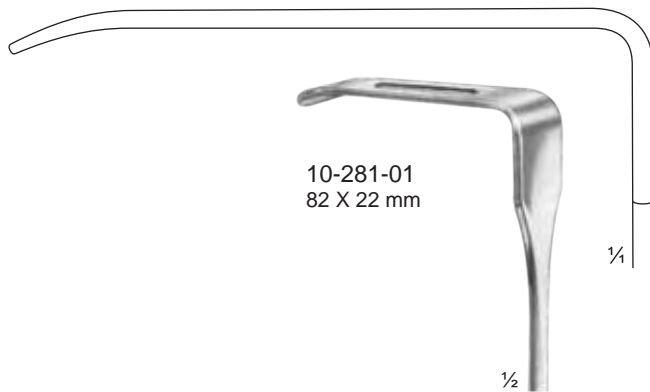

10-281-01
82 X 22 mm

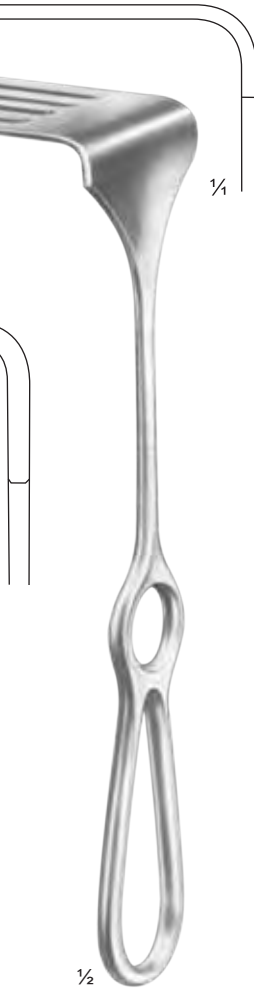

Coryllos
10-281-01 - 10-281-03
24 cm / 9 1/2"

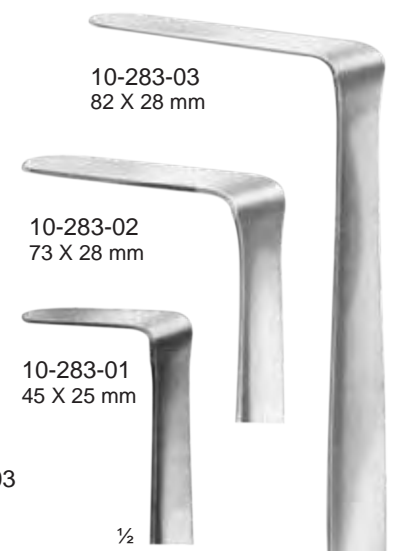

10-283-03
82 X 28 mm

10-283-02
73 X 28 mm

10-283-01
45 X 25 mm

Heaney
10-283-01 - 10-283-03
27 cm / 10 3/4"

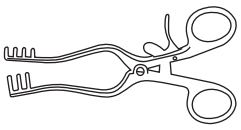

Scapula Retractors

Scapulahaken
Separadores para escápula

Ecarteurs pour scapula
Divaricatori per scapola

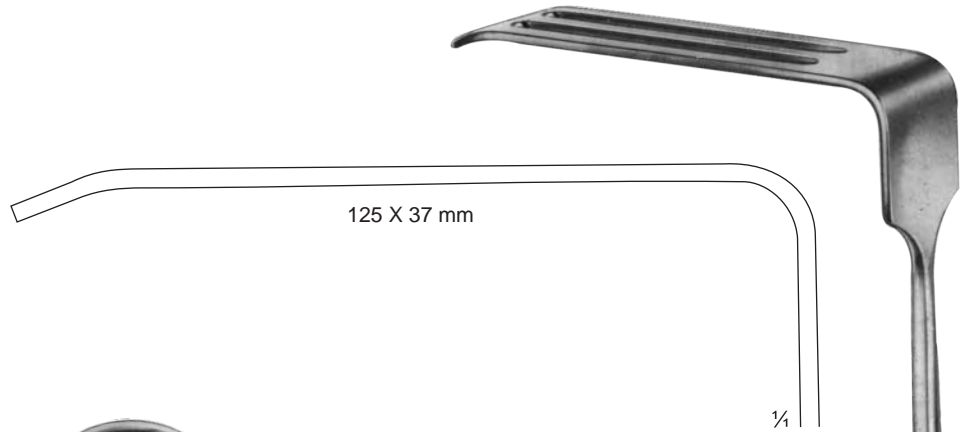

10-287-01
75 X 50 mm
19 cm / 7½"



Sauerbruch
10-289-25
25.5 cm / 10"

½

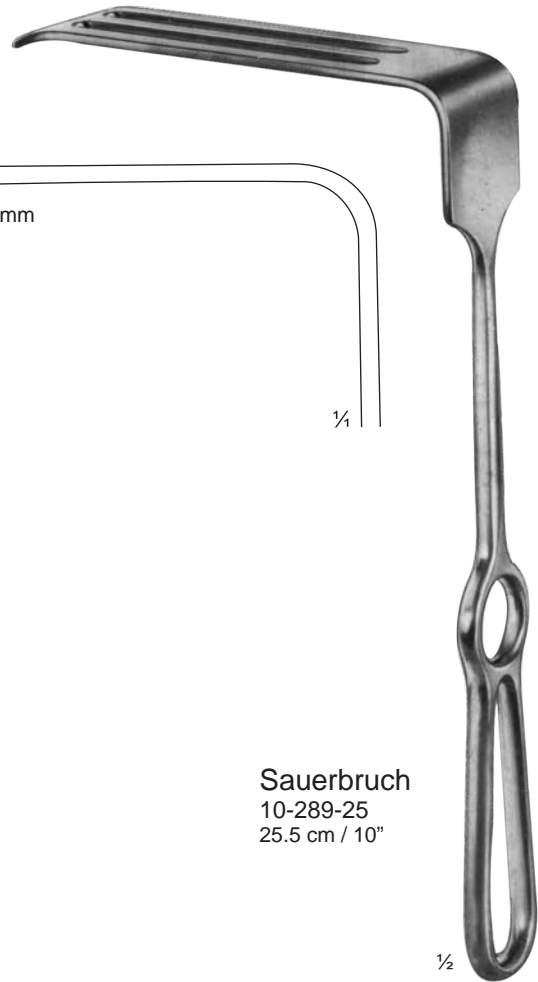

Davidson
10-287-01 - 10-287-02
(Scapula)

Davidson
10-287-02
75 X 90 mm
18.5 cm / 7¼"



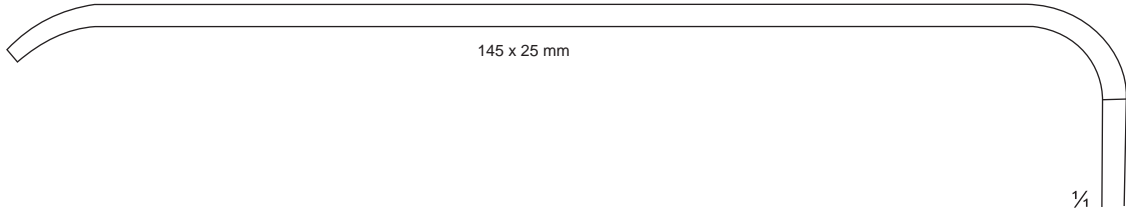
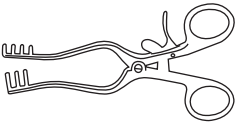

1/2
Brunner
10-293-24
24 cm / 9 1/2"

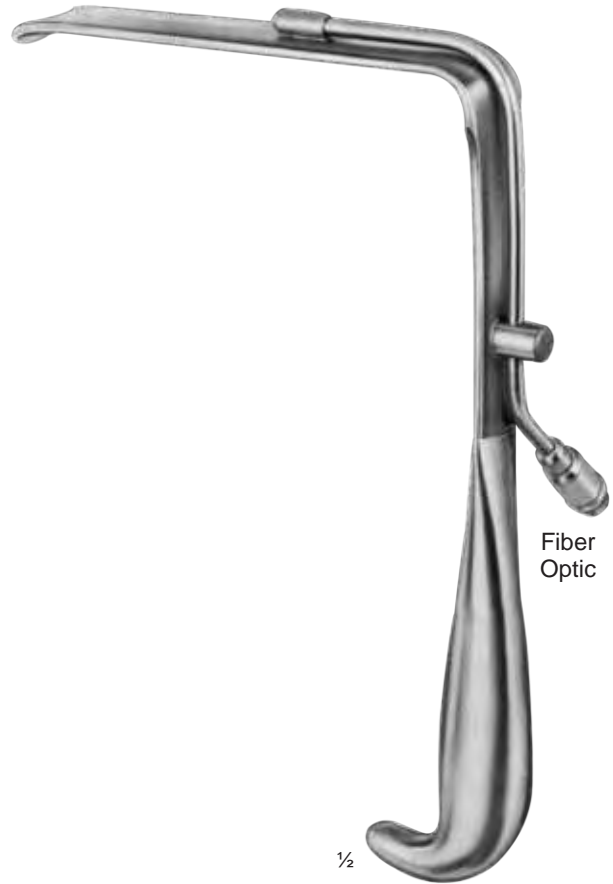

1/2
Brunner
10-293-74
24 cm / 9 1/2"

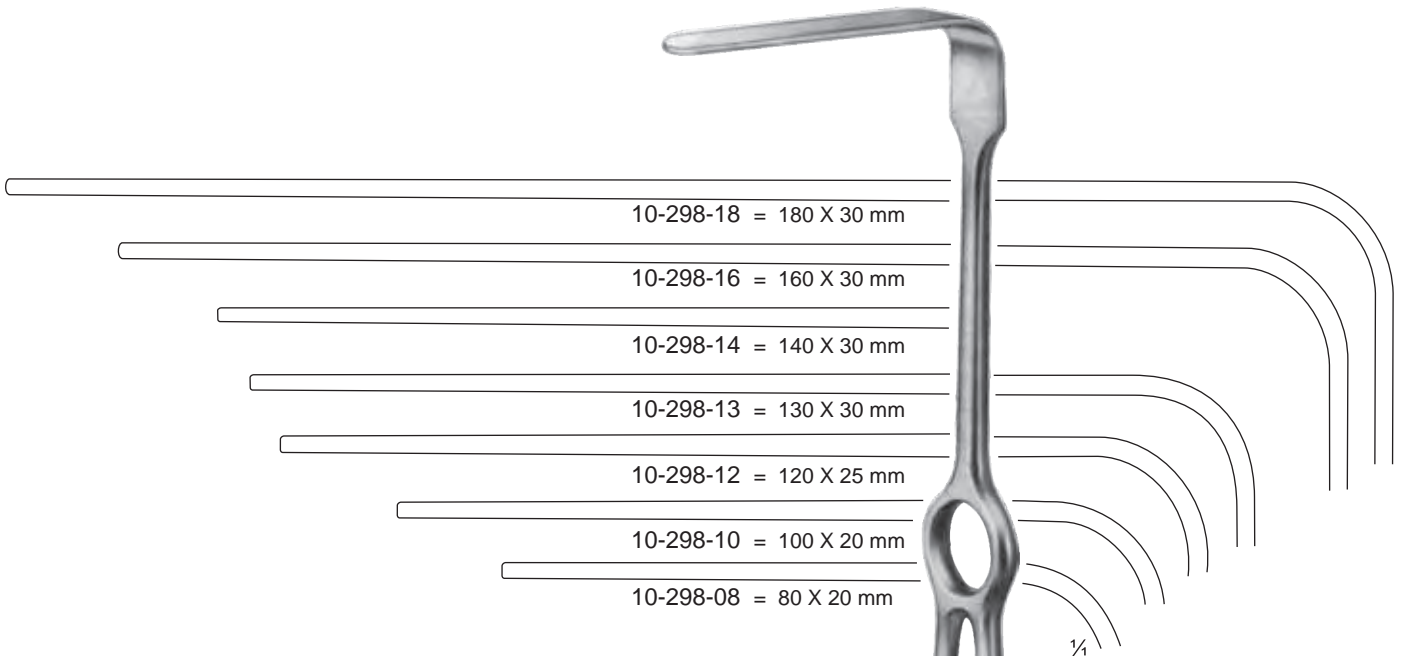
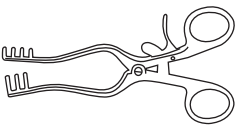

Brunner
 10-298-08 - 10-298-18
 25.5 cm / 10"

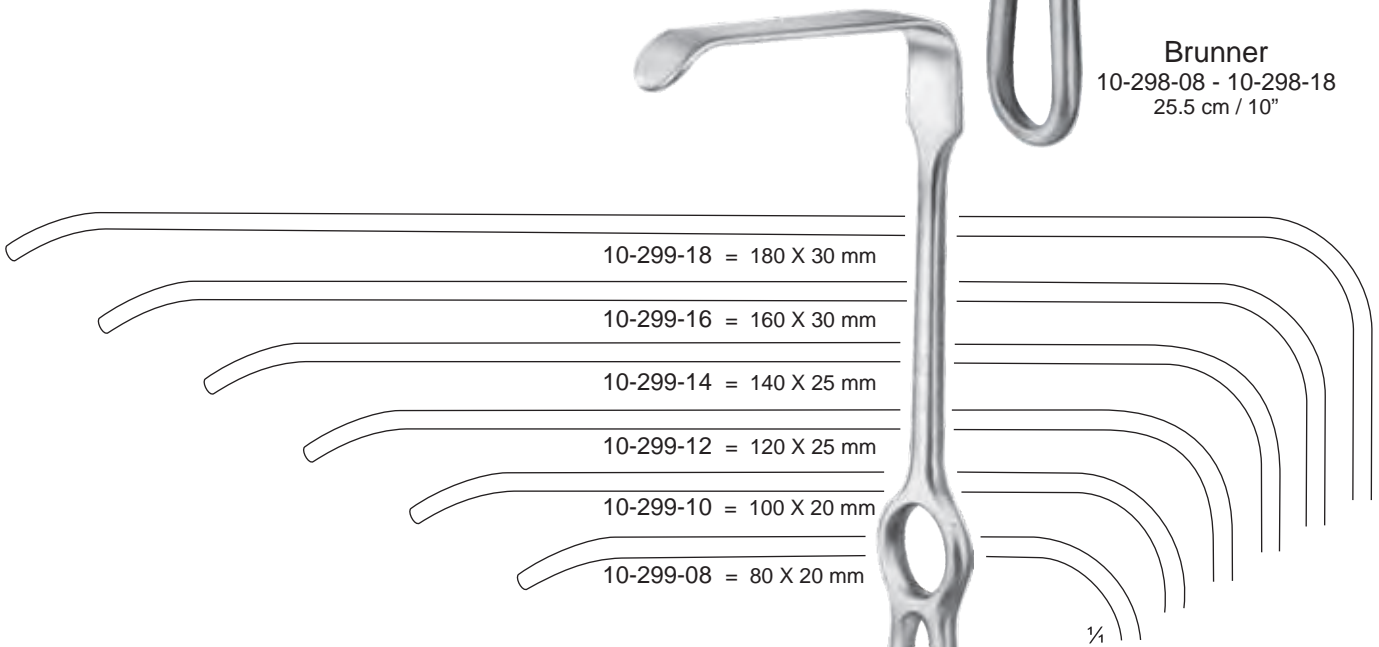

Brunner
 10-299-08 - 10-299-18
 25.5 cm / 10"

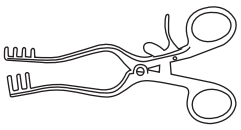

Aorta Retractors

Aortahaken
Separadores para aorta

Ecarteurs pour aorta
Divaricatori per aorta



1/2

Ross
10-303-01 - 10-303-06
27 cm / 10 3/4"
(Aorta)



10-303-01
Fig. 1



10-303-02
Fig. 2



10-303-03
Fig. 3



1/4
10-303-04
Fig. 4



10-303-05
Fig. 5



10-303-06
Fig. 6



1/2

Crawford
10-306-01 - 10-306-02
19 cm / 7 1/2"

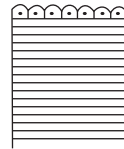

10-306-01
15 x 15 mm

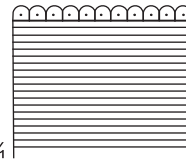

1/4
10-306-02
15 x 23 mm

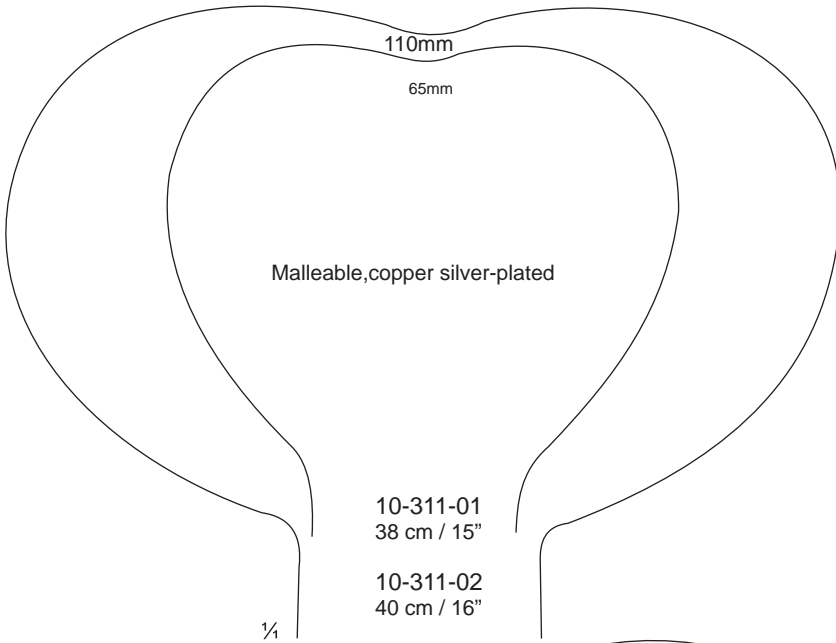
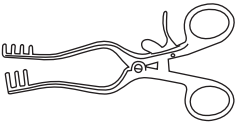

Holmann
10-311-01 - 10-311-02

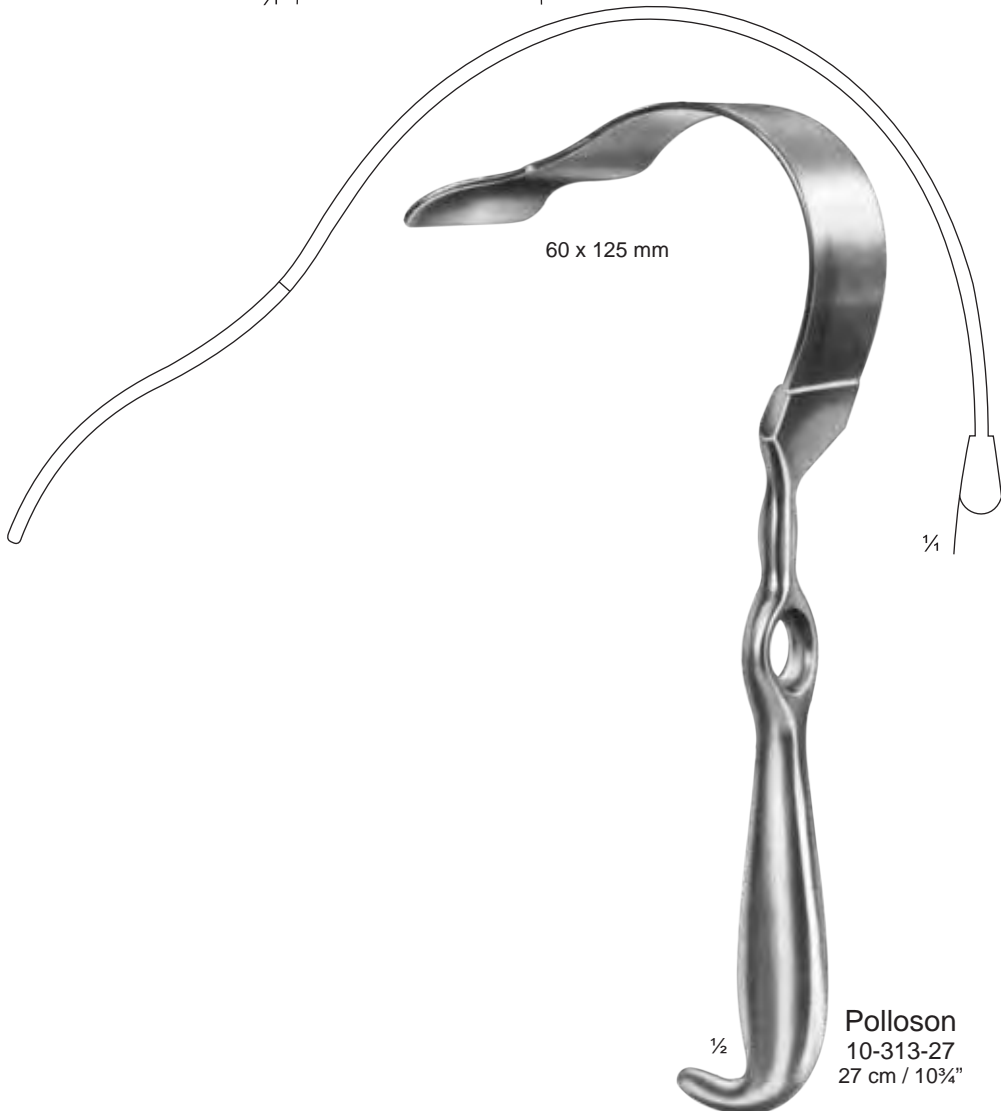

Polloson
10-313-27
27 cm / 10 3/4"

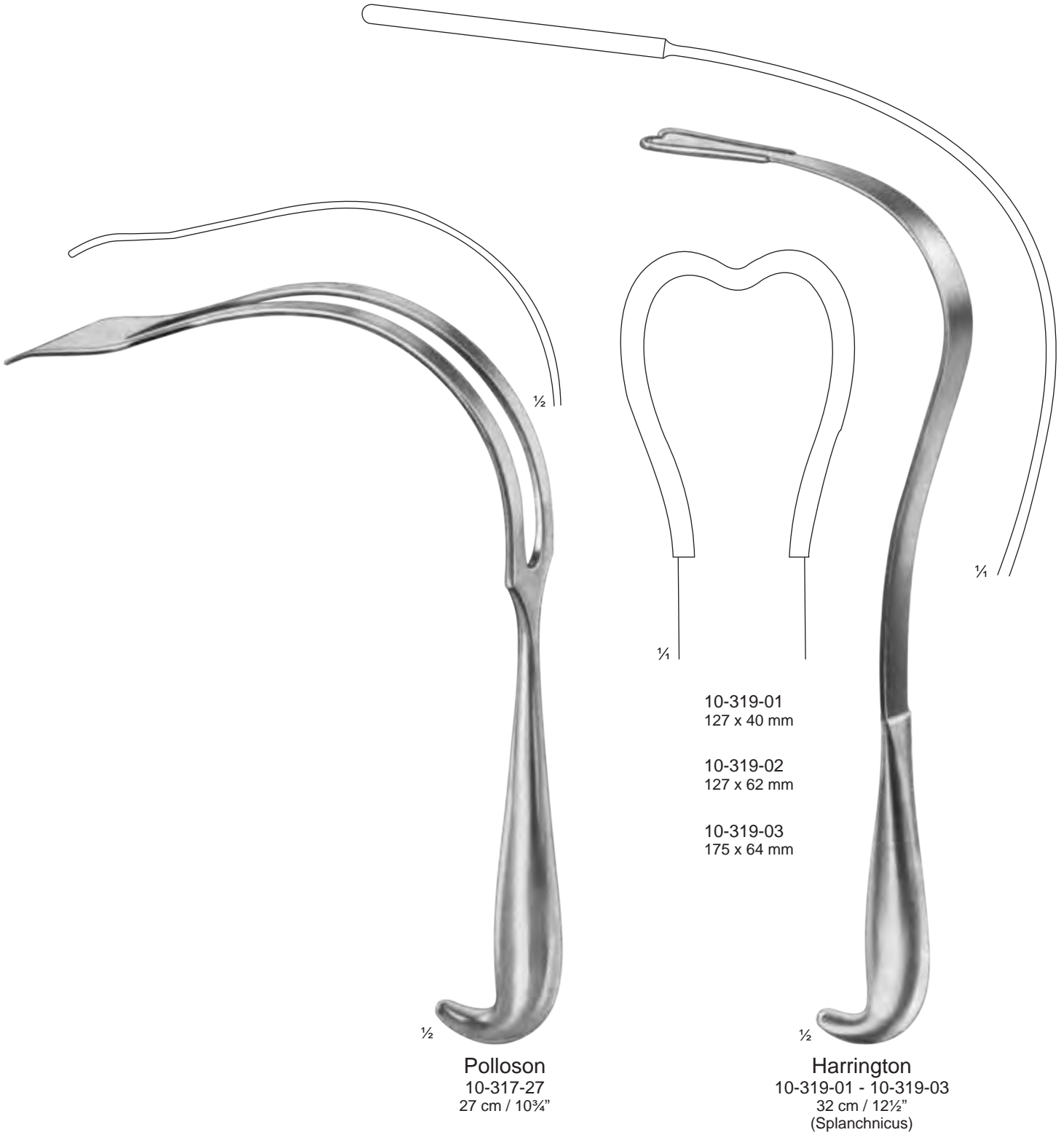
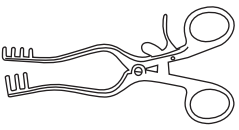

1/2
Polloson
 10-317-27
 27 cm / 10 3/4"

10-319-01
 127 x 40 mm

10-319-02
 127 x 62 mm

10-319-03
 175 x 64 mm

1/2
Harrington
 10-319-01 - 10-319-03
 32 cm / 12 1/2"
 (Splanchnicus)

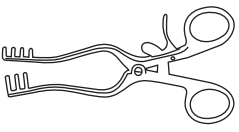

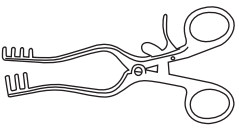

38 mm



½

Deaver
10-327-07
30 cm / 11¾"

50 mm



½

Deaver
10-327-08
31 cm / 12¼"

75 mm



½

Deaver
10-327-09
31.5 cm / 12½"

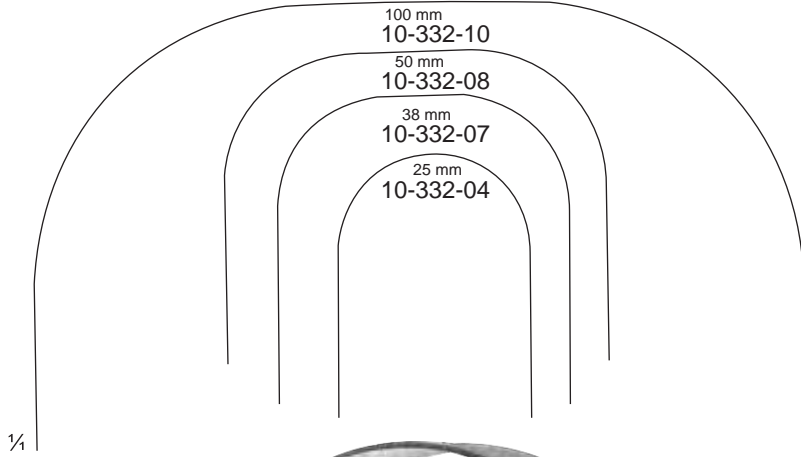
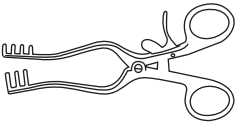

1/2

Deaver
10-332-04 - 10-332-10
31.5 cm / 12½"

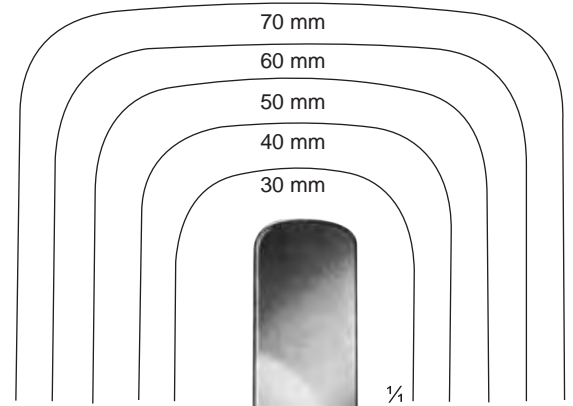

1/4

malleable

- 41 cm / 16¼"
- 245 x 30 mm 10-335-30
- 245 x 40 mm 10-335-40
- 245 x 50 mm 10-335-50
- 245 x 60 mm 10-335-60
- 245 x 70 mm 10-335-70

10-335-30 - 10-335-70

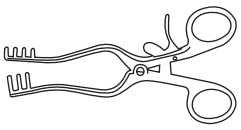

Atrium Retractors

Atriumhaken
Separadores para atrio

Ecarteurs pour atrium
Divaricatori per atrio



Cooley
10-339-01
21.5 cm / 8 1/2"
(Atrium)



Cooley
10-339-02
21.5 cm / 8 1/2"
(Atrium)



Cooley
10-339-03
23 cm / 9"
(Atrium)

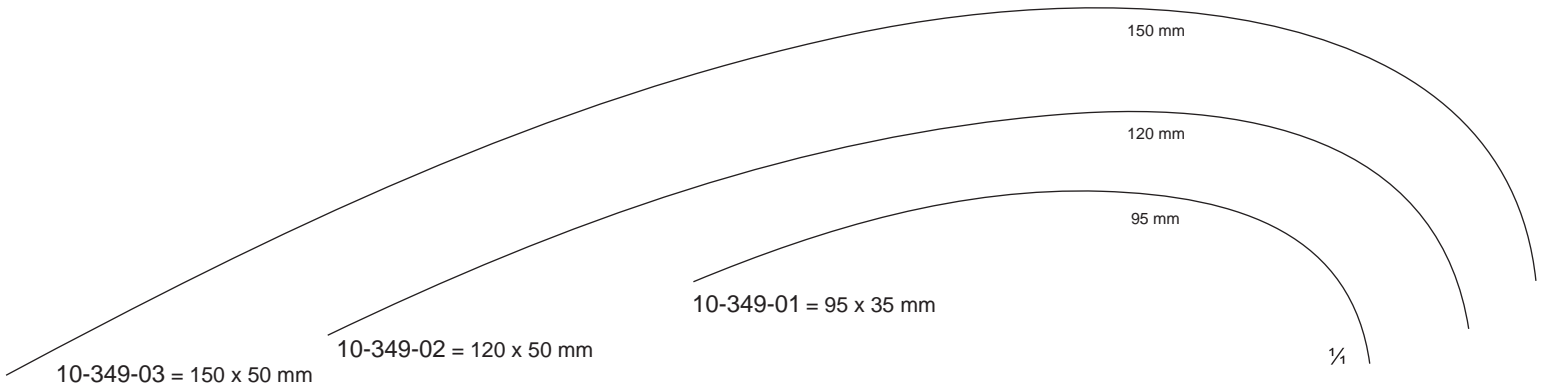
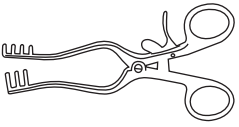

- 90 x 15 mm 10-346-15
- 90 x 20 mm 10-346-20
- 90 x 30 mm 10-346-30
- 110 x 35 mm 10-346-35
- 110 x 40 mm 10-346-40
- 120 x 55 mm 10-346-55

Doyen-Stillie
10-346-15 - 10-346-55
24 cm / 9½"



Mikulicz
10-349-01 - 10-349-03
26 cm / 10¼"

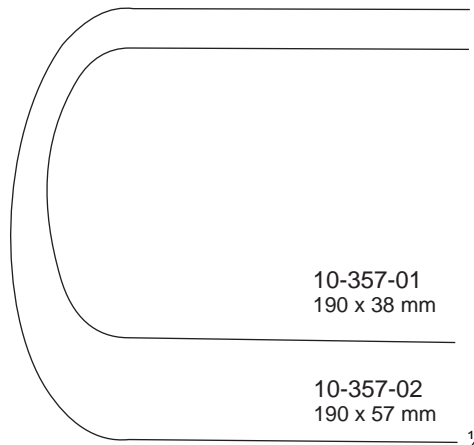
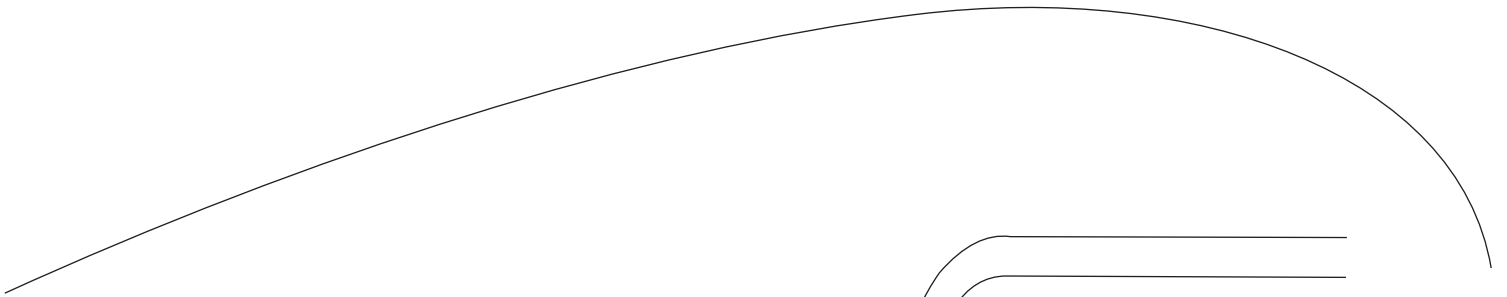
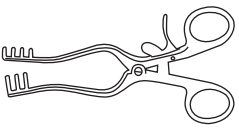

10-357-01
190 x 38 mm

10-357-02
190 x 57 mm

1/4

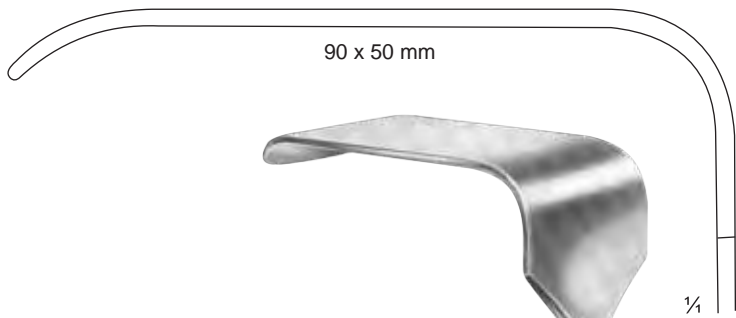

90 x 50 mm

1/4



Mikulicz
10-355-26
26 cm / 10 1/4"

1/2



Kelly
10-357-01 - 10-357-02
27 cm / 10 3/4"

1/2

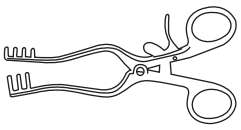

Pelvis Retractors

Beckenhaken
Separadores para pelvis

Ecarteurs pour pelvis
Divaricatori per pelvis

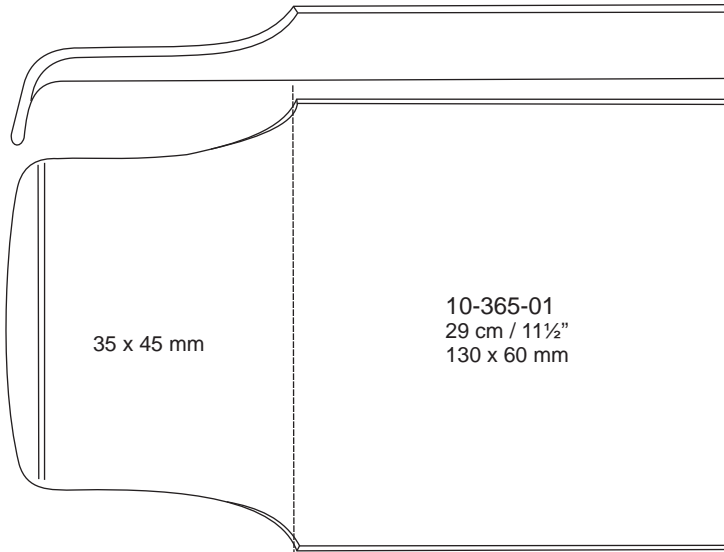

35 x 45 mm

10-365-01
29 cm / 11½"
130 x 60 mm

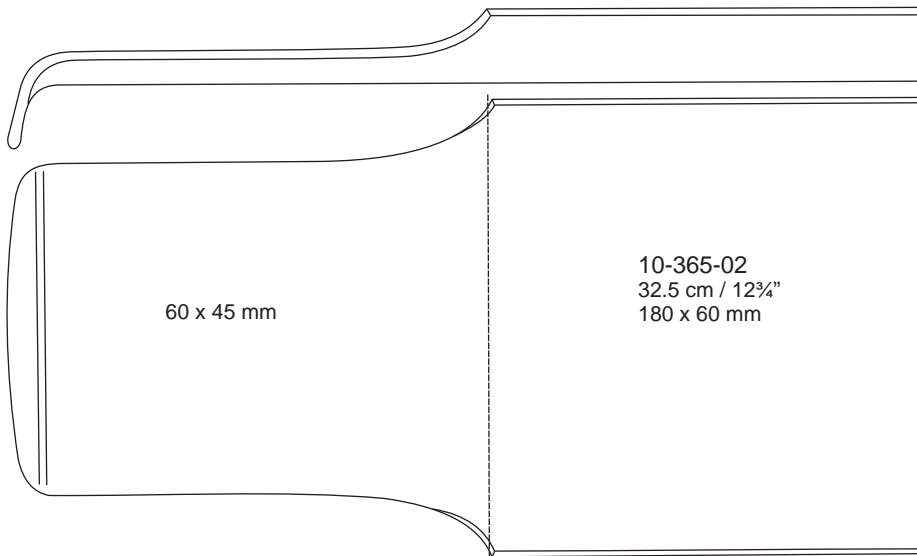

60 x 45 mm

10-365-02
32.5 cm / 12¾"
180 x 60 mm

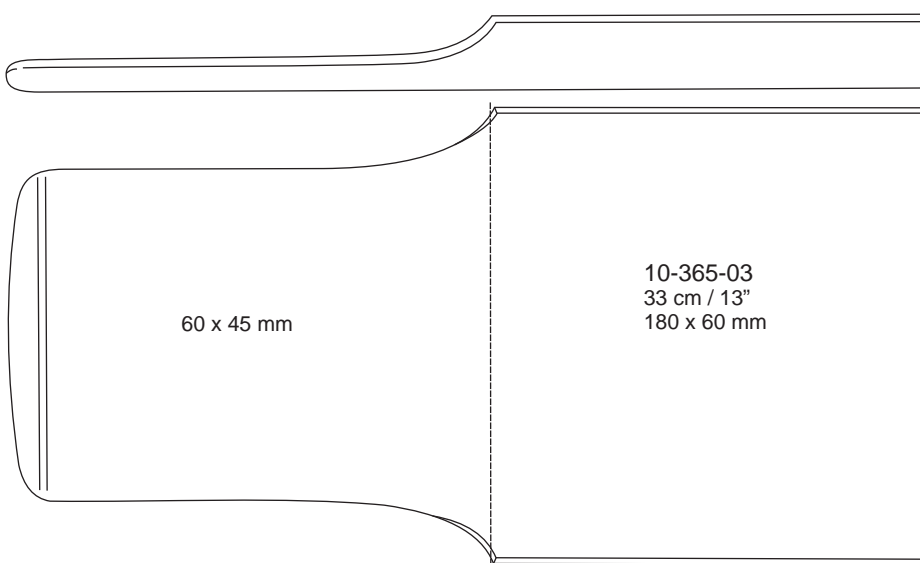

60 x 45 mm

10-365-03
33 cm / 13"
180 x 60 mm



St.Marks/Lloyd Davies
10-365-01 - 10-365-03
pelvis retractor

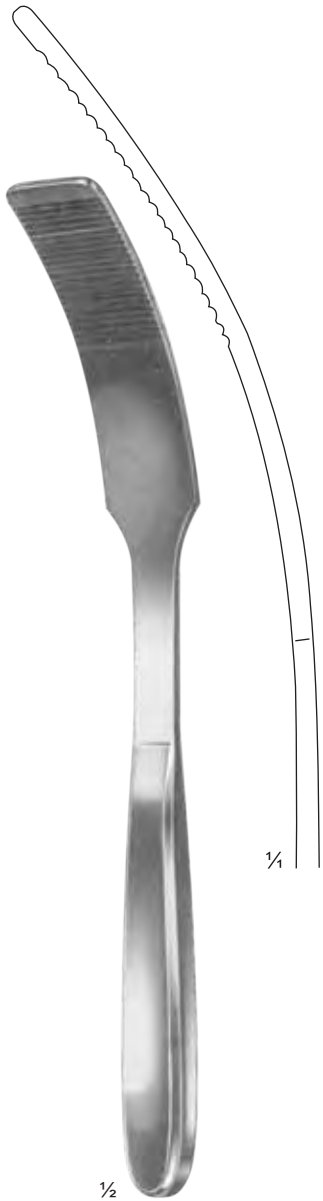
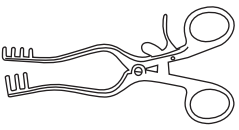

Kader

27 cm / 10 3/4"
 10-371-20 = 20 mm
 10-371-30 = 30 mm
 10-371-40 = 40 mm

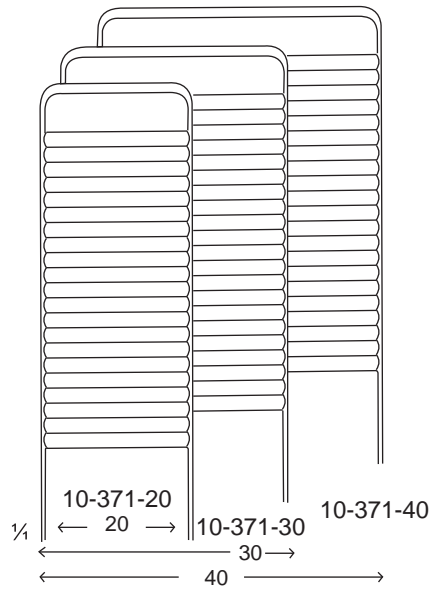

Koerte

10-373-28
 28 cm / 11"
 rigid



Kummel

10-375-28
 28 cm / 11"

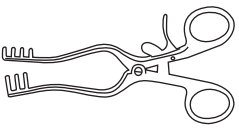

16 x 10 mm
16 x 17 mm
16 x 23 mm

10-382-10
10-382-17
10-382-23

Durham
10-382-10 - 10-382-23
22.5 cm / 9"

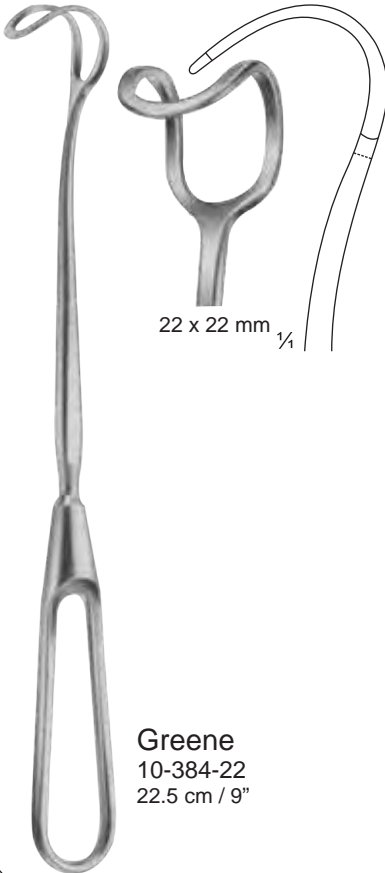

22 x 22 mm $\frac{1}{4}$

Greene
10-384-22
22.5 cm / 9"



$\frac{1}{4}$
38 x 18 mm

Büechs
10-386-20
20.5 cm / 8"



40 x 25 mm

$\frac{1}{4}$

Ollier
10-388-22
22 cm / 8 $\frac{3}{4}$ "



28 x 6 mm

$\frac{1}{4}$

$\frac{1}{2}$

Lahey
10-390-19
19 cm / 7 $\frac{1}{2}$ "



$\frac{1}{4}$
12 x 14 mm

$\frac{1}{2}$

Little
10-393-20
20 cm / 8"



90 x 25 mm

Landon
10-396-19
19 cm / 7 $\frac{1}{2}$ "

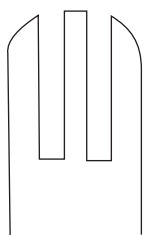
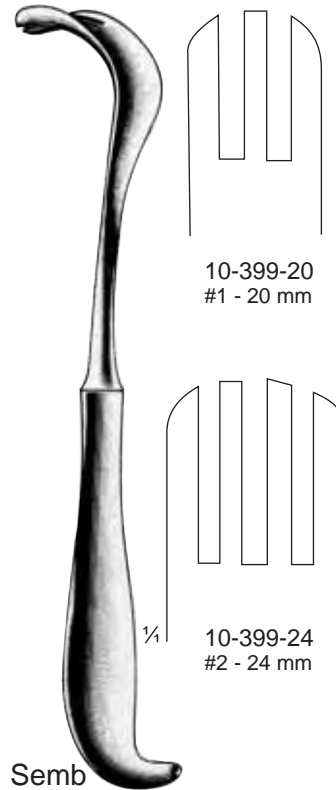

10-399-20
#1 - 20 mm

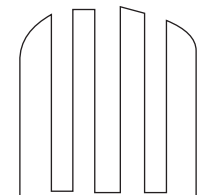

$\frac{1}{4}$
10-399-24
#2 - 24 mm

Semb
10-399-20
10-399-24
25 cm / 9 $\frac{3}{4}$ "

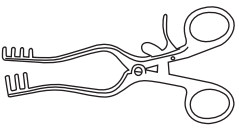

10-403-22 = 6 x 22 mm
 10-403-44 = 13 x 44 mm
 10-403-64 = 25 x 64 mm

Langenbeck
 10-403-22 - 10-403-64
 21 cm / 8¼"



22 x 12 mm

Lempert
 10-406-23
 23 cm / 9"

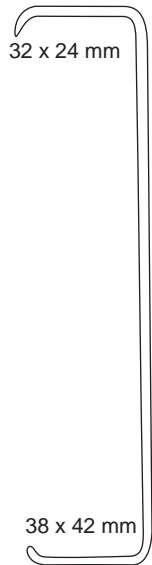

32 x 24 mm

38 x 42 mm



Mathieu
 10-409-17
 17.8 cm / 7"

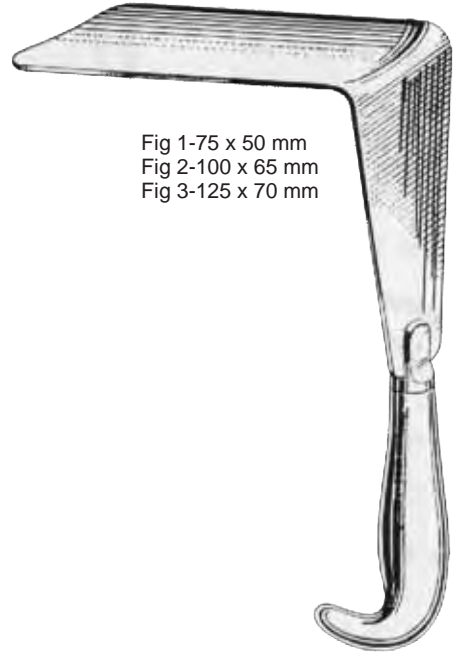
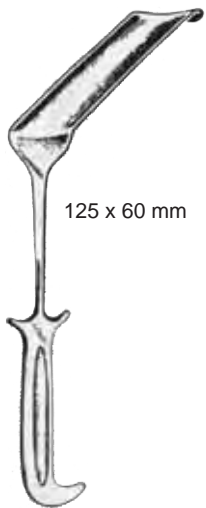

Fig 1-75 x 50 mm
 Fig 2-100 x 65 mm
 Fig 3-125 x 70 mm

Pyrah
 Fig1 = 10-412-01
 Fig2 = 10-412-02
 Fig3 = 10-412-03
 25 cm / 9¾"



125 x 60 mm

Nuttle
 10-415-00
 29 cm / 11½"



100 x 50 mm

Worrall
 10-418-00
 25 cm / 9¾"



95 x 38 mm

Wertheim
 10-420-00
 30 cm / 11¾"
 (Vaginal)



50 x 20 mm

Jackson Burrow
 10-422-01
 22.5 cm / 8¾"
 (Knee Joint)



50 x 14 mm

Jackson Burrow
 10-422-02
 22.5 cm / 8¾"
 (Knee Joint)

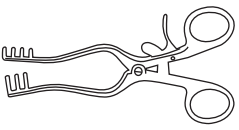

Hajek
10-428-16
16.5 cm / 6½"

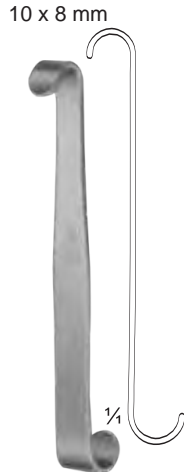

10 x 8 mm
Luer
10-430-11
12 x 11 mm
11.5 cm / 4½"

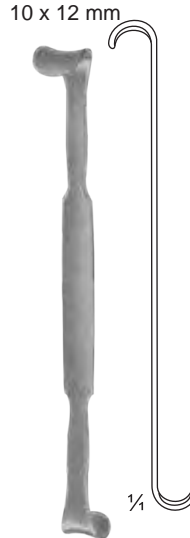

10 x 12 mm
Rose
10-433-13
11 x 15 mm
13 cm / 5"

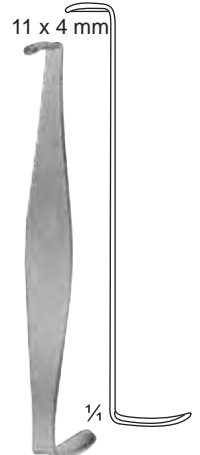

11 x 4 mm
Rose
10-436-11
19 x 6 mm
11.5 cm / 4½"



26 x 15 mm
22 x 15 mm
US-Army
10-439-22
39 x 15 mm
43 x 15 mm
22 cm / 8¾"

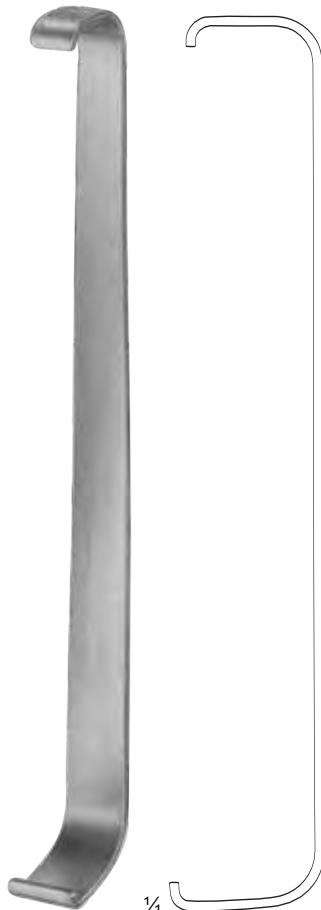

Lane
10-441-23
23 cm / 9"

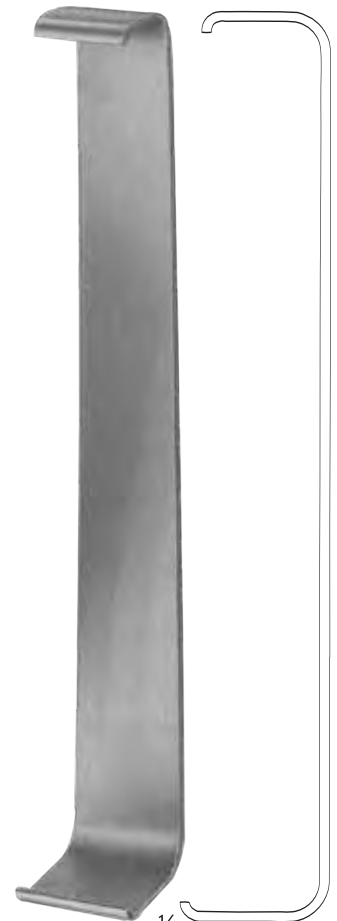

Lane
10-444-23
23 cm / 9"

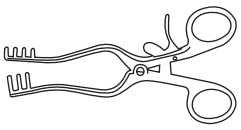

Collin-Hartmann

10-451-01 = 14 cm / 5½"
10-451-02 = 16 cm / 6¼"

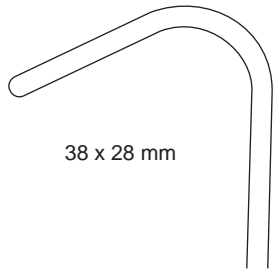

38 x 28 mm

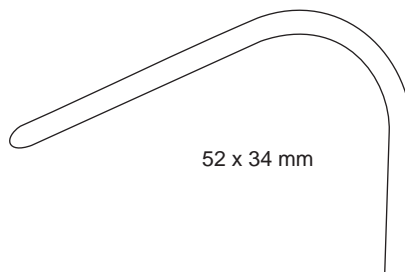

52 x 34 mm

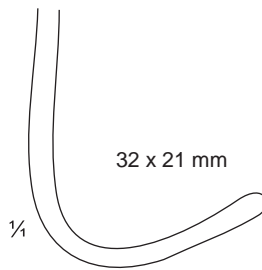

32 x 21 mm

¼

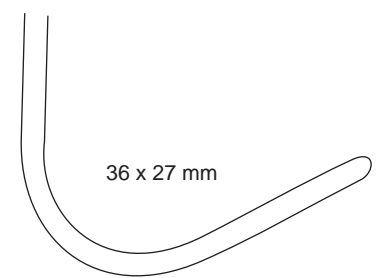

36 x 27 mm



½

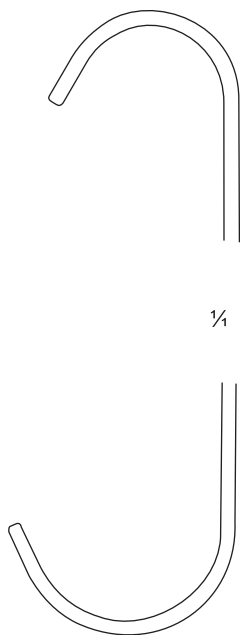

¼

Baby-Roux

10-453-13
13 cm / 5"



¼

Roux

10-455-00 = set. Fig. 1-3
10-455-01 = Fig. 1 = 14 cm / 5½"
10-455-02 = Fig.2 = 15 cm / 6"
10-455-03 = Fig.3 = 17 cm / 6¾"
10-455-04 = Fig.4 = 18 cm / 7"

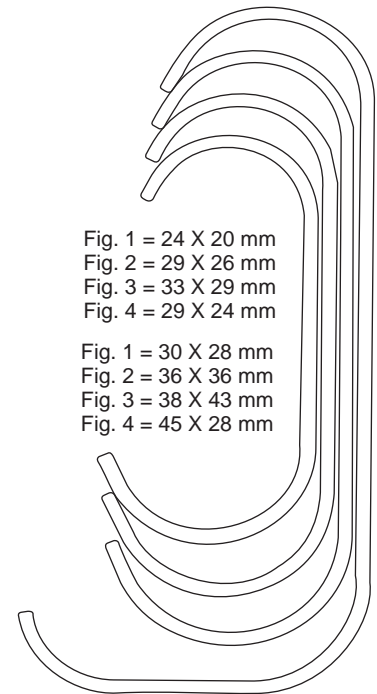
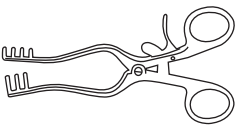

Fig. 1 = 24 X 20 mm
Fig. 2 = 29 X 26 mm
Fig. 3 = 33 X 29 mm
Fig. 4 = 29 X 24 mm

Fig. 1 = 30 X 28 mm
Fig. 2 = 36 X 36 mm
Fig. 3 = 38 X 43 mm
Fig. 4 = 45 X 28 mm



1/2

Farabeuf
10-461-00 = set
12 cm / 4 3/4"

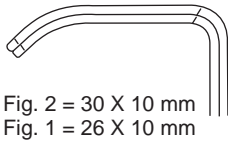

Fig. 2 = 30 X 10 mm
Fig. 1 = 26 X 10 mm

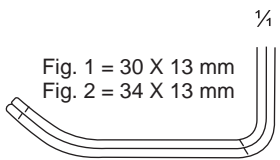
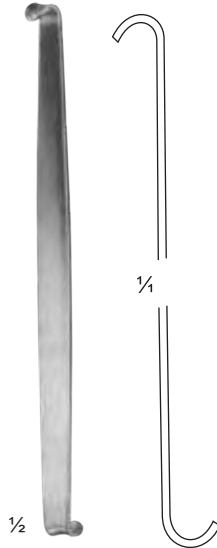

Fig. 1 = 30 X 13 mm
Fig. 2 = 34 X 13 mm

1/4



1/2

Mini-Roux
10-463-06
12 cm / 4 3/4"

1/4



1/2

Farabeuf
10-465-00 = set
15 cm / 6"

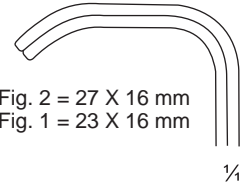

Fig. 2 = 27 X 16 mm
Fig. 1 = 23 X 16 mm

1/4

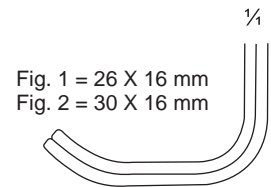

Fig. 1 = 26 X 16 mm
Fig. 2 = 30 X 16 mm

1/4



1/2

Parker
10-467-01 Set
13.5 cm / 5 1/4"

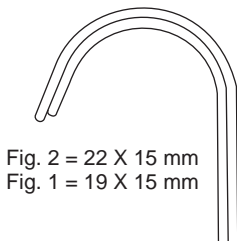

Fig. 2 = 22 X 15 mm
Fig. 1 = 19 X 15 mm

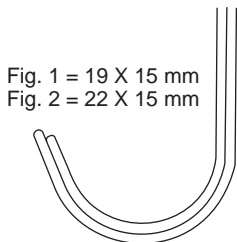

Fig. 1 = 19 X 15 mm
Fig. 2 = 22 X 15 mm



1/2

Parker-Mott
10-469-00 = Set
16 cm / 6 1/4"

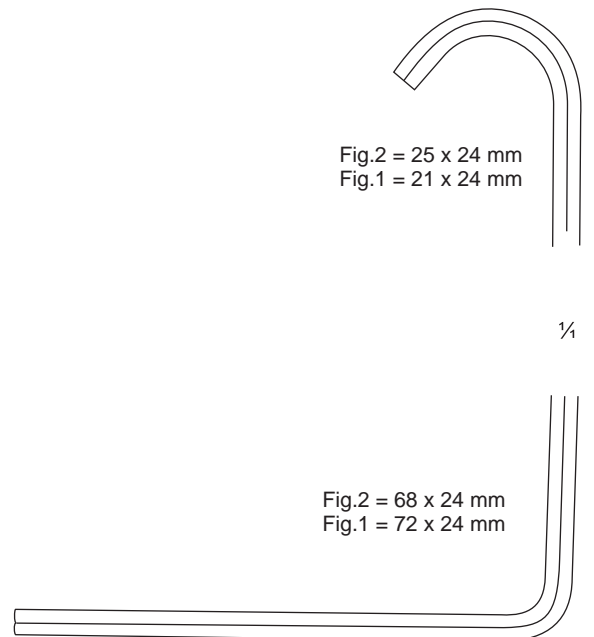

Fig.2 = 25 x 24 mm
Fig.1 = 21 x 24 mm

1/4

Fig.2 = 68 x 24 mm
Fig.1 = 72 x 24 mm

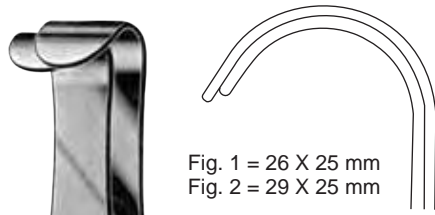
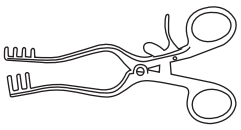

Fig. 2 = 27 X 25 mm
Fig. 1 = 24 X 25 mm

Parker

10-475-02 = Set
18 cm / 7"

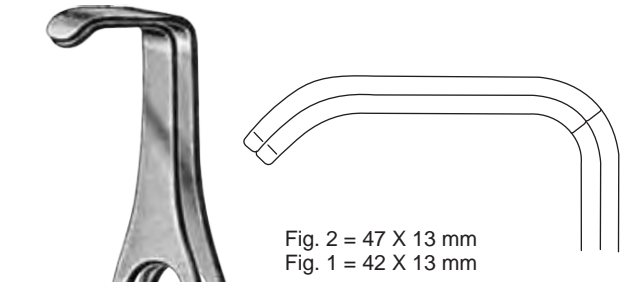

Fig. 1 = 42 X 26 mm
Fig. 2 = 46 X 26 mm

Mathieu

10-477-00 = Set
20 cm / 8"

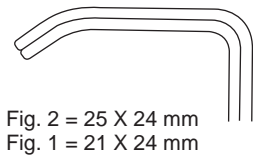
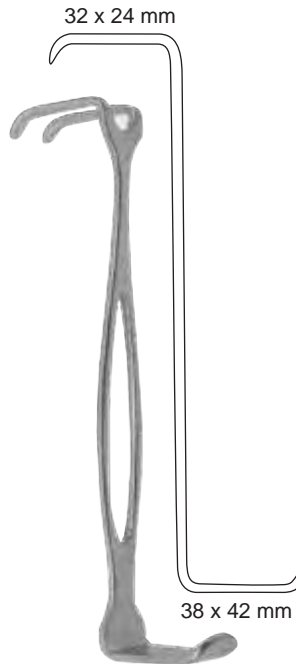

Fig. 2 = 25 X 24 mm
Fig. 1 = 21 X 24 mm

Fig. 1 = 40 X 15 mm
Fig. 2 = 45 X 15 mm

Parker-Langenbeck

10-479-00 = set
21 cm / 8 1/4"



Czerny

10-482-17
17.5 cm / 7"



Goelet

10-485-00
19 cm / 7 1/2"

30 X 30 mm

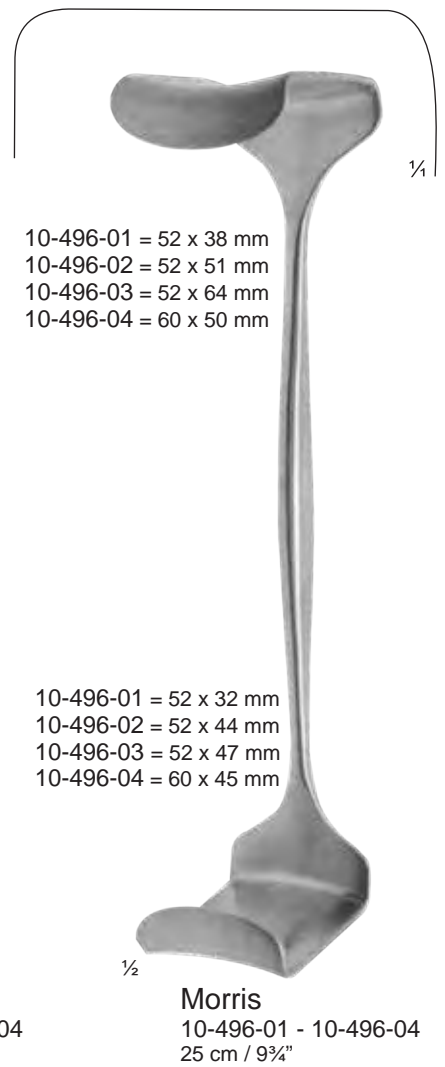
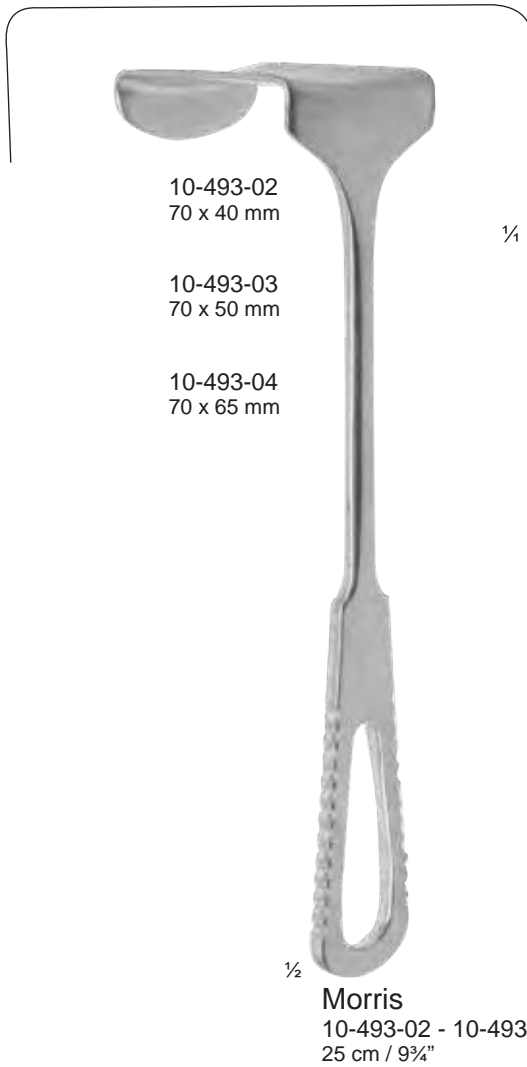
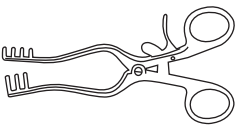

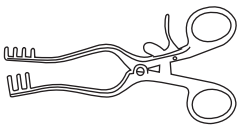

Self-Retaining Retractors

Selbsthaltende Wundsperrer
Separadores autoestaticos

Ecarteurs autostatiques
Divaricatori autostatici



Finsen
10-500-05-10-503-07
5 cm / 2"

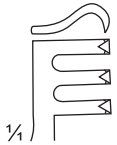

10-500-05
5 cm / 2"
sharp
2 x 3 teeth

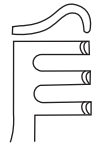

10-501-05
5 cm / 2"
blunt
2 x 3 teeth

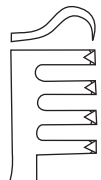

10-502-07
7 cm / 2 3/4"
sharp
3 x 4 teeth

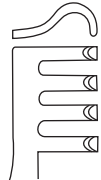

10-503-07
7 cm / 2 3/4"
blunt
3 x 4 teeth



Finsen-Mod. Martin
10-506-07 - 10-507-07
7 cm / 2 3/4"
3 x 4 teeth

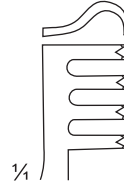

10-506-07
sharp

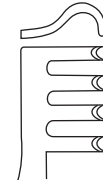

10-507-07
blunt

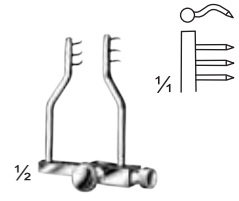

Logan
10-510-04
4 cm / 1 1/2"
3 x 3 teeth

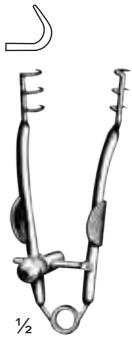

Buckley
10-512-06
6 cm / 2 1/4"
sharp
3 x 3 teeth



10-514-08
8 cm / 3 1/4"
3 x 3 teeth



Alm
10-517-07 - 10-519-10
4 x 4 teeth

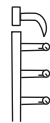

10-517-07
7 cm / 2 3/4"
sharp



10-518-07
7 cm / 2 3/4"
blunt

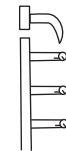

10-517-10
10 cm / 4"
sharp



10-518-10
10 cm / 4"
blunt

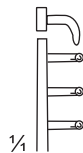

10-519-10
10 cm / 4"
semi-sharp



10-521-10
10 cm / 4"
blunt
4 x 4 teeth

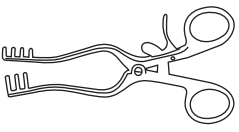

Self-Retaining Retractors

Selbsthaltende Wundsperrer
Separadores autoestaticos

Ecarteurs autostatiques
Divaricatori autostatici

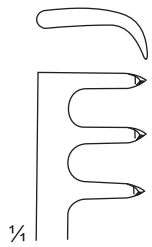

10-530-10
sharp

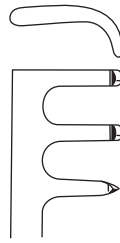

10-531-10

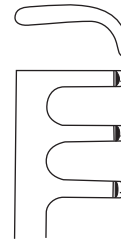

10-533-10
blunt

with one sharp
and 2 blunt prongs.
each.



Snitman
10-526-10 = 10.5 cm / 4¼"
Sharp
10-527-10 = 10.5 cm / 4¼"
Blunt
3 x 3 teeth



Jansen
10-530-10 - 10-533-10
10 cm / 4"
3 x 3 teeth



Jansen
10-536-10 = 10 cm / 4"
Sharp
10-537-10 = 10 cm / 4"
Blunt
4 x 4 teeth

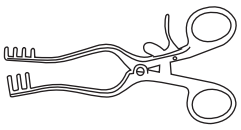

Self-Retaining Retractors

Selbsthaltende Wundsperrer
Separadores autoestaticos

Ecarteurs autostatiques
Divaricatori autostatici

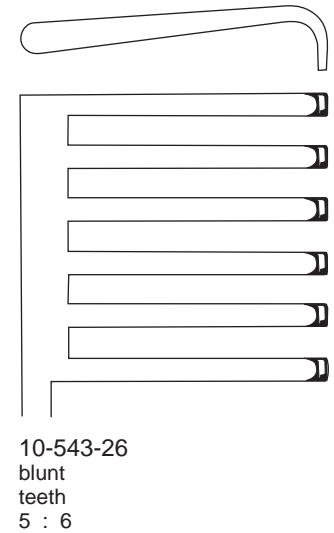
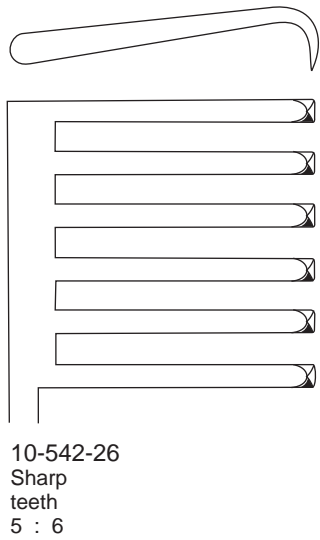
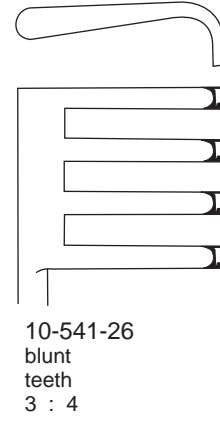
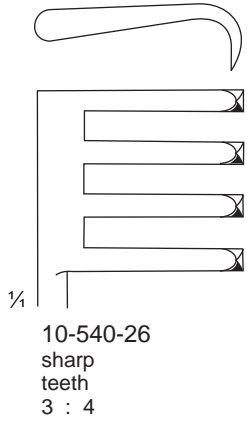

Adson
10-540-26 - 10-543-26
26.5 cm / 10 1/2"

Self-Retaining Retractors

Selbsthaltende Wundsperrer
Separadores autoestaticos

Ecarteurs autostatiques
Divaricatori autostatici

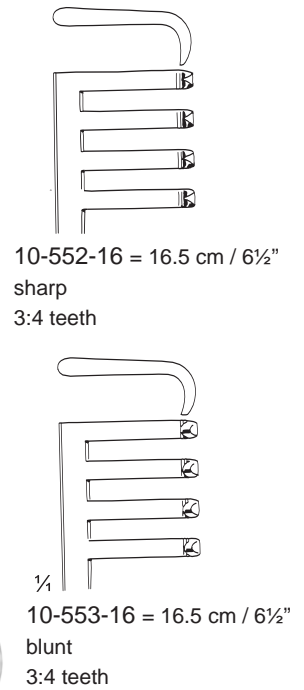
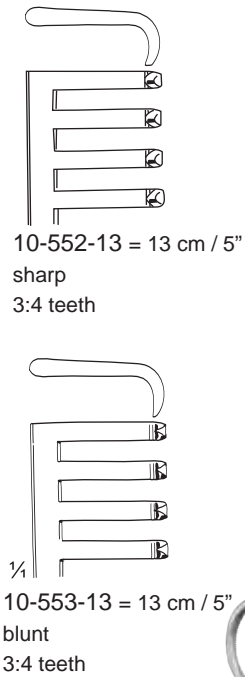
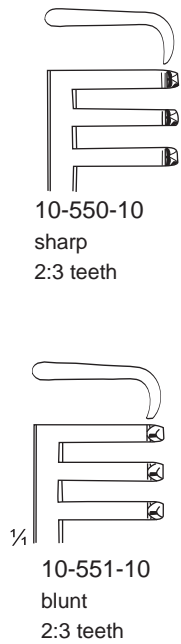
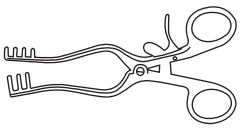

Weitlaner
10-552-13 - 10-553-16

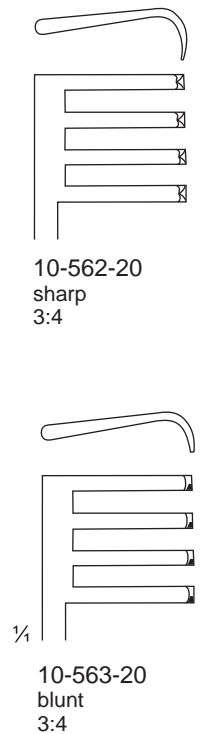
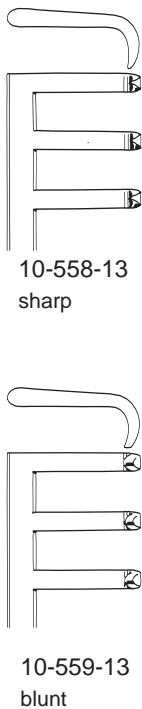

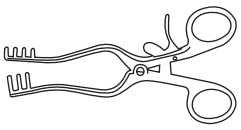

Self-Retaining Retractors

Selbsthaltende Wundsperrer
Separadores autoestaticos

Ecarteurs autostatiques
Divaricatori autostatici



10-568-24 Weitlaner sharp 3 x 4 prongs blunt
24 cm / 9½"



10-569-26 Weitlaner sharp 5 x 6 prongs blunt
24 cm / 9½"

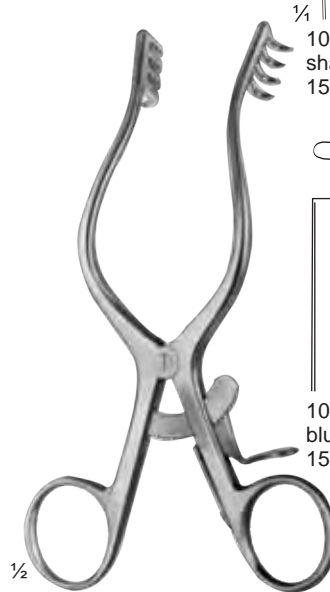

Mollison
10-570-15 - 10-571-18

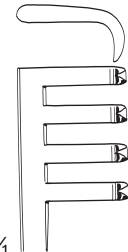

¼
10-570-15
sharp
15 cm / 6"

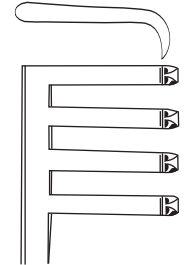

10-570-18
sharp
18 cm / 7"

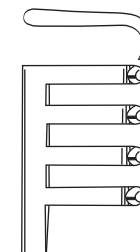

10-571-15
blunt
15 cm / 6"

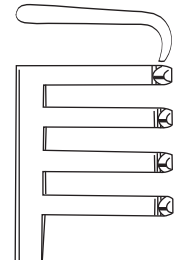

10-571-18
blunt
18 cm / 7"



with central Blades
10-572-19 - 10-572-32

Henley
10-572-01 - 10-572-32
16.5 cm / 6½"

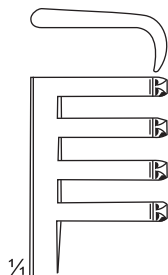

¼
10-572-01
sharp

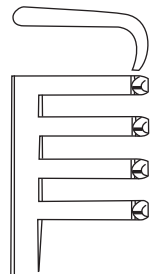

10-572-02
blunt

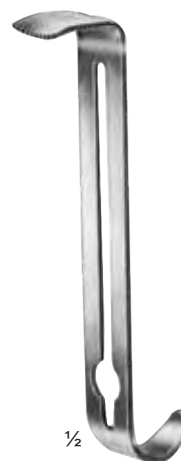

10-572-19
16 mm x 19 mm
5/8 x ¾"



10-572-25
16 mm x 25 mm
5/8 x 1"

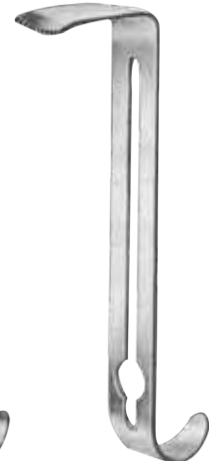

10-572-32
16 mm x 32 mm
5/8 x 1¼"

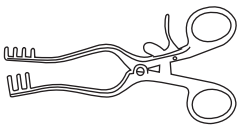

Self-Retaining Retractors

Selbsthaltende Wundsperrer
Separadores autoestaticos

Ecarteurs autostatiques
Divaricatori autostatici

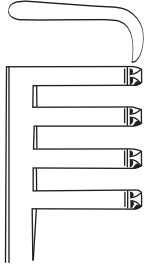

10-578-13
13 cm / 5"

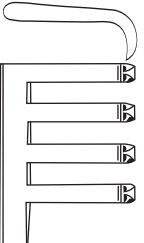

10-578-16
16 cm / 6 1/4"

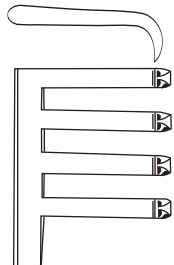

10-578-20
20 cm / 8"

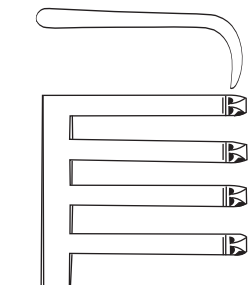

10-578-26
26 cm / 10 1/4"
sharp

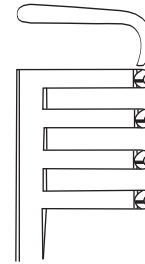

10-579-13
13 cm / 5"

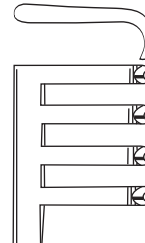

10-579-16
16 cm / 6 1/4"

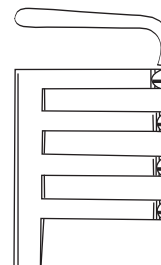

10-579-20
20 cm / 8"

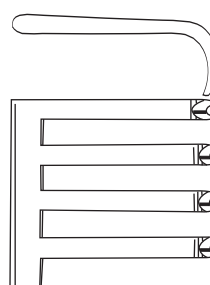

10-579-26
26 cm / 10 1/4"
blunt



Adson
10-578-13 - 10-579-26
3:4 teeth

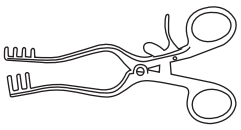

Self-Retaining Retractors

Selbsthaltende Wundsperrer
Separadores autoestaticos

Ecarteurs autostatiques
Divaricatori autostatici

Exchangeable Blades

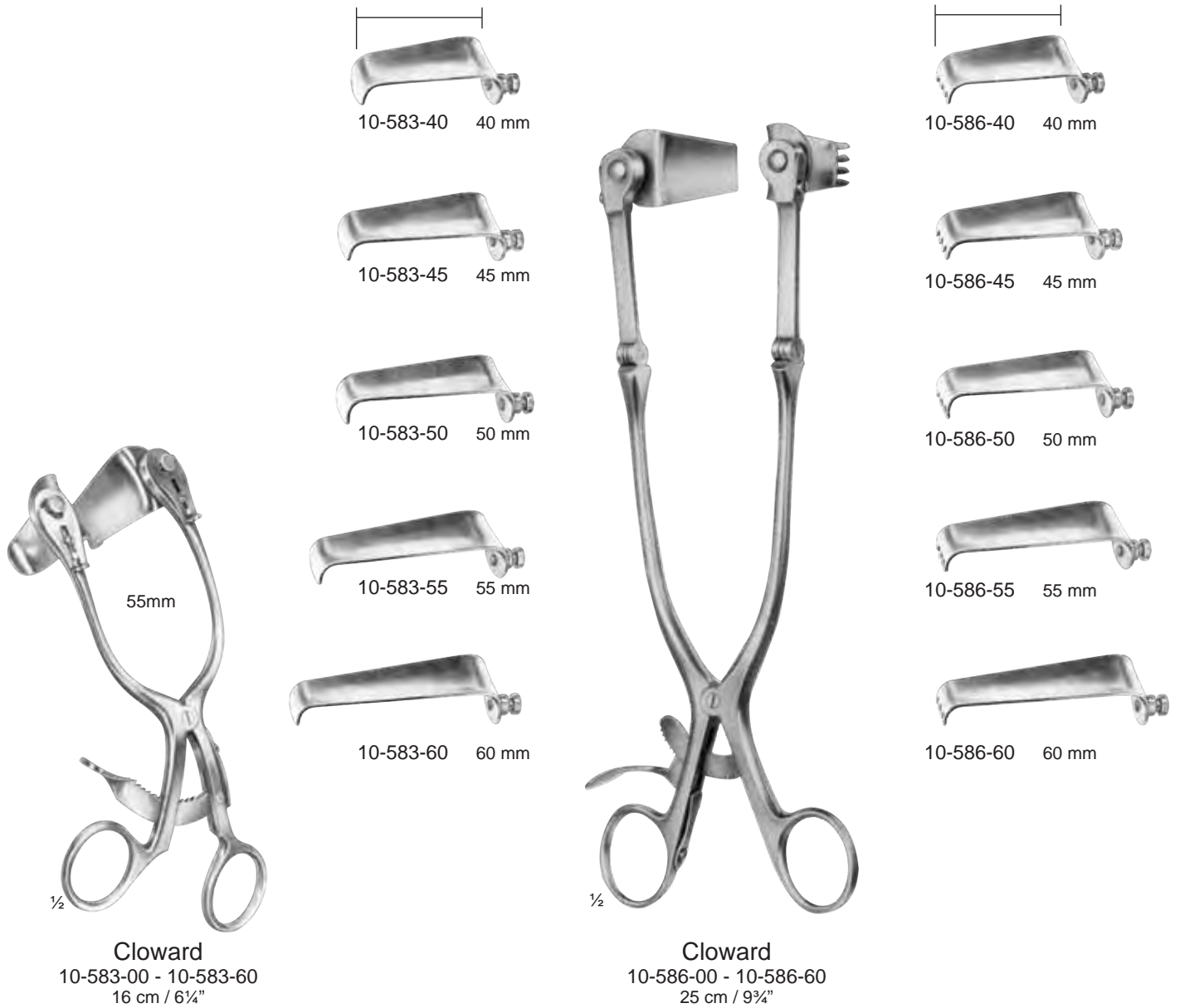

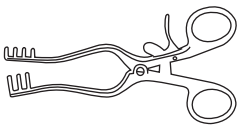

Self-Retaining Retractors

Selbsthaltende Wundsperrer
Separadores autoestaticos

Ecarteurs autostatiques
Divaricatori autostatici



Adson
10-591-32
32 cm / 12½"
4:5 teeth



Beckmann
10-594-31
31cm / 12¼"
4:4 teeth

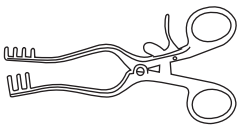

Self-Retaining Retractors

Selbsthaltende Wundsperrer
Separadores autoestaticos

Ecarteurs autostatiques
Divaricatori autostatici

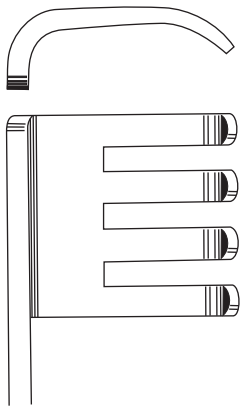

10-598-00
blunt

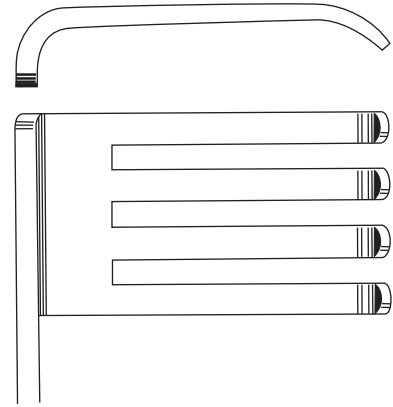

10-598-02
blunt

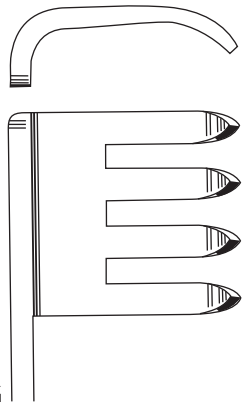

¼
10-598-01
sharp

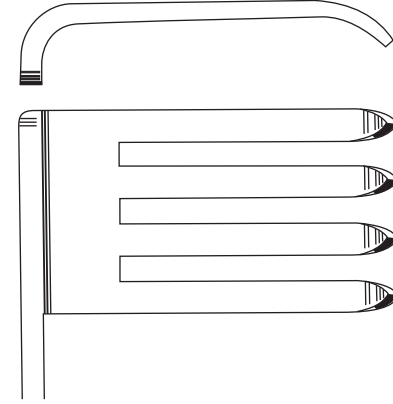

10-598-03
sharp



½

Beckmann-Adson
10-598-00 - 10-598-03
31cm / 12¼"
4:4 teeth

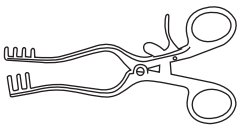

Self-Retaining Retractors

Selbsthaltende Wundsperrer
Separadores autoestaticos

Ecarteurs autostatiques
Divaricatori autostatici

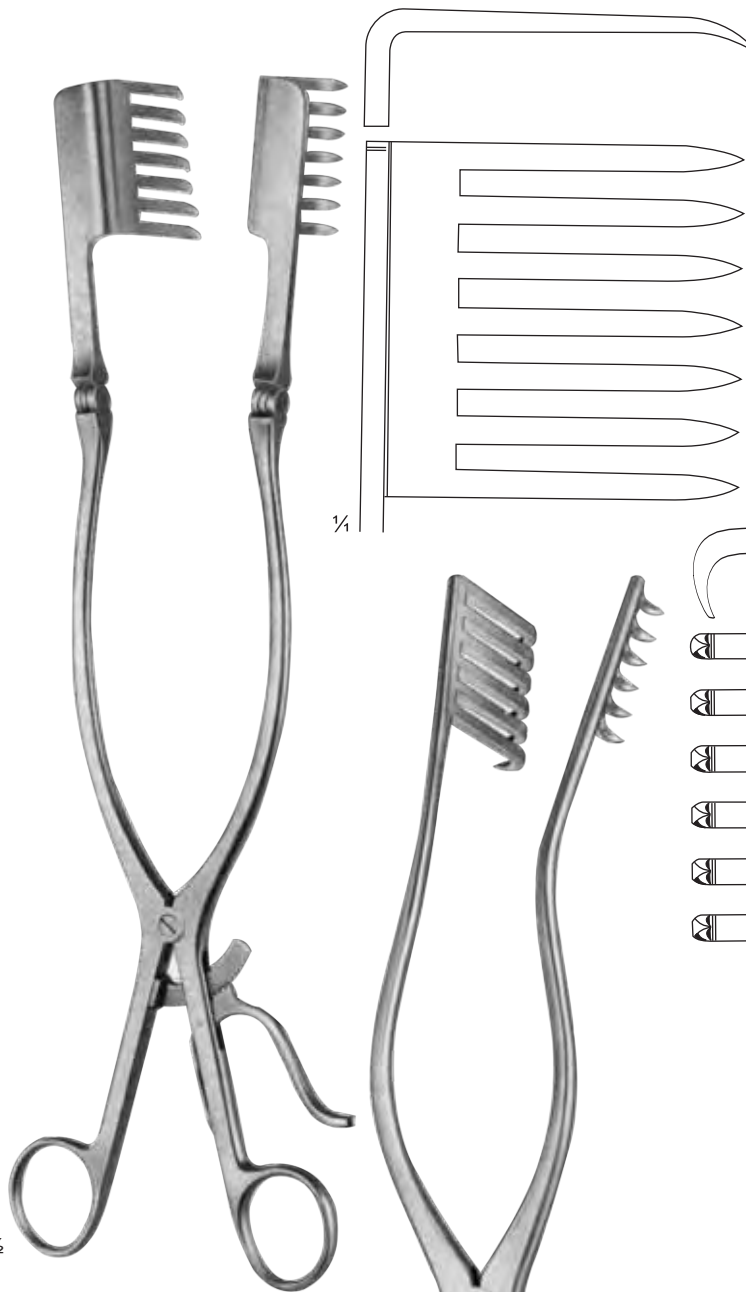

Beckmann-Eaton
10-602-32
32 cm / 12½"

Adson
10-604-01 - 10-604-02
27 cm / 10¾"
6:6 teeth

10-604-01
left

10-604-02
Right

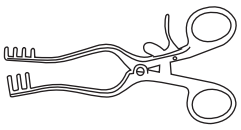

Self-Retaining Retractors

Selbsthaltende Wundsperrer
Separadores autoestaticos

Ecarteurs autostatiques
Divaricatori autostatici

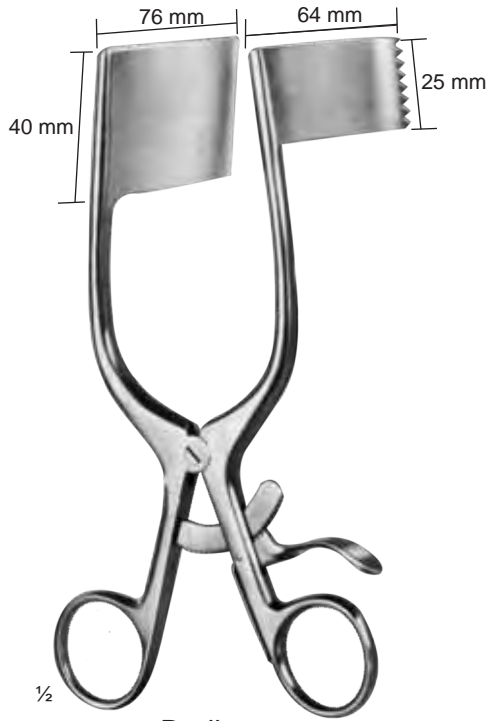

Darling
10-610-01
18 cm / 7"



Darling
10-610-02
18 cm / 7"



Gelpi
10-612-09 - 10-612-19
9 cm / 3½" 10-612-09
11 cm / 4¼" 10-612-11
14 cm / 5½" 10-612-14
19 cm / 7½" 10-612-19

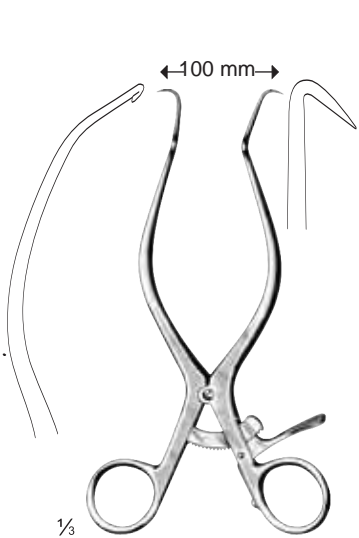

Gelpi-Loktite
10-614-18
18 cm / 7"



Gelpi-Loktite
10-616-18
18 cm / 7"



Gelpi-Seiletz
10-619-15
15 cm / 6"

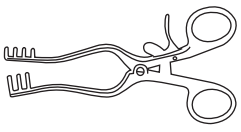

Self-Retaining Retractors

Selbsthaltende Wundsperrer
Separadores autoestaticos

Ecarteurs autostatiques
Divaricatori autostatici



1/2

Scalp Contour
10-623-14 - 10-625-14
14 cm / 5 1/2"

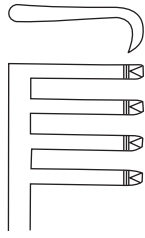

10-623-14
sharp
3:4

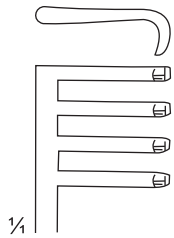

10-625-14
blunt
3:4



Adson

10-628-20 sharp
20 cm / 8"

10-629-20 blunt

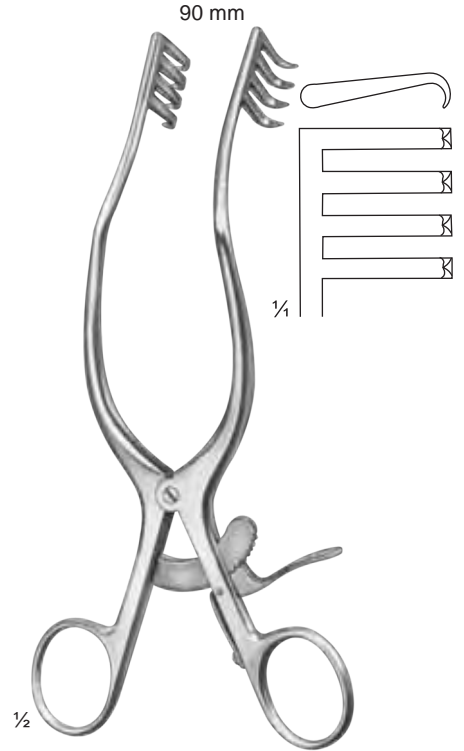

1/2

Anderson-Adson

10-631-20
19.5 cm / 7 3/4"
4 x 4 teeth



1/2

Miskimon

10-634-22 sharp
22 cm / 8 3/4"

10-635-22 blunt



1/2

Schuhknecht

10-638-14 sharp
14 cm / 5 1/2"

10-639-14 blunt



1/2

Wullstein
sharp

10.5 cm / 4 1/4"
13 cm / 5"
16 cm / 6 1/4"

blunt

10-642-10
10-642-13
10-643-10
10-643-13
10-643-16

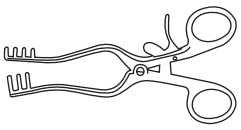

Self-Retaining Retractors

Selbsthaltende Wundsperrer
Separadores autoestaticos

Ecarteurs autostatiques
Divaricatori autostatici



25 x 25 mm

Markham-Meyerding
10-647-01
18 cm / 7"



25 x 25 mm

Markham-Meyerding
10-647-02
18 cm / 7"



Meyerding

20cm/8"
32 x 25 mm 10-652-01
54 x 25 mm 10-652-02
60 x 19 mm 10-652-03
60 x 25 mm 10-652-04

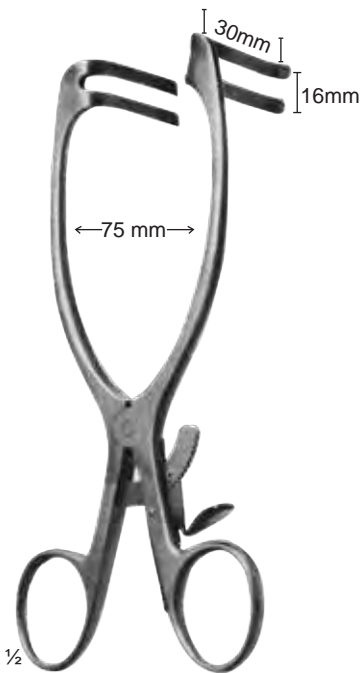

Mayo-Adams
10-654-17
17 cm / 6 3/4"

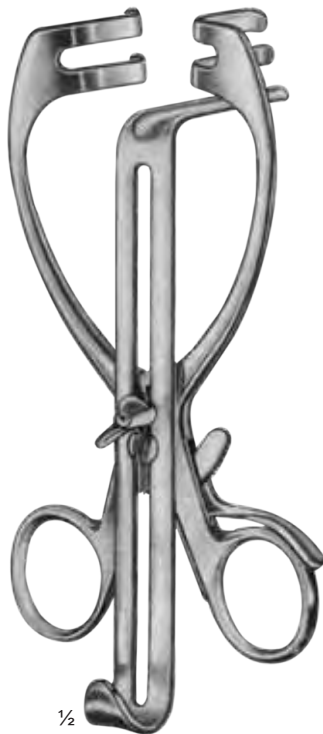

Mayo-Adams
10-656-17
17 cm / 6 3/4"



Milligan
10-658-13 sharp 13 cm / 5"
10-659-13 blunt



Foote
10-661-18
18 cm / 7"

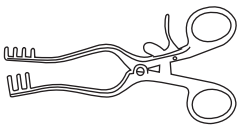

Self-Retaining Retractors

Selbsthaltende Wundsperrer
Separadores autoestaticos

Ecarteurs autostatiques
Divaricatori autostatici



Tübinger

10-666-16 10-666-18
16.5 cm / 6½" 18 cm / 7"



Rigby
18 cm / 7"

35 x 20 mm 10-668-01
60 x 20 mm 10-668-02
65 x 15 mm 10-668-03



Perkins
10-670-13
13 cm / 5"



Perkins
10-671-13
13 cm / 5"



Plester-R

10-673-10 10-673-13
10 cm / 4" 13 cm / 5"
Blunt Blunt



Plester-L

10-676-10 10-677-13
10 cm / 4" 13 cm / 5"
Blunt Blunt



Plester

10-678-10 10-678-13
10 cm / 4" 13 cm / 5"
Blunt Blunt

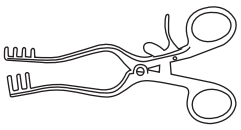

Self-Retaining Retractors

Selbsthaltende Wundsperrer
Separadores autoestaticos

Ecarteurs autostatiques
Divaricatori autostatici



Cone-Jafferson
10-680-26
sharp
26.5 cm / 10½"



Harvey Jackson
10-682-28
sharp
28 cm / 11"



55mm
Houzel/Lace
10-685-16
16 cm / 6¼"

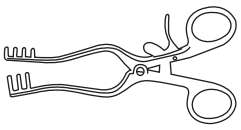

Self-Retaining Retractors

Selbsthaltende Wundsperrer
Separadores autoestaticos

Ecarteurs autostatiques
Divaricatori autostatici

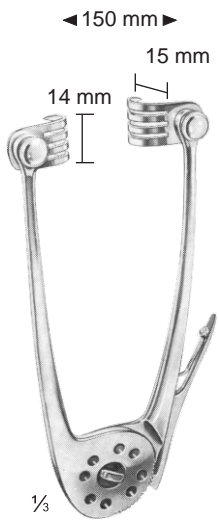

$\frac{1}{3}$
Kocher
10-688-16
16 cm / 6 $\frac{1}{4}$ "

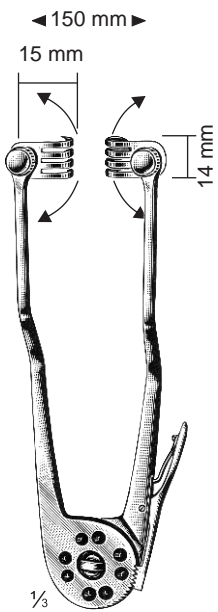

$\frac{1}{3}$
Crotti
10-690-18
18.5 cm / 7 $\frac{1}{4}$ "

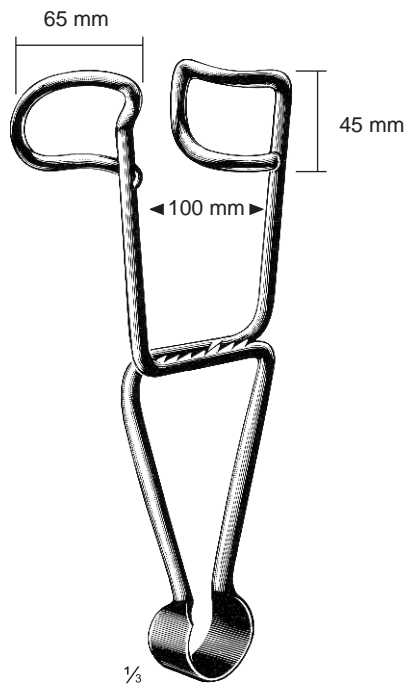

$\frac{1}{3}$
Dartigues
10-692-26
26 cm / 10 $\frac{1}{4}$ "



Comyn-Berkeley
(Vulva)
10-695-00

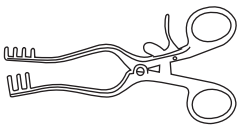

Self-Retaining Retractors

Selbsthaltende Wundsperrer
Separadores autoestaticos

Ecarteurs autostatiques
Divaricatori autostatici



1/2

Norfolk and Norwich
10-700-22
22 cm / 8 3/4"
(Blunt)



Richter
10-703-17
Vaginal Retractor
17 cm / 6 3/4"

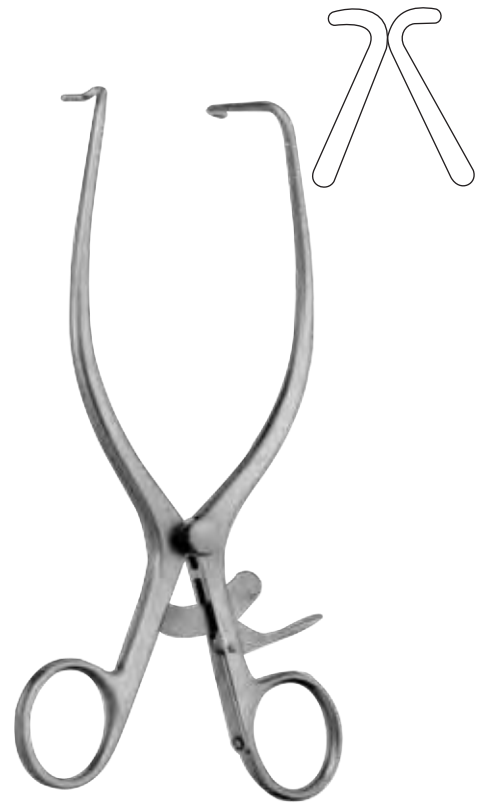

Jackson Burrows
10-705-18
blunt
18.5 cm / 7 1/4"



Travers
10-708-21
21 cm / 8 1/4"



Irwin
10-711-17
sharp
17.5 cm / 7"



Joll (Friedman)
10-713-15
Thyroid-and vaginal retractor
15.5 cm / 6"

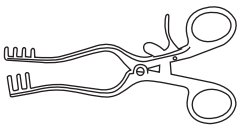

Abdominal Retractors

Bauchdeckenhalter
Separadores abdominales

Ecarteurs abdominaux
Divaricatori addominali



Blade only

Doyen

- 10-719-01 = 55 X 095 mm
- 10-719-02 = 55 X 105 mm
- 10-719-03 = 55 X 115 mm
- 10-719-04 = 55 X 125 mm

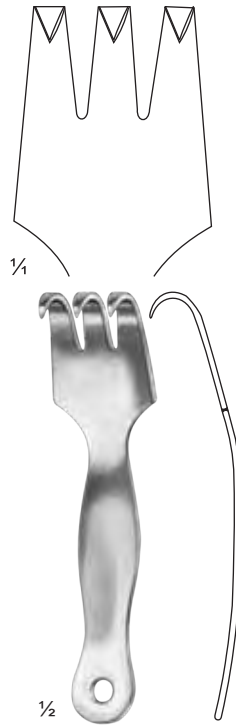

Payr.

- 10-721-03
- 10.5 cm / 4 1/4"
- 10 X 22 mm

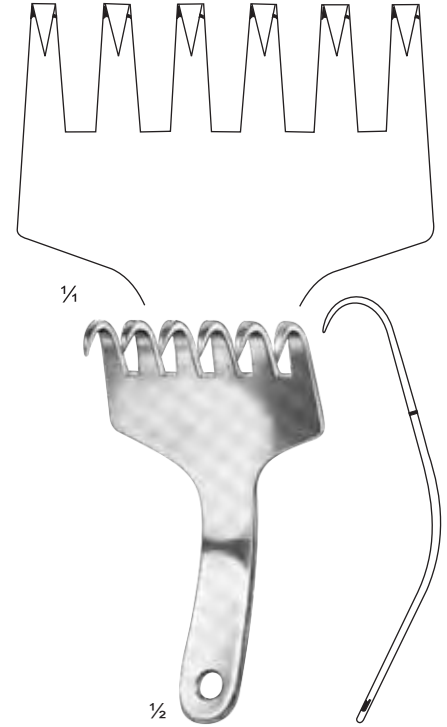

Payr.

- 10-721-06
- 10.5 cm / 4 1/4"
- 15 X 55 mm

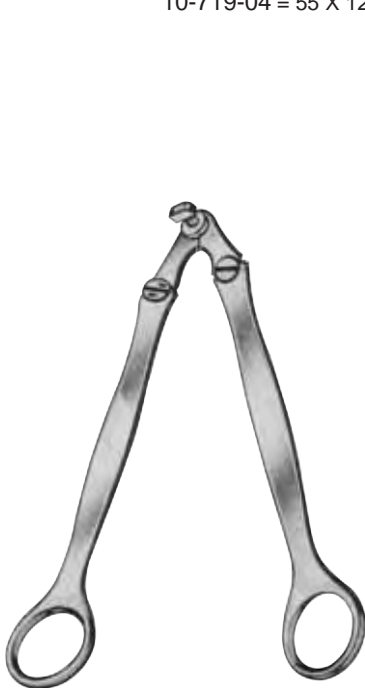

Rochar
10-724-19
19 cm / 7 1/2"

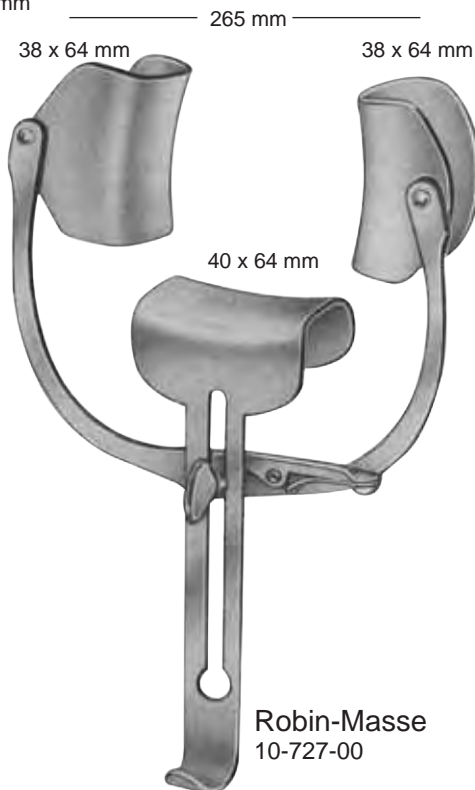

Robin-Masse
10-727-00



Oettingen
10-730-00

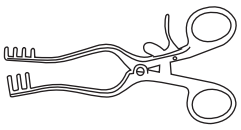

Abdominal Retractors

Bauchdeckenhalter
Separadores abdominales

Ecarteurs abdominaux
Divaricatori addominali

Exchangeable blades

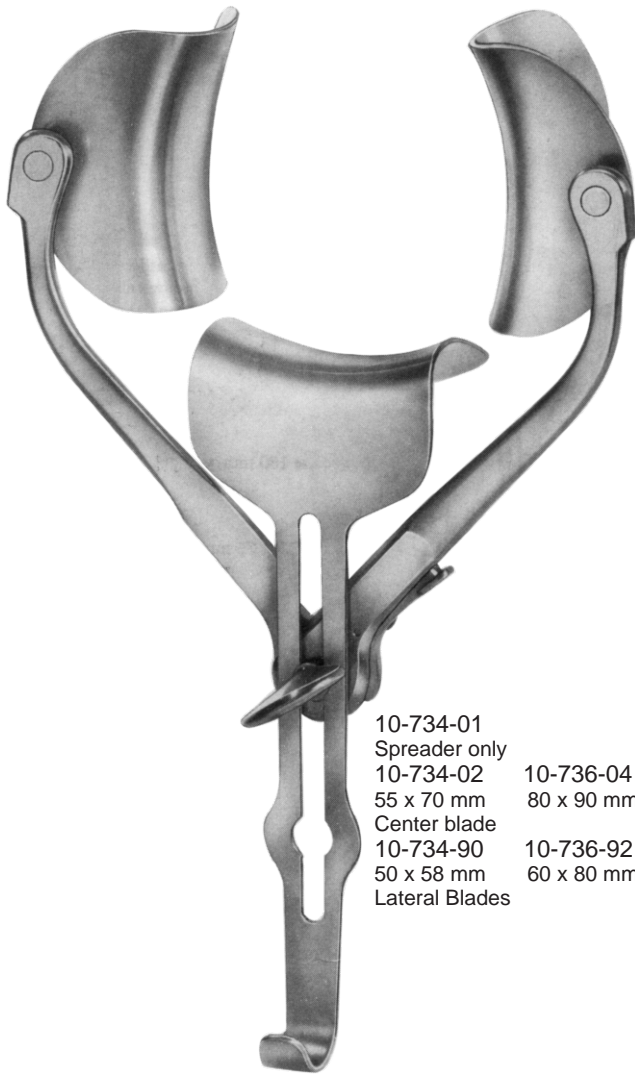

- | | | |
|----------------|------------|------------|
| 10-734-01 | 10-736-04 | |
| Spreader only | 80 x 90 mm | |
| 10-734-02 | 10-736-92 | 10-739-94 |
| 55 x 70 mm | 60 x 80 mm | 72 x 85 mm |
| Center blade | | |
| 10-734-90 | | |
| 50 x 58 mm | | |
| Lateral Blades | | |

Ricard
10-734-00
28 cm / 11"
consisting of
10-734-01
10-734-02
10-734-90
(Pair)

10-736-00
30 cm / 12"
consisting of:
10-734-01
10-736-04
10-736-92
(Pair)

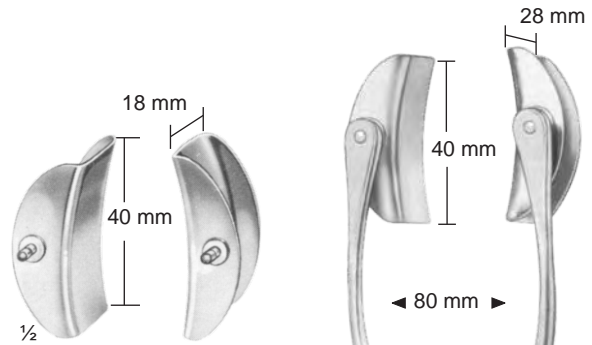

Baby-Collin
10-742-20
20 cm / 8"
complete, with 2 pairs of blades

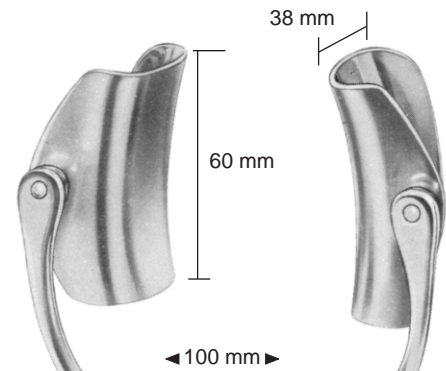

Collin
10-744-24
24 cm / 9½"
complete, with 1 pair of blades
38 x 60 mm



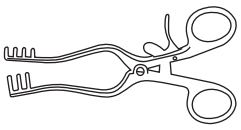

Abdominal Retractors

Bauchdeckenhalter
Separadores abdominales

Ecarteurs abdominaux
Divaricatori addominali

Exchangeable blades

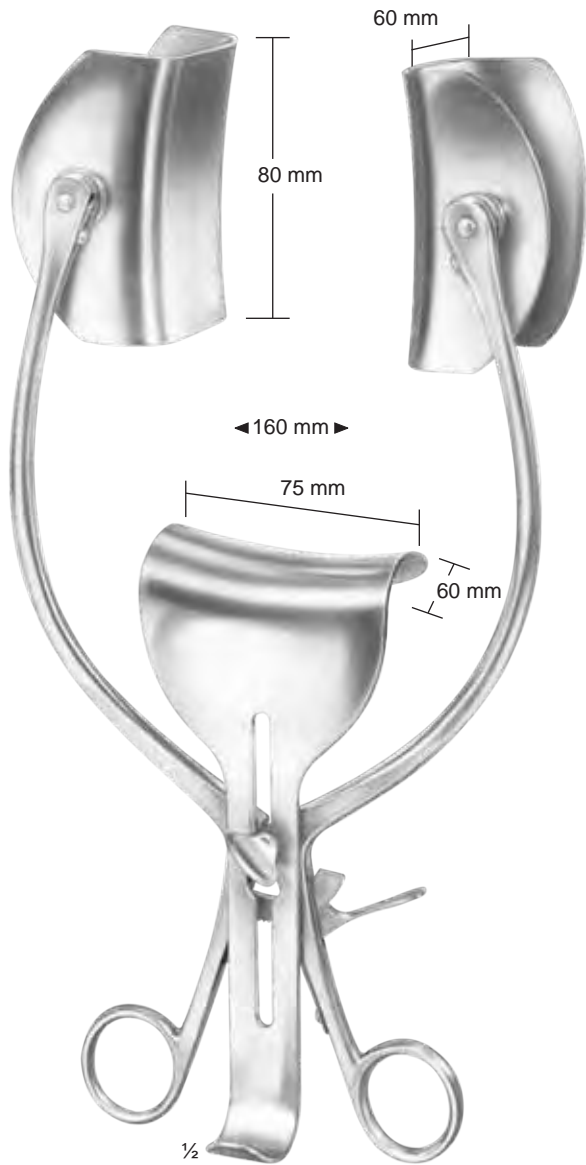

Collin-Loktite
10-750-00
31 cm / 12 1/4"



Collin
22.5 cm / 9"
10-753-00 = 38 X 60 mm / 38 X 55 mm
10-754-00 = 38 X 80 mm / 50 X 75 mm
Measurements of blades: Depth x width

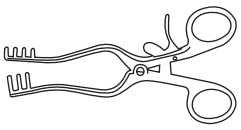

Abdominal Retractors

Bauchdeckenhalter
Separadores abdominales

Ecarteurs abdominaux
Divaricatori addominali

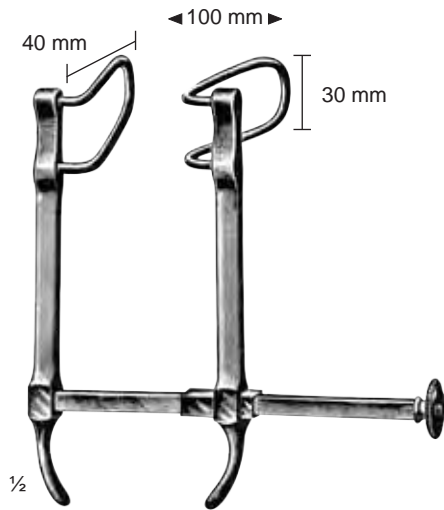

Gosset
10-762-00
12.5 cm / 5"



Gosset
10-764-00
16.5 cm / 6½"

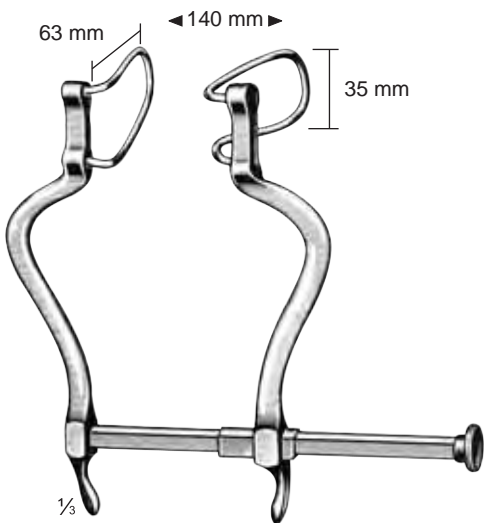

Gosset
10-766-00
18.5 cm / 7¼"

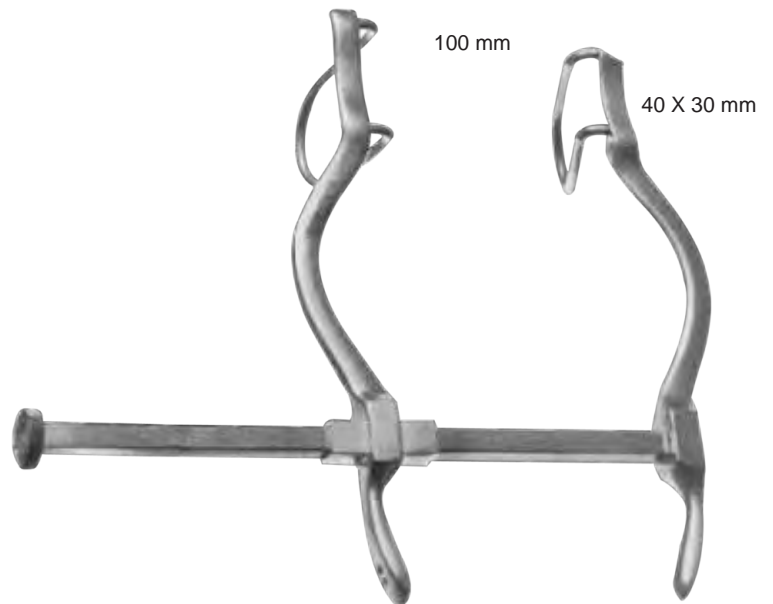

Gosset
10-769-00

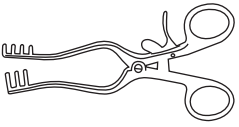

Abdominal Retractors

Bauchdeckenhalter
Separadores abdominales

Ecarteurs abdominaux
Divaricatori addominali

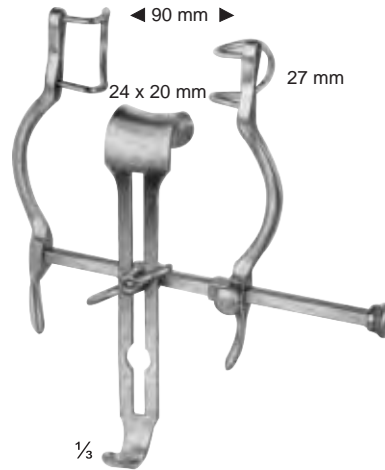

Balfour-Baby
10-772-00
12.5 cm / 5"

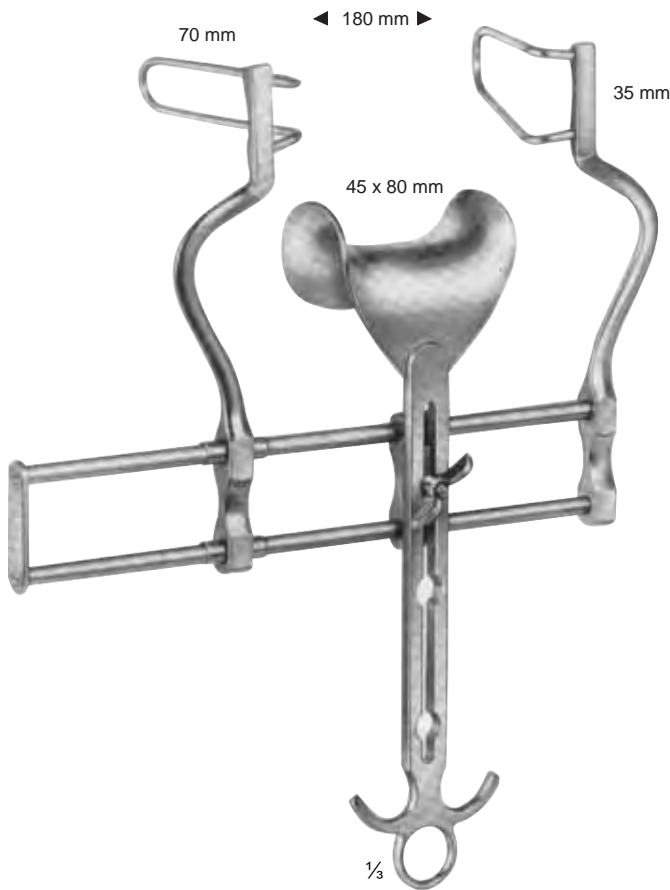

Balfour
10-774-00
20 cm / 8"

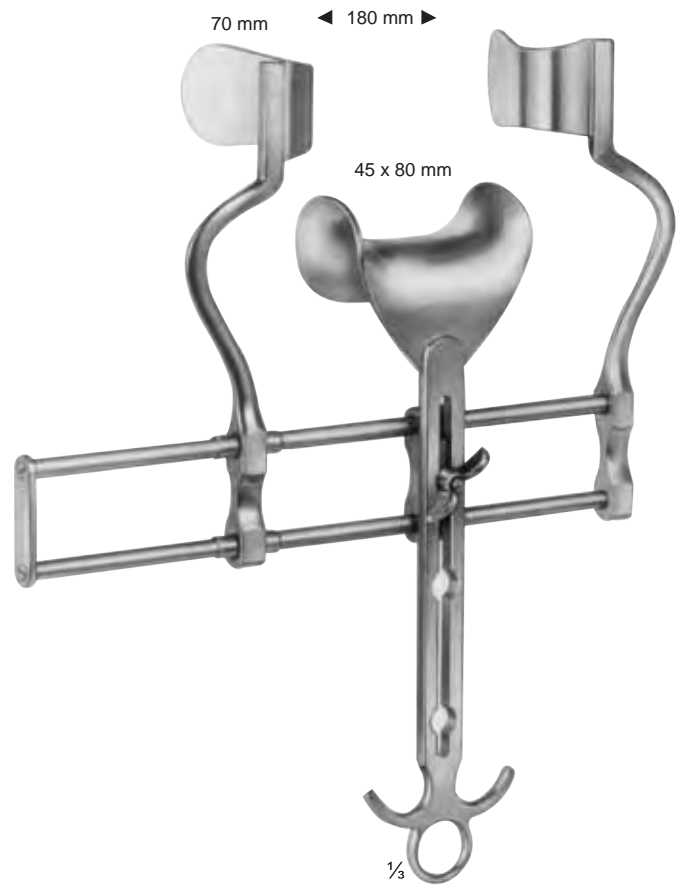

Balfour
10-776-00
20 cm / 8"

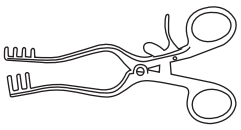

Abdominal Retractors

Bauchdeckenhalter
Separadores abdominales

Ecarteurs abdominaux
Divaricatori addominali

Centre Blade only

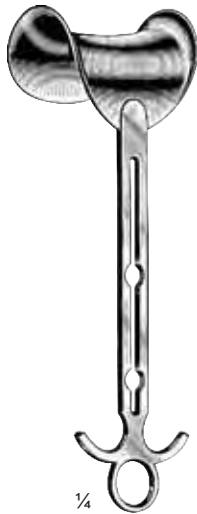

Balfour
10-781-01 = 45 X 80 mm
10-781-02 = 70 X 85 mm

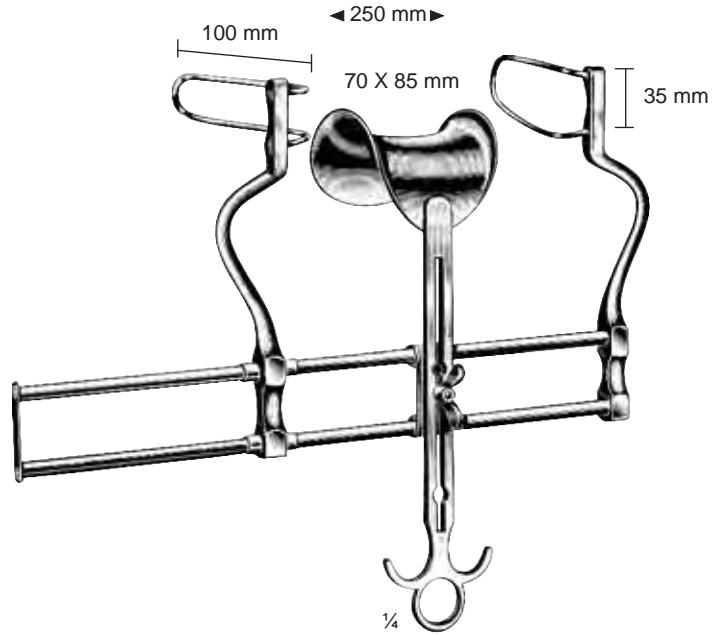

Balfour
10-784-00
20 cm / 8"

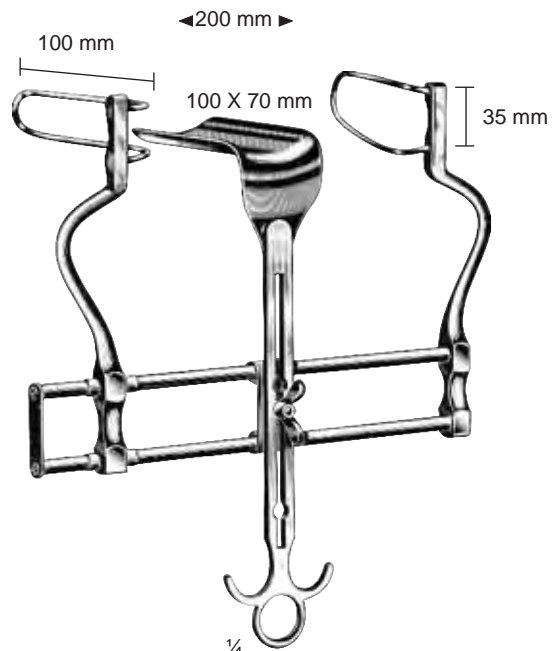

Balfour
10-786-00
20 cm / 8"

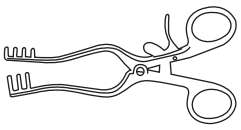

Abdominal Retractors

Bauchdeckenhalter
Separadores abdominales

Ecarteurs abdominaux
Divaricatori addominali

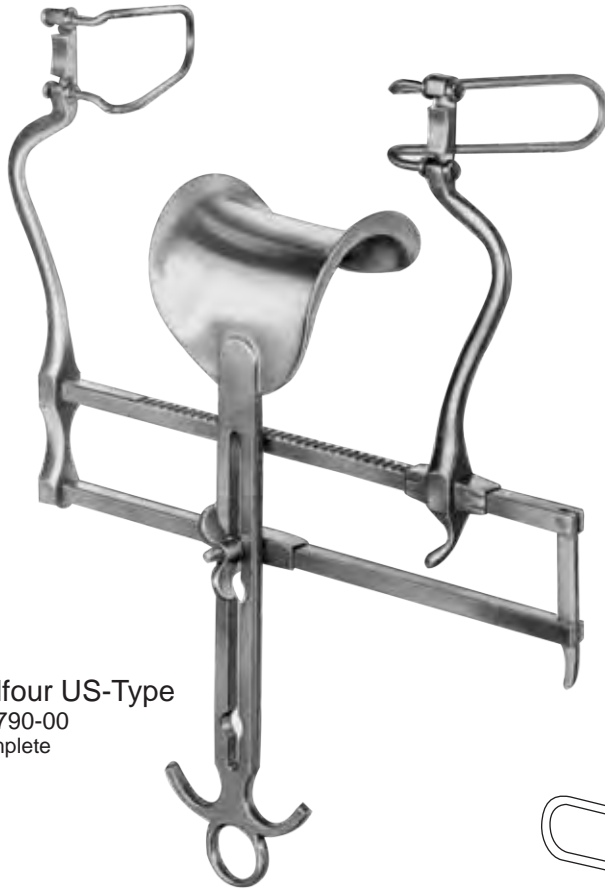

Balfour US-Type
10-790-00
Complete



10-790-06
Lateral blade, 6cm deep, per pair
10-790-08
Lateral blade 8cm deep, per pair
Measurements of blade: depth x width



10-793-05
Center blade, 68 x 85 mm
10-793-06
Center blade 40 x 68 mm

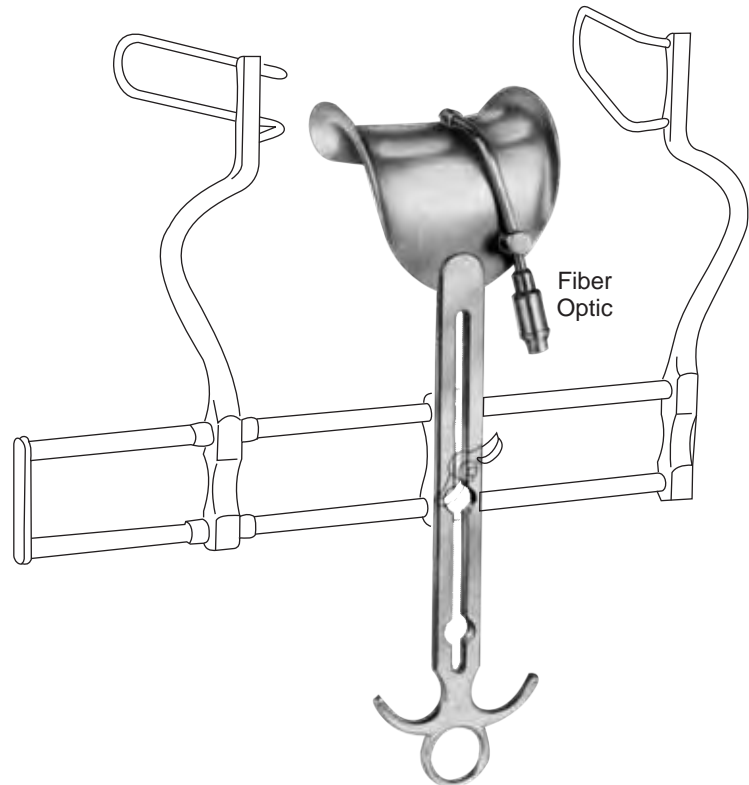

Balfour
10-793-52
70 x 85 mm
Centre Blade only

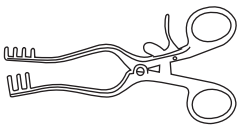

Abdominal Retractors

Bauchdeckenhalter
Separadores abdominales

Ecarteurs abdominaux
Divaricatori addominali

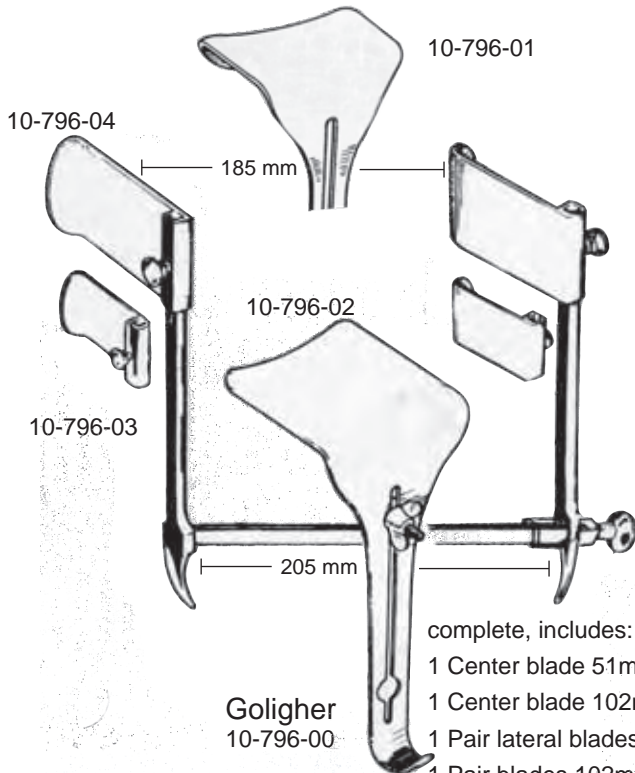

Goligher
10-796-00

- complete, includes:
- 1 Center blade 51mm deep = 10-796-00
 - 1 Center blade 102mm deep = 10-796-01
 - 1 Pair lateral blades 51mm deep = 10-796-03
 - 1 Pair blades 102mm deep = 10-796-04

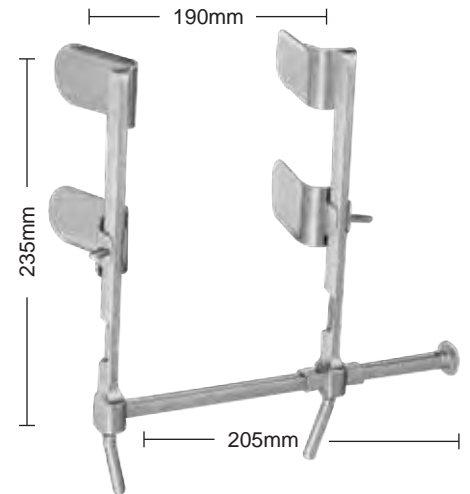

Berkeley
10-799-00
complete, with 2 fixed and
2 movable blades 60 x 35 mm

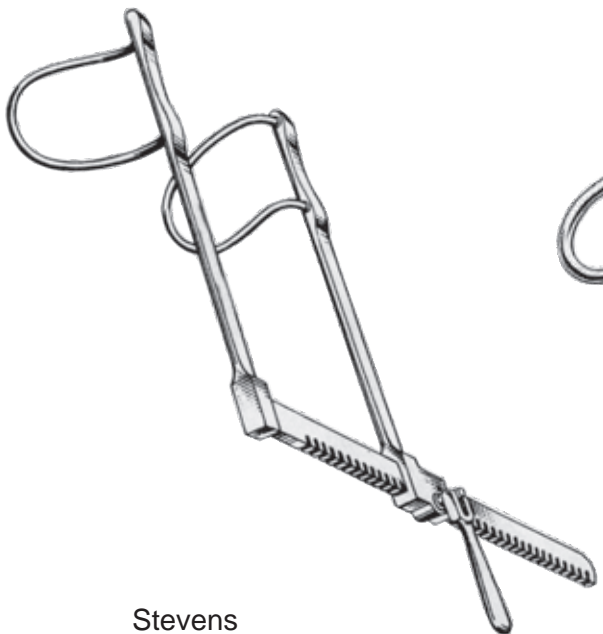

Stevens
10-802-00
blades 6 cm. deep by 4.5 cm. wide (2" x 1 3/4")
(lightweight)

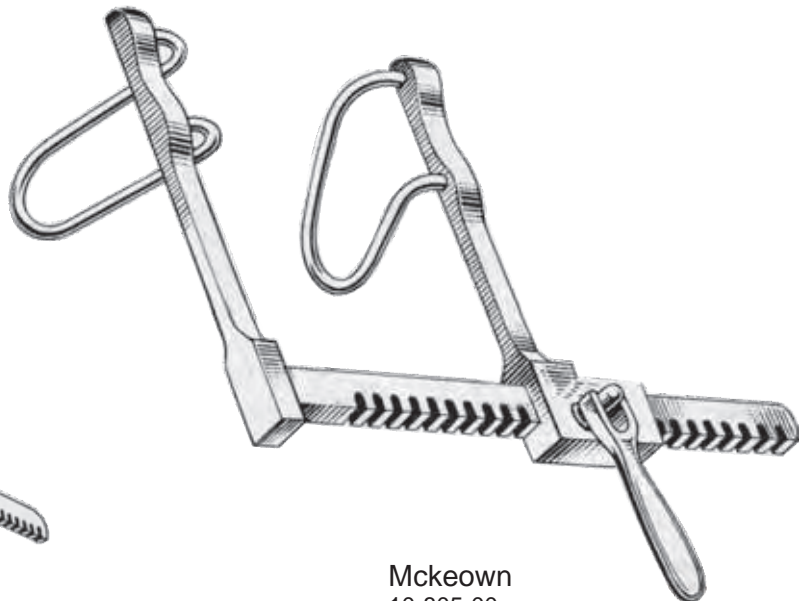

Mckeown
10-805-00
(blades 6 cm deep by
4.5 cm wide (2 1/2" x 1 3/4"))

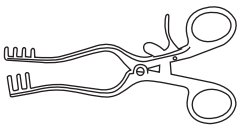

Abdominal Retractors

Bauchdeckenhalter
Separadores abdominales

Ecarteurs abdominaux
Divaricatori addominali

80 x 45 mm



10-812-03

110 x 70 mm



10-812-02

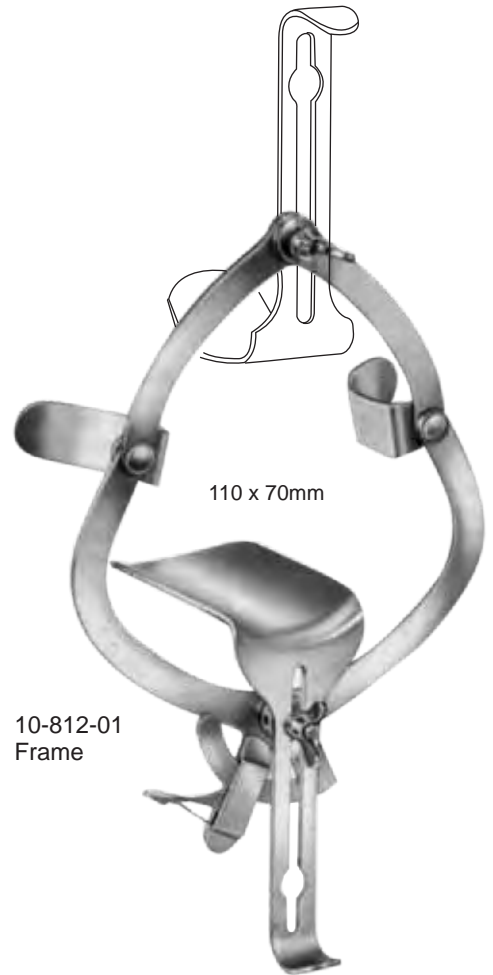

110 x 70mm

10-812-01
Frame

O'Sullivan-O'Connor

10-812-00
complete consisting out of
10-812-01 1 Frame
10-812-02 1 Blades 110 x 70 mm
10-812-03 2 Blades 80 x 45 mm

10-810-30
40 x 30 mm

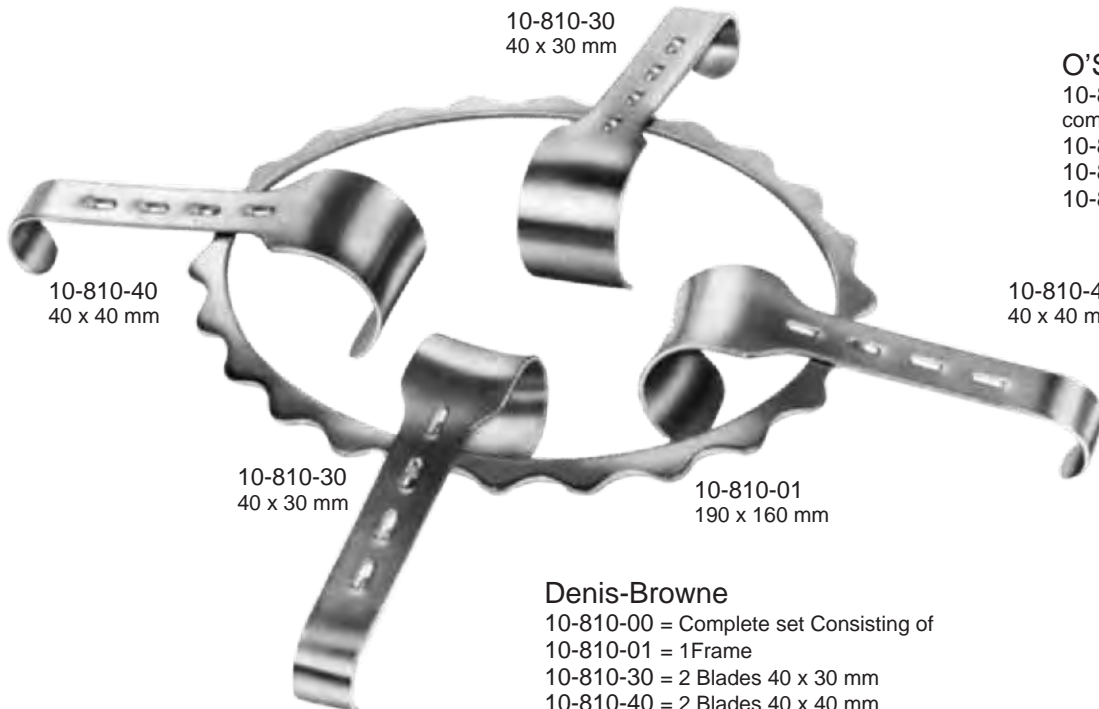

10-810-40
40 x 40 mm

10-810-30
40 x 30 mm

10-810-01
190 x 160 mm

10-810-40
40 x 40 mm

Denis-Browne

10-810-00 = Complete set Consisting of
10-810-01 = 1Frame
10-810-30 = 2 Blades 40 x 30 mm
10-810-40 = 2 Blades 40 x 40 mm

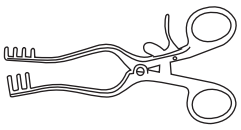

Abdominal Retractors

Bauchdeckenhalter
Separadores abdominales

Ecarteurs abdominaux
Divaricatori addominali

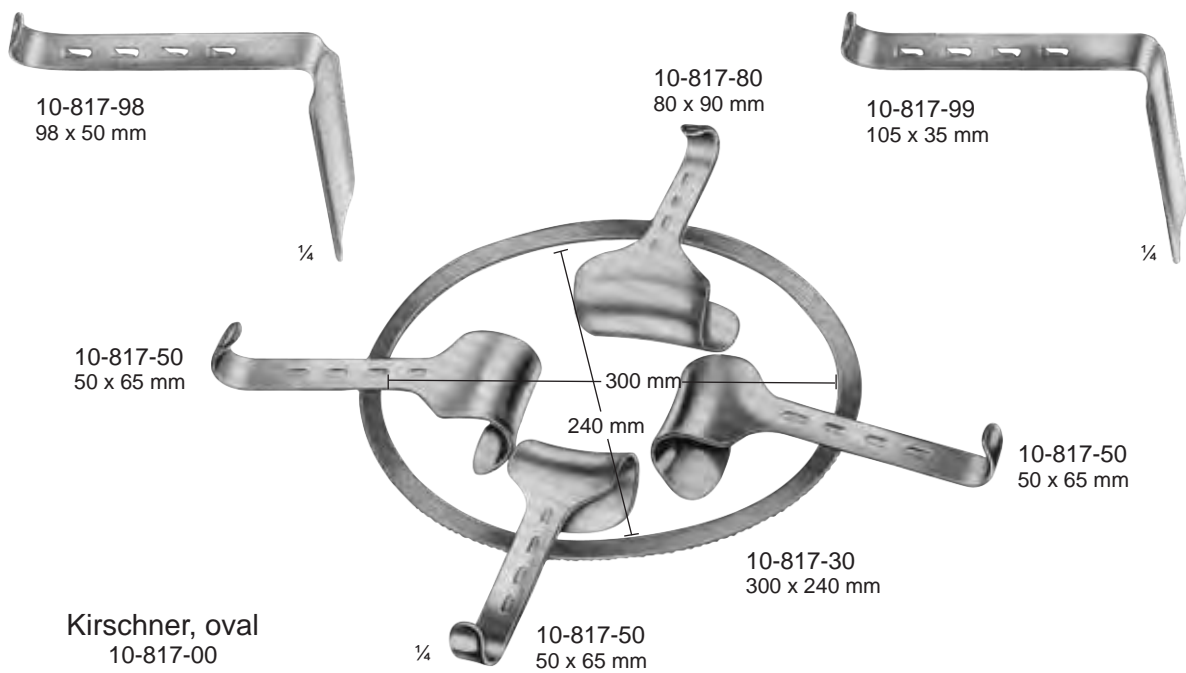

- 10-817-00** - **Kirschner** Abdominal Retractor, oval, complete, consisting of:
- 10-817-30 - 1 Frame, 300 x 240 mm
 - 10-817-50 - 3 Hook-on retractors, 50 x 65 mm
 - 10-817-80 - 1 ditto, 80 x 90 mm
 - 10-817-98 - 1 ditto, 98 x 50 mm
 - 10-817-99 - 1 ditto, 105 x 35 mm

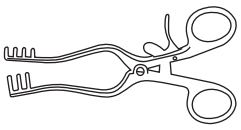

Abdominal Retractors

Bauchdeckenhalter
Separadores abdominales

Ecarteurs abdominaux
Divaricatori addominali

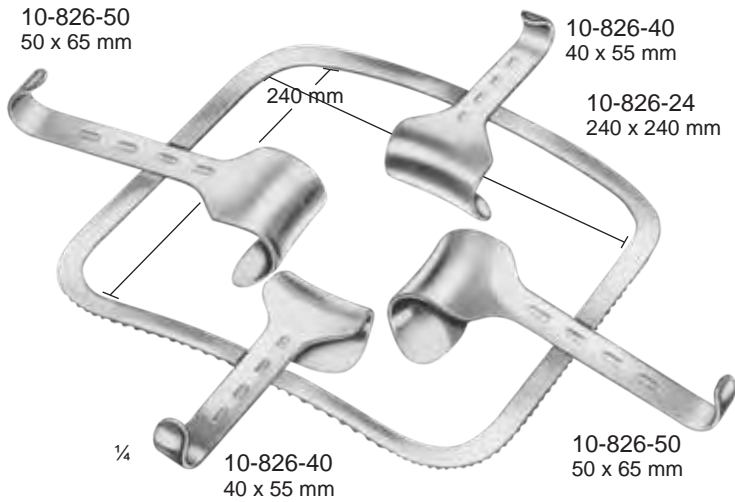

Kirschner
10-826-00

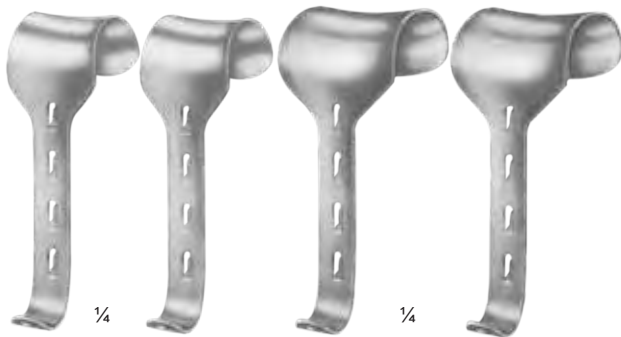

10-826-40
40 x 55 mm

10-826-50
50 x 65 mm

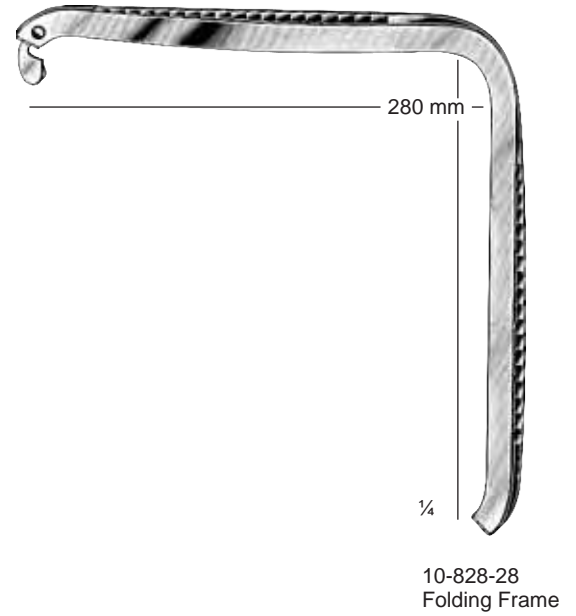

10-828-28
Folding Frame



10-828-78
76 x 65 mm

10-828-80
80 x 90 mm

- 10-826-00** - Kirschner Abdominal Retractor, complete, consisting of:
 10-826-24 - Frame, rigid, 240 x 240 mm
 10-826-40 - 2 Hook-on Retractors, 40 x 55 mm
 10-826-50 - 2 ditto, 50 x 65 mm

- 10-828-00 Kirschner Abdominal retractor Complete Consisting of
 10-828-28 1 Frame. folding type, large size 280 x 280 mm
 10-826-40 2 Hook-on Retractors, 40 x 55 mm
 10-826-50 2 ditto, 50 x 65 mm

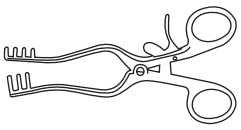

Abdominal Retractors

Bauchdeckenhalter
Separadores abdominales

Ecarteurs abdominaux
Divaricatori addominali

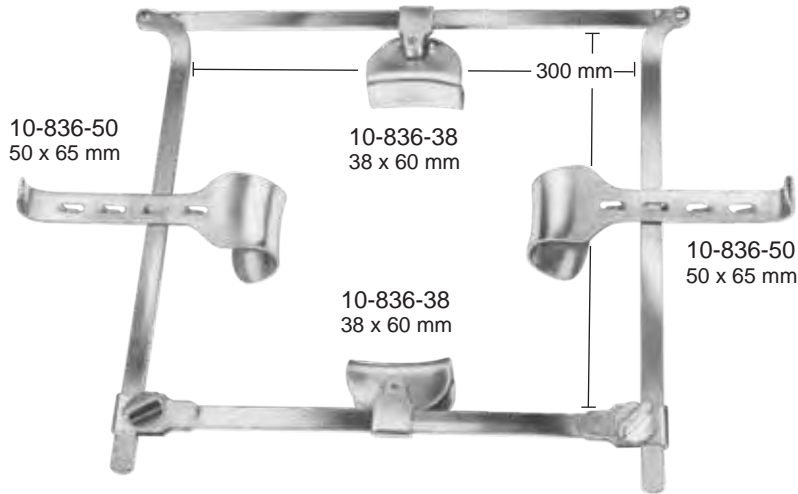

Franz (complete)
10-836-00 10-838-00
with 4 blades with 8 blades



10-836-30
300 x 300 mm

Folding frame

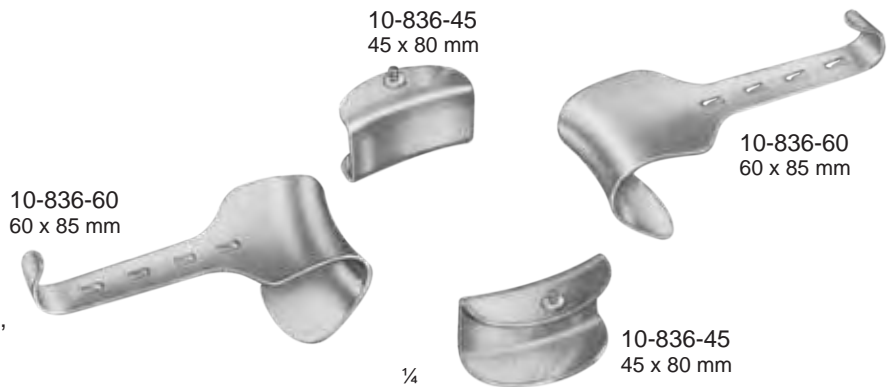

- 10-836-00** - Franz Abdominal Retractor, folding, complete, consisting of:
10-836-30 - 1 frame, folding, 300 x 300 mm
10-836-38 - 2 hook-on retractors, 50 x 65 mm
10-836-50 - 2 exchangeable blades 38 x 60 mm
- 10-838-00** - Franz Abdominal Retractor, folding, complete, consisting of:
10-836-30 - 1 frame, folding, 300 x 300 mm
10-836-50 - 2 hook-on retractors, 50 x 65 mm
10-836-60 - 2 ditto, 60 x 85 mm
10-836-38 - 2 exchangeable blades, 38 x 60 mm
10-836-45 - 2 ditto, 45 x 80 mm

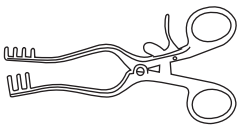

Abdominal Retractors

Bauchdeckenhalter
Separadores abdominales

Ecarteurs abdominaux
Divaricatori addominali

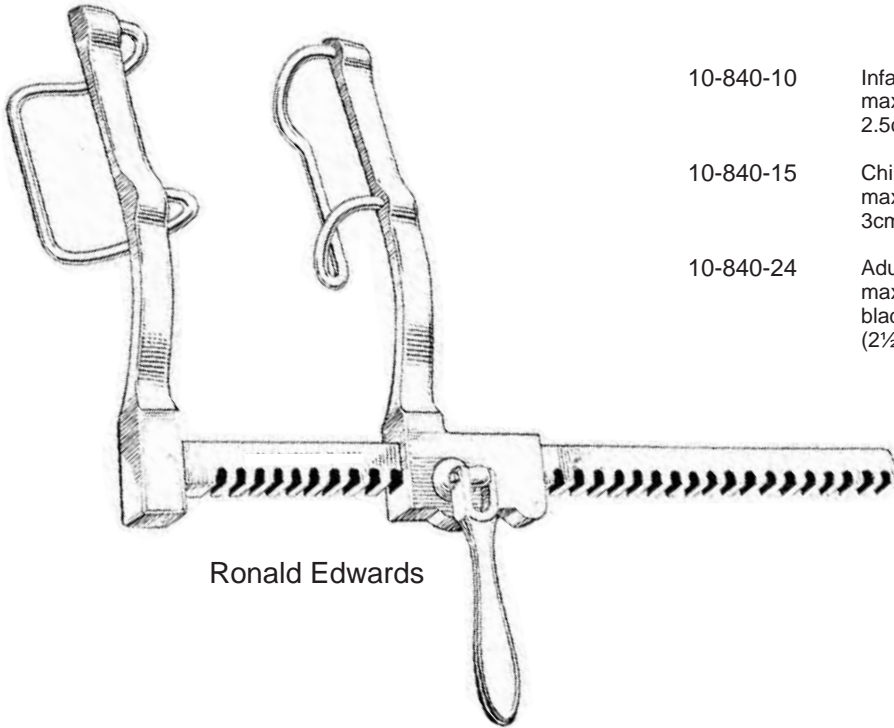

Ronald Edwards

- 10-840-10 Infant
maximum expansion 10cm. (4") blades
2.5cm. deep x 3cm wide (1" x 1¼")
- 10-840-15 Child
maximum expansion 15cm. (6in) blades
3cm deep x 5cm. wide (1¼" x 2")
- 10-840-24 Adult
maximum expansion 24.5cm (9¼")
blades 6.5cm. deep x 7.5cm. wide
(2½" x 3")

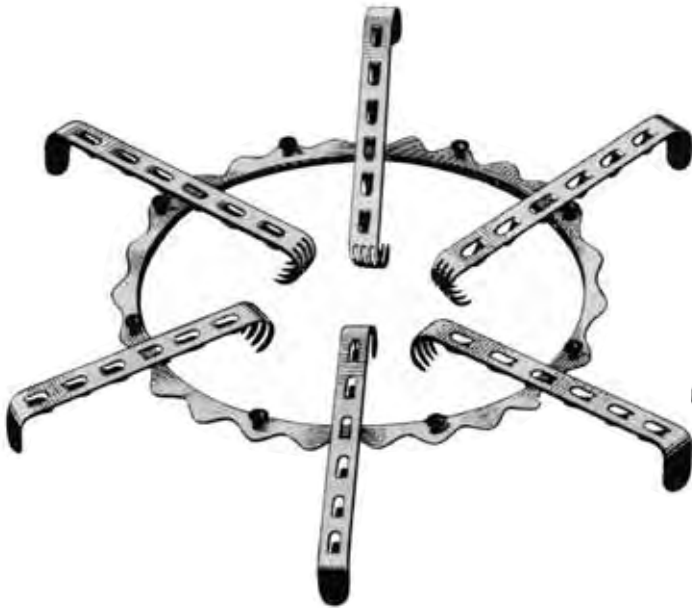

Turner-Warwick

- 10-842-00 Comprising:
- 10-842-01 Sprocket Frame, with studs, 18cm
14cm (7" x 5½") internal dimensions.
- 10-842-02 Curved claw blade, 1.3cm x 1.3cm
(½" x ½") six in set

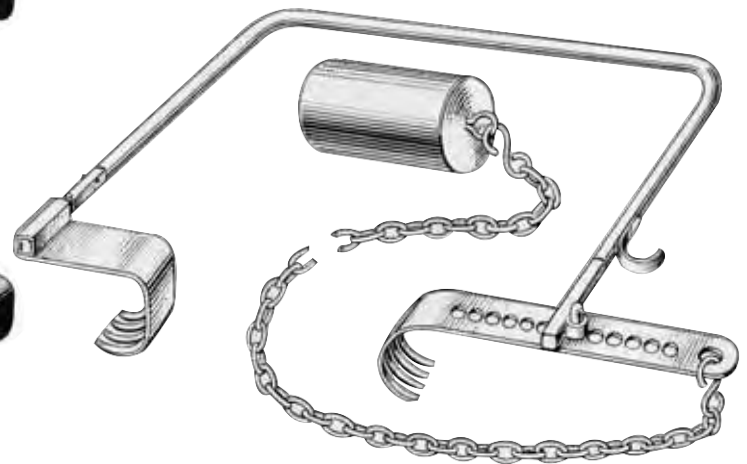

Charnley
10-846-00

Two blades and weight with chain for use with above.
Frame 24cm x 28cm (9½" x 11")
Blades 4.5cm. deep by 2.5cm, wide (1¾" x 1")
length 6.5cm (2½") and 3.5cm, deep by 2.5cm
wide (1⅜" x 1") length 18.5cm / 7¼"

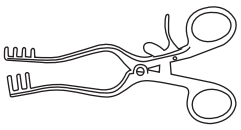

Laminectomy Retractors

Laminektomiesperrer
Separadores para laminectomía

Ecarteurs pour laminectomie
Divaricatori per laminectomia

◀ 150mm ▶

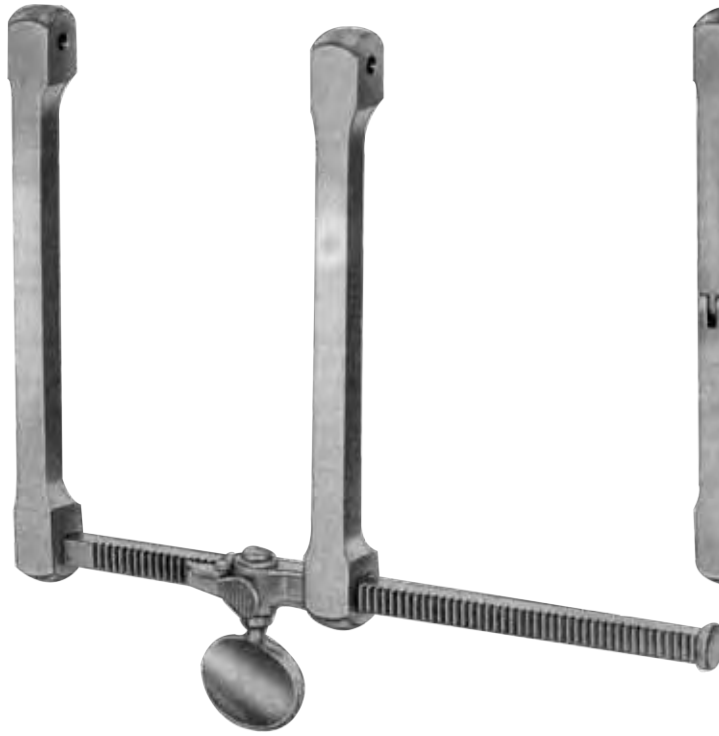

Scoville
10-854-00
Frame only

◀ 150mm ▶



Scoville-Haverfield
10-854-50
Frame only



1/2

Scoville
10-854-01
50 mm / 2"



Scoville
10-854-02
70 mm / 2 3/4"



Scoville
10-854-06
50 mm / 2"



Scoville
10-854-07
70 mm / 2 3/4"



Scoville
10-854-11 = 64 x 25 mm
10-854-12 = 64 x 50 mm
10-854-13 = 88 x 25 mm



Taylor
10-854-41 = 48 x 50 mm
10-854-42 = 64 x 50 mm
10-854-43 = 64 x 64 mm
10-854-44 = 80 x 57 mm



Scoville
10-854-46 = 41 x 38 mm
10-854-47 = 67 x 44 mm

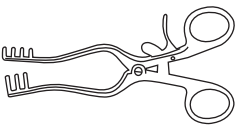

Abdominal Spatulas

Bauchspatel
Espátulas abdominales

Spatules abdominales
Spatole addominali

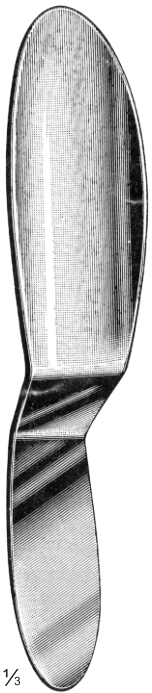

1/3

Reverdin
10-857-28
28 cm / 11"

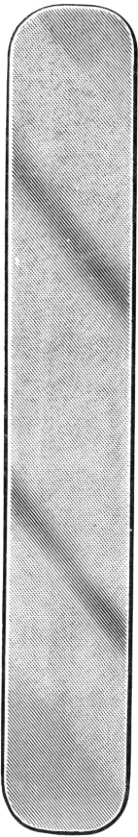

1/3

10-859-01 = 33 cm / 13", 30 mm
10-859-02 = 33 cm / 13", 40 mm
10-859-03 = 33 cm / 13", 50 mm
flexible

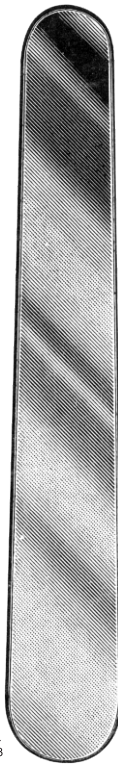

1/3

Haberer-waltan
10-861-00 = 20 cm / 8" 17/25 mm
10-861-01 = 28 cm / 11" 25/30 mm
10-861-02 = 30 cm / 11 3/4" 37/45 mm
flexible



1/3

soft width
10-863-12 = 20 cm / 8" = 12 mm
10-863-17 = 20 cm / 8" = 17 mm
10-863-25 = 20 cm / 8" = 25 mm
10-864-25 = 25 cm / 9 3/4" = 25 mm

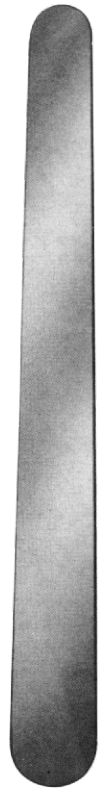

Tuffier
10-865-20
20 cm / 8"
25 x 17 mm

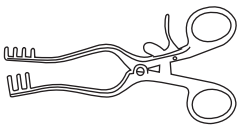

Abdominal Retractors

Bauchdeckenhalter
Separadores abdominales

Ecarteurs abdominaux
Divaricatori addominali

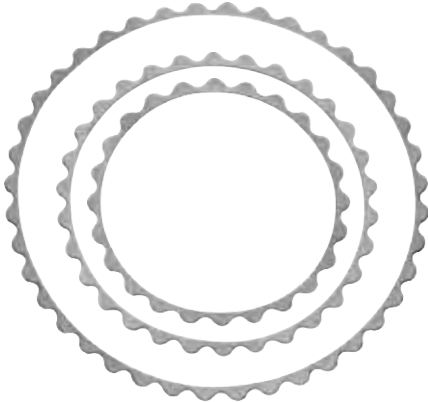

Turner-Warwick
10-872-07 = 180 mm / 7"
10-873-09 = 230 mm / 9"
10-874-12 = 305 mm / 12"
Retractor frame, round

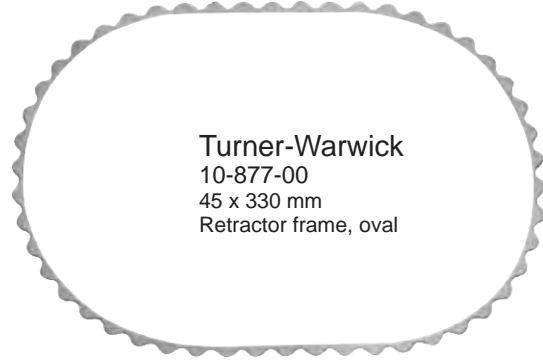

Turner-Warwick
10-877-00
45 x 330 mm
Retractor frame, oval

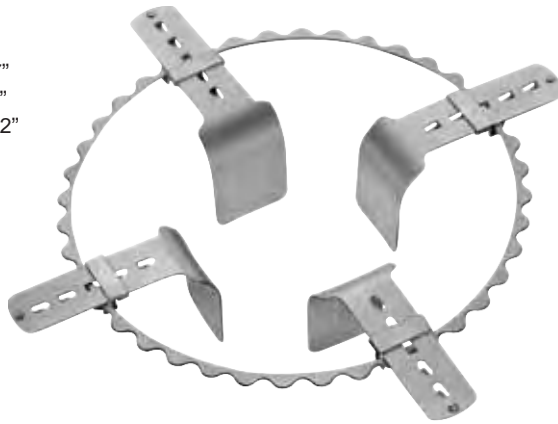

Turner-Warwick
10-879-00
Abdominal Retractor, complete

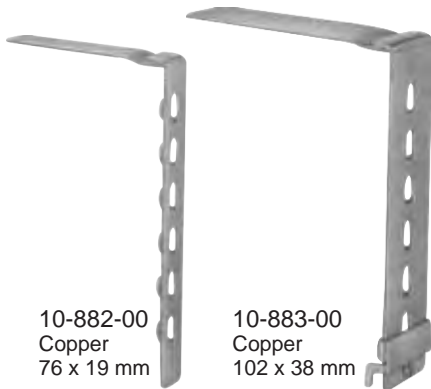

10-882-00
Copper
76 x 19 mm

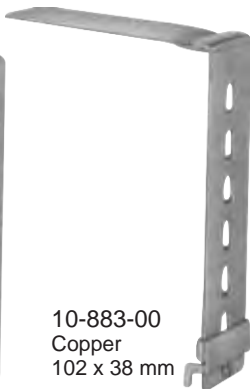

10-883-00
Copper
102 x 38 mm



10-884-00
de Cobre
89 x 57 mm

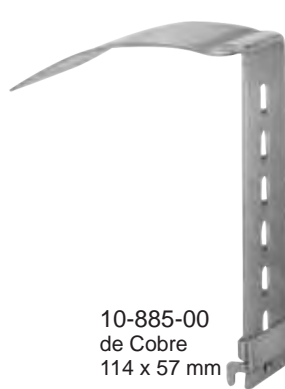

10-885-00
de Cobre
114 x 57 mm



10-886-00
de Cobre
51 x 38 mm



10-887-00
76 x 60 mm



10-888-00
89 x 60 mm



10-889-00
114 x 60 mm



10-890-00
hook 13 mm

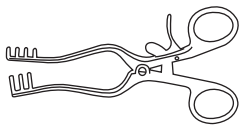

Abdominal Retractors

Bauchdeckenhalter
Separadores abdominales

Ecarteurs abdominaux
Divaricatori addominali



10-901-14

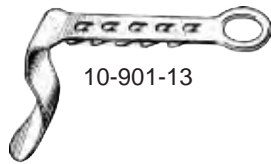

10-901-13

10-901-12

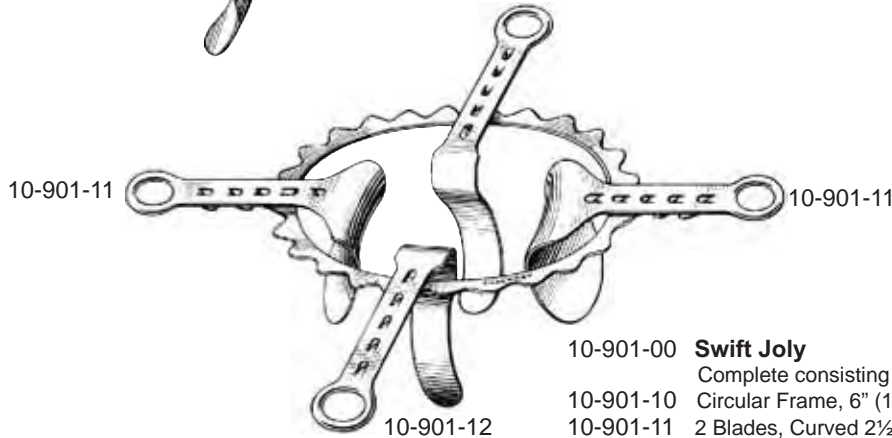

10-901-11

10-901-11

10-901-12

10-901-00 Swift Joly

Complete consisting of:

- 10-901-10 Circular Frame, 6" (152 mm) dia.
- 10-901-11 2 Blades, Curved 2½" x 2½" (64 mm x 64 mm)
- 10-901-12 2 Blades, dished, 1" x 4" (25 mm x 102 mm)
- 10-901-13 1 Blade, dished 1" x 3¼" (25 mm x 83 mm)
- 10-901-14 1 Blade, angled 1" x 2½" (25 mm x 64 mm)



10-903-14

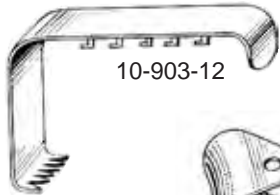

10-903-12

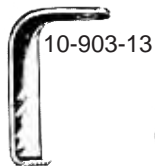

10-903-13



10-903-15

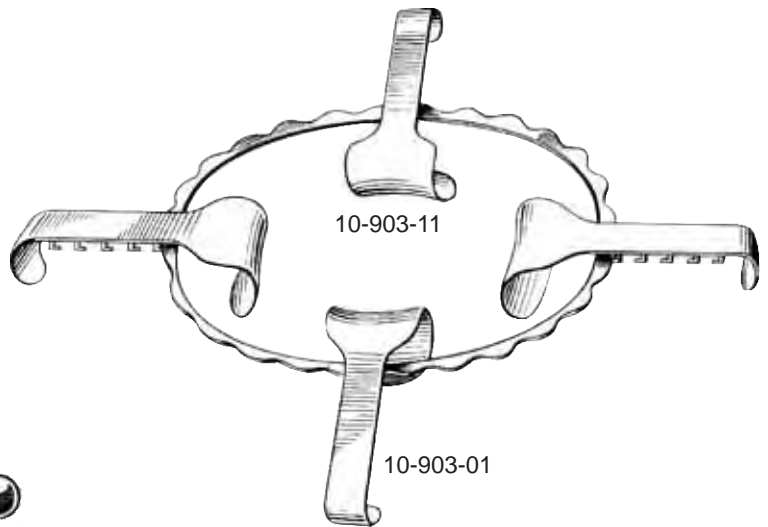

10-903-11

10-903-01



10-903-16



10-903-18



10-903-19

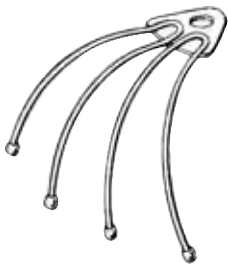

10-903-17

10-903-00 Denis Browne

Complete consisting of:

- 10-903-01 Oval Frame
- 10-903-11 4 Abdominal Blades with positioning hooks, 35mm, wide x 40mm. deep.
- 10-903-12 4 Angled Blades with toothed ends, 20mm, wide x 50mm, deep.
- 10-903-13 4 Claw Blades, curved, 12.5mm, wide.
- 10-903-14 2 Sharp Hook Retractors.
- 10-903-15 1 adjustable arm and screw to take detachable Blade.
- 10-903-16 Abdominal Blade to fit adjustable arm 10-903-19 35mm, wide x 35mm. deep.
- 10-903-17 Lung Retractor, malleable wire to fit adjustable arm F.
- 10-903-18 Spanner to fit shaft
- 10-903-19 Shaft for ends 10-903-16 , 10-903-17

